

**INCOVE**®

**INCOVE VEDAÇÕES LTDA.**

2º Edição

Copyright by

**INCOVE VEDAÇÕES LTDA.**

Nenhuma parte desta obra pode ser reproduzida sem  
autorização expressa dos detentores do copyright.



## INTRODUÇÃO CATÁLOGO INCOVE

O campo de vedadores e gaxetas é muito vasto. Seria presunção conseguir num único catálogo oferecer cobertura completa. Este catálogo não tem a pretensão de ser completo, porém tentamos nesta edição agrupar o maior número possível de informações com o intuito de beneficiar e auxiliar o dia-a-dia de nossos clientes, compradores e consulentes em geral.

Procuramos apresentar os vários aspectos de vedadores, materiais de vedação e vedação de fluídos sob tópicos lógicos, coerentes com a moderna terminologia e a moderna maneira de abordar o projeto e a seleção de peças de vedação. Esperamos apresentar uma imagem clara das características e aplicações dos diferentes tipos de vedação, primordialmente como base de seleção para uso e em especial as possíveis limitações.

**DADOS CADASTRAIS**

Ramo de atividade  
Indústria e Comércio de Artefatos de Borracha - Cód. 2519-4  
Área de Atuação  
Mercado Interno - Todo Território Nacional  
ESCRITÓRIO / VENDAS  
Razão Social: Incove Vedações Ltda.  
Endereço: Rua Barão de Campinas, 452 - Campos Elíseos  
Município: São Paulo / SP  
CEP 01201-000  
Internet: [www.incove.com.br](http://www.incove.com.br) / [incove@incove.com.br](mailto:incove@incove.com.br)  
Telefone: 11 3331-3177  
Fax: 11 3221-2246 / 3222-0339

**Produtos de nossa fabricação:**

Retentores, Gaxetas (U, V, Copo), Anéis, O' rings,  
Jogos Compostos (Chevron), Reparos de Kits,  
Peças Especiais, Trafilados e Usinados.

**Matérias primas disponíveis:**

Natural, Nitrílica, Neoprene, (W), Epdm, Poliuretano,  
Hypalon, Silicone (Dow Corning), Viton (Du pont),  
Incovepreme (Uretano Prensado), Teflon (Du pont),  
Nylon, Pvc, Plástico, Celeron e Couro.

**Produtos de Distribuição:**

Sabó, Orion.







Página

2

KR  
Kits e Reparos

Página

6

Mecanismos  
de vedação

Página

8

Manutenção  
e materiais

Página

16

Tabelas



Retentores

Página

18

Gaxetas

Página

121

Página

219

Anéis





Página **Coxim**  
**295**

Diafragma  
Página **295**

Trefilados  
Página **296**

Ventosa  
Pág. **296**

Carretel  
Pág. **297**

AUP  
Pág. **297**

Tarugo, Esfera, Sanfona e Acoplamento  
Pag. **298**

Arruelas  
Página **255**

Buchas  
Página **269**

Raspadores e Limpadores  
Página **273**

IG  
Página **281**

Quad Ring  
Página **289**

V Ring  
Página **294**

Páginas 293 e 294 Diversos





Relação dos Krs nacionalizados e desenvolvidos pela Incove.  
*Os Kits são desenvolvidos especialmente para máquinas industriais, com identificação específica para cada máquina. Consulte nosso departamento técnico para qualquer esclarecimento.*

**INCOVE**®  
INCOVE VEDAÇÕES LTDA.

**KR**  
*Kit Reparo*

## LISTA DE MATERIAIS PARA VEDADORES

Borracha Natural  
Nitrílica  
Neoprene<sup>®</sup>  
EPDM  
Silicone           vermelho (telha), branco e translúcido  
Viton<sup>®</sup>            preto, branco e marrom  
Hypalon<sup>®</sup>  
Poliacrílica  
Poliuretano  
TEFLON<sup>®</sup>        puro, grafitado, bronze e fibra de vidro  
SBR  
Couro

## PRODUTO NOVO

Perfluoroelastômero  
Indicado para as Indústrias Química, Petrolífera, Aeronáutica  
e Aeroespacial.

<sup>®</sup> Produtos exclusivos da marca e qualidade DU'PONT





Mod.	Mat.	Cod.	Fab.	Mod.	Mat.	Cod.	Fab.	Mod.	Mat.	Cod.	Fab.	Mod.	Mat.	Cod.	Fab.
KR	vari		IN	KR	vari	kr8120	IN	KR	vari	kr8379	IN	KR	vari	kr8480	IN
KR	vari		IN	KR	vari	kr8121	IN	KR	vari	kr8380	IN	KR	vari	kr8482	IN
KR	vari	kr8000	IN	KR	vari	kr8123	IN	KR	vari	kr8381	IN	KR	vari	kr8483	IN
KR	vari	kr8001	IN	KR	vari	kr8124	IN	KR	vari	kr8382	IN	KR	vari	kr8484	IN
KR	vari	kr8002	IN	KR	vari	kr8125	IN	KR	vari	kr8383	IN	KR	vari	kr8485	IN
KR	vari	kr8003	IN	KR	vari	kr8126	IN	KR	vari	kr8384	IN	KR	vari	kr8486	IN
KR	vari	kr8004	IN	KR	vari	kr8127	IN	KR	vari	kr8385	IN	KR	vari	kr8487	IN
KR	vari	kr8005	IN	KR	vari	kr8128	IN	KR	vari	kr8386	IN	KR	vari	kr8488	IN
KR	vari	kr8006	IN	KR	vari	kr8129	IN	KR	vari	kr8387	IN	KR	vari	kr8489	IN
KR	vari	kr8007	IN	KR	vari	kr8135	IN	KR	vari	kr8388	IN	KR	VITO	kr8553	IN
KR	vari	kr8008	IN	KR	vari	kr8136	IN	KR	vari	kr8389	IN	KR	vari	kr8491	IN
KR	vari	kr8009	IN	KR	vari	kr8137	IN	KR	vari	kr8390	IN	KR	vari	kr8492	IN
KR	vari	kr8010	IN	KR	vari	kr8148	IN	KR	vari	kr8392	IN	KR	vari	kr8493	IN
KR	vari	kr8011	IN	KR	vari	kr8149	IN	KR	vari	kr8398	IN	KR	vari	kr8494	IN
KR	vari	kr8012	IN	KR	NITRI	kr8156	IN	KR	vari	kr8405	IN	KR	vari	kr8495	IN
KR	vari	kr8013	IN	KR	vari	kr8159	IN	KR	vari	kr8406	IN	KR	vari	kr8496	IN
KR	vari	kr8014	IN	KR	vari	kr8160	IN	KR	vari	kr8407	IN	KR	vari	kr8497	IN
KR	vari	kr8016	IN	KR	vari	kr8170	IN	KR	vari	kr8409	IN	KR	vari	kr8498	IN
KR	vari	kr8017	IN	KR	vari	kr8173	IN	KR	vari	kr8410	IN	KR	vari	kr8499	IN
KR	vari	kr8018	IN	KR	vari	kr8174	IN	KR	vari	kr8412	IN	KR	vari	kr8500	IN
KR	vari	kr8020	IN	KR	vari	kr8192	IN	KR	vari	kr8413	IN	KR	vari	kr8501	IN
KR	vari	kr8021	IN	KR	vari	kr8198	IN	KR	vari	kr8415	IN	KR	vari	kr8502	IN
KR	vari	kr8022	IN	KR	vari	kr8199	IN	KR	vari	kr8416	IN	KR	vari	kr8503	IN
KR	vari	kr8023	IN	KR	vari	kr8203	IN	KR	vari	kr8420	IN	KR	vari	kr8504	IN
KR	vari	kr8024	IN	KR	vari	kr8209	IN	KR	vari	kr8424	IN	KR	vari	kr8506	IN
KR	vari	kr8025	IN	KR	vari	kr8210	IN	KR	vari	kr8425	IN	KR	vari	kr8507	IN
KR	vari	kr8026	IN	KR	NITRI	kr8213	IN	KR	vari	kr8427	IN	KR	NITRI	kr8509	IN
KR	vari	kr8027	IN	KR	vari	kr8215	IN	KR	vari	kr8428	IN	KR	vari	kr8510	IN
KR	vari	kr8028	IN	KR	vari	kr8221	IN	KR	vari	kr8429	IN	KR	NITRI	kr8511	IN
KR	vari	kr8029	IN	KR	vari	kr8233	IN	KR	PTFE	kr8430	IN	KR	vari	kr8512	IN
KR	vari	kr8030	IN	KR	vari	kr8239	IN	KR	vari	kr8431	IN	KR	vari	kr8513	IN
KR	vari	kr8031	IN	KR	vari	kr8287	IN	KR	vari	kr8432	IN	KR	vari	kr8514	IN
KR	vari	kr8032	IN	KR	vari	kr8289	IN	KR	vari	kr8433	IN	KR	vari	kr8515	IN
KR	vari	kr8033	IN	KR	vari	kr8294	IN	KR	vari	kr8434	IN	KR	vari	kr8516	IN
KR	vari	kr8034	IN	KR	vari	kr8304	IN	KR	vari	kr8435	IN	KR	vari	kr8517	IN
KR	vari	kr8035	IN	KR	vari	kr8310	IN	KR	vari	kr8436	IN	KR	vari	kr8519	IN
KR	vari	kr8036	IN	KR	vari	kr8311	IN	KR	vari	kr8437	IN	KR	vari	kr8521	IN
KR	vari	kr8037	IN	KR	vari	kr8312	IN	KR	NITRI	kr8439	IN	KR	vari	kr8522	IN
KR	vari	kr8038	IN	KR	vari	kr8315	IN	KR	vari	kr8442	IN	KR	vari	kr8523	IN
KR	vari	kr8041	IN	KR	PTFE	kr8319	IN	KR	vari	kr8443	IN	KR	vari	kr8524	IN
KR	vari	kr8042	IN	KR	vari	kr8328	IN	KR	PTFB	kr8444	IN	KR	vari	kr8525	IN
KR	vari	kr8076	IN	KR	VITO	kr8338	IN	KR	vari	kr8445	IN	KR	vari	kr8526	IN
KR	vari	kr8080	IN	KR	vari	kr8344	IN	KR	vari	kr8446	IN	KR	vari	kr8527	IN
KR	vari	kr8091	IN	KR	vari	kr8357	IN	KR	vari	kr8447	IN	KR	vari	kr8528	IN
KR	vari	kr8092	IN	KR	vari	kr8358	IN	KR	vari	kr8448	IN	KR	vari	kr8529	IN
KR	vari	kr8094	IN	KR	vari	kr8359	IN	KR	vari	kr8450	IN	KR	vari	kr8530	IN
KR	vari	kr8096	IN	KR	vari	kr8360	IN	KR	vari	kr8451	IN	KR	vari	kr8531	IN
KR	vari	kr8097	IN	KR	vari	kr8361	IN	KR	vari	kr8453	IN	KR	vari	kr8532	IN
KR	vari	kr8102	IN	KR	vari	kr8365	IN	KR	vari	kr8456	IN	KR	vari	kr8533	IN
KR	vari	kr8103	IN	KR	vari	kr8368	IN	KR	vari	kr8472	IN	KR	vari	kr8534	IN
KR	vari	kr8108	IN	KR	vari	kr8372	IN	KR	vari	kr8474	IN	KR	vari	kr8535	IN
KR	vari	kr8110	IN	KR	vari	kr8373	IN	KR	vari	kr8475	IN	KR	vari	kr8536	IN
KR	vari	kr8116	IN	KR	vari	kr8376	IN	KR	vari	kr8476	IN	KR	vari	kr8539	IN
KR	vari	kr8118	IN	KR	vari	kr8377	IN	KR	vari	kr8477	IN	KR	vari	kr8540	IN
KR	vari	kr8119	IN	KR	vari	kr8378	IN	KR	vari	kr8478	IN	KR	vari	kr8541	IN

Mod.	Mat.	Cod.	Fab.	Mod.	Mat.	Cod.	Fab.	Mod.	Mat.	Cod.	Fab.	Mod.	Mat.	Cod.	Fab.
KR	vari	kr8604	IN	KR	vari	kr8662	IN	KR	vari	kr8734	IN	KR	vari	kr8734	IN
KR	vari	kr8605	IN	KR	vari	kr8663	IN	KR	vari	kr8735	IN	KR	vari	kr8735	IN
KR	vari	kr8606	IN	KR	vari	kr8664	IN	KR	vari	kr8736	IN	KR	vari	kr8736	IN
KR	vari	kr8607	IN	KR	vari	kr8665	IN	KR	vari	kr8737	IN	KR	vari	kr8737	IN
KR	vari	kr8608	IN	KR	vari	kr8666	IN	KR	vari	kr8738	IN	KR	vari	kr8738	IN
KR	VITO	kr8609	IN	KR	vari	kr8667	IN	KR	vari	kr8739	IN	KR	vari	kr8739	IN
KR	VITO	kr8610	IN	KR	vari	kr8668	IN	KR	vari	kr8740	IN	KR	vari	kr8740	IN
KR	vari	kr8611	IN	KR	vari	kr8669	IN	KR	vari	kr8741	IN	KR	vari	kr8741	IN
KR	vari	kr8612	IN	KR	vari	kr8670	IN	KR	vari	kr8742	IN	KR	vari	kr8742	IN
KR	vari	kr8613	IN	KR	vari	kr8681	IN	KR	PTFG	kr8743	IN	KR	PTFG	kr8743	IN
KR	vari	kr8614	IN	KR	vari	kr8682	IN	KR	vari	kr8752	IN	KR	vari	kr8752	IN
KR	vari	kr8615	IN	KR	vari	kr8683	IN	KR	vari	kr8753	IN	KR	vari	kr8753	IN
KR	NITRI	kr8616	IN	KR	vari	kr8684	IN	KR	vari	kr8754	IN	KR	vari	kr8754	IN
KR	SILI	kr8617	IN	KR	vari	kr8685	IN	KR	vari	kr8760	IN	KR	vari	kr8760	IN
KR	vari	kr8618	IN	KR	NITRI	kr8686	IN	KR	vari	kr8761	IN	KR	vari	kr8761	IN
KR	vari	kr8619	IN	KR	VITO	kr8687	IN	KR	NITRI	kr8762	IN	KR	vari	kr8762	IN
KR	vari	kr8620	IN	KR	VITO	kr8688	IN	KR	vari	kr8763	IN	KR	vari	kr8763	IN
KR	vari	kr8621	IN	KR	NITRI	kr8689	IN	KR	vari	kr8764	IN	KR	vari	kr8764	IN
KR	vari	kr8622	IN	KR	vari	kr8690	IN	KR	NITRI	kr8765	IN	KR	vari	kr8765	IN
KR	vari	kr8623	IN	KR	NITRI	kr8691	IN	KR	vari	kr8766	IN	KR	vari	kr8766	IN
KR	vari	kr8624	IN	KR	VITO	kr8692	IN	KR	vari	kr8767	IN	KR	vari	kr8767	IN
KR	vari	kr8625	IN	KR	vari	kr8693	IN	KR	NITRI	kr8768	IN	KR	vari	kr8768	IN
KR	vari	kr8626	IN	KR	vari	kr8694	IN	KR	vari	kr8769	IN	KR	vari	kr8769	IN
KR	vari	kr8627	IN	KR	vari	kr8695	IN	KR	vari	kr8770	IN	KR	vari	kr8770	IN
KR	vari	kr8628	IN	KR	vari	kr8696	IN	KR	vari	kr8771	IN	KR	vari	kr8771	IN
KR	vari	kr8630	IN	KR	vari	kr8697	IN	KR	vari	kr8772	IN	KR	vari	kr8772	IN
KR	NITRI	kr8631	IN	KR	vari	kr8698	IN	KR	vari	kr8773	IN	KR	vari	kr8773	IN
KR	vari	kr8632	IN	KR	vari	kr8699	IN	KR	vari	kr8774	IN	KR	ESPE	kr8829	IN
KR	vari	kr8633	IN	KR	vari	kr8700	IN	KR	vari	kr8775	IN	KR	ESPE	kr8830	IN
KR	vari	kr8634	IN	KR	vari	kr8701	IN	KR	vari	kr8776	IN	KR	ESPE	kr8831	IN
KR	vari	kr8635	IN	KR	vari	kr8702	IN	KR	vari	kr8777	IN	KR	ESPE	kr8832	IN
KR	vari	kr8636	IN	KR	vari	kr8703	IN	KR	vari	kr8777	IN	KR	vari	kr8833	IN
KR	vari	kr8637	IN	KR	vari	kr8704	IN	KR	vari	kr8778	IN	KR	vari	kr8834	IN
KR	vari	kr8638	IN	KR	vari	kr8705	IN	KR	vari	kr8779	IN	KR	vari	kr8835	IN
KR	vari	kr8639	IN	KR	vari	kr8706	IN	KR	vari	kr8780	IN	KR	vari	kr8836	IN
KR	vari	kr8640	IN	KR	vari	kr8707	IN	KR	vari	kr8781	IN	KR	vari	kr8838	IN
KR	vari	kr8641	IN	KR	vari	kr8708	IN	KR	vari	kr8782	IN	KR	vari	kr8839	IN
KR	vari	kr8642	IN	KR	vari	kr8710	IN	KR	vari	kr8783	IN	KR	vari	kr8840	IN
KR	vari	kr8643	IN	KR	vari	kr8711	IN	KR	VITO	kr8784	IN	KR	vari	kr8841	IN
KR	vari	kr8644	IN	KR	vari	kr8712	IN	KR	vari	kr8785	IN	KR	vari	kr8842	IN
KR	vari	kr8645	IN	KR	vari	kr8713	IN	KR	vari	kr8786	IN	KR	vari	kr8843	IN
KR	vari	kr8646	IN	KR	vari	kr8714	IN	KR	vari	kr8787	IN	KR	vari	kr8844	IN
KR	vari	kr8647	IN	KR	vari	kr8715	IN	KR	vari	kr8788	IN	KR	vari	kr8845	IN
KR	vari	kr8649	IN	KR	vari	kr8716	IN	KR	vari	kr8789	IN	KR	vari	kr8846	IN
KR	vari	kr8651	IN	KR	vari	kr8721	IN	KR	vari	kr8790	IN	KR	NY	kr8847	IN
KR	vari	kr8652	IN	KR	vari	kr8722	IN	KR	vari	kr8791	IN	KR	vari	kr8848	IN
KR	vari	kr8653	IN	KR	vari	kr8723	IN	KR	vari	kr8792	IN	KR	vari	kr8849	IN
KR	vari	kr8654	IN	KR	vari	kr8724	IN	KR	vari	kr8793	IN	KR	vari	kr8850	IN
KR	vari	kr8655	IN	KR	vari	kr8725	IN	KR	vari	kr8794	IN	KR	vari	kr8851	IN
KR	vari	kr8656	IN	KR	vari	kr8726	IN	KR	vari	kr8795	IN	KR	vari	kr8852	IN
KR	vari	kr8657	IN	KR	vari	kr8727	IN	KR	vari	kr8796	IN	KR	vari	kr8853	IN
KR	vari	kr8658	IN	KR	vari	kr8728	IN	KR	vari	kr8797	IN	KR	vari	kr8854	IN
KR	vari	kr8659	IN	KR	vari	kr8728	IN	KR	vari	kr8798	IN	KR	vari	kr8855	IN
KR	vari	kr8660	IN	KR	NITRI	kr8729	IN	KR	vari	kr8799	IN	KR	vari	kr8856	IN
KR	vari	kr8661	IN	KR	vari	kr8730	IN	KR	vari	kr8800	IN	KR	vari	kr8857	IN
KR	vari	kr8661	IN	KR	vari	kr8733	IN	KR	vari	kr8801	IN	KR	vari	kr8858	IN





## MECANISMO DE VEDAÇÃO

Fundamentalmente um selo de vedação, ou simplesmente um selo, é um dispositivo destinado a criar vedação em determinada parte de um sistema, com o fim de evitar ou controlar o vazamento de fluidos. Desta forma, consideraremos esse termo como a expressão mais genérica usada para designar peças, órgãos ou outros elementos de vedação, com uma acepção mais ampla que a dada pela Terminologia do Material de Vedação (P-TB-40) da ABNT.

A grande variedade de funções específicas, condições de trabalho, exigências, possibilidades técnicas e econômicas e muitos outros fatores provocaram uma grande diversificação de concepções, arranjos, tipos, modelos e materiais de selos. Não é nosso intuito definir aqui os diversos tipos de selos, pois esse é o objetivo da P-TB-40. Procuraremos apenas apresentar inicialmente um apanhado geral do modo de operação e das aplicações dos tipos principais, que serão estudados em maior detalhe nos capítulos seguintes.

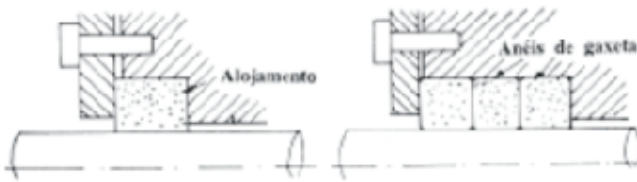

A junta é um dos tipos básicos de selo e destina-se a criar o que se denomina uma vedação estática, isto é, uma vedação entre dois componentes não dotados de movimento um em relação ao outro. Em sua forma mais simples, a junta é uma peça de vedação de material homogêneo, espessura uniforme e configuração semelhante à do espaço que ela veda. Poderá, em alguns casos, também apresentar uma forma mais complexa, construção mista etc.

O vedador é geralmente entendido como uma peça de forma circular (não obrigatoriamente), seções transversais diversas e destinada basicamente à vedação dinâmica mas eventualmente também utilizada para vedação estática. Tensiona-se por meio de mola, por meio da pressão do fluido etc. e o processo de tensionamento é justamente uma das características que o distingue da gaxeta. No Brasil, é muito difundido o uso do termo *retentor* para designar os vedadores. A nosso ver, porém, o termo *retentor* deve ser reservado para designar uma peça destinada a manter outra em

determinada posição e, assim sendo, preferimos evitá-lo. A "Terminologia do Material Automóvel" (P-TB-II) adota esse mesmo critério e a P-TB-40 também preferiu o termo *vedador*.

A gaxeta pode constituir um selo por si mesma ou fazer parte de um selo, como acontece quando usada como material de enchimento em uma caixa de gaxeta ou em um alojamento localizado entre dois componentes deslizantes. Presta-se tanto para vedação estática como dinâmica. Como se verá em maior detalhe em capítulos seguintes (Capítulo 5), a gaxeta é tensionada pela compressão exercida por meio de uma sobreposta, de anéis tensionadores etc.

## Jogos de Vedadores

Um outro método de preencher um alojamento ou caixa de gaxeta consiste em empregar uma série de anéis moldados integralmente ou pré-fabricados. Esse conjunto não deixa de constituir um engaxetamento, mas na realidade seria mais correto designá-lo como jogo de vedadores ou jogo de anéis. Isso se aplica particularmente quando os anéis são de construção especial e, autotensionáveis, não dependendo unicamente de compressão para produzirem vedação. Cada anel age efetivamente como um vedador dinâmico e um grupo de anéis vedadores colocados em um alojamento pode requerer o uso de anéis tensionadores especiais, de modo que o conjunto completo funcione como um conjunto de vedação definido. Não é importante que os anéis sejam inteiriços: eles poderão ser cindidos para facilitar a montagem. O que caracteriza o jogo de vedadores é o agrupamento de diversos anéis de vedação usados em conjunto como uma gaxeta. Os jogos de vedadores são empregados exclusivamente para vedação dinâmica.



## ANÉIS

Os anéis de vedação usados individualmente podem ser denominados vedadores. Nesse caso, o alojamento do vedador reduz-se a uma ranhura de dimensões adequadas e à parte correspondente da contra superfície pertencente ao outro componente.

Esse alojamento distingue-se de uma caixa de gaxeta por não admitir ajustagem para variar a compressão ou o aperto inicial do vedador, que dependerá apenas das dimensões da ranhura e da folga.

A diferença básica entre uma verdadeira gaxeta e um vedador anular de lábio flexível é que a gaxeta só oferece vedação quando comprimida. O vedador de lábio flexível ou tensionado por pressão recebe uma carga prévia de compressão já na montagem, mas a parcela substancial da pressão radial por ele exercida sobre a superfície em que se apóia é fornecida pela pressão do fluido transmitida hidrostáticamente através das partes flexíveis do próprio vedador. Qualquer ajustamento adicional da compressão será empregado exclusivamente para compensar o desgaste.

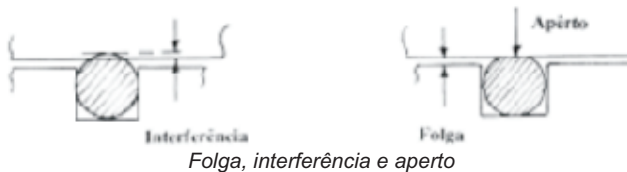

Folga, interferência e aperto

Um vedador (ou gaxeta) de compressão requer o uso de material e seção facilmente compressíveis. Deve possuir baixa rigidez de forma, geralmente relacionada com alta compressibilidade, de modo que a face do vedador se amolde intimamente à forma ou ao estado da superfície contra a qual é comprimida, pois essa superfície possui normalmente alta rigidez de forma. Para ter-se vedação, é necessário então aplicar-se compressão ou carga prévia até que a pressão exercida sobre a face do vedador ultrapasse a pressão a ser vedada. Não havendo vias localizadas de vazamento, a vedação se manterá enquanto perdurar esse excesso de pressão. A única precaução necessária consiste em assegurar-se de que a pressão externa não seja tão elevada, nem o vão da folga tão grande que o material compressível do vedador ou da gaxeta se extrude através desse vão.



Compressão do vedador e pressão vedada

## VEDADORES FLEXÍVEIS

Um vedador flexível requer o uso de um material incompressível (ou quase); obtém-se sua flexibilidade por meio de uma forma de baixa rigidez. Ao ser montado, ele se deforma ligeiramente e essa deformação provoca uma pressão de carga prévia sobre o lábio de vedação. Quando submetido à pressão do fluido ( $P$ ) essa pressão transmitida pelo lábio soma-se à pressão da carga prévia ( $p$ ) e dessa forma a pressão resultante ( $P + p$ ) é sempre superior à pressão do fluido, assegurando-se assim uma vedação positiva.

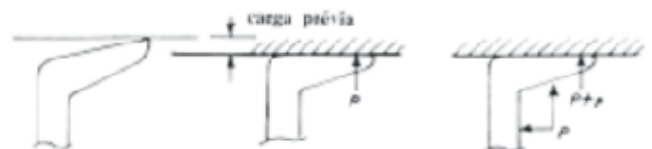

Compressão do lábio de vedação

Para que isso aconteça, contudo, é necessário que o lábio se amolde suficientemente bem à superfície de modo que não haja vias localizadas de vazamento; e também que se mantenha a vedação na parte principal da seção do vedador em sua ranhura.

## SELOS DE COMPRESSÃO

Os selos de compressão constituem a escolha óbvia para aplicações de vedação estática, já que não há necessidade de levar em consideração os efeitos do atrito ou de desgaste abrasivo e dessa forma a compressão pode ser aumentada na medida do necessário até que a pressão de compressão seja maior que a pressão a ser vedada. No caso de juntas, isso exige que as contra-superfícies tenham acabamento fino e sejam planas, de modo que se possa aplicar a compressão inicialmente até que não haja folga entre as faces das peças e as faces correspondentes das juntas e então continuar a compressão para comprimir o próprio material da junta e atingir-se a pressão de vedação requerida. A falta de planidade ou irregularidade no aperto final pode resultar em variações da pressão de compressão na junta, caso em que a pressão efetiva na junta será apenas a do mais baixo valor local da compressão da junta.

## VEDADORES TENSIONADOS POR PRESSÃO

Os vedadores tensionados por pressão oferecem um método alternativo de vedação estática quando é impraticável ou indesejável o uso de juntas convencionais ou outros selos de compressão, e geralmente possibilitam

soluções mais simples para vedação em temperaturas de serviço situadas dentro das faixas de temperaturas de trabalho dos materiais elastoméricos. Essa forma de aplicação requer o uso de vedadores flexíveis, sendo que normalmente a flexibilidade necessária é obtida de modo mais favorável por uma escolha criteriosa do material do que pelo emprêgo de uma seção labiada. O tensionamento resulta então da deformação de toda a seção, provocada pela pressão do fluido, como ocorre com os anéis O. O fator crítico nesses casos é geralmente a extrusão da seção flexível no sentido do vão da folga, isto é, do espaço existente entre as duas contrapartes. Quanto menor esse vão, maior a pressão que o vedador pode suportar sem sofrer extrusão. Fechando-se totalmente o vão, torna-se possível vedar pressões estáticas muito elevadas com simples anéis de vedação.

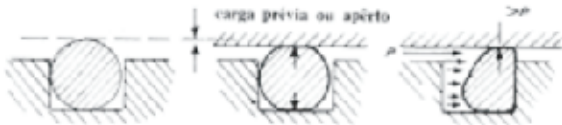

Nesses casos, os anéis podem funcionar como puros vedadores de compressão submetidos a uma pressão produzida inteiramente pelo apêto e superior à pressão vedada. Nessas condições, o vedador ficará quase com certeza deformado permanentemente e precisará ser substituído se a junção for aberta e refeita.

## VEDADORES DINÂMICOS

Os vedadores dinâmicos precisam atender a um compromisso satisfatório entre a vedação, de um lado, atrito e desgaste, de outro lado. Com vedadores de compressão, é inevitável uma elevada carga prévia e conseqüentemente um grande atrito. Isso pode ser remediado até certo ponto pela escolha do material da gaxeta ou do vedador e pode também ser regulado, apertando-se a sobreposta (no caso de uma gaxeta) a um valor mínimo de compressão compatível com um grau de vedação aceitável, admitindo-se ao mesmo tempo um certo vazamento. Será necessária então uma reajustagem periódica, para compensar o desgaste que possa ocorrer na face da gaxeta. Isso é uma exigência normal para a maioria dos tipos de caixa de gaxeta.

Com vedadores de compressão, o atrito é inevitavelmente elevado, independentemente da pressão reinante. Assim, ajustando-se uma caixa de gaxeta para vedar uma determinada pressão elevada, a compressão (e portanto o atrito) será maior que o necessário quando se trabalha em pressões mais baixas. O atrito estático e conseqüentemente a força de irrupção

será também mais elevada que o atrito de marcha, se bem que essa diferença possa ser desprezível no caso de gaxetas revestidas ou impregnadas de PTFE. A outra desvantagem principal de um vedador de compressão para aplicações dinâmicas é a de ser geralmente muito mais volumoso que um vedador tensionado por pressão.

Há, contudo, diversas aplicações em que se prefere um determinado tipo. Assim, para movimentos rotativos, principalmente em serviços pesados, a caixa de gaxeta é geralmente mais durável e pode representar a única possibilidade de empregar-se um material capaz de trabalhar nas altas temperaturas e severas condições de serviço reinantes. Vedadores ou jogos de vedadores labiais flexíveis (tensionados por pressão), por outro lado, podem geralmente apresentar desempenho superior em serviços alternativos, mesmo sob condições severas (dentro da faixa de temperaturas de serviço dos materiais empregados), com atrito e desgaste sensivelmente menores. Todos os vedadores flexíveis, contudo, podem estar sujeitos a limitações bem definidas em relação à pressão que podem suportar sem sofrer extrusão ou deformação excessiva e, em vista da imensa variedade de modelos disponíveis, requerem estudo individual para aplicação e instalação.

## LUBRIFICAÇÃO DO VEDADORES

Em quase todos os tipos de vedadores dinâmicos de compressão ou tensionados por pressão a lubrificação das faces do vedador é um fator importante que governa o desempenho e a vida do vedador. Há uma possível exceção quando a superfície deslizante é de PTFE, que possui um coeficiente de atrito extremamente baixo com a maioria das outras superfícies e pode deslizar sem lubrificação com desgaste desprezível. Em aplicações "úmidas" o fluido que se veda pode fornecer lubrificação efetiva. Para vedar gases secos, soluções aquosas ou vapor, em que o próprio fluido não seja um lubrificante, pode ser necessário prover a face do vedador de uma fonte de lubrificação ou impregnar o material de vedação com um lubrificante. Isso pode até exigir um modelo especial de vedador ou pode reduzir substancialmente a escolha do tipo de vedador ou gaxeta.

Quando se veda um líquido e esse líquido é também um lubrificante, pode-se prever que, uma vez assentada, a superfície do vedador ficará separada de contato íntimo com a superfície da peça por uma película muito fina de líquido, possivelmente mais fina que uma camada-limite normal. Sendo mantida essa película, o vedador trabalhará em condições de lubrificação, com atrito e desgaste mínimos. Tanto o atrito como o desgaste,



contudo, aumentarão pela presença de quaisquer partículas que atravessem a película superficial hidrodinâmica, tais como picos de rugosidade da superfície metálica ou partículas abrasivas aprisionadas sob a face do vedador.

No caso de vedadores para movimentos alternativos, a película hidrodinâmica se conservará no lado "seco" do vedador. Assim, por exemplo, uma haste, ao emergir, carregará consigo uma película de óleo, que não é necessariamente uma indicação de vazamento, mas antes um sinal positivo de que a face do vedador está recebendo lubrificação. Essa película será recolhida novamente através do vedador no curso emergente da haste, a menos que o vedador possua, pronunciada ação de raspagem, como seria o caso quando se usa um vedador de compressão.

## VAZAMENTOS

O vazamento real, nesses casos, é representado pela quantidade de óleo (ou do líquido vedado) que cai realmente da haste ou que se acumula progressivamente no lado "seco" do vedador. No caso de vedadores de compressão, pode ser necessário ter-se um vazamento positivo contínuo para assegurar lubrificação permanente adequada da face do vedador, a menos que eles sejam autolubrificadas, podendo então o vazamento ser eliminado por um aumento da compressão. No caso de vedadores flexíveis, o vazamento real corresponde à diferença entre a película emergente e a película refluyente, que fica efetivamente depositada e pode ser desprezível. Um vazamento excessivo pode ser causado por um vedador que esteja vazando ou por uma raspagem excessiva no curso de retorno produzida, por exemplo, por um anel raspador muito apertado. De fato, um anel raspador associado a um anel de vedação principal pode agir como uma bomba, o raspador removendo nos cursos emergentes o grosso da película emergente normalmente depositada sobre a haste, se bem que para isso a ação de raspagem precise ser muito forte.

As principais conclusões de interesse prático que tiramos do parágrafo anterior são as seguintes: a) existe uma diferença entre vazamento aparente e vazamento real, principalmente no caso de vedadores labiais; b) a presença de óleo sobre a superfície no lado "seco" de um vedador é normal e até mesmo desejável (indica lubrificação adequada); c) o fato de um vedador manter-se completamente seco em operação pode indicar falta de lubrificação e a probabilidade de desgaste ou falha prematura. A presença de uma película de óleo em uma

haste emergente como em que pode tornar necessário o uso de raspadores em ambientes contaminados de poeira ou sujeira. O raspador removerá no curso emergente as partículas que aderirem ao óleo, evitando que elas retomem ao vedador com a película refluyente no curso emergente.

## ATRITO DOS VEDADORES

Além de representar perda de potência e desgaste, o atrito na interface vedador/superfície resulta em aquecimento, que pode ocasionar a degradação do material do vedador (principalmente elastômeros) e da película hidrodinâmica do líquido. A degradação dessa película pode provocar a formação de produtos abrasivos, o que contribuirá para aumentar o atrito e o desgaste.

É difícil analisar em termos gerais o desempenho do vedador sob esse aspecto, porque isso envolve muitos fatores empíricos ligados especificamente ao projeto do vedador. Entretanto, como um ponto de partida, sabemos que o atrito é função da pressão efetiva de contato e que o coeficiente de atrito varia com o material, o acabamento superficial, a velocidade, o tempo etc.

Onde não há entramento (emperramento), como por exemplo em vedadores rotativos ou vedadores alternativos com folga mínima, a força de atrito é aproximadamente proporcional à pressão efetiva de contato.

$F_a = \text{força de atrito} = \mu P_e \cdot ab$  - onde

$\mu = \text{coeficiente de atrito}$ .

$P_e = \text{pressão efetiva de contato na face do vedador, em kgf/mm}^2$   
 $a = \text{largura de contato da face do vedador, em mm}$   
 $b = \text{comprimento de contato da face do vedador, em mm}$

(=  $1T d$  no caso de vedadores circulares, sendo  $d$  o diâmetro de contato do vedador).

No caso de um verdadeiro vedador de compressão, a seção é substancialmente rígida, quando comprimida, não há probabilidade de entramento e normalmente o atrito é amplamente independente da pressão interna. A pressão efetiva de contato ( $P_e$ ) pode portanto ser tomada como a pressão real de compressão, embora seja difícil ou impossível de determinar. O coeficiente de atrito ( $\mu$ ) também pode ser desconhecido, e variável, mas pode ser possível determiná-lo com uma razoável precisão, como será discutido mais tarde. É difícil, portanto, obter soluções específicas, a não ser por métodos empíricos ou pelo uso de dados comparativos. Assim, a fórmula pode ser usada diretamente para investigar possíveis diferenças de desempenho e atrito em vedadores de compressão de mesmo tipo e material, mas de tamanhos diferentes.

No caso de vedadores flexíveis tensionados por pressão, a pressão efetiva é igual à soma da pressão de carga prévia e da pressão do fluido. Quanto maior a pressão do fluido, menor influência da carga prévia, que poderá inclusive ser ignorada em muitos casos na estimativa do atrito em serviços de alta pressão. Se necessário para o cálculo em serviços de baixa pressão, o valor da carga prévia determina-se preferivelmente por medida direta.

## MATERIAIS PARA VEDADORES

Os elastômeros constituem o principal grupo de materiais usados em todas as formas de vedadores moldados, quer como peças moldadas homogêneas, anéis inteiriços de diferentes seções, quer como impregnantes de tecidos utilizados em anéis reforçados ou de alta resistência etc. Essas peças moldadas homogêneas também podem ser denominadas vedadores de borracha.

Os elastômeros podem ser definidos como materiais semelhantes à borracha, expressão que abrange tanto as borrachas naturais como as sintéticas. Essa definição é um pouco vaga e apenas indica que o material tem a capacidade de distender-se e recuperar-se quando descarregado, ou seja, que o material é elástico, uma propriedade geral também observada em alguns materiais que não são verdadeiros elastômeros. Uma definição mais rigorosa especifica as propriedades elásticas necessárias para que um material se classifique como elastômero, como por exemplo a capacidade de ser distendido pelo menos a 100% e, quando aliviado da carga, voltar ao comprimento original com aproximação de 10% dentro de um tempo razoavelmente curto.

Essa definição exclui alguns materiais que podem ser e realmente são usados em vedadores, como os couros e certas fibras vegetais e minerais e certos materiais sintéticos bem mais rígidos. Um exemplo típico do último grupo é o politetrafluoretileno (PTFE), que possui baixo alongamento mas apresenta muitas características favoráveis. Esses materiais podem ser classificados como plastômeros. Existem também materiais sintéticos cujas moléculas são grandemente modificadas com a finalidade de imprimir certas características, como por exemplo conferir propriedades elastoméricas a um plastômero. Os materiais resultantes são extremamente caros e de aplicação bastante limitada, se bem que em alguns casos possam satisfazer determinadas exigências que estejam fora das possibilidades de outros materiais disponíveis. Devido a sua raridade e custo, eles

são às vezes denominados “materiais exóticos”.

Um outro ponto importante a lembrar quando se estudam certos materiais é que muitas vezes um nome ou uma designação tem uma aplicação genérica. Em outras palavras, muitas vezes uma grande variedade de compostos estão agrupados sob a mesma designação e todos eles possuem determinadas propriedades gerais, mas as propriedades específicas diferirão de um para outro, de acordo com o teor dos componentes. Isso se aplica principalmente aos materiais sintéticos, para os quais são possíveis amplas variações em polimerização e copolimerização. A composição também pode introduzir outros ingredientes destinados a enquadrar ainda mais as propriedades na direção da finalidade visada. Isso se refletirá nas propriedades mecânicas, físicas e químicas do material resultante e afetará também o processamento e a aptidão do material para sofrer o processamento.

As infinitas variantes possíveis ao longo dessas linhas tornam impossível descrever os elastômeros de forma completa. Além disso, continuam a aparecer materiais novos e os materiais existentes continuam a ser aperfeiçoados. Para fins práticos, contudo, na grande maioria dos casos a escolha do material recai logicamente sobre um determinado tipo de elastômero e, dentro desse tipo, sobre uma faixa bem restrita de propriedades. É útil e conveniente discutir os materiais por tipos distribuídos em diferentes tópicos. No caso de materiais elastoméricos, o termo “tipo” refere-se especificamente ao elastômero básico usado.

## NATURAL

A borracha natural situa-se entre os mais antigos dos verdadeiros materiais de vedação e ainda hoje é um dos elastômeros mais fortes e mais resistentes ao desgaste (sob esses aspectos, foi suplantada apenas pelas borrachas de poliuretano). Seu uso em vedadores de fluidos, contudo, é um pouco limitado, porque a borracha natural tem pouca resistência aos óleos minerais básicos. Entretanto, os vedadores de borracha natural são excelentes para uso com líquidos à base de óleo de mamona e são amplamente empregados em sistemas onde se usam aqueles líquidos (por exemplo, sistemas de freios hidráulicos de veículos automotivos e, em escala muito menor, em sistemas hidráulicos de aeronaves). As características de baixa temperatura, geralmente excelentes, da borracha natural, constituíam originalmente um fator favorável ao uso de líquidos hidráulicos à base de óleo de mamona em sistemas que operavam em baixa temperatura, onde podiam ser empregados vedadores de borracha natural, devendo-se

notar, contudo, que atualmente alguns elastômeros sintéticos apresentam desempenho comparável. O preço da borracha natural também é favorável, sendo sensivelmente inferior ao de todas as borrachas sintéticas, com exceção da butílica e da Buna.

As borrachas naturais podem ser modificadas pela composição de modo a satisfazerem uma grande variedade de condições, apresentando inclusive alta resiliência e resistência mecânica, e geralmente é interessante estudar a possibilidade de sua adoção em aplicações onde não se utilizam óleos minerais. Sua flexibilidade mantém-se até aproximadamente -55°C e só borrachas silicônicas consideravelmente mais caras e menos resistentes são comparáveis sob esse aspecto.

## **BUNA S**

Nos países de língua inglesa, essa borracha era conhecida inicialmente como GRS (Government Rubber Styrene) e posteriormente como SBR (Styrene-Butadiene Rubber - borracha estireno-butadiênica). Foi produzida durante a Segunda Guerra Mundial especificamente como um substituto da borracha natural, embora com propriedades geralmente inferiores, se bem que a resistência à abrasão seja comparável. Pode ser considerada como uma alternativa direta da borracha natural, para uso, por exemplo, em peças que tenham contato com líquidos hidráulicos à base de óleo de mamona, sendo essa possivelmente sua única aplicação em vedadores.

## **BUTADIENO**

A borracha polibutadiênica ou butadiênica, geralmente conhecida como BR, é também um substituto para a borracha natural, apresentando propriedades semelhantes, embora geralmente inferiores. Seu desempenho em baixas temperaturas é um pouco melhor que o da SBR, mas sua aplicação como material de vedação é muito limitada.

## **BUTÍLICA**

As borrachas butílicas são um copolímero de isobutileno e isopreno, formando um grupo de elastômeros extremamente resistentes à água (mais que o cloropreno e as borrachas nitrílicas) e a alguns outros líquidos. Uma outra característica favorável é sua grande impermeabilidade aos gases, o que as torna interessantes para vedadores de sistemas de vácuo.

As butílicas são também resistentes aos óleos vegetais, mas não são adequadas para uso com óleos

minerais básicos e solventes aromáticos. Até relativamente pouco tempo atrás, elas constituíam a primeira escolha em materiais para vedação de líquidos hidráulicos do tipo fosfato orgânico, sendo que agora, para essa aplicação, elas já foram igualadas e mesmo largamente superadas pelas borrachas etileno-propilênicas.

## **NEOPRENE**

É uma das melhores borrachas sintéticas para fins gerais, se bem que atualmente seu emprego em vedadores esteja um pouco limitado. Sua principal vantagem está na excelente resistência ao envelhecimento pelas intempéries. Também supera a borracha natural no desempenho em altas temperaturas, mas tem a tendência de endurecer ou enrijecer em baixas temperaturas e poderá inclusive cristalizar em baixas temperaturas se estiver sob tensão. Sua resistência aos óleos é de moderada à boa. É excelente para peças de vedação que estejam em contato com refrigerantes e também pode ser usado com ácidos suaves. Fora isso, não é usado em grande escala como material de vedação, a não ser para raspadores.

## **POLIETILENO CLOROSSULFONADO**

Também conhecido como CSM (chlorosulphonated monomer - monômero clorossulfonado). As propriedades mecânicas desse elastômero tendem a ser baixas para fins de vedação. Entretanto, o material tem boa resistência aos ácidos e ao calor e pode ser usado em aplicações que requeiram essas propriedades. Também é completamente resistente ao ozônio.

## **ETILENO PROPILENO**

As borrachas etileno-propilênicas ou EP (também conhecidas como borrachas EPM nos Estados Unidos) possuem boas características térmicas e excelente resistência a muitas soluções químicas, tais como solventes aromáticos, aos óleos minerais e aos derivados de petróleo, de modo que seu emprego como material de vedação é um pouco restrito. Nesse campo, é usado principalmente para vedadores de sistemas hidráulicos que utilizam líquidos não inflamáveis à base de fosfato orgânico, como Skydrol, por exemplo; e também líquidos silicônicos, como Silcodyne H. As borrachas EP são também excelentes para serviços de vapor e água quente (dentro dos limites de temperatura de serviço do material).

Um outro copolímero de etileno-propileno, conhecido como EPDM, oferece melhor desempenho em certos serviços.



## FLUORCARBONETO

São dos mais caros elastômeros baseados na copolimerização de fluoreto de vinilideno e hexafluorpropileno, oferecendo uma série de borrachas com grande resistência química e temperatura máxima em serviço contínuo de 200 à 250°C. Também são especialmente adequados para vedadores de serviços de vácuo, embora seu desempenho em baixas temperaturas não seja bom, comparando-se sob esse aspecto apenas às borrachas de alta nitrila.

As borrachas de fluorcarboneto podem ser usadas vantajosamente em serviços que exijam resistência ao calor, aos ácidos, aos óleos minerais, aos hidrocarbonetos halogenados, aos aromáticos etc. ou onde se justifique seu preço.

## NITRÍLICA

As borrachas nitrílicas constituem o grupo mais importante de elastômeros para usos gerais e seu emprego em vedadores é provavelmente superior ao de todos os outros elastômeros juntos. Quimicamente, as borrachas nitrílicas são um copolímero de butadieno e acrilonitrila, variando o teor de acrilonitrila tipicamente entre 18% a 48% aproximadamente, recebendo correspondentemente as designações de borrachas de baixa, média ou alta nitrila. Aumentando-se o teor de nitrila, aumenta sua resistência aos óleos minerais e aos hidrocarbonetos e diminui sua flexibilidade em baixas temperaturas. Para se obter bom desempenho das borrachas nitrílicas em baixas temperaturas, é geralmente necessário sacrificar em parte sua resistência aos óleos combustíveis e lubrificantes em altas temperaturas.

As borrachas nitrílicas possuem boas propriedades físicas e são superiores à maioria das outras borrachas no que diz respeito à resistência à deformação a frio, ao rasgamento e à abrasão. Elas não são especialmente resistentes ao ozônio, às intempéries e à luz solar, mas sua resistência a esses agentes pode ser melhorada pela composição. Em vista de sua suscetibilidade ao ozônio, os vedadores de borracha nitrílica não devem ser estocados nas proximidades de qualquer possível fonte de ozônio por exemplo, um motor ou outro equipamento elétrico, a luz solar direta etc.

As borrachas nitrílicas são especialmente adequadas para vedação de óleos minerais e outros derivados de petróleo, água, graxas e óleos silicônicos e líquidos à base de glicóis resistentes ao fogo. Geralmente não são adequadas para uso em contato com hidrocarbonetos

halogenados, nitrocarbonetos, fluidos à base de fosfatos orgânicos, cetonas ou ácidos fortes e alguns líquidos para freios hidráulicos de veículos automotivos.

## POLIACRÍLICA

As borrachas poliacrílicas (ACM) são produtos resultantes da polimerização de ésteres acrílicos ácidos e formam um grupo de características intermediárias entre as borrachas de fluorcarbonetos e as nitrílicas. Uma de suas características mais importantes sob o ponto de vista de vedação é sua excelente resistência aos óleos minerais, aos óleos hipóides e às graxas até temperaturas de 175°C. Uma excelente resistência ao envelhecimento e ao fendimento sob flexão também torna essas borrachas indicadas para uso em vedadores para eixos rotativos. Suas características de baixa temperatura não são muito boas; sua resistência mecânica e sua resistência à água são geralmente baixas.

## BORRACHAS DE POLISSULFETO

Essa borracha destaca-se por sua excelente resistência aos combustíveis e solventes, ao oxigênio, ao ozônio e ao envelhecimento. Suas propriedades mecânicas e de resistência ao calor, entretanto, são baixas, de modo que esse elastômero não é muito usado como material de vedação, a não ser quando não se consegue encontrar um substituto capaz de oferecer suficiente resistência química. Seu odor traz objeções ao seu manuseio para processamento.

## URETANO

Essas borrachas constituem um dos mais recentes desenvolvimentos no campo dos elastômeros, apresentando excepcional resistência mecânica, ao rasgamento e à abrasão (superior à de todas as outras borrachas) e retendo excelente flexibilidade em baixas temperaturas. Possuem boa resistência aos derivados de petróleo, aos hidrocarbonetos, ao ozônio e às intempéries. Geralmente apresentam desempenho insatisfatório em contato com soluções aquosas de natureza ácida ou alcalina, hidrocarbonetos clorados, cetonas, água quente, vapor ou glicóis. Suas características de compressão e deformação permanente tendem a degradar-se rapidamente com aumento de temperatura.

As borrachas de poliuretano são, portanto, mais interessantes pela resistência mecânica do que pela resistência química ou térmica.

Elas podem ser usadas vantajosamente, quando compatíveis, em meios abrasivos e são especialmente indicadas para uso em raspadores.



## SILICONE

Essas borrachas formam um grupo de elastômeros muito importante, e retem as propriedades mecânicas em uma faixa de temperatura muito grande. Sua flexibilidade mantém-se até temperaturas inferiores a  $-70^{\circ}\text{C}$ , podendo-se por outro lado usar esses materiais em temperaturas máximas de serviço contínuo de pelo menos  $230^{\circ}\text{C}$ .

Basicamente, as borrachas silicônicas possuem baixa resistência mecânica, ao rasgamento e à abrasão, mas a resistência mecânica pode ser aumentada por meio de composição especial. Geralmente apresentam boa resistência aos álcalis, aos ácidos fracos e ao ozônio; e apenas moderada aos óleos. Também a resistência química pode ser aumentada pela composição para melhorar a resistência aos óleos lubrificantes e combustíveis, por exemplo. De um modo geral, contudo, não se recomenda o uso de borrachas silicônicas com hidrocarbonetos como querosene e parafina, óleos minerais leves ou vapor sob pressões acima de  $3,5 \text{ kgf/cm}^2$ , pois poderiam resultar em inchamento e amolecimento consideráveis do elastômero.

A principal vantagem desses elastômeros está em sua capacidade de reter flexibilidade em temperaturas muito baixas e também de suportar permanência contínua em altas temperaturas sem endurecer, o que os torna adequados para vedadores tanto para altas como para baixas temperaturas, abrangendo uma faixa mais larga que a coberta pelos outros elastômeros. Por esse motivo, eles podem também ser empregados em vedadores rotativos, em aplicações onde a temperatura de trabalho esteja acima do máximo admissível para os elastômeros convencionais por causa do calor desenvolvido pelo atrito, caso em que uma borracha silicônica pode oferecer uma solução. O custo das borrachas silicônicas, no entanto, é substancialmente mais elevado que o da maioria dos outros elastômeros.

As borrachas fluorsilicônicas foram desenvolvidas mais recentemente e são mais caras ainda. Suas características de trabalho são geralmente semelhantes às das borrachas silicônicas comuns, porém com uma faixa de temperaturas de trabalho mais restrita. Sua principal vantagem está em poderem possuir uma resistência aos óleos comparável ou bem próxima à das borrachas nitrílicas. Desta forma, elas podem ser usadas em aplicações onde as temperaturas ultrapassem os limites das temperaturas de serviço das borrachas nitrílicas e onde as borrachas silicônicas comuns não sejam compatíveis com o fluido vedado.

## PLASTÔMEROS

Os plastômeros são geralmente materiais semi-rígidos e normalmente não são empregados como tais na fabricação de vedadores. A única exceção é o PTFE, um plastômero à base de fluorcarboneto dotado de propriedades muito especiais destacando-se uma quase total insensibilidade ao ataque químico, uma grande faixa de temperaturas de serviço e um coeficiente de atrito sobre o aço da mesma ordem de gelo deslizando sobre gelo. Sua resistência mecânica, contudo, é baixa, quando não se usam enchimentos ou reforços.

Essas propriedades aproximam-se do ideal para muitos serviços de vedação, uma vez superadas as limitações básicas. Assim, o PTFE pode ser usado como um impregnante de baixo atrito em seções de gaxetas ou vedadores pré-fabricados, oferecendo as próprias seções a necessária resistência mecânica. Em outras aplicações, pode ser o único material, ou definitivamente o mais adequado, capaz de resistir ao fluido manuseado. Nesse caso, pode-se moldar com aquele material um anel de vedação de tipo padrão, possivelmente com alguma modificação de desenho para compensar as baixas propriedades elásticas; ou pode-se também modificar ligeiramente o material básico para lhe conferir um grau aceitável de elasticidade. Essa última modalidade tem possibilidades muito limitadas e a máxima distensão que se pode esperar de anéis moldados de PTFE é da ordem de 10%. Isso pode provocar problemas na montagem, por exemplo quando é necessário distender suficientemente os anéis para colocá-los em suas ranhuras. A recuperação após uma distensão será lenta, de modo que é necessário deixar em repouso os anéis montados por longo tempo, até recuperarem seu tamanho original, se bem que o processo de recuperação possa ser acelerado por um suave aquecimento.

A maior aplicação de PTFE em vedadores moldados encontra-se nos anéis O, que são produzidos em uma grande variedade de tamanhos padronizados. Normalmente se compõe o PTFE de maneira a conferir-lhe uma capacidade de distensão não superior a 10% do diâmetro interno original que requereria o uso de conjuntos cindidos para os tamanhos de pequeno diâmetro.

Os anéis O de PTFE podem normalmente ser montados em ranhuras com as mesmas dimensões que as recomendadas para anéis O elastoméricos, embora em certas aplicações seja desejável, ou necessário, reduzir o aperto, isto é, aumentar ligeiramente a profundidade da ranhura. Seu custo é superior ao dos anéis O elastoméricos, mas quando se prevê uma certa diversidade de aplicações eles apresentam a vantagem de uma compatibilidade geral, evitando a necessidade de



manter estoques de anéis de diferentes elastômeros. No caso mais geral, só se escolhe um anel O de PTFE por motivo de compatibilidade quando, por exemplo, nenhum elastômero oferece a resistência química necessária; ou quando se deseja um anel O com características de atrito extremamente baixo ou ausência de estrição.

A aplicação de PTFE aos anéis moldados com outras seções é muito mais limitada ainda, tanto quanto à extensão como quanto às formas de moldagem prática.

Uma outra aplicação muito útil do PTFE aos vedadores, contudo, vamos encontrar nos anéis de construção mista, em que se pode empregar uma seção de PTFE usinada ou moldada, destinada a oferecer uma superfície deslizante de baixo atrito, apoiada em uma seção elastomérica; ou como anéis de apoio para anéis O etc.

No caso de anéis de apoio, mais uma vez a baixa capacidade de distensão do PTFE constitui um problema e comumente os anéis deste material são cindidos ou em espiral, para facilitar a montagem. Se de um lado isso tem a desvantagem de apresentar uma superfície interrompida em que se apóia o anel O sob pressão, de outro lado isso é largamente compensado pelas vantagens oferecidas.

Dois plastômeros semelhantes ao PTFE são o PTFCE (poli-tri-fluorcloroetileno) e FEP (etileno-propileno fluorado). O PTFCE tem propriedades gerais semelhantes às do PTFE, mas sua resistência química não é tão alta e sua faixa de temperaturas de trabalho é um pouco mais restrita. Sua principal vantagem está em prestar-se melhor à moldagem que o PTFE e poder ser moldado por injeção, se necessário, em formas mais complicadas. O FEP também pode ser moldado por injeção. Suas propriedades gerais também são semelhante às do PTFE, mas sua temperatura máxima de serviço reduz-se ao nível de aproximadamente 200°C.

Outros materiais que podem ser usados para anéis de apoio incluem o couro, os tecidos recobertos ou impregnados de borracha, os produtos laminares termoestáveis como o tufnol e o náilon. Nenhum desses materiais, com exceção do couro e dos tecidos recobertos ou impregnados de borracha, é usado normalmente em vedadores com a função de vedação.

## COURO

O couro é o mais antigo dos materiais utilizados em vedadores, tendo sido empregado para esse fim desde os primeiros dias da engenharia mecânica e dos fluidos. O fato de ser o couro ainda empregado em vedadores, apesar do advento de tantos materiais modernos, deve-se não só às boas características do material como

também aos modernos métodos de processamento e tratamento, que propiciaram uma considerável melhora de suas propriedades mecânicas.

O couro é formado por fibras entrelaçadas de alta resistência, que lhe conferem as características intrínsecas de flexibilidade, resistência mecânica e resistência à abrasão. É, por outro lado, um material relativamente brando, de maneira que exerce pequena ação abrasiva sobre os materiais com os quais está em contato deslizante. Também tem limitações, principalmente a pequena durabilidade (que limita as formas de seções de vedadores possíveis em couro) e a falta de rigidez e extensibilidade.

Para fins de vedação, as duas principais vantagens do couro são o modo como pode vedar, deslizando sobre superfícies relativamente ásperas, e sua capacidade de absorver e reter lubrificantes. A primeira vantagem assegura muitas vezes a possibilidade de se usar um vedador de couro em superfícies que seriam excessivamente ásperas para permitir uma vedação eficiente por meio de um elastômero (ou provocariam atrito e desgaste excessivos com vedadores elastoméricos). Frequentemente se pode usar também um vedador de couro como uma peça de reposição em eixos ou furos gastos, representando uma alternativa para o condicionamento do eixo ou do furo, que seria necessário para se usar satisfatoriamente um novo vedador elastomérico. Sua capacidade de reter lubrificantes significa que um vedador de couro pode oferecer melhor solução que um vedador elastomérico quando a lubrificação é restrita ou quando o vedador continua a trabalhar apenas com a lubrificação original.

A maioria dos modernos couros industriais é do tipo cromo curtido com uma tensão de ruptura acima de 400 kgf/cm<sup>2</sup>. Sua temperatura máxima de serviço pode ser da ordem de 150 a 160°C, dependendo do tratamento e, até certo ponto, do ambiente. O desempenho mecânico pode ser ainda melhorado ou modificado, revestindo-se ou impregnando-se o material. Assim, pode-se usar impregnação de borracha silicônica para manter a flexibilidade em temperaturas muito baixas (-60 a -90°C), se bem que isso aumente consideravelmente o custo do material. A introdução de triglicéridos e estearina aumenta a resistência à água e produz um couro gorduroso e flexível, adequado para vedadores e gaxetas, se bem que nesse caso o impregnante seja solúvel em óleo. A impregnação com cêra de parafina produz um couro mais rígido, excepcionalmente resistente à água e usado para vedadores e gaxetas em serviços de água. O tratamento com uma emulsão de acrílico produz uma superfície granular forte e muito flexível, resistente ao óleo mas

permeável à água. A impregnação de poliuretano confere boa resistência aos óleos e à água, associada a uma boa flexibilidade. Podem-se, portanto, modificar as características do couro (ainda que não na mesma escala dos elastômeros) e desta forma podemos dispor de uma ampla faixa de escolha. A variável principal - a qualidade do couro original é uma questão de seleção e controle da qualidade.

A limitada moldabilidade do couro geralmente restringe sua aplicação aos copos, às seções de flange e chapéu, às gaxetas U e V. As seções flangeadas são amplamente usadas em vedadores de óleo.

Sua compatibilidade é bem mais limitada que a apresentada pelo conjunto dos elastômeros. Em geral os vedadores de couro são adequados para uso com todos os óleos mas tem pouca compatibilidade com soluções aquosas e não são recomendados para uso com ácidos, álcalis, gases e produtos químicos orgânicos.





## Tabela de tolerância à componentes químicos

PROPRIEDADE		NITRÍLICA	*	*	*				*		
A Denominação Química	NATURAL	Nitrílica(BUNA N)	NEOPRENE	SILICONE	HYPALON	EPDM	POLIURETANO	POLIACRÍLICA	VITON	PTFE	COURO
DESIGNAÇÃO DO MATERIAL		BF/BG/BK									
Classificação ASTM D-200 SAE J200	NR/AA	CH/NRB	+BC,BE	SI/GE	CE	CA	AU/BG	DF/DH	HK	PTFE	-
Resistência a Tração (PSI)											
Borracha Pura	+de 3000	- de 1000	+de 3000	- de 1500	+de 1500	- de 1000	+de 4000	- de 1000	1200	-	-
Material com negro de fumo	+de 3000	+de 2000	+de 3000	+de 1500	0	+de 2000	-	+de 1000	1500 a 3000	-	-
FAIXA DUREZA 10D	30 - 90	40 - 95	40 - 95	40 - 85	40 - 95	30 - 90	60 - 98	45 - 90	50 - 90	50 - 65 shore D	-
PÊSO ESPECÍFICO	0,93	1	1,23	1,14 a 2,05	1,12	0,86	140	107	18	-	-
ADERÊNCIA A METAIS	E	E	E	E	E	R	MB	R	Rp/B	-	-
ADERÊNCIA A TECIDOS	E	B	E	E	B	B	B	-	B	-	-
RESISTÊNCIA AO RASGO	MB	R	B	M	R	R	+MB	R	Rp/B	-	-
RESISTÊNCIA A ABRASÃO	E	B	E	M	E	Bp/E	E	R	B	EX	E
DEFORMAÇÃO POR COMPRESSÃO	B	B	Rp/R	R	R	B	B	B	E	-	-
Resistência à Ácidos											
Diluídos	Rp/B	B	E	E	E	E	R	M	Rp/E	EX	R
Concentrados	Rp/B	B	B	R	B	B	M	M	E	EX	M
Resistência a Solventes											
Hidrocarbonetos alifáticos	M	E	Rp/B	M	Rp/B	M	+MB	B	E	EX	R
Hidrocarbonetos aromáticos	M	B	R	M	R	M	B	M	E	EX	R
Oxigenados (acetonas, etc.)	B	M	Mp/R	R	Mp/R	E	M	M	M	EX	B
Solventes de laca	M	R	M	M	M	Mp/R	M	M	Mr/R	EX	R
Resistência à:											
Inchamento em óleo lubrificante	M	MB	B	R	B	M	MB	E	E	EX	R
Gasolina	M	E	B	R	B	M	R	Rp/B	E	EX	B
Óleos animais e vegetais	Mp/B	MB	B	Bp/E	B	Bp/E	E	-	E	EX	R
Absorção à água	MB	B	B	E	B	E	B	M	MB	EX	B
Oxidação	B	B	MB	E	E	E	E	R	+E	EX	E
Ozônio	M	R	MB	E	+E	+E	E	MB	+E	EX	R
Envelhecimento pelo sol	M	M	MB	E	+E	+E	B	M	+E	EX	M
Envelhecimento pelo calor											
Baixas temperaturas	M	B	B	+E	MB	E	B	MB	+E	EX	B
Chama	MB	Rp/B	B	+E	B	E	-	M	Rp/B	-	-
	M	M	B	Rp/B	B	M	R	M	E	-	-

\* Produtos exclusivos da marca e qualidade DU'PONT



M - MAU

R - REGULAR

B - BOM

MB - MUITO BEM

E - EXCELENTE



# Retentores



INCOVE VEDAÇÕES LTDA.

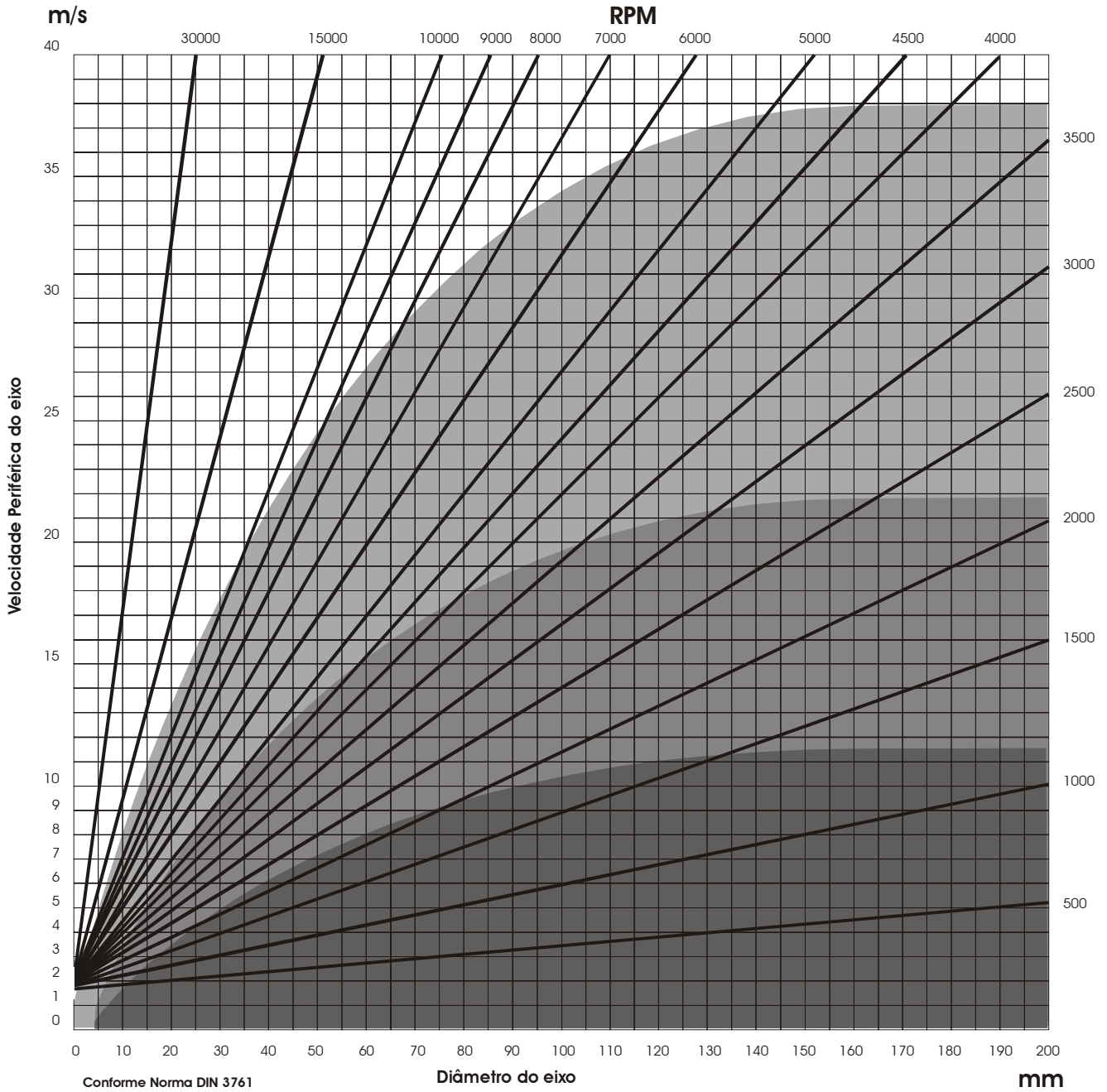

- NBR Nitrílica
- ACM Poliacrílica
- MVQ e FPM Silícone e Fluorelastômero





## Retentor

Pode-se definir um retentor convencional como um vedador dinâmico, possui um anel metálico para dar rigidez ao perfil e uma vedação de borracha acoplada com mola helicoidal.

Sua função é assegurar a vedação entre um eixo com movimento rotativo e uma base estacionária, através de uma carga prévia da borracha do lábio de vedação e da pressão de mola.

Os retentores admitem pequenos movimentos alternativos ou oscilantes, desde que projetados para vedar tais sistemas.

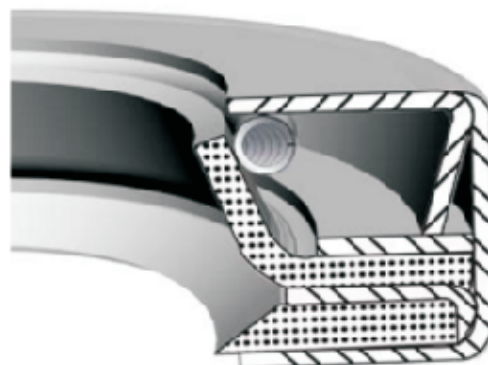

## 1- AUP

São vedadores tipo junta com a vedação em forma trapezoidal.

São aplicados em vedações de parafusamento e ligações por flanges.

Em algumas aplicações exige-se que o anel metálico seja de latão ou de alumínio.



## 2- TDUO

São vedadores para êmbolos completos de duplo efeito, de construção reduzida e máximo aproveitamento do curso.

Na necessidade de suportar pressão maior que a admissível, utilizam-se placas laterais com suportes.

São aplicados em vedadores de êmbolos de duplo efeito para sistemas pneumáticos ou hidráulicos de baixas pressões.

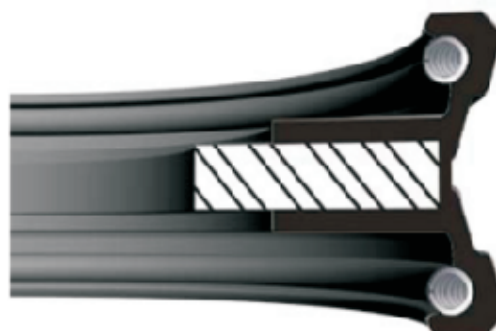

## 3- Raspador

É formado por uma peça moldada de borracha com um lábio de raspagem de ângulo positivo e uma seção rígida para montagem, com ou sem anel metálico. Consiste na função de remover poeira e partículas abrasivas que se depositam nas hastes de sistemas hidráulicos ou pneumáticos, com o objetivo de proteger as superfícies internas do equipamento.

Os modelos sem anéis metálicos possuem excelente rigidez e configuração geométrica adequada a raspagem.

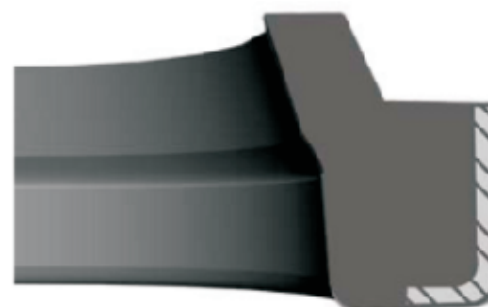





## RETENTORES

Os vedadores de óleo para eixos são necessariamente de tipo dinâmico, pois se destinam a assegurar vedação entre um eixo rotativo e um membro estacionário. Na grande maioria dos casos a pressão interna sob a qual o vedador trabalha é muito baixa. e assim, embora um vedador labial simples possa ser adequado para determinado serviço seu desempenho depende em grande parte de manter-se uma carga unitária adequada na interface vedador eixo. Isso pode ser obtido simplesmente por meio de uma carga prévia ou, mais usualmente, parte por uma carga prévia e parte pela pressão de uma mola.

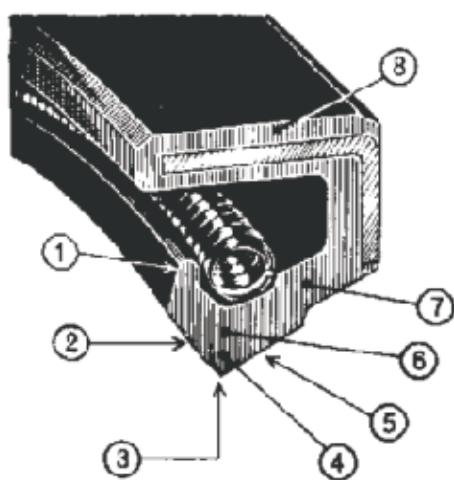

- 1- O alto rebordo assegura perfeita retenção da mola.
- 2- Um grande ângulo facial deixa a aresta bem por baixo da mola.
- 3- Contato na linha de vedação em forma de fio de navalha.
- 4- Linha de vedação reforçada contra ângulo interno.
- 5- O ângulo do eixo proporciona folga adequada.
- 6- Esta seção é reforçada para evitar deformação sob pressão.
- 7- Alma flexível.
- 8- A pele Gaco assegura impermeabilização aos fluidos com melhor adaptação.

Os requisitos da seção estão razoavelmente padronizados, resultando em semelhança geral de forma dos vedadores de óleo. A linha de contato efetivo aproxima-se, ou pode ter o mesmo a forma de um verdadeiro fio de navalha. Geralmente emprega-se um ângulo facial bastante grande no lado aberto da seção para que a linha de vedação fique bem por baixo da mola, e no outro lado dessa linha um ângulo um pouco menor proporciona uma folga adequada. E desejável usar-se, entre essas duas faces, um ângulo interno não muito fechado, para que a seção possua suficiente rigidez contra deformação local quando sob carga. A região inferior frontal é geralmente aliviada, para se obter flexibilidade.

## INSTALAÇÃO

O método normal de instalação consiste em montar o vedador com o lado aberto ou da mola voltado para o espaço a ser selado, embora haja exceções. Para fins de avaliação da carga radial, e conseqüentemente da pressão de contato, pode-se, contudo, medir diretamente a pressão de abertura do lábio aplicando ao vedador uma pressão de fora para dentro. Sem a mola, a vedação é realizada apenas pela carga prévia, que por sua vez depende do valor da interferência existente por ocasião da montagem do vedador. Com a mola, a carga radial, e portanto a pressão de abertura do lábio, pode tornar-se substancialmente mais elevada e menos afetada pelo grau de interferência.

Quase todos os vedadores desse tipo utilizam a pressão de uma mola adequada para criar uma carga radial sobre a linha de vedação. Emprega-se normalmente uma mola de tração, de espira simples, fechada, dimensionada especificamente para produzir a carga requerida ou de projeto quando distendida até seu comprimento normal de trabalho, isto é, o comprimento que de fato adquire quando o vedador está instalado. O projeto e a fabricação da mola podem constituir um fator crítico, pois o valor que, exprime sua rigidez é proporcional à quinta potência do diâmetro do fio e inversamente proporcional à terceira potência do diâmetro da espira, de modo que pequenas variações de qualquer dessas dimensões podem acarretar consideráveis diferenças naquele valor. Além disso, naturalmente, o uso de molas de diferentes características oferece um método para variar a pressão de abertura do lábio e a carga radial.

Quando montada inicialmente com interferência, a linha de vedação ficará em contato íntimo com o eixo e possivelmente um pouco distorcida, se tiver realmente a forma de um gume. Haverá um certo desgaste durante o período inicial de rotação do eixo, até que a linha de





vedação se amolde ao eixo e em seu lugar se forme uma área de contato perfeitamente caracterizada. Ao mesmo tempo se formará uma película de óleo sob o lábio, que flutuará sobre ela. O acabamento realiza-se normalmente num período de tempo bem pequeno, durante o qual o atrito cai rapidamente de um valor inicial bastante elevado até um valor constante mais baixo, geralmente da ordem de 50% do valor inicial, no caso dos vedadores

A película hidrodinâmica de óleo sobre a qual flutua o lábio do vedador pode ter uma espessura da ordem de apenas 2,5 µm. Não há uma concordância universal sobre o método pelo qual essa película de óleo estabelece uma vedação positiva, mas geralmente se admite que a película seja retida pela ação da tensão superficial, evitando-se assim sua evasão. A presença dessa película consistente é extremamente importante para a lubrificação do lábio do vedador, reduzindo o desgaste e o calor gerado pelo atrito. É igualmente importante para a manutenção de sua eficiência como um selo que sua espessura se conserve constante e que, assim, o menisco não se rompa.



Na prática, isso significa que o acabamento superficial do eixo na faixa de contato deve ser de alta qualidade. Riscos e outras imperfeições da superfície podem resultar em espessamento local e rompimento da película de óleo e, conseqüentemente, em vazamento.

As asperezas da superfície podem tomar a forma de picos que atravessam a película extremamente fina de óleo e estabelecem contato seco entre o eixo e o lábio do vedador, produzindo dessa maneira um grande desgaste.

Efeitos semelhantes podem resultar da presença de areia, poeira ou outro material abrasivo na massa do óleo (ou provenientes do exterior, em certas circunstâncias). Basicamente, portanto, um perfeito desempenho de um vedador

## DESGASTE MECÂNICO

O desgaste mecânico direto do vedador pode ser reduzido, ou virtualmente eliminado, pelo uso de um acabamento superficial adequado do eixo. Deve-se procurar obter um acabamento superficial com rugosidade

da ordem de  $Ra=0,4$  µm ou melhor, sendo que o tipo e acabamento também é importante. Assim, geralmente se prefere um acabamento por retificação, devendo-se ter um cuidado especial para que a superfície acabada não seja danificada de forma alguma durante o manuseio anterior à montagem final. Por esse motivo, em certos casos pode ser aconselhável temperar o eixo, embora isso possa não ser necessário do ponto de vista de resistência e não proporcione melhor superfície de vedação mas apenas como um fator adicional de garantia de manutenção do acabamento obtido.

A grosso modo, eixos de aço não temperados, de dureza Rockwell C 13 a 24, devem ser perfeitamente adequados para condições normais de serviço, desde que não haja perigo de que o eixo sofra danos ou arranhões em manuseio ou na montagem. Como proteção contra danos acidentais da superfície, ou para uso em condições de lubrificação deficiente ou em locais onde seja provável a presença de materiais abrasivos, o eixo deverá ter uma dureza mínima de Rockwell 40, para que seu desgaste se reduza a um valor sensivelmente baixo. Uma solução alternativa, por vezes adotada, consiste em cromar o eixo - cromação dura, cuidadosamente executada, pois uma cromação de má qualidade pode descascar e provocar a rápida destruição do lábio do vedador. No caso de eixos ou revestimentos de eixos de materiais que não o aço, é geralmente aconselhável consultar o fabricante do vedador sobre a adequabilidade e a seleção do material.

O tipo de elastômero usado no anel de vedação também tem alguma influência. Alguns materiais são mais elásticos, e portanto mais amoldáveis que outros, de modo que eles se adaptam melhor às irregularidades do eixo. Isso torna certos elastômeros mais adequados para vedação de eixos ligeiramente excêntricos ou ovalizados.

Além disso, os elastômeros de grande amoldabilidade requerem menor carga radial para selar qualquer eixo e conseqüentemente produzem menos atrito, que por sua vez gera menos calor.

## VIDA DO VEDADOR

A vida do vedador depende em grande parte da temperatura de trabalho do lábio de vedação, em falta de outras condições que possam provocar altas taxas de desgaste. O material do vedador deve ser escolhido primeiramente em função da temperatura de trabalho do fluido a ser vedado, sendo que qualquer aumento de temperatura localizado no lábio do vedador será causado pelo atrito, governado por fatores puramente mecânicos.

Quando expostos ao calor, os elastômeros tendem a endurecer e tornar-se quebradiços, e quanto mais longa a exposição ou mais alta a temperatura, mais pronunciados





serão os efeitos do envelhecimento. No caso extremo, o material pode tornar-se quebradiço a ponto de fender-se pela vibração ou perder virtualmente toda amoldabilidade e não vedar mais eficientemente. Um ponto interessante é que o fendimento por fragilização pode não ocorrer no local de trabalho, salvo se sujeito a choques mecânicos, como as vibrações e um vedador que tenha falhado por motivo de endurecimento pode fender-se apenas quando removido e distorcido mecânicamente. A inspeção visual do vedador no local de trabalho não dá, portanto, uma indicação segura do seu estado quando há suspeita de envelhecimento.

Basicamente, a vida de um elastômero será tanto mais longa quanto mais baixa for a temperatura do lábio do vedador. No caso de fluidos em baixa temperatura, uma temperatura excessiva do vedador é geralmente devida a uma carga radial excessiva, que pode resultar de mau projeto do vedador, mola inadequada ou tamanho inadequado do vedador e, conseqüentemente, excessiva carga prévia. Em princípio deve-se empregar a carga prévia mínima compatível com o exercício de uma vedação satisfatória, embora no projeto normalmente se preveja uma margem de segurança para garantir uma boa vedação - visto é, na prática, o projeto procura assegurar em primeiro lugar uma vedação satisfatória, ainda que utilizando uma carga prévia superior à estritamente necessária. Uma carga radial excessiva não produzirá melhor vedação, mas apenas excessivo calor gerado pelo atrito e possivelmente outras dificuldades que poderão causar a deterioração do vedador.

A Fig. abaixo mostra as características temperatura/vida de uma série de elastômeros. As curvas típicas da vida apresentam um envelhecimento rápido (vida curta) em altas temperaturas, terminando por nivelar-se em alguma temperatura mais baixa (vida longa).

Esse nivelamento dá uma indicação da temperatura máxima de trabalho do material em serviço contínuo, que deve estar preferivelmente acima da temperatura real de trabalho do vedador. Note-se que essa temperatura crítica é a temperatura de trabalho do lábio do vedador, que pode ser mais elevada que a temperatura da massa fluida.

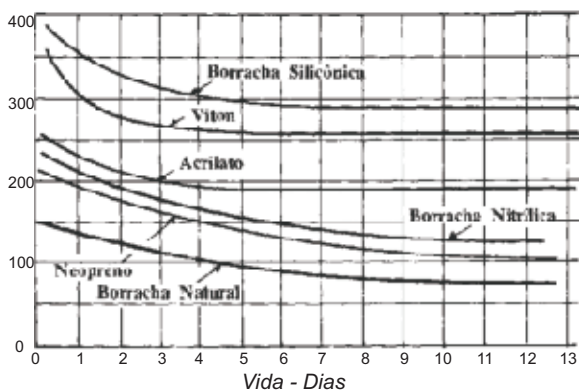

Características temperatura/vida de diversos elastômeros

Para serviços em temperaturas mais elevadas, há outros fatores a considerar além da escolha do elastômero. Assim, em temperaturas acima de 120°C, o material geralmente preferido para a mola é o aço inoxidável. Nessas temperaturas pode ser desejável, ou necessário, modificar o reforço metálico para que ele tenha a forma de uma capa ou revestimento e não de um inserto. Isso assegurará um ajuste mais consistente no diâmetro externo do vedador quando montado.

Em geral, para vedadores destinados a trabalhar em temperaturas muito elevadas, a borracha silicônica constitui a escolha lógica de material, oferecendo temperaturas máximas de serviço da ordem de 200 a 260°C, dependendo do grau. As borrachas silicônicas também possuem excelente amoldabilidade, o que as torna especialmente adequadas para vedadores de eixos de alta rotação bem como para aplicações de alta temperatura. As borrachas poliacrílicas, ao contrário, possuem baixa amoldabilidade e assim, embora interessantes como materiais para altas temperaturas, elas não são muito usadas para vedadores de eixos.

## EFEITOS DE PRESSÕES MUITO ELEVADAS

Quando um vedador de óleo do tipo convencional é submetido a pressões muito elevadas, a seção tende a deformar-se, modificando consideravelmente seu desempenho como vedador. A deformação principal ocorre no lábio, criando uma área de contato muito maior e conseqüentemente um grande atrito. Sua capacidade de vedação também pode ser afetada de modo adverso.

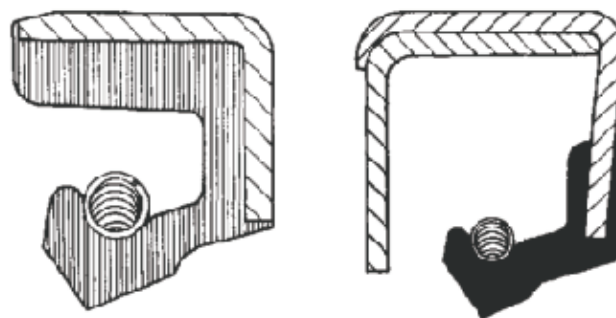

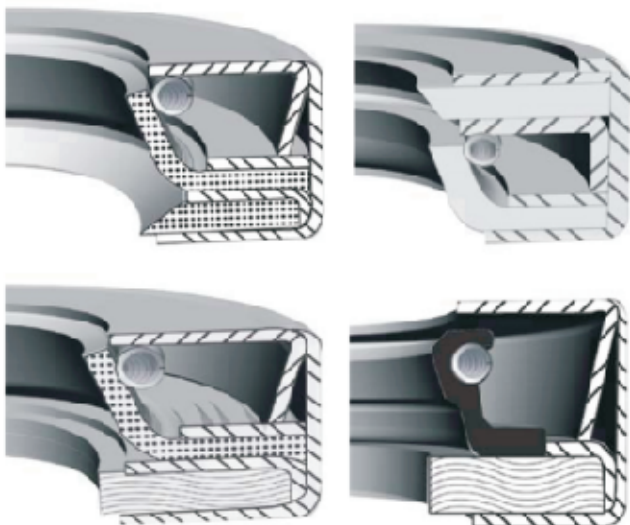

Tipos de vedadores de óleo para pressões mais altas (superfect)

Para pressões até aproximadamente 7 kgf/cm<sup>2</sup>, pode-se usar uma forma reforçada do mesmo tipo básico de vedador. O reforço pode consistir em uma arruela de apoio rígida de forma adequada ou na enquadramento da parte principal da seção do vedador em uma capa metálica rígida. Para trabalhos em pressões ainda mais elevadas, é comum recorrer-se a um tipo de vedador inteiramente diferente (por exemplo, um selo facial).

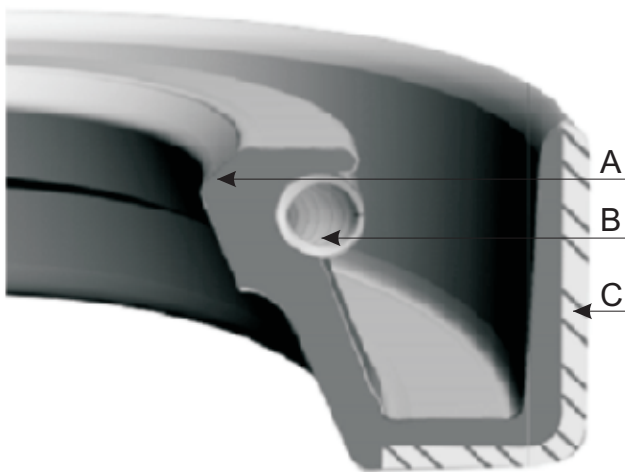

- A- Lábio de borracha
- B- Mola
- C- Vedador Walker Walkersele

Quando se usa um vedador com pressões acima das usuais, uma montagem forçada normal em prensa pode não ser suficiente para evitar que o vedador seja expulso de seu alojamento. Deve-se empregar algum método para impedir que o vedador se desloque para o lado da pressão baixa, a menos que ele esteja montado em um alojamento que tenha a extremidade cega no lado da pressão baixa ou esteja apoiado em um rebordo situado no lado da pressão baixa.

## VEDADORES NÃO METÁLICOS

Os vedadores de óleo não-metálicos compreendem normalmente uma seção flexível de borracha com um reforço de apoio de tecido em camadas, moldados como uma seção integral. O único componente metálico usado é a mola. Os vedadores de óleo desse tipo são especialmente adequados para serviços mais pesados e tamanhos maiores, mas também encontram grande aplicação onde a falha do vedador possa ter sérias consequências. A montagem é geralmente mais simples que para os vedadores de capa metálica e, além disso, há menos probabilidade de danos ao vedador devidos à falta de cuidado no manuseio ou na montagem. Uma outra grande vantagem é que esses vedadores podem ser facilmente cindidos para facilidade de montagem sem perda de eficiência, se devidamente alojados.

O vedador Walker Walkersele é um bom exemplo desse tipo.

## VEDAÇÃO CONTRA AREIA

Os vedadores de óleo convencionais possuem uma capacidade muito restrita de proteção contra a entrada de sujeira, areia etc. e, onde se requer especificamente essa proteção, deve-se preferir um selo facial. Entretanto, em certas circunstâncias o vedador simples de óleo pode oferecer proteção satisfatória. Quando usado para vedar graxas, por exemplo, a película de graxa que se forma sob o lábio do vedador pode constituir uma barreira efetiva contra a entrada de sujeira, desde que o ambiente externo seja razoavelmente seco. Se for úmido, essa proteção só pode ser assegurada empregando-se dois vedadores montados dorso contra dorso e enchendo-se de graxa o espaço entre eles. Se possível, deve-se prever um meio de substituir regularmente essa graxa, preferivelmente pelo uso de um bico de graxa.

Os pares de vedadores montados dorso contra dorso destinam-se a promover uma percolação da graxa em direção ao exterior, de modo que uma recarga de graxa expila qualquer areia ou outras partículas danosas que





tenham penetrado por baixo do vedador frontal juntamente com a graxa velha extrudada. É importante, portanto, ajustar a frequência de aplicação às condições ambientes, para que a câmara de graxa nunca fique fortemente contaminada. A temperatura da unidade de vedação também é importante, pois, para ser mais eficiente, a graxa deve ter boa fluidez, sem ser muito dura nem muito líquida, escolhendo-se em função disso o tipo adequado.

Incidentemente, quando se usa um vedador singelo para vedar graxa, a capacidade de vedação será virtualmente a mesma, qualquer que seja a posição em que se monte o vedador, o que significa que aparentemente ele pode ser montado na posição errada, se isso for mais conveniente para a instalação. Na vedação de óleo, a montagem em posição errada normalmente resulta em perda de eficiência e vazamento de óleo, mas isso pode ser vantajoso em certas circunstâncias. Para remover areia da parte externa do vedador.

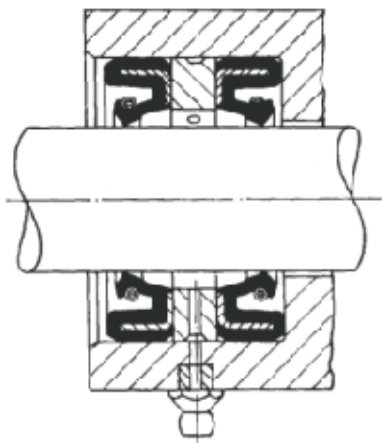

*Vedadores duplos com enchimento de graxa para vedação de partículas estranhas*

Para evitar o aumento de profundidade do alojamento, necessário quando se usam vedadores montados dorso contra dorso, podem ser empregados vedadores singelos bilabiais próprios para vedar em ambientes sujos. Os dois tipos principais são o vedador duplo e o semiduplo. Desses dois, normalmente o duplo apresentará um desempenho mais consistente, por ter os dois lábios tensionados por mola. Nenhum deles, contudo, é tão eficiente como o arranjo de vedadores gêmeos montados dorso contra dorso.

Outros tipos de arranjos incluem o uso de mantos, anéis raspadores, arruelas elásticas e dispositivos semelhantes, associados ou incorporados a uma seção

de vedador de óleo, convencional quanto aos demais aspectos. Desses tipos, o anel defletor é certamente o mais eficiente, sendo montado em um eixo e com ele girando. A força centrífuga tende a lançar para fora do vedador qualquer partícula de sujeira que atinja esse anel, obtendo-se uma proteção adicional dirigindo para trás a borda superior do anel defletor, sobre o alojamento do vedador.

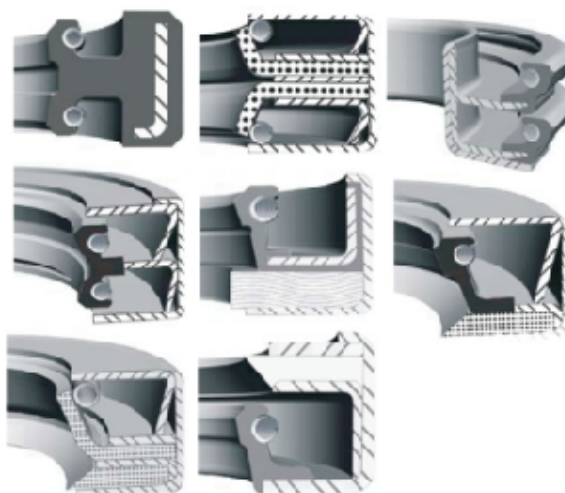

Em certas circunstâncias, quando se trabalha com grande fluxo de óleo, pode-se empregar vantajosamente um anel defletor montado no eixo adjacente à parte interna do vedador. Isso se destina a afastar do lábio do vedador a maior parte do fluxo de óleo e assim evitar que o vedador precise operar com uma quantidade excessiva de líquido. A lubrificação continua perfeitamente adequada e mantém-se pela película hidrodinâmica de óleo, reforçada por salpico ou jato de óleo. Apenas onde um vedador possa trabalhar realmente em seco durante um período de tempo, como por exemplo na partida ou antes de estabelecer-se a circulação de óleo, é que pode ser necessário assegurar lubrificação auxiliar por meio de uma bolsa de graxa ou alimentação de óleo separada; e mesmo assim nem sempre, pois o lubrificante residual retido quando se desliga o sistema pode ser suficiente para manter a lubrificação por ocasião da nova partida até que seja restaurada a circulação normal de óleo.

Para operação sob condições severas, pode-se usar um anel de couro em forma de chapéu, tensionado radialmente por uma mola, em vez de um anel elastomérico moldado convencional. A vantagem específica oferecida por um elemento de vedação de couro é que ele suporta melhor os efeitos da aspereza da







superfície e mesmo de partículas abrasivas do que os elastômeros. Além disso, seu lábio é muito menos suscetível de ser danificado pelas ranhuras ou rasgos de chaveta e assim pode ser manuseado mais despreocupadamente durante a montagem.

Um vedador desse tipo compreende normalmente um anel em forma de chapéu raso, feito de um couro tratado

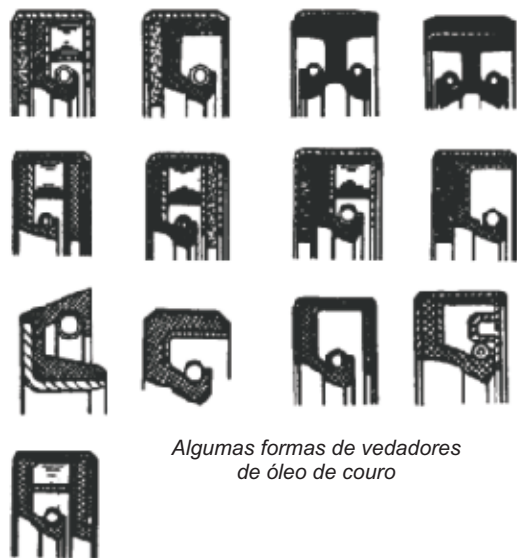

Algumas formas de vedadores de óleo de couro

adequado, contido e apoiado e uma capa metálica rígida. A capa também retém a mola que, sem isso, escaparia da parte superior da seção em chapéu. O lábio de vedação de couro possui excelente amoldabilidade e pode oferecer perfeita vedação com desgaste mínimo em superfícies ásperas, de rugosidade de até 1 1,1  $\mu m$ . As principais limitações estão na velocidade periférica máxima permissível da ordem de 450 m/s e na temperatura máxima de serviço de aproximadamente 800°C. Também o atrito é substancialmente maior que o dos vedadores de óleo convencionais. Entretanto, ele pode ser usado em meios abrasivos e também como vedador de areia ou partículas estranhas e também com um vedador de óleo convencional. Em outros modelos destinados a operar em ambientes arenosos pode-se introduzir uma arruela de couro na mesma capa ou alojamento que um vedador elastomérico convencional.

Um outro tipo de vedador de óleo é o destinado a proteger rolamentos de esferas contra a entrada de poeira ou sujeira e também a reter o lubrificante original no rolamento (normalmente graxa). Esses vedadores são fabricados em seções e tamanhos especiais, adaptados às faces de rolamentos específicos, e, como eles devem ser estreitos, a mola é omitida. O fechamento do lábio de

vedação, portanto, depende inteiramente da flexibilidade do elastômero empregado e a eficiência do vedador na retenção do lubrificante dentro do rolamento é limitada.

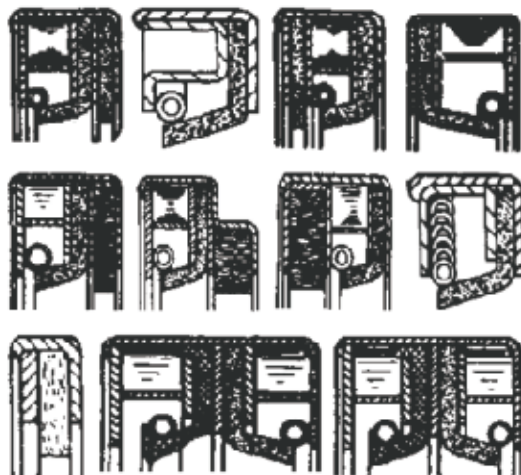

Esses vedadores geralmente retêm graxa eficientemente, mas não óleo.

## EXCENTRICIDADE E DESALINHAMENTO

O desempenho de um vedador de lábio simples pode ser adversamente afetado por excentricidade do eixo ou do alojamento.

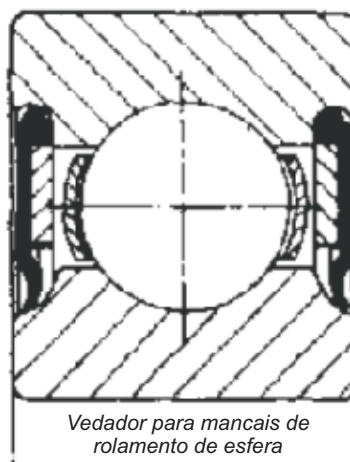

Vedador para mancais de rolamento de esfera

A excentricidade do eixo provoca um desbalanceamento dinâmico que só pode ser compensado pela amoldabilidade do vedador, proporcionada pela flexibilidade do material e da própria seção. Na prática, isso pode ser expresso em termos de máxima excentricidade permissível para um dado material e um dado modelo de vedador,

estabelecendo-se limites dentro dos quais a amoldabilidade do vedador seria satisfatória. Isso também dependerá, naturalmente, da velocidade de rotação do





eixo, pois quanto maior for a frequência do deslocamento cíclico, menor será a excentricidade que o vedador poderá suportar. Note-se, entretanto, que o desempenho de determinada seção pode ser modificado a) pelo aumento da pressão da mola e b) pelo uso de um elastômero mais flexível, capaz de adaptar-se a uma excentricidade maior; ou em casos extremos pode ser necessário redesenhar a seção para se obter maior flexibilidade.

A excentricidade do alojamento é na realidade muito menos importante, pois produz apenas uma distorção estática do vedador na direção radial, que pode ser absorvida pela interferência normal, se não for muito severa. Caso necessário, pode-se criar uma interferência adicional do lábio do vedador para fazer face a uma excessiva excentricidade do alojamento ou então uma eventual distorção do alojamento.

O efeito de montar-se um vedador fora de esquadro em seu alojamento é geralmente ainda menos importante, desde que o deslocamento geométrico seja praticamente desprezível, isto é, não seja superior a 5°. Esse valor situa-se normalmente dentro das tolerâncias específicas para a usinagem do alojamento, devendo seguir-se uma montagem razoavelmente cuidadosa.

## OUTROS MÉTODOS DE MONTAGEM

Normalmente um vedador de óleo é uma unidade estacionária, montado dentro de um alojamento em torno de um eixo rotativo. Pode haver aplicações, contudo, em que um vedador seja montado em um membro girante em torno de um eixo estacionário, caso em que se pode usar um vedador normal, e outras, em que o desenho do vedador possa ser invertido para que ele se transforma em um vedador de tipo externo. Os dois casos normalmente exigem alguma modificação na forma da mola

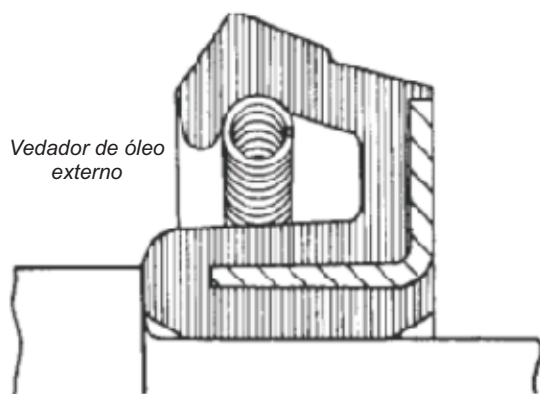

Vedador de óleo externo

No caso de vedador rotativo, a carga radial efetiva será alterada pela força centrífuga e, em velocidades de rotação acima aproximadamente de 1.000 rpm, especialmente nos vedadores de maior tamanho, pode ser necessário aumentar a pressão da mola para manter pressão adequada do lábio sobre o eixo. Embora isso seja uma solução óbvia, tem a desvantagem de aumentar a pressão de contato em baixas velocidades e conseqüentemente a quantidade de calor gerada pelo atrito nessas velocidades. Em velocidades muito altas, essa diferença e a dificuldade de estabelecer-se a pressão mais favorável da mola em velocidades correntes de trabalho podem excluir o uso de vedadores labiais nos casos em que o vedador deva girar.

Nos vedadores externos, é igualmente crítica a determinação da pressão mais favorável da mola. Eles apresentam, além disso, um problema de produção, pois para se evitar uma alta taxa de desgaste do vedador é necessário que a superfície sobre a qual corre o lábio do vedador tenha um acabamento fino.

## VEDADORES CINDIDOS

Em lugares onde seja impraticável montar um vedador inteiriço, pode-se empregar um vedador cindido. Embora por outro lado possuam seção e construção convencionais, esses vedadores são fabricados especialmente como tais e só devem ser manuseados em conformidade com as especificações do fabricante. Assim, alguns vedadores cindidos tem a capa metálica separada em duas partes e podem ser abertos para montagem por meio de uma articulação. Outros precisam ser abertos com um movimento de torção, deslocando-se as duas faces cortadas em uma direção axial apenas o necessário para se obter a folga requerida para montagem no eixo. Depois que o vedador esteja em posição, coloca-se a mola. Ela pode possuir gancho e olhal para ser montada como mola circular ou pode também ser montada por meio de torção e rosqueamento de suas extremidades.

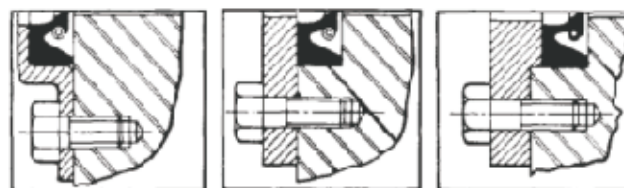

Vistas seccionais de vedadores de óleo cindidos em diferentes tipos de alojamento





Adequadamente tratado e corretamente instalado, um vedador cindido deve ter o mesmo desempenho que um anel inteiriço, desde que a junta de topo do vedador não coincida com alguma divisão ou junta da placa retentora. Normalmente o vedador deve ser colocado no alojamento com o corte no ponto mais alto do eixo, quando possível. O vedador deve então ficar preso por uma placa de cobertura ou placa retentora adequada que, além de suportá-lo, assegura um alinhamento correto das bordas cortadas uma em relação à outra. As placas de cobertura devem ser suficientemente rígidas para não sofrerem abaulamento ou distorção quando apertadas, e os parafusos de fixação devem ficar o mais próximo possível da cavidade do alojamento.

## SELEÇÃO DE VEDADORES DE ÓLEO

Na maioria das aplicações em que é adequado um vedador labial singelo convencional, a seleção do vedador baseia-se em sete fatores básicos: diâmetro do eixo, diâmetro e largura do alojamento, velocidade de rotação do eixo, temperatura de trabalho, líquido, diferença de pressão e condições de serviço.

### DIÂMETRO DO EIXO

O tamanho do vedador (número do tipo) baseia-se no tamanho do eixo, prevendo-se uma interferência e uma pressão da mola nominais compatíveis com a montagem no eixo de referência.

Os afastamentos permissíveis dos diâmetros dos eixos, para fins de montagem de vedadores de tamanho especificado em função desses diâmetros, são da seguinte ordem de grandeza:

Eixos de diâmetro até 24,99 mm .....	=ou- 0,05 mm
Eixos de diâmetro 20,00 mm até 99,99 mm .....	=ou- 0,10 mm
Eixos de diâmetro 100,00 mm até 199,99 mm .....	=ou- 0,15 mm
Eixos de diâmetro 200,00 mm até 399,99 mm .....	=ou- 0,20 mm
Eixos de diâmetro a partir de 400,00 mm .....	=ou- 0,25 mm

### DIÂMETRO E LARGURA DO ALOJAMENTO

Cada vedador correspondente a determinado tamanho de eixo deve ter um diâmetro externo e uma largura compatíveis com a forma geométrica do alojamento requerida para montagem satisfatória, devendo-se prever uma interferência necessária para a obtenção de um selo impermeável ao líquido.

Os afastamentos permissíveis do diâmetro interno de alojamentos usinados são normalmente da ordem de 0,025mm para diâmetros de 100 a 175mm e de 0,050mm

para diâmetro acima de 175mm. Note-se, entretanto, que, para alguns tipos de vedadores providos de capas ou insertos metálicos rígidos, o alojamento deve ser usinado com o diâmetro interno em submedida em relação ao diâmetro externo do vedador, de modo que se obtenha a interferência desejada. É importante que a superfície interna do alojamento tenha um acabamento fino e seja isenta de riscos longitudinais, que poderiam formar uma via de vazamento; e que seja previsto na face de entrada do alojamento um chanfro de dimensões razoáveis, para facilitar a montagem do vedador e evitar danos.

## VELOCIDADE DE ROTAÇÃO DO EIXO

Normalmente são estabelecidos limites para a velocidade periférica de determinado tipo de vedador e pode-se admitir que qualquer velocidade de deslizamento até esse limite seja aceitável. Um limite típico é 1000 m/s. A esse respeito, deve-se ter em mente que, no caso de eixos de pequeno diâmetro, devem ser observadas as próprias velocidades de rotação, tanto como as velocidades periféricas, e que é normalmente indesejável ultrapassar os seguintes valores de rpm com vedadores de óleo de tipo padrão:

Eixos de diâmetro até 32mm 7000 a 8000 rpm

Eixos de diâmetro entre 64 mm e 75 mm 3000 a 4000 rpm

Os limites nominais para os valores intermediários de diâmetros de eixos podem ser estimados por interpolação. Para eixos de diâmetro acima de 75mm, o limite de rpm pode ser estimado apenas em função da velocidade periférica.

Um outro ponto a considerar é que, para aplicações de baixas e médias velocidades de rotação, pode ser preferida uma forma de vedador um pouco modificada, com um lábio mais largo. Tais vedadores terão um limite mais baixo para a velocidade periférica máxima permissível. Analogamente, terão limite de velocidade mais baixo os vedadores labiais destinados a resistir a pressões internas superiores a 0,35 a 0,70 kgf/ cm<sup>2</sup>, que é a faixa nominal característica de vedadores de óleo convencionais.

Deve-se notar que, embora o acabamento superficial e a velocidade periférica sejam fatores críticos para o desgaste e a vida de um anel de vedação, não há relação direta entre os dois. Melhor esclarecendo, a ocorrência de desgaste dependerá especificamente de um acabamento superficial liso e será independente da velocidade periférica. Uma redução da velocidade periférica não compensará a aspereza da superfície; um anel elastomérico sofrerá desgaste inevitavelmente, com qualquer velocidade de rotação, se o acabamento





superficial tiver rugosidade acima de 0,5 IJ.m. O único meio prático de acomodar uma rugosidade superficial dessa ordem, ou ainda maior, consiste no emprego de um material mais resistente à abrasão do que os elastômeros normais, tal como o couro.

Para serviços alternativos, é geralmente necessário usar um vedador modificado, de lábio mais espesso. Nesses casos, os limites de velocidade são normalmente especificados pelo fabricante; 12 m/min é um valor típico.

## TEMPERATURA DE TRABALHO

A importância da temperatura de trabalho já foi discutida em detalhe. Um vedador de tamanho correto assegurará a carga radial mais favorável quando devidamente instalado. A temperatura da massa líquida pode ditar o material do vedador.

## LÍQUIDO

O líquido afetará diretamente a escolha do material do vedador em termos de compatibilidade na temperatura de trabalho prevista. Podem surgir problemas especiais quando o líquido não é óleo limpo, refletindo-se possivelmente no tipo de vedador adequado ou criando a necessidade de prever proteção para o vedador. Se for água o fluido vedado, um vedador de tipo facial ou um vedador especial para água oferecerá normalmente melhor desempenho que um vedador labial simples.

## DIFERENÇA DE PRESSÃO

Como regra geral, os vedadores de óleo de lábio padronizado terão desempenho satisfatório para diferenças de pressão de até 0,7 ou possivelmente 1kgf/cm<sup>2</sup>. Para vedar pressões de líquido mais elevadas, pode ser necessário o uso de um tipo modificado de vedador, com um lábio de seção mais espessa ou com uma arruela de apoio. Esses vedadores podem ter desempenho satisfatório até 7kgf/cm<sup>2</sup>. Para maiores diferenças de pressão, devem ser usados selos de tipo especial, como os selos faciais.

## CONDIÇÕES DE SERVIÇO

As condições de serviço podem introduzir fatores tendentes a prejudicar o desempenho do vedador e podem impor modificação na escolha do tipo de vedador. Se houver probabilidade de ocorrerem severas condições de serviço ou se um vedador de tipo padrão falhar prematuramente, devem ser consultados os fabricantes especializados de vedadores. Também pode

acontecer que se torne possível determinar a causa provável do desempenho insatisfatório em vista das descrições prévias.

## MONTAGEM DE VEDADORES DE ÓLEO

A causa mais comum de falha de vedadores de óleo consiste em danos produzidos no vedador durante o manuseio, durante a estocagem ou, mais freqüentemente, na montagem. Nunca será demais insistir sobre a necessidade de sempre manusear os vedadores com o máximo cuidado. Eles devem ser conservados em atmosfera limpa e seca (preferivelmente em recipientes impermeáveis ao ar) e nunca devem ser amontoados ao acaso, pois isso permitiria que os lábios de vedação se danifiquem.

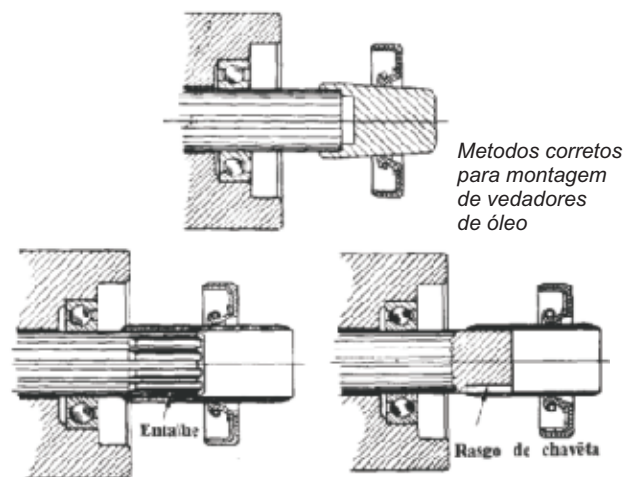

Metodos corretos para montagem de vedadores de óleo

Antes de montar um vedador, deve-se examiná-lo cuidadosamente para verificar se o lábio não está arranhado ou danificado, se a mola está colocada corretamente e se o vedador está limpo e sem poeira. O lábio pode ser então recoberto de graxa limpa imediatamente antes da montagem. O método de montagem empregado dependerá da seqüência das operações: ou o vedador é instalado inicialmente sobre o eixo e em seguida introduzido no alojamento sob pressão, ou então ele é inicialmente introduzido sob pressão no alojamento e montado no eixo. Deve-se preferir o primeiro método sempre que possível.

Recomenda-se o uso de uma luva cênica ou peça equivalente para montar o vedador sobre o eixo, sendo que essa providência é virtualmente indispensável quando o vedador precisa passar sobre o rasgo da chave de um eixo entalhado. O avanço do vedador será facilitado por







um ligeiro movimento de rotação.

Para introduzir o vedador no alojamento sob pressão, usa-se uma peça em forma de campânula, de diâmetro

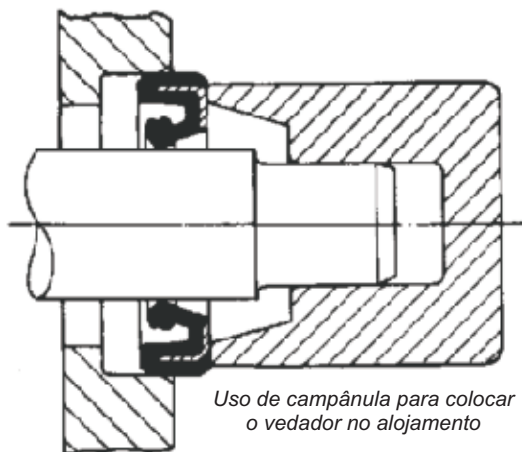

*Uso de campânula para colocar o vedador no alojamento*

ligeiramente inferior ao diâmetro do vedador, à qual se aplica uma pressão firme e uniforme, preferivelmente por meio de uma prensa. Pode-se engraxar levemente o lado externo do vedador para auxiliar sua introdução, que

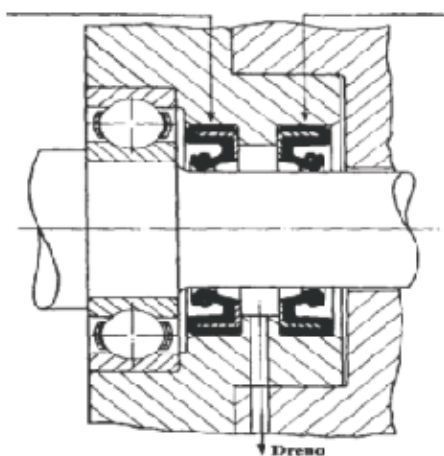

*Conjunto de vedadores montados dorso contra dorso para separar óleo de câmbio e óleo hidráulico*

também é facilitada pelo chanfro de entrada do alojamento. O vedador é então forçado a penetrar até o fundo, em esquadro, devendo-se completar o processo de montagem em uma operação contínua, para que o

vedador não seja submetido a uma carga ou tensão anormal. Normalmente assegura-se um alinhamento correto pela ação auto-orientadora da peça em forma de campânula, que se posiciona sobre o eixo ou no furo do eixo à medida que o vedador avança em direção ao alojamento. A borda de ataque da peça deve ter forma apropriada para se adaptar ao tipo de vedador que se está montando. Quando se monta o vedador com o dorso para a frente, a peça em forma de campânula pode desviar-se da mola e assim permitir a montagem do vedador completo (com a mola). Também pode ser necessário remover a mola para introduzir o vedador e recolocá-la quando o vedador estiver em posição.

Como regra geral, sempre que se remove um vedador por qualquer razão, como por exemplo durante uma desmontagem do equipamento, ele deve ser abandonado e substituído por um novo. O custo da substituição é geralmente desprezível em comparação com os inconvenientes e a necessidade de nova desmontagem que adviriam se o vedador original se danificasse na desmontagem e reinstalação, como seria muito provável.







**INCOVE**<sup>®</sup>  
INCOVE VEDAÇÕES LTDA.

**REtentor**



# Retenfores

Perfis - Ver Última Página



INCOVE VEDAÇÕES LTDA.

Cod.	Di	De	Ha1	Ha2	Mod	Cod.	Di	De	Ha1	Ha2	Mod	Cod.	Di	De	Ha1	Ha2	Mod
18352	2.38	12.70	4.76	---	I4BA	12587	6.00	19.00	7.00	---	I5BB	---	7.80	13.80	3.60	---	I4BB
---	2.38	12.70	4.76	---	I4B.	16725	6.00	19.15	6.35	---	I5BB	---	7.80	14.00	3.50	---	I4BB
---	3.00	10.00	6.00	---	I4BB	---	6.00	20.00	7.00	---	I2BB	---	7.80	14.60	4.80	---	I4BA
20418	3.00	10.00	6.00	---	I5BB	20408	6.00	20.00	7.50	---	TDUO	20411	7.80	53.00	20.00	---	TDUO
18364	3.97	19.05	6.35	---	I4BA	20408	6.00	20.00	7.50	---	TDUO	---	7.90	14.30	5.00	---	I4BB
12111	4.00	8.00	2.00	---	I4BA	20428	6.00	20.00	11.00	---	I5BA	---	7.90	14.60	5.00	---	I4BB
20419	4.00	11.00	6.00	---	I5BB	---	6.00	22.00	7.00	---	I2BB	---	7.90	14.70	5.00	---	I5BB
20420	4.00	12.00	6.00	---	I5BB	20429	6.00	22.00	7.00	---	I5BB	---	7.90	16.00	6.00	---	I5BB
20368	4.00	70.00	18.00	---	TDUO	---	6.00	22.00	8.00	---	I2BB	---	7.90	23.20	2.90	7.00	I2BB
20244	4.45	15.85	6.60	---	TDUO	20430	6.00	22.00	8.00	---	I5BB	20152	7.90	25.50	7.00	---	I5BA
20137	4.50	9.60	3.50	---	I4BA	11202	6.00	30.00	7.00	---	I2BB	20152	7.90	25.50	7.00	---	I5B.
---	4.50	9.70	3.50	---	I4BB	---	6.34	19.00	6.15	---	I5BB	---	7.93	16.00	4.36	---	I4BB
---	4.50	16.00	7.50	---	I4BB	14886	6.35	7.94	3.97	---	I4BA	---	7.93	19.70	6.35	---	I5BB
---	4.70	16.00	7.50	---	I4BB	13604	6.35	9.53	6.35	---	I4BA	18949	7.93	20.64	6.35	---	I5B.
12668	4.76	15.88	4.76	---	I4BA	20345	6.35	11.11	3.17	---	I4BA	---	7.93	25.37	9.52	---	I5BB
18901	4.76	15.88	6.35	---	I4BB	16999	6.35	12.70	3.17	---	I4BA	18947	7.94	12.70	3.17	---	I4BA
19986	4.76	61.91	7.94	---	I13	16999	6.35	12.70	3.18	---	I4BA	20440	7.94	14.29	3.00	---	I5BB
18310	4.76	63.50	7.94	---	I5BB	18933	6.35	12.70	4.76	---	I4BA	18948	7.94	14.29	3.17	---	I4BA
---	4.80	14.30	6.50	---	I4BB	18933	6.35	12.70	4.76	---	I4B.	18948	7.94	14.29	3.17	---	I4B.
---	4.80	22.00	7.00	---	I2BB	14887	6.35	14.29	3.17	---	I4JM	12262	7.94	14.29	3.57	---	I4BA
12112	5.00	9.00	2.00	---	I4BA	11011	6.35	14.29	6.35	---	I5BB	17910	7.94	15.86	9.52	---	I1FB
12113	5.00	10.00	2.00	---	I4BA	20431	6.35	14.29	6.35	---	I5B.	13409	7.94	15.88	3.97	---	I4BA
11508	5.00	12.00	5.00	---	I5BB	20432	6.35	14.50	7.00	---	I2BB	17573	7.94	15.88	6.35	---	I4BA
12190	5.00	13.00	4.50	---	I4BA	13530	6.35	15.88	6.35	---	I5BA	15673	7.94	17.46	6.35	---	I4BB
---	5.00	15.00	4.00	---	I2BB	20433	6.35	16.27	6.35	---	I5BA	20441	7.94	17.46	6.35	---	I2BA
20421	5.00	15.00	6.00	---	I5BB	---	6.35	19.05	5.55	---	I4BB	18193	7.94	17.46	7.94	---	I5BA
---	5.00	16.00	6.00	---	I2BB	13388	6.35	19.05	6.35	---	I5BB	18193	7.94	17.46	7.94	---	I5BB
12603	5.00	16.00	6.50	---	I5BB	17337	6.35	19.05	6.35	---	I4B.	18193	7.94	17.46	7.94	---	I5B.
16663	5.00	16.00	7.00	---	I5BA	13388	6.35	19.05	6.35	---	I5BB	18193	7.94	17.46	7.94	---	I5C
16458	5.00	17.00	7.00	---	I5BB	13388	6.35	19.05	6.35	---	I5BA	---	7.94	18.26	6.35	---	I4BB
12011	5.00	18.00	4.50	---	I4BA	20434	6.35	19.05	6.35	---	I5B.	17890	7.94	19.05	3.97	---	I4BA
16617	5.00	19.00	6.00	---	I5B.	16587	6.35	19.05	7.00	---	I5BA	20376	7.94	19.05	4.76	---	I5BB
20422	5.00	22.00	8.00	---	I5BB	---	6.35	19.05	11.91	---	I9B	20376	7.94	19.05	4.76	---	I5BB
11889	5.00	32.00	19.00	---	TDUO	18250	6.35	19.05	12.70	---	I1FB	17289	7.94	19.05	6.35	---	I5BA
11889	5.00	32.00	19.00	---	TDUO	20435	6.35	22.23	6.35	---	I5BB	20442	7.94	19.05	7.94	---	I5BA
14781	5.00	35.00	14.00	---	ESPE	19022	6.35	22.23	6.35	---	I5B.	20443	7.94	19.05	8.73	---	I5BB
---	5.50	9.20	7.00	8.00	ESPE	15029	6.35	25.40	6.35	---	F	17898	7.94	19.05	9.53	---	I5BA
20423	5.50	16.00	6.00	---	I5BB	15806	6.35	25.40	6.35	---	I4B.	20444	7.94	19.84	7.94	---	I5BB
---	5.50	16.00	7.50	---	I4BB	20151	6.35	25.40	8.00	---	ESPE	18192	7.94	19.84	7.94	---	I5B.
---	5.50	16.00	8.00	---	ESPE	20151	6.35	25.50	8.00	---	I4BA	18949	7.94	20.64	6.35	---	I5B.
16906	5.50	18.00	8.00	---	I7BA	16443	6.40	12.50	5.00	---	I4BA	15028	7.94	20.64	6.35	---	I1FB
---	5.55	25.32	4.76	---	I4BB	---	6.50	14.50	7.00	---	I2BB	14047	7.94	20.64	12.70	---	I7BA
---	5.56	25.40	6.75	---	I4BA	13924	6.50	28.50	4.70	---	I4JM	11074	7.94	22.22	6.35	---	I5BB
17752	5.56	25.40	7.94	---	I4BA	12572	6.60	12.70	3.00	---	I4BB	11074	7.94	22.23	6.35	---	I5BB
15969	5.80	98.43	17.46	---	I12B	---	6.75	12.85	3.18	---	I4BA	11297	7.94	22.23	6.35	---	I2BB
12520	6.00	10.00	2.00	---	I4BA	16474	6.80	22.20	7.00	---	I2BB	19935	7.94	22.23	6.35	---	I551
---	6.00	10.00	2.50	---	I4BB	12115	7.00	11.00	2.00	---	I4BA	18365	7.94	22.23	7.94	---	I5BB
---	6.00	11.00	4.00	---	I2BB	---	7.00	12.00	4.00	---	I4BA	18365	7.94	22.23	7.94	---	I5B.
12114	6.00	12.00	2.00	---	I4BA	12116	7.00	14.00	2.00	---	I4BA	18365	7.94	22.23	7.94	---	I5B.
13949	6.00	12.00	4.00	---	I4BA	14879	7.00	14.00	3.00	---	I4BA	18365	7.94	22.23	7.94	---	I5BB
---	6.00	12.85	4.70	---	I4BA	14879	7.00	14.00	3.00	---	I4BA	15924	7.94	22.23	14.29	---	I7B.
---	6.00	13.00	1.50	2.00	AUP	12893	7.00	14.00	4.00	---	I4BB	20445	7.94	23.81	7.94	---	I5BB
20424	6.00	13.50	7.00	---	I5BB	---	7.00	16.00	7.00	---	I2BB	15333	7.94	23.81	7.94	---	I5B.
---	6.00	14.00	5.00	---	I4BB	11782	7.00	16.00	7.00	---	I5BA	15333	7.94	23.81	7.94	---	I5B.
22492	6.00	15.00	4.00	---	I5BB	11782	7.00	16.00	7.00	---	I5BB	20147	7.94	25.40	3.17	---	I4BA
12014	6.00	15.00	7.00	---	I5BB	20436	7.00	16.00	7.00	---	I5BA	20147	7.94	25.40	3.18	---	I4BA
20425	6.00	16.00	5.00	---	I5BB	20437	7.00	17.00	7.00	---	I5BB	17507	7.94	25.40	9.53	---	I5BA
---	6.00	16.00	6.00	---	I2BB	16585	7.00	19.00	6.00	---	I5BA	20446	7.94	25.40	9.53	---	I5BA
---	6.00	16.00	6.50	---	I2BB	20438	7.00	19.00	7.00	---	I5BB	18366	7.94	28.58	9.53	---	I5B.
13799	6.00	16.00	7.00	---	I5BB	---	7.00	20.00	7.00	---	I2BB	20447	7.94	28.58	9.53	---	I5BB
20278	6.00	16.00	7.00	---	I2BB	---	7.00	22.00	7.00	---	I2BB	18366	7.94	28.58	9.53	---	I5BA
13799	6.00	16.00	7.00	---	I5BB	19023	7.00	22.00	7.00	---	I5BB	18366	7.94	28.58	9.53	---	I5B.
---	6.00	16.00	7.50	---	I4BB	20439	7.00	22.00	10.00	---	I5BB	18950	7.94	31.75	4.76	---	I4BA
16879	6.00	18.00	8.00	---	I7BA	14084	7.00	22.00	10.00	---	I5B.	20448	7.94	31.75	9.53	---	I5BB
20427	6.00	19.00	6.00	---	I5BB	20303	7.00	25.00	8.50	---	TDUO	14762	7.94	33.34	3.17	---	I4B.
---	6.00	19.00	7.00	---	I2BB	20303	7.00	25.00	8.50	---	TDUO	18368	7.94	34.93	6.35	---	I4BA
12587	6.00	19.00	7.00	---	I5BB	25391	7.00	25.00	10.00	---	TDUO	---	8.00	10.80	6.20	10.20	ESPE



# Retentores

Perfis - Ver Última Página



INCOVE VEDAÇÕES LTDA.

Cod.	Di	De	Ha1	Ha2	Mod	Cod.	Di	De	Ha1	Ha2	Mod	Cod.	Di	De	Ha1	Ha2	Mod
12117	8.00	12.00	3.00	—	14BA	20140	8.00	35.00	13.00	—	1800	14816	9.53	15.88	6.35	—	14BA
12117	8.00	12.00	3.00	—	14BB	20140	8.00	35.00	13.00	—	ESPE	19933	9.53	17.46	6.35	—	12BA
12117	8.00	12.00	3.00	—	14BA	16636	8.00	35.00	15.00	—	TDUO	15583	9.53	19.05	4.76	—	15BB
—	8.00	12.00	8.80	—	ESPE	13226	8.00	35.00	16.00	—	ESPE	—	9.53	19.05	6.35	—	14BA
—	8.00	13.20	7.50	9.30	ESPE	20340	8.00	35.00	18.00	—	TDUO	—	9.53	19.05	6.35	—	14C
—	8.00	14.00	3.00	—	14BB	20360	8.00	60.00	18.00	—	TDUO	20466	9.53	19.05	6.35	—	15BB
—	8.00	14.00	3.00	—	15BB	F1316	8.50	13.40	1.00	1.50	AUP	20141	9.53	19.05	6.35	—	15BA
—	8.00	14.00	3.00	—	15BB	13169	8.50	14.50	1.50	—	14BA	20141	9.53	19.05	6.35	—	15BA
20138	8.00	14.00	3.60	—	14BB	13168	8.50	16.00	6.50	—	15BB	20142	9.53	19.05	7.00	—	15BB
—	8.00	14.00	6.00	—	14BA	13168	8.50	16.00	6.50	—	15BB	20467	9.53	19.05	7.14	—	15BB
12328	8.00	14.00	6.20	10.00	15BA	16620	8.50	23.00	7.00	—	15BB	—	9.53	21.03	4.76	—	14BA
—	8.00	14.00	8.90	13.00	ESPE	18951	8.73	15.08	2.38	—	14BA	20468	9.53	21.03	4.76	—	15BB
—	8.00	14.10	7.10	10.40	ESPE	—	8.73	17.46	3.57	—	14BA	13391	9.53	21.43	4.76	—	14BA
—	8.00	14.10	7.10	10.40	ESPE	17289	8.73	19.05	6.35	—	15BA	—	9.53	21.43	4.76	—	14BA
—	8.00	14.10	13.00	—	ESPE	17289	8.73	19.05	6.35	—	15B.	17415	9.53	21.43	7.94	—	15BA
—	8.00	15.00	3.00	—	14BB	—	8.73	22.23	6.35	—	14BB	20109	9.53	22.22	10.00	—	15BB
12118	8.00	15.00	3.00	—	14BA	—	8.73	22.23	6.35	—	14BA	20109	9.53	22.22	10.00	—	15BB
—	8.00	15.00	5.50	—	15BB	20148	8.73	22.23	6.35	—	15BB	17459	9.53	22.23	6.35	—	15BB
16242	8.00	16.00	4.50	—	15BB	17228	8.73	25.40	9.52	—	15B.	17459	9.53	22.23	6.35	—	15BA
—	8.00	16.00	6.00	—	14BB	20460	8.73	25.40	9.53	—	15BB	20469	9.53	22.23	7.94	—	15BB
—	8.00	16.00	7.00	—	12BB	11301	8.80	18.00	5.00	—	15BB	20149	9.53	22.23	7.94	—	15B.
14101	8.00	16.00	7.00	—	15BA	12119	9.00	13.00	3.00	—	14BA	20470	9.53	23.02	4.52	—	15BB
14101	8.00	16.00	7.00	—	15BB	12329	9.00	15.00	10.00	14.00	ESPE	18921	9.53	23.02	6.35	—	14BB
14101	8.00	16.00	7.00	—	15BA	12120	9.00	16.00	3.00	—	14BA	—	9.53	23.02	6.35	—	14BA
14101	8.00	16.00	7.00	—	15B.	—	9.00	16.60	12.30	14.30	ESPE	—	9.53	23.81	4.76	—	14C
11497	8.00	17.00	6.00	—	15BB	20461	9.00	17.00	4.50	—	15BA	13605	9.53	25.04	6.35	—	15BA
—	8.00	17.00	7.00	—	12BB	20462	9.00	18.00	6.00	—	15BB	20471	9.53	25.40	6.35	—	15BB
—	8.00	17.45	8.00	—	15BA	20463	9.00	18.00	7.00	—	15BB	15545	9.53	25.40	7.94	—	ESPE
—	8.00	18.00	4.50	—	14BB	16904	9.00	19.00	5.00	—	15BA	20472	9.53	25.40	7.94	—	15BB
12661	8.00	18.00	5.00	—	12BB	11919	9.00	19.00	7.00	—	15BA	15545	9.53	25.40	7.94	—	1551
14100	8.00	18.00	5.00	—	15BB	13555	9.00	19.00	8.00	—	15BB	15233	9.53	25.40	9.52	—	15BB
12661	8.00	18.00	5.00	—	12BB	13555	9.00	19.00	8.00	—	15BB	15233	9.53	25.40	9.52	—	15B.
14100	8.00	18.00	5.00	—	15BB	14866	9.00	20.00	5.00	—	15BB	15233	9.53	25.40	9.52	—	15C
11322	8.00	18.00	6.35	—	15BB	—	9.00	22.00	7.00	—	12BB	15233	9.53	25.50	9.50	—	15B.
—	8.00	18.00	7.00	—	12BB	13483	9.00	22.00	7.00	—	15BA	20473	9.53	28.58	7.94	—	15BB
20450	8.00	18.00	7.00	—	15BB	13483	9.00	22.00	7.00	—	15BB	18369	9.53	28.58	9.52	—	15BA
14102	8.00	18.00	7.00	—	15BA	13483	9.00	22.00	7.00	—	15BA	17009	9.53	31.75	9.52	—	15BB
14102	8.00	18.00	7.00	—	15B.	14107	9.00	22.00	8.00	—	15B.	14664	9.53	31.75	9.52	—	12BB
13075	8.00	18.50	5.00	—	15BB	—	9.00	22.00	10.00	—	12BB	15291	9.53	33.34	7.94	—	F
—	8.00	19.00	5.00	—	14BB	20150	9.00	22.34	6.40	—	14BA	20473	9.53	34.93	9.53	—	15BB
—	8.00	19.00	7.00	—	12BB	13208	9.00	23.00	3.00	7.00	ESPE	—	9.53	38.10	6.35	—	14BA
11840	8.00	19.50	7.00	—	15BB	—	9.00	24.00	7.00	—	12BB	20474	9.53	38.10	9.53	—	15BB
20451	8.00	20.00	5.00	—	15BB	12517	9.00	24.00	7.00	—	15BB	14037	9.53	38.89	4.76	—	14BB
13076	8.00	20.00	6.00	8.00	12BB	20464	9.00	24.00	7.00	—	15BA	—	9.80	15.00	3.00	—	14BA
13076	8.00	20.00	6.00	8.00	12BB	20153	9.00	25.00	7.00	—	15BB	12330	9.90	15.00	10.00	14.00	15BA
—	8.00	20.00	7.00	—	12BB	—	9.00	26.00	7.00	—	12BB	20475	9.92	19.45	7.45	—	15B.
20453	8.00	20.00	8.00	—	15BB	20465	9.00	26.00	7.00	—	15BB	20476	9.92	19.84	4.76	—	15BB
20452	8.00	20.00	8.00	—	12BB	—	9.00	30.00	7.00	—	12BB	20478	9.92	26.59	9.53	—	15BB
20454	8.00	22.00	6.00	—	15BB	16561	9.00	30.00	7.00	—	15BA	20477	9.92	26.59	9.53	—	15B.
12894	8.00	22.00	6.00	8.00	12BB	—	9.30	26.00	11.00	—	12BB	12121	10.00	14.00	3.00	—	14BA
—	8.00	22.00	7.00	—	12BB	11786	9.40	21.40	5.00	—	14BA	12121	10.00	14.00	3.00	—	14BA
20455	8.00	22.00	7.00	—	15BB	11901	9.50	14.30	12.30	14.30	ESPE	13059	10.00	15.00	3.00	—	14BB
20456	8.00	22.00	8.00	—	15BB	11740	9.50	16.00	7.00	—	15BB	13059	10.00	15.00	3.00	—	14BA
20456	8.00	22.00	8.00	—	15BA	13063	9.50	18.50	6.30	—	14BB	—	10.00	16.00	4.00	—	12BB
14104	8.00	22.00	8.00	—	15B.	15583	9.50	19.05	7.00	—	15BB	12080	10.00	16.00	4.00	—	14BA
—	8.00	24.00	7.00	—	12BB	20107	9.50	19.05	7.14	—	15BB	12080	10.00	16.00	4.00	—	14BA
20457	8.00	24.00	7.00	—	15BB	13077	9.50	20.00	7.50	—	14BB	12080	10.00	16.00	4.00	—	14BA
—	8.00	25.00	7.00	—	12BB	16104	9.50	28.50	7.90	—	15C	20480	10.00	16.00	4.00	—	15BB
16081	8.00	25.00	10.00	—	15BA	—	9.52	19.05	5.55	—	15BB	—	10.00	16.00	5.00	—	12BB
16081	8.00	25.00	10.00	—	15BA	17415	9.52	21.33	7.94	—	15BA	—	10.00	16.00	5.00	—	14BA
20458	8.00	28.00	7.00	—	15BA	20149	9.52	22.23	7.94	—	15B.	12122	10.00	17.00	3.00	—	14BA
20459	8.00	30.00	10.00	—	15BB	—	9.52	25.37	9.52	—	14BB	11047	10.00	17.00	4.00	—	14BB
20387	8.00	32.00	15.00	—	TDUO	15545	9.52	25.40	7.93	—	ESPE	—	10.00	17.00	5.00	—	14BB
25408	8.00	32.00	19.00	—	TDUO	—	9.53	14.29	2.38	—	14BA	20143	10.00	17.00	5.00	—	14BA
25408	8.00	32.00	19.00	—	TDUO	—	9.53	14.29	2.90	—	14BA	20143	10.00	17.00	5.00	—	14BA
25408	8.00	32.00	19.00	—	TDUO	12488	9.53	14.29	3.17	—	14BA	—	10.00	18.00	5.00	—	12BB
—	8.00	35.00	13.00	—	ESPE	15320	9.53	14.29	6.35	—	F	12969	10.00	18.00	5.00	—	15BB



# Retentores

Perfis - Ver Última Página



INCOVE VEDAÇÕES LTDA.

Cod.	Di	De	Ha1	Ha2	Mod	Cod.	Di	De	Ha1	Ha2	Mod	Cod.	Di	De	Ha1	Ha2	Mod
12099	10.00	18.00	6.00	—	I5BB	16523	10.00	32.00	5.00	—	I5BB	—	11.10	22.20	6.50	—	I2BB
12099	10.00	18.00	6.00	—	I5BA	20497	10.00	32.00	5.00	—	I5BA	18954	11.11	15.88	3.17	—	I4BA
—	10.00	18.00	7.00	—	I2BB	11889	10.00	32.00	19.00	—	TDUO	16291	11.11	15.88	3.97	—	I4BA
20482	10.00	18.00	8.00	—	I5BB	11889	10.00	32.00	19.00	—	TDUO	12541	11.11	19.05	3.97	—	I5BB
20483	10.00	18.00	8.00	—	I5BA	11889	10.00	32.00	19.00	—	TDUO	—	11.11	19.05	6.35	—	I4BA
14803	10.00	18.00	8.00	—	I5B.	—	10.00	34.00	4.00	—	I4BA	18955	11.11	19.05	6.35	—	I5BB
20144	10.00	19.00	6.30	—	I5BB	14037	10.00	34.00	4.00	—	ESP	18209	11.11	20.64	6.35	—	I5BB
—	10.00	19.00	6.50	—	I5BB	20498	10.00	35.00	8.00	—	I5B.	18209	11.11	20.64	6.35	—	I5B.
20144	10.00	19.00	6.50	—	I5BB	20499	10.00	35.00	10.00	—	I2BB	20510	11.11	20.64	7.94	—	I5BA
20144	10.00	19.00	6.50	—	I5B.	16728	10.00	40.00	6.50	—	I5BB	18256	11.11	21.46	4.76	—	I4BA
13980	10.00	19.00	7.00	—	I5BB	11733	10.00	40.00	18.00	—	TDUO	18256	11.11	21.46	4.76	—	I5BA
13980	10.00	19.00	7.00	—	I5BA	25349	10.00	45.00	25.00	—	TDUO	20511	11.11	22.23	5.56	—	I5BB
20484	10.00	19.00	7.00	—	I2BB	25466	10.00	46.00	14.00	—	TDUO	18376	11.11	22.23	7.94	—	I5BA
13980	10.00	19.00	7.00	—	I5BB	20036	10.00	50.00	18.00	—	TDUO	18376	11.11	22.23	7.94	—	I5BB
20146	10.00	19.00	10.00	—	I5B.	20036	10.00	50.00	18.00	—	TDUO	18376	11.11	22.23	7.94	—	I5BA
20146	10.00	19.50	2.50	—	ESPE	16533	10.00	55.00	25.00	—	TDUO	20512	11.11	22.23	7.94	—	I5B.
.....	10.00	19.50	2.50	—	ESPE	22583	10.00	63.00	20.00	—	TDUO	18894	11.11	22.23	11.11	—	I2BA
—	10.00	20.00	5.00	—	I2BB	16440	10.00	67.00	25.00	—	TDUO	—	11.11	22.62	4.76	—	I4BA
12187	10.00	20.00	5.00	—	I5BB	—	10.32	15.08	3.18	—	I4BA	17754	11.11	22.62	4.76	—	I5B.
—	10.00	20.00	6.00	—	I5BB	—	10.32	17.46	3.97	—	I4BA	17290	11.11	23.02	6.35	—	I5BA
—	10.00	20.00	6.00	—	I2BB	—	10.32	21.83	6.35	—	I4BA	12932	11.11	25.40	5.16	—	I5BB
—	10.00	20.00	7.00	—	I2BB	18372	10.32	25.40	4.76	—	I4BB	18377	11.11	25.40	6.35	—	I5BB
—	10.00	20.00	7.50	—	I4BB	17646	10.32	25.40	9.52	—	I5BB	18377	11.11	25.40	6.35	—	I5BB
16059	10.00	20.00	7.50	—	I5BB	18371	10.32	25.40	12.70	—	I5BA	20067	11.11	25.40	8.73	—	I5B.
—	10.00	21.00	5.00	—	I5BB	18373	10.32	28.58	9.53	—	I5BB	15665	11.11	25.40	9.52	—	I5B.
—	10.00	21.00	7.00	—	I2BB	20501	10.32	28.58	9.53	—	I5BA	15665	11.11	25.40	9.52	—	I5BB
—	10.00	22.00	5.00	—	I2BB	18374	10.32	31.75	9.53	—	I5BB	14551	11.11	25.40	9.52	—	I2BB
20485	10.00	22.00	5.00	—	I5BB	F1305	10.50	18.00	1.50	—	I5BB	15665	11.11	25.40	9.52	—	I5C
13650	10.00	22.00	6.00	—	I4BA	22470	10.50	24.30	8.00	—	I2BB	15665	11.11	25.40	9.53	—	I5BA
14103	10.00	22.00	6.00	—	I5BB	18375	10.72	22.23	7.94	—	I5BB	20514	11.11	25.40	9.53	—	I5B.
12226	10.00	22.00	7.00	—	I5BB	—	10.80	20.00	9.00	—	I2BB	17768	11.11	25.40	12.70	—	I5BB
12226	10.00	22.00	7.00	—	I5BB	12762	10.85	22.42	5.36	—	I5BB	—	11.11	26.99	14.29	—	I1FB
12226	10.00	22.00	7.00	—	I5BB	13167	11.00	17.00	4.00	—	I5BA	14018	11.11	26.99	14.29	—	I1BF
20479	10.00	22.00	7.00	—	I5BA	—	11.00	17.00	4.00	—	I2BB	—	11.11	28.58	6.35	—	I4BA
12226	10.00	22.00	7.00	—	I5BB	13167	11.00	17.00	4.00	—	I5BB	18956	11.11	28.58	6.35	—	I4B.
11303	10.00	22.00	7.00	9.00	I2BB	—	11.00	17.00	4.00	—	I5BB	20515	11.11	28.58	6.35	—	I5BA
14105	10.00	22.00	8.00	—	I5BB	20502	11.00	17.00	4.00	—	I5BA	17362	11.11	28.58	9.52	—	I5B.
14105	10.00	22.00	8.00	—	I5BA	—	11.00	18.00	5.00	—	I4BB	17913	11.11	28.58	12.70	—	ESP.
14105	10.00	22.00	8.00	—	I5B.	—	11.00	19.00	3.00	—	I4BB	20516	11.11	28.58	—	—	I5BB
20486	10.00	22.00	8.00	—	I2BB	20503	11.00	19.00	5.00	—	I5BB	20517	11.11	31.50	9.53	—	I5BB
20487	10.00	23.00	6.00	—	I5BB	—	11.00	20.00	5.50	—	I4BB	20518	11.11	31.75	6.35	—	I5BB
14106	10.00	23.00	8.00	—	I5B.	20380	11.00	20.50	8.00	—	I5BB	18957	11.11	31.75	6.35	—	I5B.
—	10.00	24.00	7.00	—	I2BB	—	11.00	21.00	7.00	—	I2BA	18984	11.11	31.75	9.52	—	I2BB
20488	10.00	24.00	7.00	—	I5BA	—	11.00	22.00	7.00	—	I2BB	18380	11.11	31.75	9.52	—	I5B.
12663	10.00	24.30	5.50	—	ESPE	11681	11.00	22.00	7.00	—	I5BB	—	11.11	34.93	7.94	—	I4BA
12968	10.00	25.00	5.00	—	I5BB	20505	11.00	22.00	8.00	—	I5BB	19024	11.11	34.93	7.94	—	I5BB
—	10.00	25.00	7.00	—	I2BB	20128	11.00	22.00	8.00	—	I9BA	20519	11.11	44.45	15.88	—	I5BA
20489	10.00	25.00	7.00	—	I5BB	16056	11.00	22.00	10.00	—	I5BB	16261	11.14	25.96	9.53	—	I5BB
20490	10.00	26.00	7.00	—	I5BA	17290	11.00	23.00	7.00	—	I5B.	16839	11.50	20.00	7.00	—	I7BB
11785	10.00	26.00	7.00	—	I5BB	20506	11.00	23.00	7.00	—	I5BB	—	11.50	24.00	10.00	—	I2BB
—	10.00	26.00	8.00	—	I2BB	17290	11.00	23.00	7.00	—	I5BA	—	11.91	22.23	3.76	—	I4BA
14695	10.00	26.00	8.00	—	I5BB	16649	11.00	24.00	7.00	—	I5BB	—	11.91	22.23	5.75	—	I4BA
14695	10.00	26.00	8.00	—	I5BB	20507	11.00	25.00	7.00	—	I5BB	12840	11.91	22.23	6.35	—	I5BB
14695	10.00	26.00	8.00	—	I5BA	12576	11.00	25.60	6.30	—	I5BA	20520	11.91	22.23	6.35	—	I5BA
20491	10.00	26.00	8.00	—	I5B.	—	11.00	26.00	7.00	—	I2BB	20521	11.91	22.23	7.14	—	I2BA
18276	10.00	27.00	5.00	—	I5B.	20508	11.00	26.00	7.00	—	I5BB	18378	11.91	22.23	7.94	—	I5BB
18214	10.00	28.00	6.00	—	I13	14110	11.00	26.00	7.00	—	I5B.	20522	11.91	25.40	6.35	—	I5B.
11672	10.00	28.00	7.00	—	I5BB	13761	11.00	30.00	6.00	—	F	18379	11.91	25.40	9.52	—	I5B.
20494	10.00	28.00	8.00	—	I5BB	13761	11.00	30.00	6.00	—	I5BB	20523	11.91	25.40	9.53	—	I5BB
20495	10.00	28.50	10.00	—	I5BA	—	11.00	30.00	7.00	—	I2BB	20524	11.91	28.50	9.53	—	I5B.
—	10.00	30.00	7.00	—	I2BB	14111	11.00	30.00	10.00	—	I5BB	—	11.91	28.58	7.94	—	I5C
14108	10.00	30.00	7.00	—	I5BA	11686	11.00	30.00	10.00	—	I2BB	18381	11.91	34.93	10.32	—	I5BB
20154	10.00	30.00	7.00	—	I5BB	14111	11.00	30.00	10.00	—	I5BB	12123	12.00	16.00	3.00	—	I4BB
20154	10.00	30.00	7.00	—	I5BA	14112	11.00	30.00	12.00	—	I3B.	12123	12.00	16.00	3.00	—	I4BA
20496	10.00	30.00	10.00	—	I5BB	20509	11.00	30.00	12.00	—	I2BB	—	12.00	17.00	3.50	—	I4BB
25463	10.00	30.00	12.70	—	TDUO	—	11.00	35.00	7.00	—	I2BB	—	12.00	17.00	5.00	—	I2BB
16471	10.00	32.00	2.50	8.50	ESPE	11348	11.00	35.00	10.00	—	I5JM	12124	12.00	18.00	3.00	—	I4BB



# Retentores

Perfis - Ver Última Página



INCOVE VEDAÇÕES LTDA.

Cod.	Di	De	Ha1	Ha2	Mod	Cod.	Di	De	Ha1	Ha2	Mod	Cod.	Di	De	Ha1	Ha2	Mod
12124	12.00	18.00	3.00	—	14BB	13723	12.00	28.00	7.00	—	15BA	20549	12.70	22.23	9.35	—	15BB
13855	12.00	18.00	4.00	—	15BB	16238	12.00	28.00	7.00	—	12BB	15268	12.70	22.23	9.52	—	15B.
20526	12.00	18.00	4.50	—	15BA	—	12.00	28.05	8.00	—	12BA	14049	12.70	23.02	6.35	—	14BA
—	12.00	18.00	6.00	—	15BA	18383	12.00	28.10	7.00	—	15BB	—	12.70	23.81	9.53	—	14BA
20527	12.00	18.00	6.00	—	15BA	18383	12.00	28.70	6.00	—	15BA	20550	12.70	23.81	9.53	—	15BB
—	12.00	18.10	3.70	—	14BB	—	12.00	30.00	5.00	—	14BA	—	12.70	23.81	11.11	—	13BC
12125	12.00	19.00	3.00	—	14BA	18275	12.00	30.00	5.00	—	15BB	17923	12.70	23.82	9.52	—	ESPE
—	12.00	19.00	4.50	—	14BB	20158	12.00	30.00	7.00	—	15BB	18311	12.70	23.82	9.52	—	15B.
11932	12.00	19.00	5.00	—	15BB	20158	12.00	30.00	7.00	—	15BB	20159	12.70	25.00	6.35	—	15BB
11235	12.00	19.00	6.00	—	14BA	20158	12.00	30.00	7.00	—	15BA	20551	12.70	25.00	6.35	—	15BA
—	12.00	19.00	7.00	—	12BB	—	12.00	30.00	8.00	—	12BB	—	12.70	25.40	4.76	—	14BA
11191	12.00	19.00	10.00	—	15BB	14086	12.00	30.00	8.00	12.00	15BB	11168	12.70	25.40	4.76	—	15BA
—	12.00	20.00	5.00	—	12BB	14086	12.00	30.00	8.00	—	15BB	13865	12.70	25.40	6.35	—	12BA
—	12.00	20.00	5.00	—	12BA	14116	12.00	30.00	10.00	—	15BB	13261	12.70	25.40	6.35	—	15BA
16030	12.00	20.00	5.00	—	15BB	14116	12.00	30.00	10.00	—	15BA	15078	12.70	25.40	6.35	—	14BA
20527	12.00	20.00	5.00	—	15BA	20539	12.00	30.00	10.00	—	15B.	15078	12.70	25.40	6.35	—	14BA
—	12.00	20.00	7.00	—	12BB	20540	12.00	30.00	12.00	—	15BB	13261	12.70	25.40	6.35	—	15BB
20528	12.00	20.00	7.00	—	15BA	14677	12.00	32.00	5.00	—	15BA	13261	12.70	25.40	6.35	—	15BA
—	12.00	20.00	8.00	—	12BB	—	12.00	32.00	7.00	—	12BB	20552	12.70	25.40	6.35	—	15B.
25420	12.00	20.50	4.00	—	15BB	14677	12.00	32.00	7.00	—	15BA	20553	12.70	25.40	6.35	—	12BB
12505	12.00	20.50	7.00	—	15BB	14677	12.00	32.00	7.00	—	15BB	11726	12.70	25.40	6.35	—	12BA
11627	12.00	21.00	4.00	—	15BB	14129	12.00	32.00	7.00	—	15BA	—	12.70	25.40	6.50	—	15BB
16665	12.00	21.00	4.80	—	15BB	13687	12.00	32.00	10.00	—	15BB	20554	12.70	25.40	6.75	—	15BB
—	12.00	21.00	7.00	—	15BB	16645	12.00	32.00	14.00	—	15BB	20555	12.70	25.40	7.14	—	15BB
22423	12.00	21.50	5.00	—	14BA	16236	12.00	35.00	5.00	—	15BB	20556	12.70	25.40	7.94	—	15BA
20529	12.00	22.00	4.00	—	15BB	—	12.00	35.00	7.00	—	12BB	15503	12.70	25.40	9.52	—	15BB
—	12.00	22.00	5.00	—	12BB	20541	12.00	35.00	8.00	—	15BB	15503	12.70	25.40	9.52	—	15B.
16061	12.00	22.00	5.00	—	14BA	20542	12.00	35.00	10.00	—	15BB	15503	12.70	25.40	9.52	—	15BB
16061	12.00	22.00	5.00	—	14BA	20543	12.00	35.00	15.00	—	15BB	15503	12.70	25.40	9.52	—	15BA
14113	12.00	22.00	5.00	—	15BB	—	12.00	36.00	7.00	—	12BB	20557	12.70	25.40	9.53	—	15BA
14113	12.00	22.00	5.00	—	15BA	16226	12.00	40.00	8.50	—	ESPE	20558	12.70	25.40	9.53	—	15B.
13050	12.00	22.00	5.00	—	12BB	12197	12.00	40.00	9.00	—	15BB	—	12.70	25.40	9.53	—	17B.
11243	12.00	22.00	6.00	—	12BB	—	12.30	32.00	7.85	—	12BB	—	12.70	25.40	9.53	—	15C
14085	12.00	22.00	7.00	—	15BA	—	12.50	20.00	5.00	—	15BB	20559	12.70	25.40	11.11	—	15B.
14085	12.00	22.00	7.00	—	15BB	—	12.50	25.53	5.78	—	15BB	18382	12.70	25.40	12.70	—	11BF
13050	12.00	22.00	7.00	—	12BA	—	12.50	28.60	9.00	—	ESPE	20560	12.70	25.70	6.35	—	15B.
14085	12.00	22.00	7.00	—	15BB	—	12.50	39.80	4.20	10.80	ESPE	13566	12.70	26.99	3.97	—	14BA
14085	12.00	22.00	7.00	—	15B.	16392	12.60	21.55	5.00	—	14BA	13577	12.70	26.99	6.35	—	12BB
13050	12.00	22.00	7.00	—	12BB	18248	12.70	15.88	12.70	—	F	15839	12.70	26.99	20.64	—	REPA
13050	12.00	22.00	7.00	—	12BA	13837	12.70	17.46	2.38	—	14BA	17469	12.70	27.78	9.52	—	15B.
13050	12.00	22.00	7.00	—	12BA	12574	12.70	17.46	3.17	—	14BA	11156	12.70	28.00	6.35	—	15BB
25442	12.00	22.00	7.00	—	17BB	18958	12.70	17.46	3.97	—	14BA	—	12.70	28.50	7.00	—	12BB
20532	12.00	22.00	8.00	—	15BA	18959	12.70	19.05	2.38	—	14BA	18383	12.70	28.55	6.50	—	15BA
20531	12.00	22.00	8.00	—	15B.	11089	12.70	19.05	3.17	—	14BA	—	12.70	28.55	9.52	—	15BB
11428	12.00	22.00	9.00	—	12BB	—	12.70	19.05	3.97	—	14BB	16266	12.70	28.57	6.35	—	15BB
20256	12.00	23.00	5.00	—	15BB	18028	12.70	19.05	9.52	—	14BA	18000	12.70	28.57	7.14	—	12B.
—	12.00	24.00	7.00	—	12BB	—	12.70	19.10	3.00	—	14BB	20561	12.70	28.58	6.35	—	15BA
14174	12.00	24.00	7.00	—	15BB	20544	12.70	19.45	7.14	—	15BB	11296	12.70	28.58	7.94	—	15B.
14174	12.00	24.00	7.00	—	15BA	20545	12.70	20.64	4.76	—	15BA	20562	12.70	28.58	8.33	—	15B.
16461	12.00	24.00	7.00	—	12BA	—	12.70	20.64	6.35	—	14BA	15266	12.70	28.58	9.52	—	15BB
20157	12.00	24.00	7.00	8.00	12BA	20546	12.70	20.64	6.35	—	15BB	15266	12.70	28.58	9.52	—	15B.
20157	12.00	24.00	7.00	—	12BA	16816	12.70	20.70	6.00	—	15BB	—	12.70	28.58	9.53	—	15C
20157	12.00	24.00	8.00	—	12BB	—	12.70	21.43	4.76	—	14BA	17724	12.70	28.58	12.70	—	ESPE
—	12.00	24.00	10.00	—	12BB	—	12.70	21.43	6.35	—	14BA	20563	12.70	28.58	12.70	—	15B.
13093	12.00	24.00	10.00	—	14BB	17482	12.70	21.43	6.35	—	14BA	17724	12.70	28.58	12.70	—	12B.
20534	12.00	24.00	10.00	—	15BB	16037	12.70	21.50	4.00	—	15BA	17914	12.70	28.58	12.70	—	ESPE
—	12.00	25.00	5.00	—	14BB	16150	12.70	22.20	9.50	—	15BB	17948	12.70	28.58	12.70	—	11BF
12818	12.00	25.00	5.00	—	15BB	18005	12.70	22.23	3.17	—	14BA	17948	12.70	28.58	12.70	—	11FC
—	12.00	25.00	7.00	—	12BB	—	12.70	22.23	3.57	—	14BA	20564	12.70	28.58	14.29	—	15BB
11220	12.00	25.00	8.00	—	15BB	—	12.70	22.23	6.35	—	14BA	17363	12.70	28.58	14.29	—	15B.
12932	12.00	25.40	5.00	—	15BB	17753	12.70	22.23	6.35	—	15BB	15747	12.70	28.58	15.87	—	REPA
—	12.00	25.40	8.00	—	12BB	22463	12.70	22.23	6.35	—	12BB	20565	12.70	29.37	9.53	—	15BB
—	12.00	26.00	8.00	—	12BB	14702	12.70	22.23	7.94	—	15BB	17508	12.70	30.16	19.05	—	REPA
20342	12.00	26.00	8.00	—	15BB	14702	12.70	22.23	7.94	—	15BA	18384	12.70	31.75	5.55	—	15B.
11763	12.00	26.00	10.00	—	15BA	20547	12.70	22.23	7.94	—	15BB	—	12.70	31.75	6.35	—	14BA
13723	12.00	28.00	7.00	—	15BB	14702	12.70	22.23	7.94	—	15BA	14677	12.70	31.75	7.00	—	15BB
13723	12.00	28.00	7.00	—	15BA	20548	12.70	22.23	7.94	—	15B.	14677	12.70	31.75	7.00	—	15B.







# Retentores

Perfis - Ver Última Página



INCOVE VEDAÇÕES LTDA.

Cod.	Di	De	Ha1	Ha2	Mod	Cod.	Di	De	Ha1	Ha2	Mod	Cod.	Di	De	Ha1	Ha2	Mod
17186	12.70	31.75	9.52	—	I2BB	14808	13.00	26.00	7.00	—	I2BB	17297	14.00	24.00	4.00	—	I4BB
17186	12.70	31.75	9.52	—	I5BA	20578	13.00	26.00	7.00	—	I5BB	13092	14.00	24.00	5.00	—	I4BB
18387	12.70	31.75	13.49	—	I2B.	13190	13.00	26.00	9.00	—	I2BB	13092	14.00	24.00	5.00	—	I4BB
15895	12.70	31.75	26.98	—	REPA	—	13.00	26.00	9.00	—	I4BB	11568	14.00	24.00	5.00	—	I5BB
20566	12.70	31.78	13.49	—	I2BB	20579	13.00	26.00	9.00	—	I2BB	—	14.00	24.00	5.50	—	I2BB
—	12.70	31.95	9.52	—	I5BB	—	13.00	26.05	9.00	—	I2BB	12660	14.00	24.00	6.00	—	I2BB
17186	12.70	32.15	9.50	—	I5BA	13190	13.00	26.20	9.00	—	I2BB	—	14.00	24.00	6.00	—	I4BA
15825	12.70	33.34	9.52	—	REPA	—	13.00	27.00	5.00	—	I4BB	12660	14.00	24.00	6.00	—	I2BB
15920	12.70	33.34	30.16	—	REPA	—	13.00	27.00	7.00	—	I2BB	20590	14.00	24.00	6.50	—	I5BA
18960	12.70	34.92	6.35	—	I4BA	—	13.00	27.00	7.00	—	I2BB	13737	14.00	24.00	6.80	—	I5BB
20160	12.70	34.92	9.00	—	ESPE	20580	13.00	28.00	7.50	—	I5BB	13082	14.00	24.00	7.00	—	I5BB
17374	12.70	34.92	9.52	—	I5BA	20580	13.00	28.00	7.00	—	I2BB	13082	14.00	24.00	7.00	—	I5BB
17374	12.70	34.92	9.52	—	I5BA	20581	13.00	28.00	8.00	—	I5B.	13082	14.00	24.00	7.00	—	I5BA
17374	12.70	34.92	9.52	—	I5BA	—	13.00	29.00	9.00	—	I2BB	13104	14.00	24.00	7.00	—	I2BA
—	12.70	34.92	9.52	—	I5BA	—	13.00	30.00	6.00	—	I2BB	20591	14.00	24.00	7.00	—	I5BA
12877	12.70	34.93	6.35	—	I4BA	14119	13.00	30.00	8.00	—	I5BB	13104	14.00	24.00	7.00	—	I2BB
20567	12.70	34.93	6.35	—	I5B.	13012	13.00	30.00	8.00	—	I2BB	20592	14.00	24.00	7.00	—	I2BA
20568	12.70	34.93	7.14	—	I5BB	14119	13.00	30.00	8.00	—	I5BB	—	14.00	24.05	8.50	—	I2BB
20160	12.70	34.93	9.00	—	I4BA	20582	13.00	30.00	8.00	—	I2BB	13861	14.00	25.00	5.00	—	I5BB
20569	12.70	34.93	11.11	—	I5B.	14116	13.00	30.00	10.00	—	I5BA	—	14.00	25.00	7.00	—	I2BB
15797	12.70	38.10	9.52	—	I5B.	—	13.00	30.00	13.00	—	I2BB	20593	14.00	25.00	7.00	—	I5BA
20570	12.70	38.10	9.53	—	I5BA	20583	13.00	30.00	18.00	—	I5BB	11530	14.00	26.00	6.00	—	I5BB
16286	12.70	38.10	21.00	—	TDUO	20584	13.00	32.00	7.00	—	I2BB	20594	14.00	26.00	7.00	—	I5BA
20572	12.70	38.15	9.53	—	I5BB	13067	13.00	35.00	7.00	—	I5BB	—	14.00	26.00	8.00	—	I2BB
20573	12.70	41.20	11.11	—	I5BB	14120	13.00	35.00	10.00	—	I5BB	13757	14.00	26.00	8.00	—	I5BB
19017	12.70	41.27	7.94	—	I5B.	16576	13.00	35.50	8.00	—	I4BA	16558	14.00	28.00	7.00	—	I2BB
18080	12.70	41.28	20.64	—	REPA	16783	13.05	31.85	7.92	—	I5C	16558	14.00	28.00	7.00	—	I2BB
13571	12.70	42.86	3.97	—	I4B.	20073	13.30	25.20	12.00	—	I5BB	20595	14.00	28.00	7.00	—	I5BB
13228	12.70	60.33	22.22	—	TDUO	—	13.40	25.30	9.52	—	I2BB	16349	14.00	28.00	7.00	—	I5BA
16049	12.70	88.90	19.05	—	TDUO	13771	13.49	25.40	7.20	—	I5BB	20596	14.00	28.00	7.00	—	I2BB
12072	12.70	146.10	13.49	—	I5C	17028	13.49	25.40	9.52	—	I5B.	20597	14.00	28.00	10.00	—	I2BB
16331	12.75	50.80	21.60	—	TDUO	17028	13.49	25.40	9.52	—	I5C	12637	14.00	28.60	8.00	—	I5BA
19168	12.80	171.50	14.29	—	I5B.	12588	13.49	28.58	6.35	—	I2BA	—	14.00	29.00	7.00	—	I2BB
12126	13.00	19.00	3.00	—	I4BA	20585	13.49	28.58	6.50	—	I5BB	17469	14.00	29.00	9.50	—	I5B.
20246	13.00	19.00	4.00	—	I2BA	15266	13.49	28.58	9.52	—	I5BB	—	14.00	30.00	7.00	—	I2BB
20574	13.00	20.00	4.00	—	I5BA	15266	13.49	28.58	9.52	—	I5B.	20598	14.00	30.00	7.00	—	I5BA
20163	13.00	20.00	5.00	—	I2BB	18385	13.49	30.16	4.76	—	I4BB	16262	14.00	30.00	7.00	—	I5BB
20163	13.00	20.00	5.00	—	I2BB	20586	13.49	31.16	4.76	—	I5BB	14087	14.00	30.00	10.00	—	I5BB
20575	13.00	21.00	5.00	—	I5BB	15797	13.49	38.10	4.76	—	I5BA	20599	14.00	30.00	10.00	—	I5B.
14844	13.00	21.00	6.00	—	I5BA	—	13.50	20.00	4.00	—	I2BA	20600	14.00	30.00	10.00	—	I2BB
14844	13.00	21.00	6.00	—	I5B.	—	13.50	28.50	7.00	—	I5BB	—	14.00	32.00	7.00	—	I2BB
12166	13.00	22.00	3.00	—	I4BB	16798	13.50	33.10	10.20	—	I5BB	20601	14.00	32.00	7.00	—	I5BA
—	13.00	22.00	5.00	—	I2BB	25425	14.00	18.00	3.00	—	I4BA	13669	14.00	32.00	9.00	—	I5BA
12864	13.00	22.00	5.00	—	I5BB	12127	14.00	20.00	3.00	—	I4BA	12216	14.00	32.00	10.00	—	I2BB
12864	13.00	22.00	5.00	—	I5BA	13597	14.00	20.00	3.00	—	I2BB	12216	14.00	32.00	10.00	—	I5BB
13988	13.00	22.00	8.00	—	I5BA	12266	14.00	20.00	3.50	—	I5BA	13596	14.00	33.00	8.00	—	I5BA
11494	13.00	22.50	5.50	—	I5BB	12266	14.00	20.00	3.50	—	I5BB	—	14.00	33.00	9.00	—	I4BA
12518	13.00	23.00	3.00	—	I4BA	—	14.00	20.00	5.00	—	I4BB	14619	14.00	33.00	9.00	—	I4B.
12518	13.00	23.00	3.00	—	I4BA	13078	14.00	20.00	5.00	—	I5BB	14122	14.00	35.00	6.00	—	I13
14117	13.00	23.00	6.00	—	I5BB	12128	14.00	22.00	3.00	—	I4BA	20602	14.00	35.00	7.00	—	I5BB
14117	13.00	23.00	6.00	—	I5BA	12261	14.00	22.00	3.90	—	I4BB	—	14.00	35.00	8.00	—	I5BB
14117	13.00	23.00	6.00	—	I5B.	12261	14.00	22.00	3.90	—	I4BB	—	14.00	35.00	10.00	—	I2BB
—	13.00	24.00	6.00	—	I4BA	—	14.00	22.00	4.00	—	I4BB	12892	14.00	40.00	8.00	10.50	I2BB
13109	13.00	24.00	7.00	—	I4BA	—	14.00	22.00	4.00	—	I4BB	16532	14.00	40.00	23.00	—	TDUO
14118	13.00	24.00	7.00	—	I13	12824	14.00	22.00	4.00	—	I2BB	11957	14.20	63.50	46.00	—	ESPE
12091	13.00	24.00	7.00	—	I5BB	12824	14.00	22.00	4.00	—	I5BB	—	14.25	23.80	7.00	—	I5BB
12038	13.00	24.00	9.50	—	I2BA	—	14.00	22.00	5.00	—	I4BB	—	14.25	24.00	7.00	—	I5BB
11474	13.00	25.00	5.00	—	I5BB	14121	14.00	22.00	5.00	—	I4BA	18961	14.29	19.05	3.15	—	I4BB
20576	13.00	25.00	6.50	—	I5B.	14121	14.00	22.00	5.00	—	I4BA	18249	14.29	19.05	3.17	—	F
20080	13.00	25.00	7.00	—	I2BB	14121	14.00	22.00	5.00	—	I4B.	18249	14.29	19.05	3.17	—	I4BB
20080	13.00	25.20	9.30	—	I5C	—	14.00	22.00	7.00	—	I2BB	15236	14.29	20.64	6.35	—	I4BA
20577	13.00	26.00	5.00	—	I5BB	20589	14.00	22.00	8.00	—	I2BB	14698	14.29	23.02	5.55	—	I4B.
—	13.00	26.00	7.00	—	I2BB	13905	14.00	22.40	4.00	—	I5BB	20603	14.29	24.21	7.14	—	I2BA
17297	14.00	23.90	6.00	—	I4BB	12029	14.00	23.00	4.00	—	I5BB	18388	14.29	25.40	6.35	—	I4BB
11568	14.00	24.00	4.00	—	I5BB	17297	14.00	23.90	6.00	—	I4BB	13448	14.29	25.40	6.35	—	I2BB
—	—	—	—	—	—	11568	14.00	24.00	4.00	—	I5BB	13448	14.29	25.40	6.35	—	I2BA



# Retentores

Perfis - Ver Última Página



INCOVE VEDAÇÕES LTDA.

Cod.	Di	De	Ha1	Ha2	Mod	Cod.	Di	De	Ha1	Ha2	Mod	Cod.	Di	De	Ha1	Ha2	Mod
20604	14.29	25.40	7.94	—	I5BA	11502	15.00	24.00	4.00	—	I4BB	12218	15.00	30.00	6.00	—	I2BA
17028	14.29	25.40	9.52	—	I5B.	11704	15.00	24.00	5.00	—	I5BB	14088	15.00	30.00	6.00	—	I13
17028	14.29	25.40	9.52	—	I5C	20616	15.00	24.00	5.00	—	I5BA	20626	15.00	30.00	6.00	—	I5BB
20605	14.29	26.99	3.97	—	I5BB	14123	15.00	24.00	7.00	—	I5BB	12218	15.00	30.00	6.00	—	I2BA
15977	14.29	26.99	3.97	—	I5BA	12223	15.00	24.00	7.00	—	I2BB	14127	15.00	30.00	7.00	—	I5BB
18128	14.29	26.99	17.46	—	I1FB	12223	15.00	24.00	7.00	—	I2BA	12205	15.00	30.00	7.00	—	I2BA
18390	14.29	28.58	4.76	—	I5B.	14123	15.00	24.00	7.00	—	I5BB	—	15.00	30.00	7.00	—	I4BA
—	14.29	28.58	5.16	—	I4B	14123	15.00	24.00	7.00	—	I5BB	12205	15.00	30.00	7.00	—	I2BB
19955	14.29	28.58	6.35	—	I5BB	14123	15.00	24.00	7.00	—	I5BA	12205	15.00	30.00	7.00	—	I2BA
19955	14.29	28.58	6.35	—	I5BB	14123	15.00	24.00	7.00	—	I5B.	14127	15.00	30.00	7.00	—	I5BA
20606	14.29	28.58	6.35	—	I5B.	12223	15.00	24.00	7.00	—	I2BB	13484	15.00	30.00	8.00	—	I5BA
13275	14.29	28.58	7.94	—	I5B.	12223	15.00	24.00	7.00	—	I2BA	17298	15.00	30.00	8.00	—	I80B
20607	14.29	28.58	7.94	—	I5BA	12223	15.00	24.00	7.00	—	I2BB	13484	15.00	30.00	8.00	—	I5B
20608	14.29	28.58	8.33	—	I2BA	11185	15.00	24.00	7.00	—	I7BA	20629	15.00	30.00	8.00	—	I2BB
20609	14.29	28.58	8.73	—	I5B.	—	15.00	24.00	7.00	—	I7BA	14128	15.00	30.00	10.00	—	I5BB
15635	14.29	28.58	9.52	—	I5B.	14123	15.00	24.00	7.00	—	I5BB	14128	15.00	30.00	10.00	—	I5B.
15635	14.29	28.58	9.52	—	I5B.	14123	15.00	24.00	7.00	—	I5C	20630	15.00	30.00	10.00	—	I5BA
15635	14.29	28.58	9.52	—	I5B.	12223	15.00	24.00	7.00	—	I2BB	13859	15.00	30.00	10.00	—	I2BB
13047	14.29	28.58	9.52	—	I2B.	12250	15.00	24.00	7.40	—	I5BA	11133	15.00	30.00	10.00	—	I12B
15635	14.29	28.58	9.52	—	I5C	12250	15.00	24.00	7.40	—	I5BA	—	15.00	31.00	2.50	—	I5BB
18389	14.29	28.58	12.70	—	I3BC	11876	15.00	25.00	4.00	—	I5BB	16170	15.00	31.80	6.50	—	I5BA
13032	14.29	28.58	13.49	—	I7B.	20618	15.00	25.00	5.00	—	I5BB	—	15.00	32.00	7.00	—	I2BB
15474	14.29	30.16	7.94	—	I5BB	RU15	15.00	25.00	5.00	—	I5BA	14129	15.00	32.00	7.00	—	I5BB
18391	14.29	31.75	6.35	—	I5BA	11114	15.00	25.00	5.00	—	I2BB	14129	15.00	32.00	7.00	—	I5BB
18391	14.29	31.75	6.35	—	I5BA	—	15.00	25.00	6.00	—	I5BB	20631	15.00	32.00	7.00	—	I5BA
17673	14.29	31.75	9.52	—	I5BA	—	15.00	25.00	6.00	—	I2BB	20632	15.00	32.00	8.00	—	I5BB
17673	14.29	31.75	9.52	—	I5BA	13738	15.00	25.00	6.70	—	I5BA	20633	15.00	32.00	10.00	—	I5BB
17673	14.29	31.75	9.52	—	I5B.	13738	15.00	25.00	6.70	—	I5BA	16578	15.00	33.30	10.00	—	I5BB
17673	14.29	31.75	9.52	—	I5C	11269	15.00	25.00	7.00	—	I5BB	16779	15.00	35.00	3.00	4.00	RASP
17381	14.29	31.75	15.87	—	I1FB	—	15.00	25.00	7.00	—	I2BB	22517	15.00	35.00	5.00	—	I5BB
15841	14.29	31.75	20.64	—	REPA	16768	15.00	25.00	7.00	—	I2BB	20634	15.00	35.00	6.00	—	I2BA
18080	14.29	31.75	20.64	—	REPA	11925	15.00	25.00	7.00	—	I5BB	14130	15.00	35.00	7.00	—	I5BB
18082	14.29	31.75	28.58	—	REPA	16421	15.00	25.00	8.10	19.00	ESPE	12240	15.00	35.00	7.00	—	I2BA
17156	14.29	33.34	19.05	—	REPA	20619	15.00	25.00	10.00	—	I5BB	14130	15.00	35.00	7.00	—	I5BB
20610	14.29	34.53	9.13	—	I5BA	—	15.00	25.50	7.00	—	I2BB	20635	15.00	35.00	7.00	—	I5BA
18962	14.29	34.92	6.35	—	I4BA	—	15.00	26.00	4.50	—	I4BA	12240	15.00	35.00	7.00	—	I2BB
20611	14.29	34.93	6.35	—	I5BB	—	15.00	26.00	5.00	—	I4BA	12240	15.00	35.00	7.00	—	I2BA
20612	14.29	34.93	9.13	—	I5B.	11984	15.00	26.00	6.00	—	I2BA	—	15.00	35.00	8.00	—	I5BB
18386	14.29	34.93	10.32	—	I5BA	11984	15.00	26.00	6.00	—	I2BA	14131	15.00	35.00	8.00	—	I5C
18386	14.29	34.93	10.32	—	I5B.	11905	15.00	26.00	7.00	—	I5BB	13485	15.00	35.00	8.00	—	I5BA
18123	14.29	36.51	23.81	—	REPA	20620	15.00	26.00	7.00	—	I5BA	13485	15.00	35.00	8.00	—	I5BA
19025	14.29	38.10	7.94	—	I5BB	16861	15.00	26.00	7.00	—	I2BB	14132	15.00	35.00	10.00	—	I5B
15872	14.29	38.10	17.46	—	REPA	14124	15.00	26.00	8.00	—	I5BA	25392	15.00	35.00	10.00	—	I2BB
20164	14.29	39.69	6.35	—	I2BB	14124	15.00	26.00	8.00	—	I5BA	12313	15.00	35.00	10.00	12.70	ESPE
20613	14.29	39.69	6.35	—	I2BA	20622	15.00	27.00	7.00	—	I5BB	12132	15.00	35.00	10.00	12.70	I4BA
15911	14.29	39.69	25.40	—	REPA	RU19	15.00	27.00	7.00	—	I5BA	13320	15.00	35.00	10.00	—	I2BB
19026	14.29	40.08	9.52	—	I5BB	16507	15.00	27.00	8.00	—	I5BA	14132	15.00	35.00	10.00	—	I5BB
20614	14.29	40.08	9.53	—	I5BA	—	15.00	27.00	14.00	2.00	ESPE	14132	15.00	35.00	10.00	—	I5BB
17682	14.29	46.83	6.35	—	I4BA	11812	15.00	28.00	3.00	—	I4BA	15478	15.00	35.00	10.00	—	I5BA
11874	14.30	24.15	7.00	—	I5BB	—	15.00	28.00	6.00	—	I2BB	14132	15.00	35.00	10.00	—	I5BB
—	14.30	39.55	6.30	—	I2BA	14125	15.00	28.00	7.00	—	I5BA	14132	15.00	35.00	10.00	—	I5BA
15226	14.30	139.70	28.58	—	ESPE	18061	15.00	28.00	7.00	—	I4BA	13175	15.00	35.00	10.00	—	I2BB
—	14.50	22.00	4.00	—	I4BB	20623	15.00	28.00	7.00	—	I5BB	14132	15.00	35.00	10.00	—	I5B.
—	14.50	22.80	5.00	—	I4BA	—	15.00	28.00	7.00	—	I7BA	13191	15.00	35.00	10.00	12.00	ESPE
12344	14.70	22.10	7.00	—	I800	20624	15.00	28.00	7.50	—	I2BB	—	15.00	35.00	16.00	—	I7B.
F1228	14.90	22.29	2.90	—	AUP	11021	15.00	28.00	8.00	—	I5BB	13192	15.00	35.00	16.00	—	I7BB
—	15.00	21.00	3.00	—	I4BB	20625	15.00	28.00	9.00	—	I5BB	—	15.00	35.00	—	—	I2BB
12129	15.00	21.00	3.00	—	I4BA	14126	15.00	28.00	10.00	—	I5BB	—	15.00	37.00	2.50	—	I4BB
11604	15.00	21.00	4.00	—	I2BA	14126	15.00	28.00	10.00	—	I5B.	20637	15.00	37.00	10.00	—	I5BA
13879	15.00	21.00	4.00	—	I4BB	12753	15.00	28.50	10.00	—	I2BA	—	15.00	38.00	7.00	—	I2BB
13879	15.00	21.00	4.00	—	I4BA	—	15.00	30.00	3.50	—	I13	20638	15.00	40.00	6.00	—	I5BB
11604	15.00	21.00	4.00	—	I2BA	14881	15.00	30.00	4.00	—	I4BB	13906	15.00	40.00	8.50	—	ESPE
11877	15.00	22.00	7.00	—	I5BB	14881	15.00	30.00	4.00	—	I4BB	20639	15.00	40.00	10.00	—	I5BB
20615	15.00	22.00	7.50	—	I5BB	16841	15.00	30.00	4.00	—	I5BB	20640	15.00	41.28	9.53	—	I5BA
22561	15.00	22.35	9.00	—	I5BA	—	15.00	30.00	4.50	—	I2BB	13222	15.00	42.00	8.00	—	I5BB
—	15.00	23.00	3.00	—	I4BB	13180	15.00	30.00	5.00	—	I4BA	20641	15.00	42.00	8.00	—	I5BB
12130	15.00	23.00	3.00	—	I4BA	—	15.00	30.00	5.00	—	I4BA	20643	15.00	42.00	10.00	—	I5BB



# Retentores

Perfis - Ver Última Página



INCOVE VEDAÇÕES LTDA.

Cod.	Di	De	Ha1	Ha2	Mod	Cod.	Di	De	Ha1	Ha2	Mod	Cod.	Di	De	Ha1	Ha2	Mod
16827	15.00	42.00	10.00	—	I5BA	20653	15.88	26.99	9.53	—	I5BA	17717	15.88	33.34	19.05	—	REPA
20642	15.00	42.00	10.00	—	I5B.	11224	15.88	28.58	3.17	—	I4BA	—	15.88	34.93	6.35	—	I4BB
20644	15.00	58.00	9.00	—	I2BB	17405	15.88	28.58	4.76	—	I5BB	15395	15.88	34.93	6.35	—	I5B.
20645	15.08	24.21	7.14	—	I5BB	17405	15.88	28.58	6.35	—	I5BB	25311	15.88	34.93	7.94	—	I5BA
20646	15.08	25.40	4.76	—	I5BB	17911	15.88	28.58	6.35	—	I2BA	—	15.88	34.93	8.33	—	I5C
18390	15.08	28.58	4.76	—	I5BB	14687	15.88	28.58	7.00	—	I5BB	15478	15.88	34.93	9.52	—	I5BA
—	15.08	28.58	6.35	—	I4BA	14687	15.88	28.58	7.00	—	I5BB	15478	15.88	34.93	9.52	—	I5BB
20647	15.08	28.58	7.94	—	I5B.	13282	15.88	28.58	7.94	—	I5BA	15478	15.88	34.93	9.52	—	I5B.
20649	15.08	28.58	9.53	—	I5BA	20654	15.88	28.58	7.94	—	I2BA	15478	15.88	34.93	9.52	—	I5BA
20648	15.08	28.58	9.53	—	I5B.	15059	15.88	28.58	7.94	—	I1FB	15478	15.88	34.93	9.52	—	I5B.
—	15.08	28.58	11.91	—	I7B.	—	15.88	28.58	9.13	—	I1FB	15478	15.88	34.93	9.52	—	I5C
19924	15.08	30.16	9.52	—	I55	15159	15.88	28.58	9.52	—	I5BB	17667	15.88	34.93	10.32	—	I13
12975	15.20	22.00	5.00	—	I5BB	19946	15.88	28.58	9.52	—	I7BB	—	15.88	34.93	10.32	—	I4BB
11440	15.40	28.70	3.50	—	I4BA	15159	15.88	28.58	9.52	—	I5B.	12623	15.88	34.93	15.87	—	I7BB
16953	15.40	31.70	6.40	—	I5BA	15159	15.88	28.58	9.52	—	I5BB	—	15.88	34.93	18.26	—	I7C
20651	15.50	24.00	11.50	—	I5BB	15159	15.88	28.58	9.52	—	I5B.	18051	15.88	34.93	19.05	—	I7B.
—	15.50	25.50	7.00	—	I2BB	11626	15.88	28.58	9.52	—	I2BB	18051	15.88	34.93	19.05	—	I7C
—	15.50	28.70	8.50	—	I5BB	15159	15.88	28.58	9.52	—	I5B	—	15.88	35.32	14.29	—	I3B
—	15.60	24.00	—	—	I2BB	20655	15.88	28.58	9.53	—	I2B.	15395	15.88	37.93	6.35	—	I5BA
12931	15.60	26.00	6.00	—	I5BB	—	15.88	28.58	9.53	—	I7B.	15478	15.88	37.93	9.52	—	I5BA
—	15.77	25.41	5.20	—	I5BB	20656	15.88	28.58	12.70	—	I5BB	20665	15.88	38.10	7.94	—	I5BA
20125	15.80	28.50	13.50	—	I2B.	14843	15.88	28.58	12.70	—	I2BC	17737	15.88	38.10	9.52	—	I5BB
20304	15.80	38.00	6.60	—	I5BB	17731	15.88	28.58	14.29	—	I2BB	17737	15.88	38.10	9.52	—	I5B.
—	15.87	25.42	3.17	—	I4BB	17286	15.88	28.58	15.87	—	ESPE	17737	15.88	38.10	9.52	—	I5C
20012	15.87	25.50	15.90	—	I4BA	17569	15.88	28.58	15.87	—	I1FB	15926	15.88	38.10	30.16	—	REPA
—	15.87	27.20	6.35	—	I4BB	17791	15.88	28.58	17.46	—	I7C	19042	15.88	39.69	2.38	—	ESPE
—	15.87	28.55	5.50	—	I5BB	—	15.88	28.58	18.26	—	I7C	18394	15.88	40.08	7.94	—	I13
—	15.87	28.55	9.52	—	I2BB	15937	15.88	28.58	20.64	—	REPA	20666	15.88	41.28	11.11	—	I5BB
17911	15.87	28.57	6.35	—	I4BA	20657	15.88	28.58	—	—	I5BB	18395	15.88	41.28	11.11	—	I5BA
17911	15.87	28.57	6.35	—	ESPE	—	15.88	30.16	4.50	—	I4BB	18132	15.88	41.28	19.05	—	REPA
—	15.87	31.75	9.52	—	I5BB	13180	15.88	30.16	4.76	—	I4BB	18204	15.88	42.86	9.52	—	I5B.
—	15.87	35.02	9.52	—	I5BB	—	15.88	30.16	4.76	—	I13	20667	15.88	42.86	9.53	—	I5BB
—	15.87	35.02	9.52	—	I4BB	13180	15.88	30.16	4.76	—	I4BA	17720	15.88	46.04	30.16	—	ESPE
—	15.87	38.07	9.52	—	I5BB	17915	15.88	30.16	4.76	—	I13	—	15.88	46.43	11.11	—	I5C
18963	15.88	20.64	2.38	—	I4BA	18392	15.88	30.16	6.35	—	I13	15890	15.88	50.80	9.52	—	I5B.
18964	15.88	22.23	2.38	—	I4BA	15060	15.88	30.16	6.35	—	I5BA	20668	15.88	50.80	9.53	—	I5BB
—	15.88	22.23	3.18	—	I4BA	20321	15.88	30.16	7.94	—	I5BB	11773	15.88	63.50	20.64	—	TDUO
S2335	15.88	22.23	4.37	—	I2BA	19362	15.88	30.16	7.94	—	I5B.	17837	15.88	79.38	15.87	—	I1FB
20652	15.88	22.23	4.76	—	I2BA	14682	15.88	30.16	9.52	—	I4B.	—	15.90	22.00	3.50	—	I4BA
12036	15.88	22.23	5.95	—	I4BA	14032	15.88	30.16	15.87	—	REPA	—	15.90	22.20	4.30	—	I2BA
14707	15.88	22.23	6.35	—	I2BA	15933	15.88	30.16	17.46	—	REPA	17297	15.90	23.80	4.80	—	I4BA
—	15.88	22.23	6.35	—	I4BA	20658	15.88	30.96	7.94	—	I5BB	13679	15.90	24.30	8.00	9.00	ESPE
RU04	15.88	22.23	6.35	—	I5BB	15431	15.88	30.96	11.90	—	I5BA	20669	15.90	26.00	7.00	—	I5BB
14707	15.88	22.23	6.35	—	I2BA	—	15.88	30.96	11.91	—	I4BA	—	16.00	22.00	3.00	—	I4BB
17909	15.88	22.23	7.14	—	I4BA	20659	15.88	30.96	11.91	—	I5BB	12131	16.00	22.00	3.00	—	I4BB
17175	15.88	23.81	4.76	—	I4BB	11937	15.88	31.75	5.16	—	I5BB	12131	16.00	22.00	3.00	—	I4BA
—	15.88	23.81	4.76	—	I4BA	—	15.88	31.75	6.35	—	I4BA	13702	16.00	22.00	4.00	—	I4BA
18116	15.88	23.81	6.35	—	I5BB	17631	15.88	31.75	6.35	—	I5B.	11002	16.00	22.00	5.80	—	I4BA
15057	15.88	25.40	3.17	—	I4BA	20660	15.88	31.75	7.14	—	I5BB	—	16.00	22.80	4.80	—	I4BB
15057	15.88	25.40	3.30	—	I4BA	13302	15.88	31.75	7.94	—	I5BB	14882	16.00	24.00	3.00	—	I4BA
13256	15.88	25.40	4.76	—	I5BB	13302	15.88	31.75	7.94	—	I5BB	14882	16.00	24.00	3.00	—	I4BA
—	15.88	25.40	4.76	—	I4BA	13302	15.88	31.75	7.94	—	I5BB	—	16.00	24.00	3.50	—	I4BB
13256	15.88	25.40	4.76	—	I5BB	13302	15.88	31.75	7.94	—	I5BA	—	16.00	24.00	4.00	—	I4BA
13256	15.88	25.40	4.76	—	I5BA	20661	15.88	31.75	7.94	—	I5B.	17297	16.00	24.00	4.00	—	I4BA
13363	15.88	25.40	6.35	—	I5BA	13302	15.88	31.75	7.94	—	I5BB	11048	16.00	24.00	4.00	—	I5BB
17114	15.88	25.40	6.35	—	I4BB	15267	15.88	31.75	9.52	—	I5B.	11048	16.00	24.00	4.00	—	I5BB
—	15.88	25.40	6.35	—	I4BA	15267	15.88	31.75	9.52	—	I5B.	—	16.00	24.00	5.00	—	I2BB
13363	15.88	25.40	6.35	—	I5BB	20662	15.88	31.75	12.70	—	I2BA	20671	16.00	24.00	5.00	—	I5BB
13363	15.88	25.40	6.35	—	I5BA	18393	15.88	31.75	13.49	—	I2B.	—	16.00	24.00	6.00	—	I2BB
13364	15.88	25.40	6.35	—	I2BA	18130	15.88	31.75	20.64	—	REPA	20672	16.00	24.00	6.00	—	I5BA
15887	15.88	25.40	9.52	—	I55	15925	15.88	31.75	38.10	—	REPA	S2176	16.00	24.00	6.00	—	I2BB
—	15.88	25.40	15.92	—	I7B.	20663	15.88	31.77	7.54	—	I5BB	—	16.00	24.00	7.00	—	I2BB
18115	15.88	25.40	28.58	—	I4BA	12776	15.88	33.34	4.76	—	I5BB	12615	16.00	24.00	7.00	—	I5BB
15057	15.88	25.50	3.30	—	I4BA	20664	15.88	33.34	6.35	—	I5BB	12615	16.00	24.00	7.00	—	I5BB
20012	15.88	25.50	15.90	—	I4BA	17431	15.88	33.34	11.11	—	I3B.	RU09	16.00	24.00	7.00	—	I4BB
11439	15.88	26.59	6.35	—	I5BB	17916	15.88	33.34	11.11	—	I2BA	—	16.00	24.00	7.00	—	I4BA
14907	15.88	26.99	5.95	—	I4BB	17916	15.88	33.34	11.11	—	ESPE	12615	16.00	24.00	7.00	—	I5BB



# Retentores

Perfis - Ver Última Página



INCOVE VEDAÇÕES LTDA.

Cod.	Di	De	Ha1	Ha2	Mod	Cod.	Di	De	Ha1	Ha2	Mod	Cod.	Di	De	Ha1	Ha2	Mod
20673	16.00	24.00	7.00	—	I5BA	14141	16.00	35.00	12.00	—	I8BB	14090	17.00	28.00	7.00	—	I2BA
12636	16.00	25.00	3.00	—	I4BA	14140	16.00	36.00	7.00	—	I5B.	—	17.00	28.00	7.00	—	I5BA
—	16.00	25.00	5.00	—	I2BB	—	16.00	40.00	8.00	—	I2BB	14145	17.00	28.00	7.00	—	I5BB
14133	16.00	25.00	5.00	—	I5BB	20688	16.00	40.00	10.00	—	I5BB	14145	17.00	28.00	7.00	—	I5BA
—	16.00	25.00	6.00	—	I2BB	14142	16.00	42.00	16.00	—	I2B.	11189	17.00	28.00	7.00	—	I7B.
—	16.00	25.00	7.00	—	I2BB	22587	16.00	50.00	25.00	—	TDUO	—	17.00	28.00	7.00	—	I7BA
—	16.00	26.00	5.00	—	I2BB	16533	16.00	55.00	25.00	—	TDUO	11759	17.00	28.00	8.00	—	I7B.
20337	16.00	26.00	7.50	10.00	I2BB	20100	16.00	72.00	24.00	—	TDUO	13165	17.00	28.00	8.00	—	I7BB
16921	16.00	26.00	8.00	—	I5BB	25373	16.00	80.00	23.50	—	TDUO	20698	17.00	28.00	8.00	—	I5BA
12342	16.00	26.00	9.00	20.00	ESPE	16998	16.00	100.00	26.20	—	TDUO	RU25	17.00	28.00	8.00	—	I2BB
20674	16.00	27.00	5.00	—	I5BB	20689	16.27	28.18	6.75	—	I5BA	—	17.00	28.00	8.00	—	I7BB
20675	16.00	28.00	3.00	—	I2BB	11115	16.40	23.90	7.00	—	I5BB	—	17.00	28.05	5.00	—	I5BB
14134	16.00	28.00	7.00	—	I5BA	20690	16.40	23.90	7.00	—	I5BA	—	17.00	28.50	6.00	—	I2BB
13230	16.00	28.00	7.00	—	I2BB	20401	16.50	23.00	3.00	—	I4BB	12622	17.00	28.50	6.00	—	I3BC
14134	16.00	28.00	7.00	—	I5BA	20691	16.50	26.00	7.00	—	I5BA	—	17.00	29.00	5.00	—	I2BB
14134	16.00	28.00	7.00	—	I5BB	25359	16.50	26.40	5.00	—	I5BB	20699	17.00	29.00	5.00	—	I5BB
14134	16.00	28.00	7.00	—	I5BA	16654	16.50	28.00	7.00	—	I5BA	16451	17.00	29.00	6.00	—	I5BB
13230	16.00	28.00	7.00	—	I2BB	12713	16.50	28.50	9.50	—	I5B.	13487	17.00	29.00	6.00	—	I5BA
13230	16.00	28.00	7.00	—	I2BA	—	16.50	30.00	7.00	—	I5BB	—	17.00	30.00	5.00	—	I2BB
13230	16.00	28.00	7.00	—	I2BA	20692	16.67	28.58	9.53	—	I5BA	—	17.00	30.00	5.00	—	I4BA
13085	16.00	28.00	8.00	—	I5BA	20693	16.67	34.93	10.32	—	I5BB	12722	17.00	30.00	5.00	—	I13
13085	16.00	28.00	8.00	—	I5JM	18081	16.67	36.51	19.05	—	REPA	12831	17.00	30.00	5.50	—	I5BB
13085	16.00	28.00	8.00	—	I5BA	18399	16.67	40.08	9.52	—	N TE	—	17.00	30.00	6.00	—	I5BB
20676	16.00	28.00	8.00	—	I2BB	20694	16.67	40.08	9.53	—	I5BB	12617	17.00	30.00	6.00	—	I2BA
14135	16.00	28.00	10.00	—	I5BB	18130	16.67	41.28	20.64	—	REPA	14147	17.00	30.00	7.00	—	I5BB
14136	16.00	29.00	3.00	—	I13	18400	16.67	50.40	7.94	—	I4BA	14147	17.00	30.00	7.00	—	I5BA
—	16.00	29.90	7.30	—	I2BB	22473	16.70	28.00	7.00	—	I5B.	12682	17.00	30.00	7.00	—	I2BB
12245	16.00	30.00	6.00	—	I2BA	—	17.00	22.00	4.00	—	I4BA	—	17.00	30.00	7.00	—	I4B
20677	16.00	30.00	6.00	—	I5BA	13983	17.00	22.80	2.20	—	NT	14147	17.00	30.00	7.00	—	I5BB
12245	16.00	30.00	6.00	—	I2BA	—	17.00	23.00	3.00	—	I4BB	12682	17.00	30.00	7.00	—	I2BB
12202	16.00	30.00	6.40	—	I5BA	12133	17.00	23.00	3.00	—	I4BA	14147	17.00	30.00	7.00	—	I5BB
12201	16.00	30.00	6.40	—	I5BA	—	17.00	23.00	4.00	—	I4BB	12682	17.00	30.00	7.00	—	I2BB
—	16.00	30.00	7.00	—	I2BB	13981	17.00	24.00	2.00	—	N TE	16138	17.00	30.00	8.00	—	I5BA
20678	16.00	30.00	7.00	—	I5BA	14143	17.00	24.00	7.00	—	I5B.	14148	17.00	30.00	10.00	—	I5BB
11123	16.00	30.00	7.00	—	I5BB	16693	17.00	24.00	8.00	—	I5BB	—	17.00	30.40	6.00	—	I2BB
14137	16.00	30.00	8.00	—	I5BB	20721	17.00	24.00	8.00	—	I5B.	14149	17.00	31.00	7.00	—	I5BA
14137	16.00	30.00	8.00	—	I5BB	—	17.00	25.00	3.00	—	I4BB	14149	17.00	31.00	7.00	—	I5BB
20679	16.00	30.00	9.50	—	I5BA	12134	17.00	25.00	3.00	—	I4BA	20704	17.00	31.00	7.50	—	I5BB
14138	16.00	30.00	10.00	—	I5BB	—	17.00	25.00	4.00	—	I4BB	20702	17.00	31.00	7.50	—	I5BA
14138	16.00	30.00	10.00	—	I5B.	12659	17.00	25.00	4.00	—	I5BB	20703	17.00	31.00	7.50	—	I5B.
14138	16.00	30.00	10.00	—	I5BB	—	17.00	25.00	4.00	—	I4BA	14734	17.00	31.00	10.00	—	I5BB
14138	16.00	30.00	10.00	—	I5B.	—	17.00	25.00	4.00	—	I2BB	20705	17.00	31.00	10.00	—	I2BB
20680	16.00	30.00	10.00	—	I2BB	12659	17.00	25.00	4.00	—	I5BB	—	17.00	32.00	3.60	—	I2BA
25464	16.00	30.00	12.70	—	TDUO	—	17.00	25.00	7.00	—	I2BB	—	17.00	32.00	5.00	—	I5BB
14089	16.00	31.00	7.00	—	I5JM	20695	17.00	26.00	6.00	—	I5BB	—	17.00	32.00	7.00	—	I2BB
14089	16.00	31.00	7.00	—	I5BA	16488	17.00	26.00	6.00	—	I2BB	14091	17.00	32.00	7.00	—	I5BB
15431	16.00	31.00	10.00	—	I5BA	14144	17.00	26.00	8.00	—	I5BB	14091	17.00	32.00	7.00	—	I5BB
14139	16.00	32.00	3.00	—	I4BA	14144	17.00	26.00	8.00	—	I5B.	14091	17.00	32.00	7.00	—	I5BB
20048	16.00	32.00	6.50	—	I2BB	—	17.00	27.00	2.00	—	I4BA	20706	17.00	32.00	7.00	—	I5BA
20048	16.00	32.00	6.50	—	I2BB	—	17.00	27.00	5.00	—	I2BB	20007	17.00	32.00	8.00	—	I5BB
—	16.00	32.00	7.00	—	I2BB	—	17.00	27.00	6.00	—	I2BB	—	17.00	32.00	9.00	—	I2BB
14150	16.00	32.00	7.00	—	I5BB	20313	17.00	27.00	6.00	—	I5BB	14888	17.00	32.00	10.00	—	I5BB
14150	16.00	32.00	7.00	—	I5BB	13224	17.00	28.00	4.00	7.00	ESPE	20707	17.00	32.00	10.00	—	I5B.
20682	16.00	32.00	7.00	—	I5BA	—	17.00	28.00	5.00	—	I2BB	12175	17.00	33.00	7.00	—	I5BA
20683	16.00	32.00	8.00	—	I5BB	RU03	17.00	28.00	5.00	—	I5BB	20708	17.00	33.00	9.00	—	I2BA
20684	16.00	32.00	10.00	—	I5B.	20697	17.00	28.00	5.00	—	I5BA	14151	17.00	33.00	9.00	—	I2B.
16984	16.00	32.00	10.00	—	I5BB	13141	17.00	28.00	6.00	—	I5BA	—	17.00	34.00	4.00	—	I2BB
16984	16.00	32.00	10.00	—	I5BB	13141	17.00	28.00	6.00	—	I5BB	14155	17.00	34.00	4.00	—	I5BA
20685	16.00	33.00	7.00	—	I5BB	13487	17.00	28.00	6.00	—	I5BB	14155	17.00	34.00	4.00	—	I5BA
14140	16.00	33.00	7.00	—	I5BA	13487	17.00	28.00	6.00	—	I5BB	12219	17.00	34.00	7.00	—	I2BA
13187	16.00	35.00	6.00	9.00	I2BB	13487	17.00	28.00	6.00	—	I5BA	20709	17.00	34.00	7.00	—	I5BB
—	16.00	35.00	7.00	—	I2BB	14090	17.00	28.00	7.00	—	I2BB	14152	17.00	34.00	7.00	—	I5BA
20686	16.00	35.00	7.00	—	I5BB	14090	17.00	28.00	7.00	—	I2BB	20710	17.00	34.00	7.00	—	I2BB
20687	16.00	35.00	10.00	—	I5BB	—	17.00	28.00	7.00	—	I2BB	—	17.00	35.00	5.00	—	I2BB
14141	16.00	35.00	12.00	—	I8BB	13810	17.00	28.00	7.00	13.30	ESPE	14153	17.00	35.00	5.00	—	I13
—	16.00	35.00	12.00	—	I8BB	13810	17.00	28.00	7.00	10.00	ESPE	11245	17.00	35.00	6.00	—	I5BB
—	16.00	35.00	12.00	—	I2BB	14145	17.00	28.00	7.00	—	I5BA	—	17.00	35.00	7.00	—	I2BB





# Retentores

Perfis - Ver Última Página



INCOVE VEDAÇÕES LTDA.

Cod.	Di	De	Ha1	Ha2	Mod	Cod.	Di	De	Ha1	Ha2	Mod	Cod.	Di	De	Ha1	Ha2	Mod
13488	17.00	35.00	7.00	—	I2BA	19997	17.46	30.16	4.76	—	I4BB	22480	18.00	27.00	7.00	—	I2BB
13488	17.00	35.00	7.00	—	I5BB	18397	17.46	31.75	6.35	—	I4BA	16686	18.00	28.00	4.00	—	I2BB
20711	17.00	35.00	7.00	—	I5BA	18120	17.46	31.75	6.35	—	I4B.	12857	18.00	28.00	5.00	—	I2BB
13488	17.00	35.00	7.00	—	I5BB	18396	17.46	31.75	6.35	—	I5B.	—	18.00	28.00	6.50	—	I2BB
—	17.00	35.00	8.00	—	I5BB	20726	17.46	31.75	9.52	—	I5B.	12048	18.00	28.00	7.00	—	I5BB
14154	17.00	35.00	8.00	—	I5BB	20727	17.46	31.75	9.53	—	I5BB	12048	18.00	28.00	7.00	—	I5BA
14154	17.00	35.00	8.00	—	I5BB	19015	17.46	31.75	9.53	—	I2BA	20734	18.00	28.00	7.00	—	I2BB
20712	17.00	35.00	8.00	—	I5BA	18002	17.46	31.75	11.91	—	I2B.	16786	18.00	28.50	7.00	—	I2BB
11716	17.00	35.00	9.50	—	I5BB	14729	17.46	34.93	25.40	—	REPA	16786	18.00	28.50	7.00	—	I2BB
—	17.00	35.00	10.00	—	I2BB	18398	17.46	34.93	3.96	—	I5BA	22584	18.00	30.00	5.00	—	I5BB
15541	17.00	35.00	10.00	—	I5BB	—	17.46	34.93	6.35	—	I4BB	12896	18.00	30.00	6.00	—	I5BB
14157	17.00	35.00	10.00	13.00	I2BB	—	17.46	34.93	6.35	—	I4BA	12896	18.00	30.00	6.00	—	I2BB
11716	17.00	35.00	10.00	—	I5BB	—	17.46	34.93	7.94	—	I4BA	11221	18.00	30.00	7.00	—	I2BB
11716	17.00	35.00	10.00	—	I5BB	15541	17.46	34.93	9.52	—	I5B.	11221	18.00	30.00	7.00	—	I2BB
14166	17.00	35.00	10.00	—	I5B.	15814	17.46	34.93	9.52	—	I5B.	14163	18.00	30.00	7.00	—	I5BA
20713	17.00	35.00	10.00	—	I2BB	15541	17.46	34.93	9.52	—	I5B.	11221	18.00	30.00	7.00	—	I2BB
20714	17.00	35.00	10.00	—	I2B.	15541	17.46	34.93	9.52	—	I5BA	14163	18.00	30.00	7.00	—	I5BA
11716	17.00	35.00	10.00	—	I5BB	15541	17.46	34.93	9.52	—	I5C	20735	18.00	30.00	7.00	—	I2BB
18180	17.00	35.30	7.00	—	I2BB	11923	17.46	34.93	9.52	—	I2B.	11210	18.00	30.00	9.00	—	I5BB
—	17.00	36.00	7.00	—	I2BB	—	17.46	34.93	9.53	—	I13	20736	18.00	30.00	13.00	—	I5BB
16891	17.00	36.00	7.00	—	I5BB	20728	17.46	34.93	9.53	—	I5BB	22444	18.00	31.30	7.50	—	I5BA
20715	17.00	37.00	7.00	—	I5BA	—	17.46	34.93	10.20	—	I5C	—	18.00	31.75	3.57	—	I4BA
16195	17.00	37.00	8.00	—	I5BB	20729	17.46	34.93	11.11	—	I5B.	—	18.00	32.00	7.00	—	I2BB
16195	17.00	37.00	8.00	—	I5BA	15794	17.46	34.93	17.46	—	REPA	RU09	18.00	32.00	7.00	—	I5BB
14158	17.00	37.00	10.00	—	I5BB	15940	17.46	36.51	19.05	—	REPA	20737	18.00	32.00	7.00	—	I5BA
20716	17.00	37.00	10.00	—	I5BA	18127	17.46	36.51	19.84	—	I1FB	20739	18.00	32.00	8.00	—	I5BB
—	17.00	38.00	7.00	—	I2BB	18087	17.46	38.10	6.35	—	I4BA	20738	18.00	32.00	8.00	—	I2BB
12053	17.00	39.00	6.80	—	I5BB	18402	17.46	38.10	9.52	—	I5BA	14164	18.00	32.00	8.50	—	I5BB
16669	17.00	40.00	5.00	—	I5BB	18402	17.46	38.10	9.52	—	I5C	20740	18.00	32.00	9.00	—	I5BB
—	17.00	40.00	6.00	—	I2BB	—	17.46	38.10	9.92	—	I5C	20741	18.00	33.00	8.00	—	I5BB
20717	17.00	40.00	6.00	—	I5BB	14861	17.46	38.10	17.05	—	REPA	14165	18.00	33.00	8.00	—	I5B.
12182	17.00	40.00	7.00	—	I5BB	15811	17.46	38.10	31.75	—	REPA	—	18.00	33.30	8.00	—	I2BA
20718	17.00	40.00	7.00	—	I5BA	18226	17.46	39.69	6.35	—	N TE	14812	18.00	34.00	4.00	—	I4BB
14159	17.00	40.00	8.00	—	I5BB	19028	17.46	40.08	7.94	—	N TE	—	18.00	35.00	7.00	—	I2BB
—	17.00	40.00	8.50	—	I5BB	20222	17.46	41.28	8.73	—	I5B.	20742	18.00	35.00	7.00	—	I5BB
—	17.00	40.00	8.50	—	I2BB	19027	17.46	41.28	9.52	—	I5B.	25310	18.00	35.00	8.00	—	I5BB
13127	17.00	40.00	8.50	—	I5BB	20730	17.46	41.28	9.53	—	I5BB	14166	18.00	35.00	8.00	—	I5B.
11470	17.00	40.00	8.50	—	I5BB	15820	17.46	41.28	17.46	—	REPA	14166	18.00	35.00	8.00	—	I5B.
—	17.00	40.00	10.00	—	I8BB	18129	17.46	41.28	20.64	—	REPA	14167	18.00	35.00	10.00	—	I5BB
14160	17.00	40.00	10.00	—	I5BB	16148	17.46	46.04	8.33	—	I2BB	20744	18.00	35.00	10.00	—	I5BB
14160	17.00	40.00	10.00	—	I5BA	13570	17.46	49.21	9.52	—	I5B.	20743	18.00	35.00	10.00	—	I2BA
20719	17.00	40.00	10.00	—	I5B.	—	17.50	25.00	4.00	—	I4BB	14167	18.00	35.00	10.00	—	I5B.
12617	17.00	40.00	11.00	—	I8BB	—	17.50	28.50	6.00	—	I5BB	14167	18.00	35.00	10.00	—	I5C
13166	17.00	40.00	11.00	—	I8BB	—	17.50	28.50	7.00	—	I2BB	20745	18.00	35.00	12.00	—	I5BB
20720	17.00	40.00	14.00	—	I2BB	12282	17.50	30.50	4.50	—	I4BB	12065	18.00	36.00	10.00	—	I5BB
—	17.00	42.00	7.00	—	I2BB	20731	17.50	34.00	4.00	—	I5BA	20746	18.00	37.00	7.00	—	I2BB
—	17.00	45.00	7.00	—	I2BB	—	17.50	35.00	7.00	—	I2BB	13068	18.00	37.00	7.00	—	I5BB
20087	17.00	47.00	7.00	—	I5BB	20167	17.50	35.15	11.01	—	I5B.	12662	18.00	37.00	8.00	—	I2BB
—	17.00	47.00	8.00	—	I2BB	20732	17.50	37.00	7.00	—	I5BA	12662	18.00	37.00	8.00	—	I2BB
14161	17.00	47.00	10.00	—	I5BB	—	17.70	25.00	6.00	—	I4BA	13741	18.00	38.00	10.00	—	I5BB
—	17.10	28.55	6.35	—	I4BA	—	17.80	32.15	5.50	—	I4BA	—	18.00	40.00	7.00	—	I2BB
13001	17.46	23.82	2.38	—	I4B.	12334	17.90	30.00	11.00	—	ESPE	16374	18.00	40.00	7.00	—	I5BB
—	17.46	25.40	3.18	—	I4BA	12314	18.00	22.00	20.00	—	I8B.	13164	18.00	40.00	9.00	—	I5BB
13178	17.46	25.40	3.80	5.80	I5BA	—	18.00	24.00	3.00	—	I4BA	13164	18.00	40.00	9.00	—	I5BB
—	17.46	27.02	7.30	—	I5BB	12135	18.00	24.00	3.00	—	I4BA	—	18.00	40.00	10.00	—	I2BB
20722	17.46	28.18	6.99	—	I5BA	13559	18.00	24.00	3.00	—	I2BB	—	18.00	40.00	10.00	—	I4BB
20723	17.46	28.46	7.12	—	I5BB	25390	18.00	24.00	4.00	—	I4BB	20747	18.00	40.00	10.00	—	I5BB
18401	17.46	28.58	3.17	—	I4BA	—	18.00	24.00	4.00	—	I4BB	20115	18.00	42.00	7.00	—	I5BB
—	17.46	28.58	6.35	—	I4BA	—	18.00	24.00	4.00	—	I4BB	16797	18.00	44.60	9.00	—	I5BB
13034	17.46	28.58	6.35	—	I5BB	11720	18.00	25.00	5.50	—	I5BB	14874	18.00	47.00	8.00	—	I5BB
13034	17.46	28.58	6.35	—	I5BA	12136	18.00	26.00	4.00	—	I4BA	14874	18.00	47.00	8.00	—	I5BB
14689	17.46	28.58	7.14	—	I5BB	—	18.00	26.00	4.50	—	I5BB	20253	18.00	47.00	10.00	—	I5BB
—	17.46	28.58	7.14	—	I7B.	—	18.00	26.00	7.00	—	I2BB	20054	18.00	50.00	10.00	—	I5BB
17147	17.46	28.58	9.52	—	I5JM	20733	18.00	26.00	7.00	—	I5BA	—	18.00	80.00	30.00	—	TDUO
17147	17.46	28.58	9.52	—	I5B.	11255	18.00	26.00	8.00	—	I5BB	—	18.20	30.00	6.00	—	I2BB
20725	17.46	28.58	9.53	—	I5BB	13634	18.00	27.00	5.00	—	I5BA	—	18.26	25.40	6.35	—	I4BA





# Retentores

Perfis - Ver Última Página



INCOVE VEDAÇÕES LTDA.

Cod.	Di	De	Ha1	Ha2	Mod	Cod.	Di	De	Ha1	Ha2	Mod	Cod.	Di	De	Ha1	Ha2	Mod
20749	18.26	26.99	4.76	—	I5BB	—	19.00	34.00	4.50	—	I4BB	17211	19.05	31.75	4.76	—	I5JM
20748	18.26	26.99	4.76	—	I5BA	12177	19.00	34.00	10.00	—	I5BB	11369	19.05	31.75	4.76	—	I5BA
—	18.26	28.58	4.76	—	I4BA	—	19.00	34.92	9.92	—	I5BB	13265	19.05	31.75	6.35	—	I5BB
20750	18.26	28.58	4.76	—	I5BA	17750	19.00	35.00	7.00	—	I5BB	13265	19.05	31.75	6.35	—	I5B.
17748	18.26	28.58	6.35	—	N TE	—	19.00	35.00	7.00	—	I2BB	—	19.05	31.75	6.35	—	I4BB
—	18.26	28.58	6.35	—	I4BA	17750	19.00	35.00	7.00	—	I5BB	15092	19.05	31.75	6.35	—	I4BA
17147	18.26	28.58	9.52	—	I5B.	17750	19.00	35.00	7.00	—	I5BA	—	19.05	31.75	6.35	—	I4B
15642	18.26	34.93	10.32	—	I5B.	—	19.00	35.00	8.00	—	I2BB	13265	19.05	31.75	6.35	—	I5BB
—	18.26	34.93	10.32	—	I5C	20760	19.00	35.00	9.00	—	I2BB	13265	19.05	31.75	6.35	—	I5BA
18082	18.26	34.93	17.46	—	REPA	12274	19.00	35.00	10.00	—	I5BA	16991	19.05	31.75	6.35	—	I2BA
12600	18.50	30.00	7.00	—	I5BA	12274	19.00	35.00	10.00	—	I5BB	13265	19.05	31.75	6.35	—	I5B.
16792	18.50	33.40	9.52	—	I5BA	20761	19.00	35.00	10.00	—	I5B.	15092	19.05	31.75	6.35	—	I4C
18180	18.70	34.90	8.70	9.00	I2B.	11005	19.00	35.00	12.00	—	I2BB	13382	19.05	31.75	7.94	—	I2BA
—	18.80	25.80	7.00	—	I4BB	RU02	19.00	35.90	7.00	—	I5BB	—	19.05	31.75	7.94	—	I4BA
16808	18.80	26.00	4.00	5.00	I4BA	20762	19.00	36.00	8.50	—	I5BB	13318	19.05	31.75	7.94	—	I5BB
—	18.80	27.00	4.76	—	I4BB	—	19.00	36.30	8.50	—	I5BB	20772	19.05	31.75	7.94	—	I5BA
—	18.80	31.70	11.00	—	I2BA	16901	19.00	37.00	6.00	—	I5BB	13382	19.05	31.75	7.94	—	I2BA
20751	18.80	31.75	11.11	—	I2BA	—	19.00	37.00	10.00	—	I5BA	13318	19.05	31.75	7.94	—	I5BA
20752	18.84	38.10	6.75	—	I5BA	—	19.00	38.00	7.00	—	I2BB	13318	19.05	31.75	7.94	—	I5C
—	19.00	25.37	3.16	—	I4BB	—	19.00	38.07	9.92	—	I5BB	17242	19.05	31.75	9.52	—	I2B.
—	19.00	26.19	10.40	—	I2BA	13140	19.00	39.00	7.00	5.00	I5BB	15444	19.05	31.75	9.52	—	I5BB
13102	19.00	26.80	6.00	—	ESPE	—	19.00	40.00	5.00	—	I4BA	15444	19.05	31.75	9.52	—	I5B.
12137	19.00	27.00	4.00	—	I4BA	20763	19.00	40.00	6.00	—	I5BB	15444	19.05	31.75	9.52	—	I5B.
—	19.00	27.00	5.00	—	I4BB	13830	19.00	40.00	6.35	—	I5BB	17242	19.05	31.75	9.52	—	I2B.
12000	19.00	27.00	5.50	—	I2BB	13830	19.00	40.00	6.35	—	I5BB	20773	19.05	31.75	9.53	—	I2BA
13572	19.00	27.00	6.00	—	I4BA	—	19.00	40.00	7.00	—	I2BB	13677	19.05	31.75	11.11	—	I5BA
20227	19.00	27.00	6.00	—	I5BB	20764	19.00	40.00	10.00	—	I5B.	11883	19.05	31.75	11.11	—	I2B.
11835	19.00	27.00	6.00	—	I5BB	20765	19.00	40.00	14.00	—	I5BB	19070	19.05	31.75	14.23	—	I7B.
—	19.00	28.58	6.74	—	I4BA	14278	19.00	40.00	14.00	—	I5B.	18331	19.05	31.75	15.08	—	I1BF
—	19.00	28.67	4.76	—	I5BA	—	19.00	40.24	6.35	—	I2BB	—	19.05	32.15	14.29	—	I7B.
—	19.00	28.67	5.50	—	I5BB	15580	19.00	41.30	11.00	—	I5BA	12483	19.05	32.54	6.35	—	I4BA
12277	19.00	29.00	6.40	—	I5BB	—	19.00	42.00	7.00	—	I2BB	20775	19.05	33.34	7.94	—	I2BA
13601	19.00	29.00	7.00	—	I5BB	20766	19.00	42.00	7.00	—	I5BB	18913	19.05	33.34	9.52	—	I5B.
13601	19.00	29.00	7.00	—	I5BB	—	19.00	45.00	7.00	—	I2BB	18913	19.05	33.34	9.52	—	I5BA
—	19.00	29.10	6.40	—	I5BB	20767	19.00	45.00	8.00	—	I5BB	20776	19.05	33.34	9.53	—	I5BB
—	19.00	30.00	3.20	—	I4BB	—	19.00	47.00	8.00	—	I2BB	11934	19.05	34.92	4.76	—	I5BA
—	19.00	30.00	5.50	—	I2BB	13554	19.00	47.00	10.00	—	I5B.	13312	19.05	34.92	6.35	—	I5BB
—	19.00	30.00	7.00	—	I2BB	13562	19.05	25.40	3.17	—	I4BA	15348	19.05	34.92	6.35	—	I5B.
12110	19.00	30.00	7.00	—	I4ES	13562	19.05	25.40	3.18	—	I4BB	17750	19.05	34.92	7.94	—	I5BB
20754	19.00	30.00	7.00	—	I5BB	13562	19.05	25.40	3.18	—	I4BA	17750	19.05	34.92	7.94	—	I5BA
13081	19.00	30.00	7.00	—	ESPE	17295	19.05	25.40	3.70	—	I4BA	17750	19.05	34.92	7.94	—	I5B.
14092	19.00	30.00	7.50	—	I5BA	18360	19.05	25.40	3.70	—	I4BA	15846	19.05	34.92	7.94	—	ESP
20755	19.00	30.00	7.60	—	I5BB	20363	19.05	25.40	3.97	—	I4BB	15485	19.05	34.92	10.30	—	I5B.
—	19.00	31.40	8.00	—	I2BB	—	19.05	25.40	3.97	—	I4BA	15485	19.05	34.92	10.32	—	I5BB
—	19.00	31.70	6.35	—	I5BB	14705	19.05	25.40	6.35	—	I4BA	15485	19.05	34.92	10.32	—	I5BB
—	19.00	31.73	9.52	—	I5BA	20768	19.05	26.99	4.76	—	I5BA	15485	19.05	34.92	10.32	—	I5B.
—	19.00	31.75	6.35	—	I5BB	14170	19.05	26.99	6.35	—	I4BA	15485	19.05	34.92	10.32	—	I5BA
—	19.00	31.75	7.90	—	I5BA	18403	19.05	27.38	4.76	—	I4BA	15485	19.05	34.92	10.32	—	I5C
—	19.00	31.75	9.52	—	I5BA	12949	19.05	27.38	4.76	—	I5BA	18404	19.05	34.92	12.70	—	I2B.
—	19.00	31.80	6.40	—	I5B.	17717	19.05	28.00	10.00	—	REPA	13203	19.05	34.92	12.70	—	I7B.
11913	19.00	31.80	7.70	—	I5BB	12251	19.05	28.58	3.97	—	I4BA	15106	19.05	34.92	19.05	—	I7BA
14164	19.00	31.90	7.00	—	I5BA	—	19.05	28.58	3.97	—	I4BA	15106	19.05	34.92	19.05	—	I7C
—	19.00	32.00	7.00	—	I2BB	13378	19.05	28.58	4.76	—	I5BA	—	19.05	34.93	6.35	—	I4BA
—	19.00	32.00	7.00	—	I2BB	13378	19.05	28.58	4.76	—	I5BA	20777	19.05	34.93	6.35	—	I2BA
15270	19.00	32.00	7.00	—	I5BB	13560	19.05	28.58	6.35	—	I2BA	—	19.05	34.93	7.94	—	I4BA
13231	19.00	32.00	7.00	—	I5BA	17221	19.05	28.58	6.35	—	I5BA	20778	19.05	34.93	7.94	—	I2BA
15270	19.00	32.00	7.00	—	I5BB	17221	19.05	28.58	6.35	—	I5B.	20779	19.05	34.93	8.73	—	I2B.
13231	19.00	32.00	7.00	—	I5BB	13560	19.05	28.58	6.35	—	I2BA	20781	19.05	34.93	9.53	—	I5BA
20757	19.00	32.00	7.00	—	I5BA	17221	19.05	28.65	6.35	—	I2BA	20780	19.05	34.93	9.53	—	I5B.
13231	19.00	32.00	7.00	—	I5BB	20770	19.05	29.00	6.35	—	I5BB	—	19.05	34.93	11.91	—	I7B.
20758	19.00	32.00	9.00	—	I5BB	20771	19.05	29.00	6.50	—	I5BB	20783	19.05	34.93	11.91	—	I2B.
22431	19.00	32.50	7.00	—	I5BB	11376	19.05	30.16	6.35	—	I5BA	—	19.05	34.93	12.70	—	I7B.
—	19.00	33.22	9.50	—	I2BB	12678	19.05	30.16	9.52	—	I5BA	—	19.05	34.93	18.26	—	I7C
—	19.00	33.30	7.80	—	I2BA	14464	19.05	31.75	3.17	—	I4BA	25355	19.05	35.00	6.50	—	I2BB
—	19.00	33.30	7.80	—	I2BB	—	19.05	31.75	3.57	—	I4BA	—	19.05	35.00	11.91	—	I1FB
22442	19.00	33.30	9.50	—	I5BB	—	19.05	31.75	4.76	—	I4BA	15515	19.05	35.72	13.49	—	I1BF
12580	19.00	33.70	7.90	—	I2BA	17211	19.05	31.75	4.76	—	I4B.	18205	19.05	35.72	25.40	—	REPA



# Retentores

Perfis - Ver Última Página



INCOVE VEDAÇÕES LTDA.

Cod.	Di	De	Ha1	Ha2	Mod	Cod.	Di	De	Ha1	Ha2	Mod	Cod.	Di	De	Ha1	Ha2	Mod
14669	19.05	36.51	8.73	—	I5BB	17725	19.84	38.10	9.92	—	I5BA	11004	20.00	32.00	7.00	—	I2BB
20784	19.05	36.51	9.53	—	I5BB	20807	19.84	38.10	9.92	—	I5B.	14176	20.00	32.00	7.00	—	I5BB
—	19.05	36.51	14.29	—	I13	—	19.84	38.10	18.26	—	I7B.	14176	20.00	32.00	7.00	—	I5BB
17027	19.05	37.31	19.05	—	REPA	17990	19.84	39.69	23.81	—	REPA	20815	20.00	32.00	7.00	—	I5BA
20785	19.05	38.01	9.92	—	I5BB	17010	19.84	41.28	11.11	—	I5BA	11244	20.00	32.00	7.00	—	I2BB
—	—	—	—	—	—	—	19.84	41.28	11.11	—	I5C	11004	20.00	32.00	7.00	8.00	I2BB
18965	19.05	38.10	6.35	—	I4BA	—	19.84	44.45	7.94	—	ESPE	14176	20.00	32.00	7.00	—	I5B.
20414	19.05	38.10	6.35	—	I5BA	14764	19.84	44.45	8.33	—	I5BB	—	20.00	32.00	8.00	—	I2BB
20786	19.05	38.10	6.35	—	I2BA	20808	19.84	26.00	4.00	—	I4BB	13447	20.00	32.00	8.00	—	I5BA
16510	19.05	38.10	7.94	—	I5BB	—	20.00	26.00	4.00	—	I4BB	16225	20.00	32.00	10.00	—	I5C
15568	19.05	38.10	9.52	—	I5B.	14884	20.00	26.00	4.00	—	I4BA	11370	20.00	33.00	5.00	—	I4BA
—	—	—	—	—	—	14884	20.00	26.00	4.00	—	I4BA	14177	20.00	33.00	10.00	—	I5BB
15568	19.05	38.10	9.52	—	I5C	13644	20.00	27.00	3.00	—	I4BA	—	20.00	33.00	10.00	—	I2BB
—	19.05	38.10	12.70	—	I7B.	25360	20.00	27.00	4.00	—	I4BA	14177	20.00	33.00	10.00	—	I5BB
18196	19.05	38.10	12.70	—	BOOT	—	20.00	27.40	4.00	—	I4BB	14177	20.00	33.00	10.00	—	I5B.
18405	19.05	38.10	15.87	—	I2B.	—	—	—	—	—	—	—	—	—	—	—	—
—	19.05	38.10	15.88	—	I1FB	12962	20.00	27.50	4.30	—	I4BA	12311	20.00	33.00	10.00	15.00	I7BB
20787	19.05	39.69	6.35	—	I5BB	11684	20.00	27.50	7.50	—	I5BB	—	20.00	33.33	7.93	—	I4BB
18406	19.05	39.69	9.52	—	N TE	—	20.00	28.00	4.00	—	I4BB	—	20.00	34.00	7.00	—	I2BB
20788	19.05	39.69	9.53	—	I5BB	12139	20.00	28.00	4.00	—	I4BA	14855	20.00	34.00	7.00	—	I5BB
18966	19.05	40.08	6.35	—	N TE	—	20.00	28.00	5.00	—	I4BA	14855	20.00	34.00	7.00	—	I5BB
—	—	—	—	—	—	—	20.00	28.00	6.00	—	I2BB	14855	20.00	34.00	7.00	—	I5BB
18407	19.05	41.28	6.35	—	N TE	13726	20.00	28.00	6.00	—	I4BA	20817	20.00	34.00	7.00	—	I5BB
20789	19.05	41.28	6.35	—	I5BB	11886	20.00	28.00	6.00	—	I5BB	—	20.00	34.75	12.70	—	I2BA
18252	19.05	41.28	7.94	—	I5BA	13655	20.00	28.00	7.00	—	I5BA	12331	20.00	34.80	3.00	10.00	I2BB
20790	19.05	41.28	7.94	—	I5BA	16065	20.00	30.00	3.50	—	I4BA	—	20.00	34.85	3.00	10.70	I2BB
20791	19.05	41.28	7.94	—	I5B.	—	—	—	—	—	—	—	—	—	—	—	—
—	—	—	—	—	—	13209	20.00	30.00	4.00	17.00	I7B.	14461	20.00	35.00	4.00	—	I5BB
18252	19.05	41.28	7.94	—	I5BA	20809	20.00	30.00	4.50	—	I5BB	—	20.00	35.00	4.00	—	I4BB
15580	19.05	41.28	11.11	—	I5C	12044	20.00	30.00	5.00	—	I5BB	14461	20.00	35.00	4.00	—	I5BB
15580	19.05	41.28	11.11	—	I5BB	14171	20.00	30.00	6.00	—	I5JM	13240	20.00	35.00	4.50	—	I4BA
20792	19.05	41.28	11.11	—	I5BA	14171	20.00	30.00	7.00	—	I5JM	—	20.00	35.00	6.00	—	I5BA
—	—	—	—	—	—	14092	20.00	30.00	7.00	—	I5BB	—	20.00	35.00	6.00	—	I2BB
20793	19.05	41.28	11.11	—	I5B.	—	20.00	30.00	7.00	—	I5BB	14178	20.00	35.00	6.00	—	I5BA
20794	19.05	42.86	7.94	—	I5BB	13163	20.00	30.00	7.00	—	ESPE	—	20.00	35.00	6.00	—	I2BB
19364	19.05	42.86	7.94	—	I5B.	14092	20.00	30.00	7.00	—	I5BB	14178	20.00	35.00	6.00	—	I5BB
18967	19.05	44.45	6.35	—	I5BB	13593	20.00	30.00	7.00	—	I2BA	20819	20.00	35.00	6.00	—	I5BA
20795	19.05	44.45	6.35	—	I5BB	—	—	—	—	—	—	—	—	—	—	—	—
—	—	—	—	—	—	14092	20.00	30.00	7.00	—	I5BB	14178	20.00	35.00	6.00	—	I5B.
13417	19.05	44.45	7.94	—	I5BA	14092	20.00	30.00	7.00	—	I5BA	12243	20.00	35.00	7.00	—	I2BB
13417	19.05	44.45	7.94	—	I5BA	14092	20.00	30.00	7.00	—	I5B.	—	20.00	35.00	7.00	10.60	I5BB
17723	19.05	44.45	11.11	—	I5BA	13593	20.00	30.00	7.00	—	I2BB	12343	20.00	35.00	7.00	11.00	ESPE
17723	19.05	44.45	11.11	—	I5C	13593	20.00	30.00	7.00	—	I2BA	—	20.00	35.00	7.00	—	I5BB
—	—	—	—	—	—	14092	20.00	30.00	7.00	—	I5BB	12243	20.00	35.00	7.00	—	I2BB
20796	19.05	45.64	9.53	—	I5BB	14092	20.00	30.00	7.00	—	I5C	16713	20.00	35.00	7.00	—	I5BB
14786	19.05	46.04	27.00	—	REPA	—	20.00	30.00	9.00	—	I5C	20820	20.00	35.00	7.00	—	I5BB
14022	19.05	46.83	2.38	—	ESPE	25371	20.00	30.00	9.00	—	I5TG	12243	20.00	35.00	7.00	—	I2BB
17470	19.05	46.83	11.11	—	N TE	14173	20.00	30.00	10.00	—	I5BB	20821	20.00	35.00	7.00	—	I2BB
—	—	—	—	—	—	20811	20.00	30.00	10.00	—	I5BA	12243	20.00	35.00	7.00	—	I2BA
20797	19.05	46.83	11.11	—	I5BB	14173	20.00	30.00	10.00	—	I5B.	13163	20.00	35.00	7.00	—	I5BB
19958	19.05	46.83	12.70	—	I3BC	—	20.00	30.00	10.00	—	I7B.	16713	20.00	35.00	7.00	—	I5BB
12733	19.05	47.63	9.52	—	I5BA	14173	20.00	30.00	10.00	—	I5BB	20822	20.00	35.00	8.00	—	I5BA
20798	19.05	47.63	11.11	—	I5BB	17593	20.00	31.00	4.00	—	F	14878	20.00	35.00	8.00	—	I2BB
18408	19.05	47.63	11.11	—	I5B.	—	—	—	—	—	—	—	—	—	—	—	—
—	—	—	—	—	—	—	20.00	31.00	7.00	—	I5BA	14878	20.00	35.00	8.00	—	I5BB
19974	19.05	49.21	9.52	—	I5B.	—	20.00	31.00	7.00	—	I2BB	14878	20.00	35.00	8.00	—	I2BB
20799	19.05	49.21	9.53	—	I5BB	—	20.00	31.00	7.00	—	I5BA	20822	20.00	35.00	8.00	—	I5BA
20800	19.05	50.40	12.70	—	I5BB	—	20.00	31.00	7.00	—	I5BA	14878	20.00	35.00	8.00	—	I2BB
18409	19.05	50.40	12.70	—	I5B.	S2285	20.00	31.00	7.00	—	I5BA	22528	20.00	35.00	9.50	—	I5B.
18410	19.05	63.50	12.70	—	N TE	13162	20.00	31.30	7.60	—	I5BA	—	—	—	—	—	—
—	—	—	—	—	—	—	20.00	31.82	8.00	—	I2BA	12307	20.00	35.00	10.00	—	I2BB
20801	19.05	63.50	12.70	—	I5BB	—	—	—	—	—	—	20823	20.00	35.00	10.00	—	I5B
13994	19.10	38.20	8.00	—	I5BB	12305	20.00	32.00	3.00	10.70	I2BB	15056	20.00	35.00	10.00	—	I5BB
11808	19.10	49.10	10.00	—	I4BA	—	20.00	32.00	4.50	—	I2BB	12307	20.00	35.00	10.00	—	I5BB
16415	19.10	76.20	22.00	—	TDUO	17891	20.00	32.00	5.00	—	I5BA	12307	20.00	35.00	10.00	—	I5BB
—	19.30	29.10	6.40	—	I5BB	—	20.00	32.00	5.00	—	I4BA	12307	20.00	35.00	10.00	—	I5BB
—	—	—	—	—	—	20812	20.00	32.00	5.00	—	I5BA	13255	20.00	35.00	10.00	—	I9BB
—	19.50	35.00	13.00	—	I1FC	—	20.00	32.00	6.00	—	I2BB	20823	20.00	35.00	10.00	—	I2BA
12976	19.50	46.60	16.00	—	I5C	—	20.00	32.00	6.00	—	I5BB	18416	20.00	35.00	10.00	—	I2BB
—	19.84	25.40	3.97	—	I4BB	13490	20.00	32.00	6.00	—	ESPE	20057	20.00	35.00	12.00	—	I5BB
20803	19.84	31.35	7.54	—	I5BA	14175	20.00	32.00	6.00	—	I5BB	16094	20.00	35.20	10.00	—	I5BB
20804	19.84	31.75	6.35	—	I2B.	20813	20.00	32.00	6.00	—	I5BB	—	—	—	—	—	—
—	—	—	—	—	—	14175	20.00	32.00	6.00	—	I5BA	—	20.00	35.30	6.00	—	I4BB
20805	19.84	34.93	10.32	—	I5BB	20814	20.00	32.00	6.50	—	I5BA	12213	20.00	35.50	5.80	—	I4BB
20806	19.84	38.10	6.35	—	I5BA	—	—	—	—	—	—	—	—	—	—	—	—



# Retentores

Perfis - Ver Última Página



INCOVE VEDAÇÕES LTDA.

Cod.	Di	De	Ha1	Ha2	Mod	Cod.	Di	De	Ha1	Ha2	Mod	Cod.	Di	De	Ha1	Ha2	Mod
12711	20.00	36.00	7.00	—	I2BB	25370	20.00	42.00	6.00	—	I4BB	—	20.00	72.00	9.00	—	I2BB
20825	20.00	36.00	8.00	—	I5BB	25370	20.00	42.00	6.00	—	I2BB	16865	20.00	100.00	26.00	—	TDUO
—	20.00	36.00	10.00	—	I2BB	14186	20.00	42.00	7.00	—	I5BB	25401	20.00	100.00	26.00	—	TDUO
14179	20.00	36.00	10.00	—	I5BB	14186	20.00	42.00	7.00	—	I5BB	11730	20.00	120.00	40.00	—	TDUO
—	20.00	36.00	10.00	—	I5BB	20838	20.00	42.00	7.00	—	I5BA	20323	20.00	125.00	30.00	—	TDUO
14179	20.00	37.00	8.00	—	I2BB	11088	20.00	42.00	7.00	—	I2BB	20361	20.00	140.00	30.00	—	TDUO
12907	20.00	37.00	8.00	11.00	I2BB	11088	20.00	42.00	7.00	—	I2BB	11787	20.00	150.00	40.00	—	TDUO
—	20.00	37.00	10.00	—	I2BB	—	20.00	42.00	10.00	—	I2BB	16373	20.00	152.00	40.50	—	TDUO
14180	20.00	37.00	10.00	—	I5BB	13161	20.00	42.00	10.00	—	I5B.	—	20.50	41.10	7.00	—	I2BB
—	20.00	37.00	10.00	—	I5BB	14187	20.00	42.00	10.00	—	I5BB	—	20.50	41.20	5.00	—	I2BA
14180	20.00	37.00	10.00	—	I5BB	14187	20.00	42.00	10.00	—	I5BA	16711	20.50	46.65	15.80	—	I1BF
20827	20.00	37.00	11.00	—	I5BB	20839	20.00	42.00	10.00	—	I2BA	16691	20.60	28.60	3.10	—	I4BA
20828	20.00	37.30	6.35	—	I5BB	—	20.00	43.00	7.00	—	I13	—	20.60	31.70	4.90	—	I2BA
14686	20.00	37.30	6.40	—	I5BB	20840	20.00	43.00	7.00	—	I5BB	—	20.60	31.75	5.00	—	I5BA
—	20.00	37.30	6.40	—	I5BB	14093	20.00	44.00	3.00	—	I4B.	—	20.60	38.11	7.00	—	I2BA
14686	20.00	38.00	5.00	—	I2BB	—	20.00	45.00	7.00	—	I2BB	11871	20.63	34.92	6.35	—	I5BB
—	20.00	38.00	6.00	—	I2BB	20842	20.00	45.00	10.00	—	I5BB	—	20.64	26.99	3.18	—	I4BA
12645	20.00	38.00	6.00	—	I5BA	14188	20.00	45.00	10.00	—	I5B.	18931	20.64	27.78	4.76	—	I4BA
12645	20.00	38.00	6.40	—	I5BA	16116	20.00	45.00	12.00	—	I5BA	20852	20.64	28.50	9.53	—	I5BA
—	20.00	38.00	7.00	—	I2BB	—	20.00	46.00	7.00	—	I2BB	—	20.64	30.16	5.16	—	I4BA
20829	20.00	38.00	7.00	—	I5BB	14189	20.00	47.00	5.00	—	I5BB	13614	20.64	31.75	3.97	—	I4B.
16923	20.00	38.00	8.00	—	I5BB	14189	20.00	47.00	5.00	—	I5BA	13424	20.64	31.75	4.76	—	I4BA
20076	20.00	38.00	8.00	—	I2BB	14189	20.00	47.00	5.00	—	I5B.	17891	20.64	31.75	6.35	—	I5BB
11567	20.00	38.00	10.00	—	I2BB	—	20.00	47.00	7.00	—	I2BB	17891	20.64	31.75	6.35	—	I5BA
—	20.00	38.00	18.00	—	I7B.	11113	20.00	47.00	7.00	—	I5BB	20854	20.64	31.75	7.94	—	I5B.
22576	20.00	38.00	18.00	—	ESPE	20843	20.00	47.00	7.00	—	I5BA	11076	20.64	31.75	8.50	—	I2BB
20830	20.00	39.00	5.00	—	I5BB	16000	20.00	47.00	7.00	—	I2BB	11076	20.64	31.75	8.50	—	I2BA
14181	20.00	39.00	5.00	—	I5BA	—	20.00	47.00	8.00	—	I2BB	20855	20.64	31.75	9.40	—	I2BB
—	20.00	39.70	6.50	—	I2BB	13812	20.00	47.00	9.50	—	I13	17716	20.64	31.75	9.52	—	I5BA
—	20.00	39.80	6.50	—	I2BB	—	20.00	47.00	10.00	—	I5BB	17716	20.64	31.75	9.52	—	I5B.
—	20.00	40.00	4.00	—	I4BB	—	20.00	47.00	10.00	—	I2BB	15826	20.64	31.75	20.64	—	REPA
13129	20.00	40.00	4.00	—	I5BA	—	20.00	47.00	10.00	—	I5B.	15062	20.64	33.34	6.35	—	I1BF
13129	20.00	40.00	4.00	—	I5BA	14190	20.00	47.00	10.00	—	I5BB	20856	20.64	33.34	10.32	—	I5BB
—	20.00	40.00	6.00	—	I2BB	13118	20.00	47.00	10.00	12.00	ESPE	20857	20.64	34.64	11.91	—	I2BA
14182	20.00	40.00	6.00	—	I5BB	13118	20.00	47.00	10.00	12.00	I4BA	—	20.64	34.93	4.76	—	I4BA
14182	20.00	40.00	6.00	—	I5BA	—	20.00	47.00	10.00	—	I13	—	20.64	34.93	6.35	—	I4BA
14033	20.00	40.00	6.50	0.90	ESPE	16679	20.00	47.00	10.00	—	I4JM	18411	20.64	34.93	6.35	—	I4B.
20831	20.00	40.00	6.50	—	I2BB	14190	20.00	47.00	10.00	—	I5BB	13255	20.64	34.93	9.52	—	I9BB
13491	20.00	40.00	7.00	—	I5BB	20844	20.00	47.00	10.00	—	I5B.	11565	20.64	34.93	9.52	—	I2BA
—	20.00	40.00	7.00	—	I2BB	14190	20.00	47.00	10.00	—	I5BA	15056	20.64	34.93	10.32	—	I5C
13491	20.00	40.00	7.00	—	I5BA	14190	20.00	47.00	10.00	—	I5C	20859	20.64	34.93	11.11	—	I5B.
14183	20.00	40.00	7.00	—	I2BB	20845	20.00	47.00	11.00	—	I5BA	18416	20.64	34.93	12.70	—	I2BA
—	20.00	40.00	7.00	—	I2BB	—	20.00	47.00	13.00	—	I3B	20860	20.64	34.93	12.70	—	I5BB
13491	20.00	40.00	7.00	—	I5BA	19958	20.00	47.00	13.00	—	I3BC	18416	20.64	34.93	12.70	—	I2BB
14183	20.00	40.00	7.00	—	I2BB	—	20.00	47.00	16.00	—	I7B.	18415	20.64	34.93	12.70	—	I120
20832	20.00	40.00	7.00	—	I2BA	13128	20.00	47.00	16.00	—	I7BB	14010	20.64	34.93	14.29	—	I7B.
14182	20.00	40.00	7.00	—	I5BB	—	20.00	48.00	7.00	—	I2BB	20861	20.64	35.32	11.11	—	I5BB
14183	20.00	40.00	7.00	—	I2BA	—	20.00	48.00	7.50	—	I2BB	18932	20.64	36.51	6.35	—	I4BB
—	20.00	40.00	7.00	—	I2BB	20846	20.00	48.00	10.00	—	I5BB	—	20.64	36.51	6.35	—	I4BA
14183	20.00	40.00	7.00	—	I2BB	14191	20.00	48.00	10.00	—	I5B.	15735	20.64	36.51	17.46	—	REPA
—	20.00	40.00	7.90	—	I2BB	—	20.00	50.00	7.00	—	I2BB	18026	20.64	36.51	23.81	—	SANF
11914	20.00	40.00	10.00	—	I2BB	11718	20.00	50.00	10.00	—	I5BB	20862	20.64	38.10	6.35	—	I5BB
14184	20.00	40.00	10.00	—	I5BB	16184	20.00	52.00	6.35	—	I2BB	18968	20.64	38.10	6.35	—	I5B.
14184	20.00	40.00	10.00	—	I5BA	20848	20.00	52.00	6.50	—	I5BB	15646	20.64	38.10	9.92	—	I5BB
—	20.00	40.00	10.00	—	I13	—	20.00	52.00	7.00	—	I2BB	15646	20.64	38.10	9.92	—	I5BA
20833	20.00	40.00	10.00	—	I5BB	20849	20.00	52.00	7.00	—	I5B.	15646	20.64	38.10	9.92	—	I5B.
20834	20.00	40.00	10.00	—	I5BA	—	20.00	52.00	10.00	—	I2BB	15646	20.64	38.10	9.92	—	I5C
11914	20.00	40.00	10.00	—	I2BA	—	20.00	52.00	10.00	13.00	I4BA	14003	20.64	38.10	18.26	—	I7B.
14184	20.00	40.00	10.00	—	I5B.	14192	20.00	52.00	10.00	—	I5BB	18903	20.64	38.10	18.26	—	I9B.
11914	20.00	40.00	10.00	—	I2B.	14192	20.00	52.00	10.00	—	I5BA	15646	20.64	38.13	9.92	—	I5BB
14185	20.00	40.00	13.00	—	I5BA	14192	20.00	52.00	10.00	—	I5B.	14859	20.64	39.69	4.76	—	I5BB
20837	20.00	40.00	13.00	—	I5BA	20850	20.00	52.00	14.00	—	I5BB	18417	20.64	39.69	9.52	—	I5BB
—	20.00	40.00	14.00	—	I7B.	14193	20.00	53.00	7.00	—	I13	20863	20.64	39.69	9.53	—	I2BA
18059	20.00	40.00	23.00	—	N TE	20851	20.00	55.00	7.00	—	I5BB	15810	20.64	39.69	19.05	—	REPA
14033	20.00	40.50	7.00	—	I5BA	14033	20.00	60.00	7.00	—	I5BA	18412	20.64	41.28	4.76	—	I2BA
—	20.00	41.30	6.70	—	I5BB	16635	20.00	62.00	9.50	—	I2BA	20168	20.64	41.28	4.76	—	I2BA



# Retentores

Perfis - Ver Última Página



INCOVE VEDAÇÕES LTDA.

Cod.	Di	De	Ha1	Ha2	Mod	Cod.	Di	De	Ha1	Ha2	Mod	Cod.	Di	De	Ha1	Ha2	Mod
20864	20.64	41.28	5.16	—	I2BA	12646	21.80	25.00	1.90	—	I4BA	11105	22.00	35.00	7.00	—	I2BB
20865	20.64	41.28	7.94	—	I5BA	—	21.80	35.00	7.00	—	I2BB	—	22.00	35.00	7.00	—	I2BB
18418	20.64	41.28	11.11	—	I5BB	—	21.80	35.00	7.00	—	I2BB	—	22.00	35.00	7.00	—	I2BB
18225	20.64	42.86	9.52	—	I5B.	—	21.81	25.00	1.98	—	I4BA	—	22.00	35.00	7.00	—	I4C
20866	20.64	42.86	9.53	—	I5BB	20883	21.81	36.51	6.35	—	I5BA	20893	22.00	35.00	7.00	—	I5BB
18969	20.64	44.45	6.35	—	I4BA	14194	22.00	27.00	4.00	—	I4BA	22574	22.00	35.00	7.00	—	I5BA
20867	20.64	44.45	6.35	—	I5BB	14194	22.00	27.00	4.00	—	I4B.	11105	22.00	35.00	7.00	—	I2BB
13449	20.64	44.45	7.94	—	I5BB	12141	22.00	28.00	4.00	—	I4BA	25404	22.00	35.00	7.00	—	I5B.
18413	20.64	44.45	11.11	—	I5BB	20884	22.00	28.00	4.00	—	I5BB	25422	22.00	35.00	7.50	—	I5BA
18413	20.64	44.45	11.11	—	I5B.	16869	22.00	28.00	6.00	—	I4BA	12654	22.00	35.00	8.00	—	I4BA
15491	20.64	46.04	11.11	—	I5B.	—	22.00	28.55	3.00	—	I4BA	20894	22.00	35.00	8.00	—	I5BA
18971	20.64	46.43	6.35	—	I4BA	—	22.00	29.00	7.00	—	I4BB	16423	22.00	35.00	8.00	—	I2BB
18970	20.64	46.43	11.11	—	I5BA	12142	22.00	30.00	4.00	—	I4BA	14196	22.00	35.00	9.00	—	I2BA
18970	20.64	46.43	11.11	—	I5B.	—	22.00	30.00	6.00	—	I2BB	14196	22.00	35.00	9.00	11.00	I2BB
20869	20.64	46.64	6.35	—	I5BB	20371	22.00	30.00	7.00	—	I5BB	14196	22.00	35.00	9.00	—	I2BA
20870	20.64	47.63	11.11	—	I5BB	13057	22.00	30.00	7.00	—	I5BA	—	22.00	35.00	10.00	—	I5BA
18419	20.64	47.63	11.11	—	I5B.	—	22.00	31.00	7.00	—	I2BB	—	22.00	35.00	10.00	—	I2BB
20871	20.64	49.21	6.35	—	I5BB	14114	22.00	31.00	7.00	—	I2BA	18420	22.00	35.00	10.00	—	I2BA
20872	20.64	50.80	7.94	—	I2BB	—	22.00	31.00	7.00	—	I4BA	20896	22.00	35.00	10.00	—	I5BA
15025	20.64	61.91	11.11	—	I1BF	25352	22.00	31.75	7.00	—	I5BB	—	22.00	35.00	10.00	—	I2BB
18077	20.64	65.09	12.70	—	I55	13926	22.00	32.00	3.00	—	I4BA	20895	22.00	35.00	10.00	—	I2B.
13207	21.00	27.00	12.00	—	I4BA	—	22.00	32.00	4.50	—	I2BB	12068	22.00	35.50	10.00	—	ESPE
13768	21.00	28.00	5.50	—	I5B	16300	22.00	32.00	5.00	1.50	ESPE	11537	22.00	37.00	5.00	—	I5BB
—	21.00	28.00	5.50	—	I4BA	—	22.00	32.00	5.00	—	I4BA	25437	22.00	37.00	6.00	—	I5BB
12140	21.00	29.00	4.00	—	I4BA	20179	22.00	32.00	5.00	—	I5BB	14197	22.00	37.00	7.00	—	I5BB
—	21.00	30.00	6.50	—	I2BB	20179	22.00	32.00	5.00	—	I5BB	—	22.00	37.00	7.00	—	I2BB
20873	21.00	30.00	6.50	—	I5BA	20179	22.00	32.00	5.00	—	I5BA	14197	22.00	37.00	7.00	—	I5BB
25456	21.00	30.00	7.00	—	I5BB	20179	22.00	32.00	5.00	—	I5BA	14197	22.00	37.00	7.00	—	I5BB
16403	21.00	30.00	8.00	—	I5BB	11549	22.00	32.00	5.50	—	I5BB	16324	22.00	37.00	8.00	—	I2BB
12345	21.00	30.00	12.00	—	ESPE	11549	22.00	32.00	5.50	—	I5BB	—	22.00	37.00	10.00	—	I2BB
12345	21.00	30.00	12.00	—	ESPE	20885	22.00	32.00	5.50	—	I5BB	11799	22.00	38.00	5.00	—	I5BA
—	21.00	30.20	7.00	—	I5BB	20886	22.00	32.00	5.50	—	I5BA	—	22.00	38.00	7.00	—	I2BB
11137	21.00	31.00	3.50	—	I5BB	—	22.00	32.00	6.00	—	I5BA	11843	22.00	38.00	8.00	—	I2BA
16553	21.00	31.75	4.80	—	I4BA	—	22.00	32.00	7.00	—	I2BB	11843	22.00	38.00	8.00	—	I2B.
13005	21.00	32.00	4.40	—	I4B.	16318	22.00	32.00	7.00	—	I2BB	11843	22.00	38.00	8.00	—	I5BA
16540	21.00	32.00	5.00	—	I4BA	—	22.00	32.00	7.00	—	I4BB	—	22.00	38.00	10.00	—	I2BB
11802	21.00	32.00	7.00	—	I2BA	14700	22.00	32.00	7.00	—	I5BA	12714	22.00	38.00	10.00	—	I4BA
12231	21.00	32.00	7.00	—	I5BB	14195	22.00	32.00	7.00	—	I5BB	13444	22.00	40.00	3.00	—	I4BA
12249	21.00	32.00	7.00	9.00	I2BA	14195	22.00	32.00	7.00	—	I5BA	—	22.00	40.00	3.00	—	I13
—	21.00	32.00	7.00	—	I4BA	20887	22.00	32.00	7.00	—	I2BA	14725	22.00	40.00	3.00	—	I13
12231	21.00	32.00	7.00	—	I5BB	—	22.00	32.00	7.00	—	I7B.	13444	22.00	40.00	3.00	—	I4BA
11802	21.00	32.00	7.00	—	I2BA	13084	22.00	32.00	7.00	10.00	I2B.	—	22.00	40.00	6.50	—	I5BB
—	21.00	32.00	7.50	—	I2BA	—	22.00	32.00	7.80	—	I2BB	—	22.00	40.00	7.00	—	I5BB
—	21.00	32.00	7.50	—	I2BA	13598	22.00	32.00	8.00	—	I5BB	—	22.00	40.00	7.00	—	I2BA
12639	21.00	32.00	7.50	—	I5BA	13598	22.00	32.00	8.00	—	I2BB	14198	22.00	40.00	7.00	—	I5BB
13091	21.00	35.00	7.00	8.00	I2BB	13598	22.00	32.00	8.00	—	I2BB	14198	22.00	40.00	7.00	—	I5BB
20875	21.00	35.00	8.00	—	I5BB	20888	22.00	32.00	9.00	—	I5BA	14198	22.00	40.00	7.00	—	I5BA
20877	21.00	35.00	—	—	I5B.	—	22.00	32.00	10.00	—	I2BB	20394	22.00	40.00	7.00	—	I2BB
12806	21.00	37.00	7.00	—	I4BB	20889	22.00	32.00	12.00	—	I5BB	20900	22.00	40.00	7.00	—	I2BA
—	21.00	37.00	7.00	10.00	I2BB	14109	22.00	33.00	6.00	—	I5BB	—	22.00	40.00	8.00	—	I2B
12806	21.00	37.00	7.00	—	I4BB	—	22.00	33.00	7.00	—	I2BB	12235	22.00	40.00	8.00	—	I5B.
20878	21.00	38.50	10.00	—	I5B.	13094	22.00	33.00	7.00	8.00	I2BB	14877	22.00	40.00	8.00	—	I2BB
—	21.00	39.60	10.00	—	I5BB	20890	22.00	33.00	8.00	—	I5BB	20901	22.00	40.00	8.00	—	I5BB
—	21.00	40.00	7.00	—	I2BB	16514	22.00	33.85	9.00	2.90	I2BB	14877	22.00	40.00	8.00	—	I2BB
20879	21.00	40.00	10.00	—	I5BB	—	22.00	34.00	4.00	—	I4BB	12235	22.00	40.00	8.00	—	I5B.
—	21.00	47.00	10.00	—	I4BA	—	22.00	34.00	5.00	—	I2BB	20902	22.00	40.00	9.00	—	I2BB
—	21.03	38.10	6.35	—	I4BB	—	22.00	34.00	5.00	—	I2BB	—	22.00	40.00	10.00	—	I2BB
20880	21.43	28.97	7.94	—	I5B.	—	22.00	34.00	5.00	—	I4BB	20903	22.00	40.00	10.00	—	I5BB
20881	21.43	38.10	9.92	—	I5B.	14883	22.00	34.00	5.00	—	I4BB	20904	22.00	40.00	10.00	—	I5BA
—	21.43	38.10	10.32	—	I5C	—	22.00	35.00	5.00	—	I2BB	16016	22.00	40.00	10.00	—	I5B.
20882	21.43	41.28	11.11	—	I5BB	12808	22.00	35.00	5.00	—	I4BB	20905	22.00	40.00	11.00	—	I2BB
16975	21.50	32.00	6.30	—	I2BB	20891	22.00	35.00	5.00	—	I5BB	—	22.00	40.00	13.00	—	I2BB
16419	21.50	35.00	6.12	—	I2BA	—	22.00	35.00	6.00	—	I2BB	17929	22.00	40.00	15.00	—	ESPE
11192	21.50	38.10	8.00	—	I5BB	11288	22.00	35.00	6.00	—	I2BB	17929	22.00	40.00	15.00	—	ESPE
—	21.50	40.00	7.00	—	I5BB	20892	22.00	35.00	6.40	—	I5BB	17929	22.00	40.00	15.00	—	ESPE
—	21.50	40.00	7.00	—	I5BB	—	22.00	35.00	7.00	—	I2BB	17929	22.00	40.00	15.00	—	ESPE
—	21.70	35.00	11.00	—	I2BB	15218	22.00	35.00	7.00	—	I5BB	—	22.00	41.00	5.50	—	I4BB





# Retentores

Perfis - Ver Última Página



INCOVE VEDAÇÕES LTDA.

Cod.	Di	De	Ha1	Ha2	Mod	Cod.	Di	De	Ha1	Ha2	Mod	Cod.	Di	De	Ha1	Ha2	Mod
20906	22.00	41.00	9.00	—	15BB	—	22.22	38.07	9.92	—	15BB	20181	22.23	36.51	6.35	—	15BB
16300	22.00	41.40	5.00	1.50	14BA	—	22.22	38.07	12.20	—	12BA	20181	22.23	36.51	6.35	—	15BA
—	22.00	42.00	7.00	—	12BB	—	22.22	38.80	9.91	—	15BB	20923	22.23	36.51	6.35	—	12BB
13904	22.00	42.00	8.00	—	15BB	—	22.22	39.90	6.35	—	14BA	20181	22.23	36.51	6.35	—	15B.
—	22.00	42.00	10.00	—	12BB	—	22.22	41.25	11.11	—	15BB	18973	22.23	36.51	6.35	—	15C
14200	22.00	42.00	10.00	—	15BB	—	22.22	52.00	10.00	—	15BA	20181	22.23	36.51	6.35	—	15BA
14200	22.00	42.00	10.00	—	15BB	17046	22.23	28.58	3.17	—	14BB	15886	22.23	36.51	14.29	—	113
14200	22.00	42.00	10.00	—	15BB	17046	22.23	28.58	3.17	—	14BA	14015	22.23	36.51	15.87	—	REPA
13668	22.00	42.00	11.00	—	15BA	17046	22.23	28.58	3.17	—	14B.	14749	22.23	38.10	4.76	—	1131
20909	22.00	42.00	11.00	—	12BB	20917	22.23	28.58	4.76	—	15BA	20924	22.23	38.10	6.35	—	15BA
20910	22.00	43.00	8.60	—	15B.	RU01	22.23	28.58	5.56	—	14BA	16866	22.23	38.10	6.35	—	12BA
20912	22.00	43.00	10.00	—	15BB	—	22.23	28.58	5.56	—	14BB	13280	22.23	38.10	7.94	—	15BB
—	22.00	45.00	7.00	—	12BB	11125	22.23	28.58	9.52	—	15BA	20169	22.23	38.10	7.94	—	14BA
20913	22.00	45.00	7.00	—	15BB	18972	22.23	30.16	4.76	—	14BA	13280	22.23	38.10	7.94	—	15BB
—	22.00	45.00	8.00	—	12BB	18972	22.23	30.16	4.76	—	14B	20169	22.23	38.10	7.94	—	14BA
16062	22.00	45.00	8.00	—	15BB	20918	22.23	30.16	7.14	—	15BA	20182	22.23	38.10	7.94	—	12BB
14202	22.00	45.00	12.00	—	18BB	—	22.23	31.75	3.97	—	14BA	12731	22.23	38.10	7.94	—	15BB
—	22.00	45.00	12.00	—	18BB	18152	22.23	31.75	3.97	—	ESPE	13280	22.23	38.10	7.94	—	15BA
14202	22.00	45.00	12.00	—	18BB	RU08	22.23	31.75	4.76	—	14BA	20925	22.23	38.10	7.94	—	12B.
20914	22.00	45.00	12.00	—	15BB	17319	22.23	31.75	5.00	—	14BA	15477	22.23	38.10	7.94	—	14BA
14201	22.00	45.00	12.00	—	15BA	15061	22.23	31.75	6.35	—	F	—	22.23	38.10	7.94	—	17B.
14201	22.00	45.00	12.00	—	15B.	17319	22.23	31.75	6.35	—	14BB	20926	22.23	38.10	8.33	—	12BA
—	22.00	46.00	7.00	—	12BB	20178	22.23	31.75	6.35	—	15BA	18086	22.23	38.10	9.52	—	17B.
12350	22.00	46.00	10.00	—	15BB	20178	22.23	31.75	6.35	—	15BA	20927	22.23	38.10	9.53	—	15BA
12068	22.00	46.00	10.00	—	15BB	11415	22.23	31.75	6.35	—	12BB	15143	22.23	38.10	9.92	—	15B.
20177	22.00	46.50	10.00	—	12BA	—	22.23	31.75	9.53	—	17BA	20929	22.23	38.10	9.92	—	15BB
—	22.00	47.00	7.00	—	12BB	12719	22.23	32.54	6.35	—	15B.	20928	22.23	38.10	9.92	—	15B.
12878	22.00	47.00	7.00	—	15BB	—	22.23	33.34	4.76	—	14BB	15143	22.23	38.10	9.92	—	15C
12878	22.00	47.00	7.00	—	15BA	18990	22.23	33.34	4.76	—	14BB	20930	22.23	38.10	11.11	—	15B.
14156	22.00	47.00	9.00	—	15B.	18990	22.23	33.34	4.76	—	14C	20931	22.23	38.10	12.70	—	12BA
20915	22.00	47.00	9.00	—	15B.	20919	22.23	33.34	6.35	—	15BB	18349	22.23	38.10	12.70	—	12B.
20916	22.00	47.00	10.00	—	15BB	20920	22.23	33.34	6.35	—	15BA	17428	22.23	38.10	15.87	—	11BF
14156	22.00	47.00	10.00	—	15BA	15868	22.23	33.34	6.35	—	15B.	—	22.23	39.69	6.35	—	14BA
14156	22.00	47.00	10.00	—	15B.	15868	22.23	33.34	6.35	—	15C	15219	22.23	39.69	6.35	—	14B.
11008	22.00	47.00	10.00	—	12BB	13345	22.23	33.34	7.94	—	14BB	20932	22.23	39.69	6.35	—	15BA
13040	22.00	47.00	14.00	—	13BC	13344	22.23	33.34	9.52	—	15BA	11563	22.23	39.69	6.35	—	12BA
—	22.00	48.00	10.00	—	12BB	13344	22.23	33.34	9.52	—	15C	18974	22.23	40.08	6.35	—	14BA
20917	22.00	48.00	11.00	—	15B.	20921	22.23	33.34	9.53	—	15BA	18421	22.23	40.08	9.52	—	15B.
—	22.00	50.00	8.00	—	12BB	14883	22.23	34.13	4.76	—	14BB	18421	22.23	40.08	9.52	—	15BA
12889	22.00	50.00	10.00	—	15BB	15218	22.23	34.93	6.35	—	15BA	18421	22.23	40.08	9.52	—	15B.
—	22.00	52.00	7.00	—	12BB	15218	22.23	34.93	6.35	—	15BB	18421	22.23	40.08	10.32	—	15BB
—	22.00	62.00	7.00	—	12BB	20922	22.23	34.93	6.35	—	15BA	13218	22.23	41.28	3.17	—	14BB
16559	22.00	81.30	22.00	—	TDUO	13296	22.23	34.93	6.35	—	12BB	18975	22.23	41.28	6.35	—	15BA
—	22.20	31.70	6.00	—	15BA	15218	22.23	34.93	6.35	—	15B.	18975	22.23	41.28	6.35	—	15BB
—	22.20	31.70	6.00	—	12BA	13296	22.23	34.93	6.35	—	12BB	18975	22.23	41.28	6.35	—	15BA
—	22.20	34.90	6.35	—	15BB	13296	22.23	34.93	6.35	—	12BA	13126	22.23	41.28	7.94	—	15BA
—	22.20	34.90	6.40	—	15BB	13295	22.23	34.93	7.94	—	15BA	20933	22.23	41.28	7.94	—	15BB
—	22.20	34.98	6.50	—	12BA	19909	22.23	34.93	7.94	—	12BA	13126	22.23	41.28	7.94	—	15BA
11918	22.20	38.10	7.90	—	15BB	19909	22.23	34.93	7.94	—	12B.	20934	22.23	41.28	8.33	—	12B.
16133	22.20	38.89	10.31	—	12BA	19909	22.23	34.93	7.94	—	15B.	20936	22.23	41.28	9.53	—	15BA
11658	22.20	50.70	6.00	—	15BB	—	22.23	34.93	7.94	—	14BA	20935	22.23	41.28	9.53	—	12B.
20014	22.20	50.70	12.70	—	15BB	13295	22.23	34.93	7.94	—	15BA	15220	22.23	41.28	11.11	—	15BA
—	22.20	50.80	10.80	—	12BA	13295	22.23	34.93	7.94	—	15B	15220	22.23	41.28	11.11	—	15C
—	22.22	28.50	4.00	—	14BA	19909	22.23	34.93	7.94	—	12BB	15220	22.23	41.28	11.11	—	15C
17319	22.22	31.75	5.00	—	15BA	19909	22.23	34.93	7.94	—	12BA	20937	22.23	41.28	12.70	—	12BB
17319	22.22	31.75	6.35	—	15BA	20922	22.23	34.93	7.94	—	15B.	18071	22.23	42.07	13.49	—	14C
—	22.22	31.85	4.76	—	15BB	19909	22.23	34.93	7.94	—	12B.	18118	22.23	42.86	14.29	—	REPA
—	22.22	33.22	9.52	—	15BB	15779	22.23	34.93	9.52	—	15BA	18976	22.23	44.45	6.35	—	14BB
—	22.22	33.24	6.35	—	15BB	15779	22.23	34.93	9.52	—	15BB	—	22.23	44.45	6.35	—	14BA
13911	22.22	33.35	4.76	—	15BB	15779	22.23	34.93	9.52	—	15B.	20938	22.23	44.45	7.94	—	15B.
22506	22.22	34.89	10.31	—	12BA	13476	22.23	34.93	9.52	—	12B.	13802	22.23	44.45	7.94	—	12BA
—	22.22	34.92	6.35	—	12BA	13450	22.23	34.93	11.91	—	12BA	17963	22.23	44.45	9.52	—	15BB
—	22.22	34.92	7.93	—	12BB	15218	22.23	34.95	6.35	—	15BB	17963	22.23	44.45	9.52	—	15BA
15218	22.22	34.93	6.35	—	15BB	15218	22.23	34.95	6.35	—	15BB	17963	22.23	44.45	9.52	—	15BA
—	22.22	35.00	6.40	—	12BB	15218	22.23	34.95	6.35	—	15BB	20939	22.23	44.45	9.53	—	12BA
—	22.22	36.40	6.35	—	14BA	18973	22.23	36.51	6.35	—	15BA	18422	22.23	44.45	15.87	—	11FB
—	22.22	38.05	8.00	—	15BA	18973	22.23	36.51	6.35	—	14BB	15916	22.23	44.45	44.45	—	REPA





# Retentores

Perfis - Ver Última Página



INCOVE VEDAÇÕES LTDA.

Cod.	Di	De	Ha1	Ha2	Mod	Cod.	Di	De	Ha1	Ha2	Mod	Cod.	Di	De	Ha1	Ha2	Mod
15193	22.23	45.24	9.52	—	I55	11112	23.00	40.00	10.00	—	I5BB	19919	23.81	39.69	12.70	—	ESP
13278	22.23	46.04	7.94	—	I5B.	20952	23.00	41.00	9.50	—	I5B.	18426	23.81	41.28	6.35	—	I4BB
15630	22.23	46.04	11.11	—	I5B.	—	23.00	42.00	10.00	—	I2BB	—	23.81	41.28	6.35	—	I4BA
18978	22.23	46.43	6.35	—	I4BB	16050	23.00	42.00	10.00	—	I5BB	13694	23.81	41.28	7.94	—	I4BA
20940	22.23	46.43	6.35	—	I5BB	11443	23.00	43.00	9.00	—	I5BB	20962	23.81	41.28	7.94	—	I5BA
13664	22.23	46.43	9.13	—	I5B.	13841	23.00	43.00	10.00	—	I2BB	13383	23.81	41.28	9.52	—	I5BB
20942	22.23	46.43	9.35	—	I5B.	20953	23.00	47.00	10.00	—	I5BA	13383	23.81	41.28	9.52	—	I5C
18977	22.23	46.43	11.11	—	I5B.	14204	23.00	47.00	12.00	—	I5BA	17243	23.81	41.28	11.11	—	I5BA
—	22.23	46.43	15.88	—	I1FB	14204	23.00	47.00	12.00	—	I5C	17243	23.81	41.28	11.11	—	I5B.
16749	22.23	46.53	9.52	—	I2BA	—	23.00	47.00	12.00	—	I5C	17243	23.81	41.28	11.11	—	I5C
13606	22.23	46.83	6.35	—	I5BB	16954	23.00	47.50	10.00	—	I7BB	18427	23.81	42.86	7.94	—	I5B.
11339	22.23	46.83	6.35	—	I2BA	13739	23.00	47.55	11.50	—	I5C	18427	23.81	42.86	7.94	—	I5B.
15578	22.23	46.83	11.11	—	I5BB	20954	23.00	48.00	12.00	—	I5BB	20963	23.81	43.83	11.11	—	I5BB
15578	22.23	46.83	11.11	—	I5B.	14205	23.00	48.00	12.00	—	I5BA	—	23.81	44.45	6.35	—	I4BA
—	22.23	46.83	13.89	—	I3B	14205	23.00	48.00	12.00	—	I5B.	15383	23.81	44.45	6.35	—	I4B.
18979	22.23	47.63	6.35	—	I4BA	13389	23.00	48.50	7.50	—	I5BB	13472	23.81	44.45	7.94	—	I5BA
20943	22.23	47.63	6.35	—	I5BB	12501	23.00	50.00	10.00	—	I5B.	13472	23.81	44.45	7.94	—	I5BA
13594	22.23	47.63	6.35	—	I5BA	16784	23.00	50.00	10.00	—	I2BB	—	23.81	44.45	8.33	—	I13
13607	22.23	47.63	9.52	—	I2BB	20955	23.02	38.10	9.53	—	I5B.	20964	23.81	44.45	9.13	—	I5BB
20944	22.23	47.63	11.11	—	I5BB	11209	23.02	44.45	6.35	—	I5BB	18346	23.81	44.45	11.11	—	I5B.
18423	22.23	47.63	11.11	—	I5BA	20956	23.02	44.45	11.11	—	I5BB	17927	23.81	44.45	16.67	—	I13
18423	22.23	47.63	11.11	—	I5B.	18313	23.02	44.45	11.11	—	I5BA	14094	23.81	46.04	9.52	—	I5BA
12641	22.23	50.80	11.11	—	I2BA	14716	23.30	59.95	6.40	—	I4BA	14094	23.81	46.04	9.52	—	I5B.
18424	22.23	50.80	11.11	—	I5BB	14716	23.30	59.95	6.40	—	I4C	14094	23.81	46.04	9.52	—	I5C
18424	22.23	50.80	11.11	—	I5BA	13407	23.50	38.10	6.35	—	I5BB	—	23.81	46.04	9.53	—	I5C
18424	22.23	50.80	11.11	—	I5B.	16209	23.70	38.10	9.50	—	I5C	15671	23.81	46.83	11.11	—	I5BA
12641	22.23	50.80	11.11	—	I2BA	12286	23.80	34.70	6.90	—	I5BB	20965	23.81	46.83	11.11	—	I5B.
18425	22.23	52.39	9.52	—	I13	12567	23.80	35.30	2.30	5.30	ESPE	17118	23.81	46.83	15.87	—	I1FC
15269	22.23	52.39	9.52	—	I5BB	—	23.80	38.05	6.50	—	I2BA	17118	23.81	46.83	18.87	—	I1FB
15269	22.23	52.39	9.52	—	I5B.	12297	23.80	39.00	6.20	—	I4BB	15935	23.81	47.63	25.40	—	REPA
15554	22.23	69.85	12.70	—	F	20004	23.80	50.80	9.53	—	I5BB	20966	23.81	50.80	12.70	—	I5BB
20946	22.23	73.03	12.70	—	I5BB	16064	23.80	52.00	9.50	—	I2BB	20967	23.81	50.80	12.70	—	I5B.
15297	22.23	73.03	12.70	—	I5B.	11178	23.81	28.58	3.17	—	I4BA	13898	23.81	53.98	9.52	—	ESPE
—	22.30	46.00	10.00	—	ESPE	17892	23.81	31.75	1.58	—	I4B.	20968	23.81	57.15	12.70	—	I5BB
12037	22.50	29.00	3.20	—	I4BB	—	23.81	31.75	4.76	—	I4BB	18429	23.81	57.15	12.70	—	I5B.
20103	22.50	82.25	22.00	—	TDUO	18147	23.81	33.34	3.17	—	F	11302	24.00	30.00	7.00	—	I4BB
20947	22.62	34.93	6.35	—	I2B.	20957	23.81	34.70	6.90	—	I5BB	—	24.00	31.00	5.00	—	I4BB
16334	22.70	101.60	22.70	—	TDUO	13649	23.81	34.93	4.76	—	I4B.	12143	24.00	32.00	4.00	—	I4BA
16312	22.70	106.60	22.70	—	TDUO	—	23.81	34.93	6.35	—	I4BA	12143	24.00	32.00	4.00	—	I4BA
16330	22.70	120.65	22.70	—	TDUO	17451	23.81	34.93	6.35	—	I5BB	20969	24.00	32.00	4.00	—	I5BA
16742	22.70	152.40	22.70	—	TDUO	16228	23.81	34.93	6.35	—	I2BB	—	24.00	32.00	7.00	—	I4BB
—	23.00	34.00	6.00	—	I2BB	20957	23.81	34.93	7.54	—	I5BA	11353	24.00	32.00	7.00	—	I2BA
—	23.00	35.00	6.00	—	I2BB	15777	23.81	34.93	9.52	—	I5BB	11066	24.00	33.00	5.50	—	I2BA
—	23.00	35.00	6.50	—	I5BB	—	23.81	36.51	6.35	—	I4BB	16924	24.00	34.00	6.00	—	I5BB
—	23.00	35.00	6.50	—	I5BB	13433	23.81	36.51	6.35	—	I5BA	11128	24.00	34.00	7.00	—	I5BB
13066	23.00	35.00	7.00	—	I5B.	18048	23.81	36.51	7.94	—	I5BB	—	24.00	35.00	5.00	—	I4BA
20948	23.00	35.00	7.50	—	I5BB	13910	23.81	36.51	9.52	—	I5BA	20064	24.00	35.00	6.00	—	I5BB
—	23.00	35.00	8.00	—	I2BA	—	23.81	36.51	9.92	—	I5C	—	24.00	35.00	7.00	—	I4BA
—	23.00	35.00	8.00	—	I5BA	17520	23.81	38.10	6.35	—	I4BA	—	24.00	35.00	7.00	—	I2BB
16989	23.00	35.00	8.00	—	I2BA	17520	23.81	38.10	6.35	—	I4B.	20197	24.00	35.00	7.00	—	I4B.
22468	23.00	35.00	8.00	—	I5BB	13407	23.81	38.10	6.35	—	I5BB	12498	24.00	35.00	7.00	—	I5BB
—	23.00	35.00	8.00	—	I2BA	20959	23.81	38.10	6.35	—	I2BA	20970	24.00	35.00	7.00	—	I5BA
S2247	23.00	35.00	8.00	—	I2BB	15929	23.81	38.10	7.94	—	F	12498	24.00	35.00	7.00	—	I7BB
—	23.00	36.50	6.30	—	I5BA	13042	23.81	38.10	7.94	—	I5B.	16416	24.00	35.00	8.00	—	I2BA
—	23.00	38.00	7.50	—	I4BA	20960	23.81	38.10	7.94	—	I5BA	13083	24.00	36.00	6.00	—	I5BB
—	23.00	38.00	7.50	—	I13	13042	23.81	38.10	7.94	—	I5B.	—	24.00	36.00	6.00	—	I2BB
—	23.00	40.00	5.00	—	I4BB	20961	23.81	38.10	9.13	—	I5BB	13083	24.00	36.00	6.00	—	I5BB
11878	23.00	40.00	5.00	—	I4BA	17994	23.81	38.10	9.50	—	F	13083	24.00	36.00	6.00	—	I5BB
20949	23.00	40.00	6.00	—	I5BB	17119	23.81	38.10	9.92	—	I5BB	13083	24.00	36.00	6.00	—	I5BA
13071	23.00	40.00	6.00	—	I2BB	17119	23.81	38.10	9.92	—	I5B.	—	24.00	36.00	7.00	—	I2BB
20189	23.00	40.00	6.00	—	I2BB	—	23.81	38.10	11.11	—	I4BA	20971	24.00	36.00	9.00	—	I5BA
12069	23.00	40.00	8.00	—	I5BB	17919	23.81	38.10	11.11	—	ESPE	16447	24.00	36.00	9.00	—	I2BA
11112	23.00	40.00	10.00	—	I5BB	17919	23.81	38.10	11.11	—	ESPE	20972	24.00	36.00	10.00	—	I5BB
17054	23.00	40.00	10.00	—	I2BB	14842	23.81	38.10	12.70	—	I2BC	14206	24.00	36.00	10.00	—	I5BA
17054	23.00	40.00	10.00	—	I2BA	—	23.81	39.29	6.35	—	I4BB	13752	24.00	36.50	8.00	—	I5BA
20950	23.00	40.00	10.00	—	I5B.	—	23.81	39.69	6.35	—	I13	—	24.00	37.00	4.80	—	I2BB
17054	23.00	40.00	10.00	—	I2B.	14662	23.81	39.69	6.35	—	I13	—	24.00	37.00	7.00	—	I2BB



# Retentores

Perfis - Ver Última Página



INCOVE VEDAÇÕES LTDA.

Cod.	Di	De	Ha1	Ha2	Mod	Cod.	Di	De	Ha1	Ha2	Mod	Cod.	Di	De	Ha1	Ha2	Mod
13610	24.00	37.00	7.00	—	15BB	20989	24.61	38.10	7.94	—	15BB	14211	25.00	35.00	7.00	—	15BA
13610	24.00	37.00	7.00	—	12BB	20990	24.61	38.10	7.94	—	15B.	14211	25.00	35.00	7.00	—	15BB
13610	24.00	37.00	7.00	—	15BB	13177	24.61	39.92	7.94	—	12BA	12077	25.00	35.00	7.00	—	12BB
20973	24.00	37.00	7.00	—	15BA	18430	24.61	40.08	9.52	—	15BB	13354	25.00	35.00	7.00	—	12BB
20975	24.00	37.00	7.00	—	15BA	20991	24.61	41.28	7.94	—	15B.	12077	25.00	35.00	7.00	—	12BB
20974	24.00	37.00	7.00	—	15B.	12920	24.61	41.28	9.52	—	12BB	12077	25.00	35.00	7.00	—	12BB
20976	24.00	38.00	8.00	—	12BB	—	24.61	42.86	7.94	—	14BA	14211	25.00	35.00	7.00	—	15B.
20977	24.00	38.00	9.00	—	15BB	20992	24.61	42.86	7.94	—	15BA	—	25.00	35.00	7.00	—	17B.
20978	24.00	38.00	10.00	—	15B.	15975	24.61	42.86	7.94	—	15B	14211	25.00	35.00	7.00	—	15B.
16648	24.00	38.00	11.00	—	ESPE	18431	24.61	44.45	6.35	—	14BB	12611	25.00	35.00	7.00	—	17BB
16400	24.00	38.10	10.00	—	12B.	16397	24.61	44.45	7.94	—	12BA	12077	25.00	35.00	7.00	—	12BB
17119	24.00	38.25	9.00	—	15BB	20993	24.61	44.45	7.94	—	12BA	—	25.00	35.00	7.50	—	12BA
17119	24.00	38.25	9.00	—	15B.	17964	24.61	44.45	9.52	—	15BB	12244	25.00	35.00	7.50	—	12BA
16011	24.00	40.00	5.00	—	14BB	16387	24.61	44.45	9.92	—	15BA	12244	25.00	35.00	7.50	—	12BA
20979	24.00	40.00	6.00	—	15BB	17120	24.61	44.45	15.87	—	11FC	—	25.00	35.00	8.00	—	12BB
—	24.00	40.00	7.00	—	12BB	17120	24.61	44.45	15.87	—	11BF	12181	25.00	35.00	8.00	—	15BB
—	24.00	40.00	7.00	—	12BB	15493	24.61	46.43	11.11	—	15B.	20998	25.00	35.00	8.00	—	15B.
16925	24.00	40.00	7.00	—	15BB	18428	24.61	46.43	19.05	—	19B.	12181	25.00	35.00	8.00	—	15BB
20980	24.00	40.00	7.00	—	15BA	18428	24.61	46.43	19.05	—	19C	11777	25.00	35.00	9.00	—	12BA
—	24.00	40.00	8.00	—	15BB	20994	24.61	46.83	11.11	—	15BB	12959	25.00	35.00	9.50	—	14BB
—	24.00	40.00	8.00	—	12BB	15365	24.61	52.39	11.11	—	15BA	12959	25.00	35.00	9.50	—	14BA
20981	24.00	40.00	10.00	—	15B.	15365	24.61	52.39	11.11	—	15B.	—	25.00	35.00	10.00	—	12BA
—	24.00	41.00	8.50	—	12BB	15365	24.61	52.39	11.11	—	15C	—	25.00	35.00	10.00	—	12BB
16638	24.00	41.20	9.50	—	15BB	—	24.61	68.62	9.53	—	113	14169	25.00	35.00	10.00	—	12BA
—	24.00	42.00	8.00	—	12BB	16700	24.80	44.45	7.90	—	15BB	14212	25.00	35.00	10.00	—	15BB
13494	24.00	42.00	10.00	—	15BB	20095	24.80	44.45	7.90	—	12BB	14212	25.00	35.00	10.00	—	15BA
13494	24.00	42.00	10.00	—	15BB	—	25.00	30.00	8.00	—	14BA	21000	25.00	35.00	10.00	—	15BA
—	24.00	43.00	6.00	—	12BB	16428	25.00	32.00	4.00	—	14BB	20999	25.00	35.00	10.00	—	12BA
—	24.00	43.00	8.00	—	12BA	12144	25.00	32.00	4.00	—	14BA	—	25.00	35.00	13.00	—	17B.
12461	24.00	44.00	9.00	—	14BA	—	25.00	32.00	4.00	—	14BB	22478	25.00	35.50	10.00	—	15TG
12641	24.00	44.00	9.00	—	14BA	12144	25.00	32.00	4.00	—	14BB	17449	25.00	36.00	6.00	—	15BB
—	24.00	45.00	7.00	—	12BB	12144	25.00	32.00	4.00	—	14BA	17449	25.00	36.00	6.00	—	15BB
13563	24.00	45.00	8.00	—	15BA	12144	25.00	32.00	4.00	—	14BB	11469	25.00	36.00	6.00	—	12BA
20983	24.00	45.00	14.00	—	15BB	16688	25.00	32.00	5.00	—	14BA	11469	25.00	36.00	6.00	—	12BB
12348	24.00	46.00	6.50	10.00	ESPE	—	25.00	32.00	5.00	—	14BA	14213	25.00	36.00	7.00	—	15BB
—	24.00	46.00	8.00	—	12BB	20995	25.00	32.00	7.00	—	15BB	14213	25.00	36.00	7.00	—	15BB
14207	24.00	46.00	10.00	—	15BB	14208	25.00	32.00	7.00	—	15BA	14213	25.00	36.00	7.00	—	15BB
—	24.00	47.00	7.00	—	12BB	16868	25.00	32.00	7.00	—	12BA	14213	25.00	36.00	7.00	—	15BA
14228	24.00	47.00	7.00	—	15BB	14208	25.00	32.00	7.00	—	15B.	13607	25.00	36.00	7.00	—	12BB
20984	24.00	47.00	7.00	—	15BB	14208	25.00	32.00	8.00	—	15BB	14213	25.00	36.00	7.00	—	15B.
20985	24.00	47.00	7.00	—	15BA	13619	25.00	32.00	8.00	—	12BB	14213	25.00	36.00	7.00	—	15BA
—	24.00	47.00	10.00	—	12BB	—	25.00	32.00	10.00	—	14BA	13500	25.00	36.00	8.00	—	14BB
14168	24.00	47.00	10.00	—	15BB	12145	25.00	33.00	4.00	—	14BA	13492	25.00	36.00	8.00	—	15BB
20986	24.00	47.00	10.00	—	15BA	20097	25.00	33.00	6.00	—	15BB	13492	25.00	36.00	9.00	—	15BB
14168	24.00	47.00	10.00	—	15B.	20097	25.00	33.00	6.00	—	12BB	17449	25.00	36.50	6.00	—	15BB
13883	24.00	47.00	12.00	—	15BA	14209	25.00	33.00	7.00	—	12BA	13894	25.00	37.00	5.00	—	15BB
—	24.00	48.00	7.00	—	12BB	14209	25.00	33.00	7.00	—	12B.	—	25.00	37.00	6.00	—	12BB
—	24.00	50.00	8.00	—	12BB	13832	25.00	33.00	9.00	—	15BA	—	25.00	37.00	7.00	—	15BA
11124	24.00	50.00	10.00	—	15BB	12612	25.00	34.00	5.00	—	14BA	—	25.00	37.00	7.00	—	12BB
13524	24.00	52.00	7.00	—	15BA	20064	25.00	34.00	6.00	—	15BB	21002	25.00	37.00	7.00	—	15BB
13524	24.00	52.00	7.00	—	15BA	12146	25.00	35.00	4.00	—	14BA	14214	25.00	37.00	7.00	—	15BB
—	24.00	52.00	8.00	—	12BB	20996	25.00	35.00	4.50	—	15BB	21002	25.00	37.00	7.00	—	15BB
—	24.00	52.00	10.00	—	12BB	—	25.00	35.00	5.00	—	12BB	14214	25.00	37.00	7.00	—	15BA
20987	24.00	52.00	12.00	—	15B.	14210	25.00	35.00	5.00	—	14BA	13610	25.00	37.00	7.00	—	15B.
—	24.00	62.00	6.50	—	12BB	—	25.00	35.00	5.00	—	14BA	14214	25.00	37.00	7.00	—	15B.
14871	24.00	62.00	12.00	3.00	ESPE	14210	25.00	35.00	5.00	—	14B.	21003	25.00	37.00	7.50	—	15BB
13789	24.00	80.00	12.00	—	15UO	12537	25.00	35.00	5.00	—	15BB	16071	25.00	37.00	7.50	—	12BB
11816	24.00	90.00	36.00	—	TDUO	20997	25.00	35.00	5.00	—	15BB	13938	25.00	37.00	8.00	—	15BB
20260	24.20	44.45	8.73	—	15BB	25358	25.00	35.00	6.00	6.50	12BB	13938	25.00	37.00	8.00	—	15BB
—	24.21	46.43	14.68	—	19B	11872	25.00	35.00	6.00	—	15BB	21004	25.00	37.00	9.00	—	15BA
—	24.50	40.00	8.40	—	15BB	12077	25.00	35.00	7.00	—	12BB	—	25.00	38.00	6.00	—	14BB
—	24.50	47.00	7.00	—	12BB	14211	25.00	35.00	7.00	—	15BB	—	25.00	38.00	6.40	—	15BB
16710	24.50	47.00	10.00	—	11FB	14211	25.00	35.00	7.00	—	15BB	—	25.00	38.00	7.00	—	12BB
13893	24.50	54.00	9.50	—	19B.	14211	25.00	35.00	7.00	—	15BA	—	25.00	38.00	7.00	—	12BB
14875	24.60	46.40	14.70	—	19B.	13369	25.00	35.00	7.00	—	15BB	—	25.00	38.00	7.00	—	12BB
18338	24.61	38.10	6.35	—	14BB	13369	25.00	35.00	7.00	—	15BA	12229	25.00	38.00	7.00	—	12BB
—	24.61	38.10	6.35	—	14BA	13369	25.00	35.00	7.00	—	15BB	14215	25.00	38.00	7.00	—	15BB



# Retenfores

Perfis - Ver Última Página



INCOVE VEDAÇÕES LTDA.

Cod.	Di	De	Ha1	Ha2	Mod	Cod.	Di	De	Ha1	Ha2	Mod	Cod.	Di	De	Ha1	Ha2	Mod
12229	25.00	38.00	7.00	—	I2BB	14059	25.00	42.00	6.00	—	I5BB	13536	25.00	45.00	16.00	—	I5BB
14215	25.00	38.00	8.00	—	I5B.	14059	25.00	42.00	6.00	—	I5BA	—	25.00	46.00	5.00	—	I4BA
21006	25.00	38.00	8.00	—	I5BA	14059	25.00	42.00	6.00	—	I5BB	14226	25.00	46.00	5.00	—	I4B.
13440	25.00	38.00	8.00	—	I2BB	21115	25.00	42.00	7.00	—	I5BB	20257	25.00	46.00	7.00	—	I5BB
14215	25.00	38.00	8.00	—	I5B.	21115	25.00	42.00	7.00	—	I5BB	21035	25.00	46.00	7.50	—	I5BB
21007	25.00	38.00	8.33	—	I2B.	21031	25.00	42.00	7.00	—	I2BB	14227	25.00	46.00	10.00	—	I5BA
16442	25.00	38.00	9.80	—	I2BB	21022	25.00	42.00	7.00	—	I5BA	—	25.00	46.00	10.00	—	I1FB
14216	25.00	38.00	12.00	—	I5BB	20322	25.00	42.00	7.00	—	I5TG	20258	25.00	46.00	14.00	—	I7BB
13111	25.00	38.00	12.00	17.00	I2BB	—	25.00	42.00	8.00	—	I5BB	—	25.00	47.00	5.00	—	I4BB
14216	25.00	38.00	12.00	—	I5BA	14220	25.00	42.00	8.00	—	I5BA	12233	25.00	47.00	7.00	—	I2BA
—	25.00	38.05	8.00	—	I5BA	14220	25.00	42.00	8.00	—	I5BB	14228	25.00	47.00	7.00	—	I5BB
13101	25.00	39.00	5.00	—	I5JM	14220	25.00	42.00	8.00	—	I5BA	14228	25.00	47.00	7.00	—	I5BA
21008	25.00	40.00	5.00	—	I5BB	16612	25.00	42.00	9.00	—	I5BA	12233	25.00	47.00	7.00	—	I2BB
—	25.00	40.00	5.00	—	I2BB	16612	25.00	42.00	9.00	—	I5B.	12233	25.00	47.00	7.00	—	I2BA
13121	25.00	40.00	5.00	—	I4BB	14221	25.00	42.00	10.00	—	I5BB	11287	25.00	47.00	7.00	—	I7BB
13121	25.00	40.00	5.00	—	I4BB	21023	25.00	42.00	10.00	—	I5BA	14228	25.00	47.00	7.00	—	I2BB
—	25.00	40.00	5.00	—	I4BA	14221	25.00	42.00	10.00	—	I5B.	—	25.00	47.00	8.00	—	I2BA
—	25.00	40.00	5.00	—	I13	16733	25.00	42.00	10.00	—	I2BB	11863	25.00	47.00	8.00	—	I4BB
14217	25.00	40.00	5.00	—	I13	21024	25.00	42.00	10.00	—	I2BA	20413	25.00	47.00	8.00	—	I2BA
13751	25.00	40.00	5.00	—	I5BA	16733	25.00	42.00	10.00	—	I2BB	21036	25.00	47.00	9.00	—	I5B.
13864	25.00	40.00	5.50	—	I4BA	16511	25.00	42.86	9.53	—	I5BB	—	25.00	47.00	10.00	—	I2BB
21009	25.00	40.00	6.00	—	I5BA	21025	25.00	42.86	9.53	—	I5BA	14229	25.00	47.00	10.00	—	I5BB
20331	25.00	40.00	6.00	—	I2BA	—	25.00	43.00	8.00	—	I2BB	12272	25.00	47.00	10.00	—	I2BB
21010	25.00	40.00	6.50	—	I5BB	21026	25.00	43.00	8.00	—	I5BA	14229	25.00	47.00	10.00	—	I5BB
11267	25.00	40.00	7.00	—	I2BB	14222	25.00	43.00	10.00	—	I5BB	14229	25.00	47.00	10.00	—	I5JL
14218	25.00	40.00	7.00	—	I5BA	—	25.00	43.00	10.00	—	I2BB	21037	25.00	47.00	10.00	—	I5BA
14172	25.00	40.00	7.00	—	I13	14222	25.00	43.00	10.00	—	I5BB	14229	25.00	47.00	10.00	—	I5B.
14218	25.00	40.00	7.00	—	I5BB	14222	25.00	43.00	10.00	—	I5BA	12272	25.00	47.00	10.00	—	I2BB
14218	25.00	40.00	7.00	—	I5BA	14222	25.00	43.00	10.00	—	I5BB	12272	25.00	47.00	10.00	—	I2BA
11267	25.00	40.00	7.00	—	I2BB	14222	25.00	43.00	10.00	—	I5BA	14229	25.00	47.00	10.00	—	I5BA
11217	25.00	40.00	8.00	—	I2BB	14222	25.00	43.00	10.00	—	I5B.	12272	25.00	47.00	10.00	—	I2BA
18436	25.00	40.00	8.00	—	I5BB	21027	25.00	43.00	10.00	—	I2BB	—	25.00	47.00	13.00	—	I2BB
11217	25.00	40.00	8.00	—	I2BB	—	25.00	43.00	10.00	—	I3BC	—	25.00	48.00	8.00	—	I2BB
21011	25.00	40.00	8.00	—	I5BB	17925	25.00	43.66	11.10	—	I5BA	16437	25.00	48.00	8.00	—	I5BB
21012	25.00	40.00	8.00	—	I5BA	17925	25.00	43.66	11.10	—	I3B	21038	25.00	48.00	12.00	—	I5BB
11217	25.00	40.00	8.00	—	I2BB	12462	25.00	44.00	4.70	—	I4BA	14230	25.00	48.00	12.00	—	I5BA
11217	25.00	40.00	8.00	—	I2BA	—	25.00	44.00	7.00	—	I2BB	20399	25.00	49.00	6.00	—	I2BB
—	25.00	40.00	8.00	—	I2BB	12504	25.00	44.00	7.00	—	I5BB	—	25.00	50.00	7.00	—	I2BB
18436	25.00	40.00	8.00	—	I5C	11676	25.00	44.00	8.00	—	I2BB	25381	25.00	50.00	7.00	—	I2BB
11575	25.00	40.00	9.00	—	I2BB	21028	25.00	44.00	8.00	—	I5BB	13937	25.00	50.00	9.00	—	I5BB
11575	25.00	40.00	9.00	—	I2BB	—	25.00	44.00	9.80	—	I7B.	—	25.00	50.00	10.00	—	I2BB
21013	25.00	40.00	9.00	—	I5B.	21029	25.00	44.00	10.00	—	I5BA	14231	25.00	50.00	10.00	—	I5BB
11578	25.00	40.00	9.00	—	I7BB	13698	25.00	44.00	11.00	—	I5BB	21039	25.00	50.00	10.00	—	I5BA
—	25.00	40.00	10.00	—	I2BB	15079	25.00	44.45	8.33	—	VICK	14231	25.00	50.00	10.00	—	I5B.
14219	25.00	40.00	10.00	—	I5BB	14880	25.00	45.00	5.00	—	I5BB	17414	25.00	50.00	10.00	—	I2BA
14219	25.00	40.00	10.00	—	I5B.	11748	25.00	45.00	5.00	—	I4BA	14231	25.00	50.00	10.00	—	I5BB
14219	25.00	40.00	10.00	—	I5JM	14880	25.00	45.00	5.00	—	I5BB	—	25.00	50.00	12.00	—	I5BB
14219	25.00	40.00	10.00	—	I5BB	RU28	25.00	45.00	6.00	—	I5BB	14233	25.00	50.00	12.00	—	I5BB
21015	25.00	40.00	10.00	—	I5BB	—	25.00	45.00	7.00	—	I2BB	14233	25.00	50.00	12.00	—	I5B.
21014	25.00	40.00	10.00	—	I5BA	14223	25.00	45.00	7.00	—	I5BA	14233	25.00	50.00	12.00	—	I5BB
21016	25.00	40.00	10.00	—	I5B.	14223	25.00	45.00	7.00	—	I5BB	14234	25.00	52.00	6.00	—	I5BB
14219	25.00	40.00	10.00	—	I5C	20824	25.00	45.00	8.00	—	I2BA	21040	25.00	52.00	6.00	—	I5BA
21017	25.00	40.00	12.00	—	I5BB	25428	25.00	45.00	8.00	—	I5BB	14234	25.00	52.00	6.00	—	I5B.
14666	25.00	40.00	12.00	—	I5BB	11007	25.00	45.00	10.00	—	I2BA	—	25.00	52.00	7.00	—	I5BB
22567	25.00	40.00	—	—	I5BB	—	25.00	45.00	10.00	—	I5BB	16166	25.00	52.00	7.00	—	I5BB
21018	25.00	40.48	8.33	—	I2BB	—	25.00	45.00	10.00	—	I2BB	16166	25.00	52.00	7.00	—	I5B
—	25.00	41.00	8.00	—	I2BB	—	25.00	45.00	10.00	—	I5BA	11524	25.00	52.00	7.00	—	I5BA
11689	25.00	41.00	14.00	—	ESPE	14224	25.00	45.00	10.00	—	I5BB	14235	25.00	52.00	7.00	—	I13
13267	25.00	41.15	9.50	—	I5BB	21030	25.00	45.00	10.00	—	I5BA	11164	25.00	52.00	7.00	8.50	I2BB
—	25.00	41.17	9.52	—	I5BB	14224	25.00	45.00	10.00	—	I5B.	21041	25.00	52.00	7.00	—	I2BA
21021	25.00	41.28	9.53	—	I5BB	11007	25.00	45.00	10.00	—	I2BB	12657	25.00	52.00	8.00	—	I2BB
21019	25.00	41.28	9.53	—	I5BA	11007	25.00	45.00	10.00	—	I2B	—	25.00	52.00	8.00	—	I2BB
21020	25.00	41.28	9.53	—	I5B.	11558	25.00	45.00	11.00	—	I5BB	14235	25.00	52.00	8.00	—	I13
—	25.00	41.40	6.00	—	I2BB	21032	25.00	45.00	12.00	—	I5BB	13525	25.00	52.00	8.00	—	I5BB
RU17	25.00	41.55	10.80	—	I2B.	21033	25.00	45.00	14.00	—	I5BB	13525	25.00	52.00	8.00	—	I5BB
14059	25.00	42.00	6.00	—	I2BB	21034	25.00	45.00	14.00	—	I5B.	21042	25.00	52.00	8.00	—	I5BA
14059	25.00	42.00	6.00	—	I5BB	14225	25.00	45.00	14.00	—	I7B.	12657	25.00	52.00	8.00	—	I2BB



# Retentores

Perfis - Ver Última Página



INCOVE VEDAÇÕES LTDA.

Cod.	Di	De	Ha1	Ha2	Mod	Cod.	Di	De	Ha1	Ha2	Mod	Cod.	Di	De	Ha1	Ha2	Mod
12657	25.00	52.00	8.00	—	I2BB	15249	25.40	31.75	3.17	—	I4BA	13317	25.40	38.10	7.94	—	I5B.
14236	25.00	52.00	10.00	—	I5BB	15249	25.40	31.75	3.17	—	I4BA	13440	25.40	38.10	7.94	—	I2B.
—	25.00	52.00	10.00	—	I5BB	—	25.40	31.75	3.20	—	I4BA	13440	25.40	38.10	7.94	—	I2BB
—	25.00	52.00	10.00	—	I2BB	16054	25.40	31.75	6.35	—	I5BB	13440	25.40	38.10	7.94	—	I2BA
14236	25.00	52.00	10.00	—	I5BB	12672	25.40	31.75	11.11	—	I5BA	13317	25.40	38.10	7.94	—	I5C
12312	25.00	52.00	10.00	12.70	ESPE	14762	25.40	33.34	3.17	—	I4BA	21063	25.40	38.10	8.73	—	I2BA
21043	25.00	52.00	10.00	—	I5BB	21056	25.40	33.34	5.95	—	I5BB	15417	25.40	38.10	9.52	—	I5BA
14236	25.00	52.00	10.00	—	I5BA	14721	25.40	34.93	4.76	—	I4BA	18216	25.40	38.10	9.52	—	I2BA
14236	25.00	52.00	10.00	—	I5B	—	25.40	34.93	4.76	—	I4BA	16970	25.40	38.10	9.52	—	I4BB
14236	25.00	52.00	10.00	—	I5B.	14721	25.40	34.93	4.76	—	I4BA	15417	25.40	38.10	9.52	—	I5BB
14636	25.00	52.00	10.00	—	I5BA	21057	25.40	34.93	4.76	—	I5BA	18216	25.40	38.10	9.52	—	I2BA
11165	25.00	52.00	10.00	11.00	I7BB	—	25.40	34.93	5.16	—	I4BA	15417	25.40	38.10	9.52	—	I5B.
11660	25.00	52.00	11.00	—	I5BB	12270	25.40	34.93	6.35	—	I5BA	18216	25.40	38.10	9.52	—	I2BB
11660	25.00	52.00	11.00	—	I5BB	15472	25.40	34.93	6.35	—	F	15417	25.40	38.10	9.52	—	I5C
21045	25.00	52.00	12.00	—	I5BB	—	25.40	34.93	6.35	—	I4BB	21066	25.40	38.10	9.92	—	I5BA
14237	25.00	52.00	12.00	—	I5B.	12270	25.40	34.93	6.35	—	I5BA	—	25.40	38.10	11.11	—	I1FB
14237	25.00	52.00	12.00	—	I5C	11594	25.40	34.93	8.73	—	I5BB	13438	25.40	38.10	12.70	—	I2B.
—	25.00	52.00	15.00	—	ESPE	21058	25.40	34.93	9.35	—	I5BB	13438	25.40	38.10	12.70	—	I2B.
16843	25.00	52.00	19.30	—	I2BA	14169	25.40	34.93	9.52	—	I2BA	—	25.40	38.10	14.29	—	I2C
20022	25.00	54.00	10.00	—	I2B.	19993	25.40	34.93	12.70	—	I7B.	17079	25.40	38.10	15.87	—	I1FB
13528	25.00	54.00	15.00	—	I5BA	21059	25.40	35.72	6.35	—	I5BA	17079	25.40	38.10	15.87	—	I1FC
—	25.00	55.00	7.00	—	I5BA	—	25.40	36.37	7.90	—	I4BB	—	25.40	38.10	18.26	—	I7C
13582	25.00	55.00	8.00	—	I2BB	—	25.40	36.50	6.35	—	I2BB	17331	25.40	38.10	19.05	—	I7C
21046	25.00	55.00	9.00	—	I5BB	16193	25.40	36.50	7.90	—	I5BA	19969	25.40	38.11	11.11	—	I2B.
20069	25.00	55.00	10.00	—	I2BB	—	25.40	36.51	4.76	—	I4BA	13839	25.40	38.18	11.11	—	I4BA
12657	25.00	58.00	8.00	—	I2BB	17449	25.40	36.51	6.35	—	I5BB	17223	25.40	38.50	5.55	—	I4BA
14239	25.00	58.00	10.00	—	I5BB	17449	25.40	36.51	6.35	—	I5BA	18328	25.40	38.50	13.49	—	ESPE
12494	25.00	60.00	7.00	—	I5BA	18243	25.40	36.51	6.35	—	I2BB	12582	25.40	38.70	5.50	—	I55B
—	25.00	60.00	8.00	—	I2BB	18243	25.40	36.51	6.35	—	I2BA	16802	25.40	39.00	4.76	—	I4BA
—	25.00	62.00	7.00	—	I2BB	18243	25.40	36.51	6.35	—	I2B.	19968	25.40	39.30	9.20	—	ESPE
14095	25.00	62.00	7.00	—	I13	21060	25.40	36.51	6.50	—	I5BA	19968	25.40	39.30	9.20	—	ESPE
22586	25.00	62.00	7.00	—	I5BB	15537	25.40	36.51	7.00	—	I5BA	—	25.40	39.65	6.35	—	I4BA
21048	25.00	62.00	8.00	—	I5BB	15537	25.40	36.51	7.94	—	I5BB	16607	25.40	39.69	4.76	—	I4BA
21047	25.00	62.00	8.00	—	I5BA	—	25.40	36.51	7.94	—	I4BA	—	25.40	39.69	5.16	—	I4BA
12983	25.00	62.00	8.00	—	I2BB	14767	25.40	36.51	7.94	—	I4ES	18437	25.40	39.69	6.35	—	I5BB
—	25.00	62.00	10.00	—	I5BB	14767	25.40	36.51	7.94	—	I4BB	18437	25.40	39.69	6.35	—	I5BA
—	25.00	62.00	10.00	—	I2BB	18017	25.40	36.51	9.52	—	I5BB	11630	25.40	39.69	8.73	—	I5BB
—	25.00	62.00	10.00	13.00	I4BA	18017	25.40	36.51	9.52	—	I5BA	18436	25.40	39.69	9.52	—	I5BB
14241	25.00	62.00	10.00	—	I5B.	18017	25.40	36.51	9.52	—	I5C	18436	25.40	39.69	9.52	—	I5B.
14240	25.00	62.00	10.00	—	I5B.	—	25.40	36.53	4.82	—	I5BB	21068	25.40	39.69	9.53	—	I2BA
14240	25.00	62.00	10.00	—	I5BB	17449	25.40	36.60	6.50	—	I5BA	14073	25.40	39.69	57.15	—	REPA
14240	25.00	62.00	10.00	—	I5BB	—	25.40	37.00	7.50	—	I5BB	—	25.40	39.90	6.35	—	I4BA
14240	25.00	62.00	10.00	—	I5BB	25431	25.40	37.00	8.00	—	I2BB	18430	25.40	40.08	7.94	—	I5BB
14240	25.00	62.00	10.00	—	I5BB	18937	25.40	37.31	6.35	—	I5BB	12805	25.40	40.45	6.00	6.40	I2BB
21050	25.00	62.00	12.00	—	I5B.	—	25.40	38.00	6.50	—	I2BA	18316	25.40	40.48	7.94	—	I2B.
13030	25.00	62.00	13.00	—	I5C	—	25.40	38.07	6.35	—	I2BB	18316	25.40	40.48	7.94	—	I2BB
12983	25.00	65.00	8.00	—	I5BB	—	25.40	38.07	6.66	—	I2BA	20232	25.40	41.00	6.30	—	I2BB
20375	25.00	65.00	10.00	—	I5BB	—	25.40	38.07	9.50	—	I2BA	—	25.40	41.28	6.35	—	I4BA
12990	25.00	65.00	12.00	—	I2BB	—	25.40	38.07	9.92	—	I2BB	18438	25.40	41.28	6.35	—	I4B.
12986	25.00	65.00	14.00	—	I2BB	—	25.40	38.10	4.76	—	I4BA	RU07	25.40	41.28	6.35	—	I5BB
21051	25.00	70.00	13.00	—	I5BB	19910	25.40	38.10	4.76	—	I5BA	21069	25.40	41.28	6.35	—	I5BA
21052	25.00	72.00	10.00	—	I2BA	19910	25.40	38.10	4.76	—	I5BA	21071	25.40	41.28	7.94	—	I5BA
22435	25.00	72.00	10.00	—	I5BB	13298	25.40	38.10	6.35	—	I5BB	16603	25.40	41.28	7.94	—	I5B.
14242	25.00	72.00	12.00	—	I5B.	13595	25.40	38.10	6.35	12.70	I2B.	13267	25.40	41.28	9.52	—	I5B.
21054	25.00	75.00	5.50	—	I5BB	12793	25.40	38.10	6.35	—	I2BA	13267	25.40	41.28	9.52	—	I5BA
12983	25.00	75.00	8.00	—	I5BB	15222	25.40	38.10	6.35	—	I4BB	17920	25.40	41.28	9.52	—	ESP
11085	25.00	78.00	8.00	—	ESPE	15222	25.40	38.10	6.35	—	I4BA	13267	25.40	41.28	9.52	—	I5C
11643	25.00	89.00	9.00	—	I5BA	17545	25.40	38.10	6.35	—	F	—	25.40	41.28	9.53	—	I4BA
11729	25.00	160.00	40.00	—	TDUO	13298	25.40	38.10	6.35	—	I5B.	15093	25.40	41.28	11.11	—	I5B.
22547	25.00	200.00	40.00	—	TDUO	13298	25.40	38.10	6.35	—	I5BB	21073	25.40	41.28	11.11	—	I5BB
14023	25.10	44.20	10.00	—	I13	13298	25.40	38.10	6.35	—	I5BA	15093	25.40	41.28	11.11	—	I5BA
18980	25.10	44.20	10.00	—	I13	12793	25.40	38.10	6.35	7.94	I2BA	21072	25.40	41.28	11.11	—	I5B.
16709	25.30	52.00	19.30	—	I1FB	15222	25.40	38.10	6.35	—	I4C	15093	25.40	41.28	11.11	—	I5C
21055	25.40	24.86	9.53	—	I2BA	21062	25.40	38.10	6.50	—	I5B.	17739	25.40	41.28	15.87	—	I1FB
13061	25.40	30.96	3.17	—	I4BA	17068	25.40	38.10	7.94	—	I13	—	25.40	41.28	15.88	—	I1FC
13061	25.40	30.96	3.17	—	I4BA	—	25.40	38.10	7.94	—	I4BA	—	25.40	41.28	18.65	—	I9BA
15249	25.40	31.75	3.17	—	I4BB	13440	25.40	38.10	7.94	—	I2B.	17921	25.40	41.28	19.05	—	I9B.





# Retentores

Perfis - Ver Última Página



INCOVE VEDAÇÕES LTDA.

Cod.	Di	De	Ha1	Ha2	Mod	Cod.	Di	De	Ha1	Ha2	Mod	Cod.	Di	De	Ha1	Ha2	Mod
22474	25.40	41.35	6.35	—	I2BA	21088	25.40	46.43	9.53	—	I5B.	18435	25.40	57.15	11.11	—	I5B.
17283	25.40	42.07	11.11	—	I3B.	—	25.40	46.43	11.11	—	I5BB	21105	25.40	57.15	12.70	—	I5BB
17283	25.40	42.07	11.11	—	I3BC	21090	25.40	46.43	11.11	—	I5B.	—	25.40	57.15	14.29	—	I3B
21074	25.40	42.86	6.35	—	I5BB	21091	25.40	46.43	11.11	—	I2BA	15596	25.40	60.33	7.94	—	I5BA
15768	25.40	42.86	6.35	—	I5B.	21092	25.40	46.43	11.11	—	I2B.	—	25.40	61.91	7.94	—	I4BA
—	—	—	—	—	—	—	25.40	46.43	15.87	—	I2BB	—	25.40	61.91	7.94	—	I13
12767	25.40	42.86	7.94	—	I2BA	19996	25.40	46.43	15.87	—	I1FC	13107	25.40	61.91	7.94	—	I4BA
21075	25.40	42.86	7.94	—	I5BA	—	25.40	46.43	15.88	—	I1FC	17162	25.40	61.91	9.52	—	I13
14023	25.40	42.86	9.52	—	F	20199	25.40	46.80	4.70	—	I5BB	17973	25.40	71.44	29.37	—	I1BF
19911	25.40	42.86	9.52	—	I2B.	13736	25.40	46.83	4.76	—	I4JM	15205	25.40	74.61	9.52	—	ESPE
—	25.40	42.86	9.53	—	I5C	—	—	—	—	—	—	—	—	—	—	—	—
11641	25.40	43.00	8.00	—	I5B.	18433	25.40	46.83	4.76	—	I4BB	17456	25.40	82.55	11.91	—	I55
11476	25.40	43.00	8.00	—	I2BA	20199	25.40	46.83	4.76	—	I5BB	—	25.50	40.00	6.50	—	I5BB
11476	25.40	43.00	8.00	—	I2B.	15341	25.40	46.83	11.11	—	I5B.	—	25.50	40.00	7.00	—	I2BB
21076	25.40	43.26	7.54	—	I5BA	14056	25.40	46.83	11.11	—	I2BB	21106	25.80	38.10	7.70	—	I2BB
21077	25.40	43.26	7.94	—	I2BA	14056	25.40	46.83	11.11	—	I2B.	16487	25.80	43.70	9.00	—	I5BB
—	—	—	—	—	—	—	—	—	—	—	—	—	—	—	—	—	—
21078	25.40	43.26	9.53	—	I5B.	15341	25.40	46.83	11.11	—	I5C	—	25.80	52.39	3.97	—	I4BA
21079	25.40	43.26	11.11	—	I5BB	18981	25.40	47.63	6.35	—	I4B.	15697	25.80	52.39	3.97	—	I4B.
21080	25.40	43.60	11.11	—	I5C	21093	25.40	47.63	6.35	—	I5BB	—	26.00	31.00	3.00	—	I4BA
19932	25.40	43.66	7.94	—	I2BB	RU09	25.40	47.63	9.52	—	I5BB	11477	26.00	33.00	4.80	—	I4BA
18432	25.40	43.66	9.52	—	I5B	21094	25.40	47.63	9.53	—	I5B.	20325	26.00	33.50	4.00	—	I5BB
—	—	—	—	—	—	—	—	—	—	—	—	—	—	—	—	—	—
18432	25.40	43.66	9.52	—	I5C	17075	25.40	47.63	11.11	—	I5B.	12147	26.00	34.00	4.00	—	I4BA
11405	25.40	44.40	10.00	—	I5B.	21095	25.40	47.63	11.11	—	I5BB	—	26.00	34.00	5.00	—	I4BA
—	25.40	44.45	5.16	—	I4BB	17075	25.40	47.63	11.11	—	I5B.	S2259	26.00	34.00	5.00	—	I4BA
12582	25.40	44.45	5.50	—	I55B	17075	25.40	47.63	11.11	—	I5C	13070	26.00	34.00	8.00	—	I5BB
18431	25.40	44.45	6.35	—	I4BB	21096	25.40	47.63	17.46	—	I5BB	—	26.00	34.50	5.50	—	I2BB
—	—	—	—	—	—	—	—	—	—	—	—	—	—	—	—	—	—
18431	25.40	44.45	6.35	—	I4BA	—	25.40	47.63	17.46	—	I7B.	—	26.00	35.00	7.00	—	I2BB
13451	25.40	44.45	6.35	—	I5BB	18293	25.40	47.63	19.05	—	IIBF	21108	26.00	35.00	7.00	—	I5BA
20283	25.40	44.45	6.35	—	I2BA	17471	25.40	49.21	4.76	—	I4BA	16478	26.00	35.15	10.00	—	I2BB
13451	25.40	44.45	6.35	—	I5BB	21097	25.40	49.21	11.11	—	I5BB	21109	26.00	36.00	7.00	—	I5BB
13311	25.40	44.45	7.94	—	I5B.	17670	25.40	49.21	11.11	—	ESPE	21110	26.00	36.00	8.00	—	I5BA
—	—	—	—	—	—	—	—	—	—	—	—	—	—	—	—	—	—
13311	25.40	44.45	7.94	—	I5BB	21098	25.40	50.40	6.75	—	I5BA	—	26.00	37.00	7.00	—	I2BB
21081	25.40	44.45	8.33	—	I5BB	21099	25.40	50.40	7.94	—	I2BB	14243	26.00	37.00	7.00	—	I2BB
13889	25.40	44.45	9.52	—	I5BB	21100	25.40	50.40	11.51	—	I5BA	21112	26.00	37.00	7.00	—	I5BB
—	25.40	44.45	9.53	—	I7B.	18440	25.40	50.40	12.70	—	I5B.	11743	26.00	37.00	7.00	—	I5BA
21082	25.40	44.45	9.53	—	I2BA	18439	25.40	50.40	15.87	—	I1BF	14243	26.00	37.00	7.00	—	I2BA
—	—	—	—	—	—	—	—	—	—	—	—	—	—	—	—	—	—
21083	25.40	44.45	9.92	—	I5B.	13270	25.40	50.40	15.87	—	I5C	14243	26.00	37.00	7.00	—	I2BB
15069	25.40	44.45	11.11	—	I5B	—	25.40	50.40	15.88	—	I5C	14243	26.00	37.00	7.00	—	I2BA
15069	25.40	44.45	11.11	—	I5BA	—	25.40	50.80	6.35	—	I4BA	21111	26.00	37.00	7.00	—	I5B.
15069	25.40	44.45	11.11	—	I5BA	18442	25.40	50.80	6.35	—	I4B.	—	26.00	37.00	8.00	—	I2BB
15069	25.40	44.45	11.11	—	I5B.	13452	25.40	50.80	6.35	—	I5BB	16809	26.00	38.00	5.00	—	I2BB
—	—	—	—	—	—	—	—	—	—	—	—	—	—	—	—	—	—
15069	25.40	44.45	11.11	—	I5C	—	25.40	50.80	7.94	—	I8BB	13653	26.00	38.00	9.00	—	I2BA
17425	25.40	44.45	12.70	—	F	13271	25.40	50.80	9.52	—	I5JL	21113	26.00	38.00	9.00	—	I5B.
17120	25.40	44.45	14.29	—	I1FB	13271	25.40	50.80	9.52	—	I5BA	—	26.00	38.07	8.00	—	I2BA
17120	25.40	44.45	14.29	—	I1FC	13271	25.40	50.80	9.52	—	I5B.	16791	26.00	38.20	6.35	—	I5B.
—	25.40	44.45	14.29	—	I1FB	—	25.40	50.80	10.00	—	I5BB	13160	26.00	40.00	5.00	—	I4BB
—	—	—	—	—	—	—	—	—	—	—	—	—	—	—	—	—	—
14014	25.40	44.45	15.87	—	I2B.	13271	25.40	50.80	10.00	—	I5BA	—	26.00	40.00	5.00	—	I4BB
17940	25.40	44.45	15.87	—	I7B.	18934	25.40	50.80	11.11	—	I13	16677	26.00	40.00	5.00	—	I2BB
21084	25.40	44.45	15.88	—	I5BB	—	25.40	50.80	11.11	—	I4BA	—	26.00	40.00	8.00	—	I2BB
—	25.40	44.45	15.88	—	I2BC	21101	25.40	50.80	11.11	—	I5BB	—	26.00	40.00	8.00	—	I2BB
15802	25.40	44.45	16.67	—	I5B.	15100	25.40	50.80	12.70	—	I5BA	12351	26.00	40.00	10.00	—	I2BB
—	—	—	—	—	—	—	—	—	—	—	—	—	—	—	—	—	—
—	25.40	44.50	5.00	—	I5BB	11409	25.40	50.80	12.70	—	I5B.	13159	26.00	42.00	6.50	—	ESPE
—	25.40	44.50	5.00	—	I2BB	18441	25.40	50.80	12.87	—	I2B.	13159	26.00	42.00	6.50	10.00	ESPE
—	25.40	44.50	6.50	—	I2BA	18441	25.40	50.80	15.87	—	I2BB	—	26.00	42.00	7.00	—	I5BA
—	25.40	44.50	6.50	—	I2BA	18441	25.40	50.80	15.87	—	I2B.	—	26.00	42.00	8.00	—	I2BA
16198	25.40	44.50	7.94	—	I5BB	14051	25.40	50.80	15.87	—	I1BF	—	26.00	42.00	8.00	—	I2BB
—	—	—	—	—	—	—	—	—	—	—	—	—	—	—	—	—	—
—	25.40	44.50	11.11	—	I5BB	—	25.40	52.00	9.00	—	I13	—	26.00	42.00	8.00	—	I2BA
—	25.40	44.50	15.00	—	I2BA	21103	25.40	52.00	9.00	—	I5BA	—	26.00	42.00	8.00	9.00	ESPE
14669	25.40	44.60	6.30	—	I4BB	21102	25.40	52.00	9.00	—	I5B.	16880	26.00	42.00	8.00	—	I2BA
14668	25.40	44.60	6.30	—	I4BB	15297	25.40	52.39	3.97	—	I4B.	—	26.00	42.00	8.00	—	I2BB
15342	25.40	44.60	6.40	—	I5BB	14203	25.40	52.39	6.35	—	I5BB	21116	26.00	42.00	9.00	—	I5B.
—	—	—	—	—	—	—	—	—	—	—	—	—	—	—	—	—	—
15342	25.40	44.60	6.40	—	I4BB	14203	25.40	52.39	6.35	—	I5BB	13495	26.00	42.00	9.62	—	I2BB
21085	25.40	44.85	5.16	—	I5BB	21104	25.40	52.39	11.11	—	I5BB	17288	26.00	42.00	10.00	—	I2BB
18228	25.40	46.04	6.35	—	F	15365	25.40	52.39	11.11	—	I5BA	17288	26.00	42.00	10.00	—	I2BB
RU07	25.40	46.04	9.52	—	I	15365	25.40	52.39	11.11	—	I5B.	13495	26.00	42.00	10.00	—	I5BB
21086	25.40	46.43	4.76	—	I5BB	15365	25.40	52.39	11.11	—	I5C	13495	26.00	42.00	10.00	—	I5BA
—	—	—	—	—	—	—	—	—	—	—	—	—	—	—	—	—	—
21087	25.40	46.43	6.35	—	I5B.	16073	25.40	52.40	9.52	—	I2BA	17288	26.00	42.00	10.00	—	I5BA
21089	25.40	46.43	9.53	—	I5BA	18434	25.40	53.98	15.08	—	I12B	21117	26.00	42.00	10.00		





# Retentores

Perfis - Ver Última Página



INCOVE VEDAÇÕES LTDA.

Cod.	Di	De	Ha1	Ha2	Mod	Cod.	Di	De	Ha1	Ha2	Mod	Cod.	Di	De	Ha1	Ha2	Mod
13119	26.00	42.00	10.00	—	I2BB	13301	26.99	42.86	6.35	—	I5BA	21152	27.00	40.00	7.00	—	I5BB
13119	26.00	42.00	10.00	—	I5BB	21137	26.99	42.86	7.14	—	I5BB	13212	27.00	40.00	7.00	—	I2BB
14244	26.00	43.00	10.00	—	I5BA	21136	26.99	42.86	7.14	—	I5BA	21153	27.00	40.00	7.00	—	I5BA
21118	26.00	43.00	10.00	—	I5BB	15295	26.99	42.86	7.94	—	I4BA	21152	27.00	40.00	7.00	—	I2BB
14244	26.00	43.00	10.00	—	I5BA	14857	26.99	42.86	7.94	—	I2BA	17566	27.00	40.00	8.00	—	I5B.
12208	26.00	45.00	10.00	—	I5BA	15256	26.99	42.86	9.52	—	I5BB	14248	27.00	41.00	10.00	—	I5BB
12208	26.00	45.00	10.00	—	I5BA	15256	26.99	42.86	9.52	—	I5B.	—	27.00	41.00	10.00	—	I2BB
12208	26.00	45.00	10.00	—	I5BA	12097	26.99	42.86	9.52	—	I2JM	14248	27.00	41.00	10.00	—	I5BB
—	26.00	47.00	6.30	—	I2BB	15856	26.99	43.66	9.52	—	I5BB	14248	27.00	41.00	10.00	—	I5C
12045	26.00	47.00	7.00	—	I5BB	—	26.99	44.45	4.76	—	I4BA	21162	27.00	42.00	7.00	—	I5BA
21119	26.00	47.00	7.00	—	I5BA	17941	26.99	44.45	4.76	—	I4B.	14249	27.00	42.00	10.00	—	I5BB
21120	26.00	47.00	10.00	—	I5BB	12795	26.99	44.45	9.52	—	I5B.	—	27.00	42.00	10.00	—	I2BB
—	26.00	50.00	8.00	—	I2BB	15059	26.99	44.45	11.11	—	F	14249	27.00	42.00	10.00	—	I5BB
21121	26.00	50.00	10.00	—	I5BB	21139	26.99	44.45	11.11	—	I5B.	14249	27.00	42.00	10.00	—	I5BB
14245	26.00	50.00	10.00	—	I5BA	17744	26.99	44.45	11.11	—	I5B.	21154	27.00	42.00	10.00	—	I2BB
—	26.00	52.00	8.00	—	I2BB	17942	26.99	45.24	7.94	—	I13	14857	27.00	42.70	7.90	—	I5BA
13158	26.00	52.00	8.00	—	I5BA	16068	26.99	46.04	8.33	—	I2BB	—	27.00	42.82	6.35	—	I5BB
21122	26.00	52.00	10.00	—	I5BB	15919	26.99	46.04	11.11	—	ESPE	—	27.00	42.82	9.52	—	I5BB
11779	26.00	52.00	12.00	—	I2B.	21140	26.99	46.43	6.35	—	I5BB	—	27.00	43.00	7.00	—	I2BB
13608	26.00	55.50	11.00	—	I5BA	18985	26.99	46.43	6.35	—	I5B.	—	27.00	43.00	9.00	—	I2BB
16402	26.00	76.50	16.00	—	DISC	21141	26.99	46.43	11.11	—	I5B.	13496	27.00	43.00	10.00	—	I5BB
—	26.19	33.34	3.18	—	I4BB	18982	26.99	47.63	6.35	—	I4BB	13496	27.00	43.00	10.00	—	I5C
—	26.19	33.34	3.18	—	I4BA	—	26.99	47.63	6.35	—	I4BA	16690	27.00	43.50	11.00	—	I5C
21123	26.19	38.10	9.92	—	I5BB	21142	26.99	47.63	9.53	—	I5BB	—	27.00	43.97	9.12	—	I5BB
21124	26.19	40.08	7.94	—	I5BB	15590	26.99	47.63	11.11	—	I5BB	—	27.00	44.40	9.52	—	I5BB
18361	26.19	40.08	7.94	—	I5B.	18445	26.99	47.63	15.87	—	I2B.	—	27.00	44.40	9.52	—	I2BB
21125	26.19	41.28	11.11	—	I5BB	21143	26.99	47.63	15.88	—	I2BA	—	27.00	45.00	8.00	—	I2BB
21126	26.19	42.86	9.53	—	I5BB	21144	26.99	50.11	11.11	—	I5BA	—	27.00	45.00	8.00	—	I13
18049	26.19	44.45	11.11	—	I5BB	21145	26.99	50.40	11.11	—	I5BB	20194	27.00	45.10	8.00	—	I4BA
17148	26.19	46.83	11.11	—	I5BB	18444	26.99	50.40	11.11	—	I5B.	20194	27.00	45.10	8.00	—	I4BA
—	26.19	46.83	11.11	—	I1FB	18983	26.99	50.80	6.35	—	I4BB	21155	27.00	47.00	7.00	—	I5BB
14762	26.30	33.30	3.20	—	I4BA	—	26.99	50.80	6.35	—	I4BA	—	27.00	47.00	10.00	—	I2BB
16850	26.30	45.30	7.90	—	I5BA	17037	26.99	50.80	6.35	—	I5B.	21156	27.00	47.00	10.00	—	I5BB
20389	26.50	37.50	7.00	—	I2BA	18446	26.99	52.39	11.11	—	I5BB	11391	27.00	49.00	6.35	—	I5BA
—	26.60	30.00	2.00	—	I4BA	21146	26.99	52.39	11.11	—	I5B.	—	27.00	50.00	10.00	—	I5BB
—	26.80	29.96	1.90	—	I4BA	21147	26.99	55.56	11.11	—	I5BB	14251	27.00	50.00	10.00	—	I5BA
13210	26.80	30.00	2.00	—	I4BA	15843	26.99	55.56	11.11	—	I5C	11284	27.00	50.50	11.00	—	I5B
13984	26.80	35.00	2.40	—	I2B.	15919	26.99	58.74	11.11	—	ESPE	16799	27.00	50.80	9.50	—	I5B.
—	26.80	38.07	5.56	—	I2BB	21148	26.99	63.50	11.11	—	I5BB	16455	27.00	51.00	5.50	—	I5BB
12697	26.90	38.10	5.50	—	I5BB	18219	26.99	63.50	11.11	—	I5B.	16449	27.00	51.00	11.00	—	I5BA
15589	26.98	46.83	11.11	—	I5C	16082	27.00	33.00	3.00	—	I4BB	21157	27.00	52.00	10.00	—	I5BB
11180	26.99	33.34	3.17	—	I4BA	11135	27.00	33.40	4.00	—	I4BB	13781	27.00	54.00	12.00	—	I5BA
17977	26.99	33.34	4.76	—	I4BB	16076	27.00	33.50	4.00	—	I4BB	15843	27.00	55.56	11.11	—	I5BB
—	26.99	33.34	4.76	—	I4BA	—	27.00	33.95	3.00	—	I4BA	11160	27.00	56.00	7.00	—	I2BB
11179	26.99	33.73	3.97	—	I4BA	—	27.00	34.00	4.00	—	I4BB	—	27.00	62.00	11.00	—	I5BB
12708	26.99	34.93	3.97	—	I4BB	12813	27.00	34.00	4.80	—	I4BB	21158	27.00	62.00	11.00	—	I5BB
—	26.99	36.69	7.94	—	I5C	—	27.00	34.92	5.15	—	I4BA	20045	27.40	35.00	7.00	—	I5BB
21127	26.99	38.10	6.35	—	I5BB	F1226	27.00	35.00	4.00	—	AUP	16401	27.40	47.15	11.30	—	I2B.
21128	26.99	38.10	6.35	—	I5BA	21149	27.00	36.00	7.00	—	I5BB	20407	27.50	39.50	10.00	—	I5BB
21129	26.99	38.10	6.35	—	I2BA	14246	27.00	36.00	7.00	—	I5BA	—	27.50	39.60	6.35	—	I4BA
13836	26.99	38.10	7.94	—	I2BB	14246	27.00	36.00	7.00	—	I5B.	17917	27.78	34.93	4.76	—	I4BA
13836	26.99	38.10	7.94	—	I5BB	—	27.00	36.00	8.00	—	I2BB	15299	27.78	37.31	7.94	—	F
21130	26.99	38.10	8.33	—	I5B.	12723	27.00	36.00	10.00	—	I5BB	17165	27.78	44.45	6.35	—	CORT
18443	26.99	38.10	9.92	—	I5B.	—	27.00	37.00	7.00	—	I2BB	—	27.78	44.45	6.35	—	I4BA
17749	26.99	38.18	6.40	—	I5BB	14247	27.00	37.00	7.00	—	I5BB	17244	27.78	46.43	15.87	—	I2B.
17749	26.99	38.18	6.40	—	I5BA	14247	27.00	37.00	7.00	—	I5B.	15037	27.78	46.83	11.11	—	I5B.
21131	26.99	38.50	9.76	—	I5BB	—	27.00	38.00	7.00	—	I2BB	15037	27.78	46.83	11.11	—	I5BB
—	26.99	39.69	3.18	—	I4BA	21150	27.00	38.00	10.00	—	I2BB	15037	27.78	46.83	11.11	—	I5C
16898	26.99	39.69	6.35	—	I5BB	—	27.00	38.07	7.93	—	I5BA	21159	27.78	47.63	9.53	—	I5BB
21132	26.99	39.69	9.53	—	I5BB	17749	27.00	38.10	6.40	—	I5BA	18344	27.78	50.40	12.70	—	I5B.
15563	26.99	41.28	6.35	—	I4BB	—	27.00	39.00	5.00	—	I5BB	—	27.95	56.00	10.00	—	I2BB
20195	26.99	41.28	6.35	—	I5BB	21151	27.00	39.00	5.00	—	I5BB	12850	28.00	33.00	6.00	—	I4BA
21133	26.99	41.28	7.94	—	I5BA	—	27.00	39.00	10.50	—	I2BB	—	28.00	34.00	10.00	—	I4BA
18345	26.99	41.28	11.11	—	I5B.	11867	27.00	39.50	9.50	—	I5B.	12148	28.00	35.00	4.00	—	I4BA
21135	26.99	41.28	12.70	—	I5BB	—	27.00	40.00	6.00	—	I2BB	—	28.00	35.00	5.00	—	I4BA
13301	26.99	42.86	6.35	—	I5BA	13569	27.00	40.00	6.50	—	I5BA	—	28.00	35.00	6.00	—	I4BA
13301	26.99	42.86	6.35	—	I5BB	—	27.00	40.00	7.00	—	I2BB	—	28.00	36.00	6.00	—	I2BB



# Retentores

Perfis - Ver Última Página



INCOVE VEDAÇÕES LTDA.

Cod.	Di	De	Ha1	Ha2	Mod	Cod.	Di	De	Ha1	Ha2	Mod	Cod.	Di	De	Ha1	Ha2	Mod
16223	28.00	36.70	7.00	—	14BA	11796	28.00	42.50	8.00	—	12BB	16504	28.00	52.00	7.00	—	15BA
12149	28.00	37.00	4.00	—	14BB	21167	28.00	42.86	9.53	—	15BA	21182	28.00	52.00	8.00	—	15BB
12149	28.00	37.00	4.00	—	14BA	12056	28.00	43.00	8.00	—	12BB	—	28.00	52.00	9.00	—	12BB
—	28.00	37.00	4.00	—	14B	18055	28.00	43.00	9.00	—	15B.	14258	28.00	52.00	9.00	—	113
16536	28.00	37.00	6.00	—	15BB	—	28.00	43.00	10.00	—	15BA	21181	28.00	52.00	9.00	—	15B.
16536	28.00	37.00	6.00	—	15BA	15856	28.00	43.00	10.00	12.00	15BB	—	28.00	52.00	10.00	—	12BA
17918	28.00	37.00	14.29	—	15BA	21168	28.00	43.00	10.00	—	12BA	—	28.00	52.00	10.00	—	12BB
—	28.00	38.00	5.00	—	12BB	RU10	28.00	44.00	7.00	—	15BB	14259	28.00	52.00	10.00	—	15BB
11615	28.00	38.00	6.00	—	12BB	16465	28.00	44.00	8.00	—	15BB	—	28.00	52.00	10.00	—	113
12230	28.00	38.00	6.50	—	14BB	16623	28.00	44.00	8.00	—	12BB	14259	28.00	52.00	10.00	—	15B.
—	28.00	38.00	7.00	—	12BB	—	28.00	45.00	7.50	—	12BB	16734	28.00	52.00	10.00	—	12BB
—	28.00	38.00	7.00	—	12BA	21169	28.00	45.00	7.50	—	15BA	21183	28.00	52.00	12.00	—	15B.
—	28.00	38.00	7.00	—	12BB	13039	28.00	45.00	8.00	—	113	16272	28.00	52.00	13.00	—	15BB
14252	28.00	38.00	7.00	—	15BB	14097	28.00	45.00	8.00	—	15BB	21184	28.00	55.00	7.00	—	15BB
14252	28.00	38.00	7.00	—	15BA	16640	28.00	45.00	8.00	—	13B.	20225	28.00	55.00	8.00	—	15BB
11671	28.00	38.00	9.00	—	15BB	16640	28.00	45.00	8.00	—	13B.	25446	28.00	55.00	10.00	—	15BB
20308	28.00	38.20	5.00	—	14BB	21170	28.00	45.00	8.50	—	15BB	12999	28.00	55.00	11.00	—	15BB
11755	28.00	39.00	8.00	—	12BB	13999	28.00	45.00	9.50	—	15BB	—	28.00	55.60	10.00	—	15BB
22445	28.00	40.00	5.00	—	14BA	14255	28.00	45.00	10.00	—	15BB	—	28.00	56.00	7.00	—	12BB
—	28.00	40.00	5.00	—	14BA	14255	28.00	45.00	10.00	—	15BA	—	28.00	62.00	9.00	—	12BB
11188	28.00	40.00	6.00	—	12BB	14255	28.00	45.00	10.00	—	15BB	22469	28.00	62.00	10.00	—	15BB
14688	28.00	40.00	7.00	—	15BB	25465	28.00	46.00	14.00	—	TDUO	21185	28.00	62.00	12.00	—	15B.
14688	28.00	40.00	7.00	—	15BB	—	28.00	47.00	5.00	—	14BB	11600	28.00	65.00	12.00	—	15BB
14688	28.00	40.00	7.00	—	15BB	21171	28.00	47.00	5.00	—	15BB	21186	28.00	65.00	13.00	—	15BB
14688	28.00	40.00	7.00	—	15BB	14849	28.00	47.00	5.00	—	14BB	14260	28.00	70.00	5.00	—	15BA
14688	28.00	40.00	7.00	—	15BB	14849	28.00	47.00	5.00	—	14BB	14261	28.00	72.00	9.00	—	15BA
21160	28.00	40.00	7.00	—	15BA	—	28.00	47.00	7.00	—	15BB	14261	28.00	72.00	9.00	—	15BB
11104	28.00	40.00	7.00	—	12BB	25393	28.00	47.00	7.00	—	12BB	21188	28.00	72.00	10.00	—	15B.
—	28.00	40.00	7.00	—	17B.	12046	28.00	47.00	7.00	—	15BB	20251	28.00	72.00	10.00	—	15BB
—	28.00	40.00	7.00	—	15BB	12046	28.00	47.00	7.00	—	15BA	—	28.13	42.50	9.00	—	12BB
11104	28.00	40.00	7.00	—	12BB	12046	28.00	47.00	7.00	—	15BB	—	28.18	38.10	6.50	—	14BB
13774	28.00	40.00	8.00	—	15BB	12046	28.00	47.00	7.00	—	15BB	21189	28.18	55.56	10.00	—	15BB
—	28.00	40.00	8.00	—	17BB	—	28.00	47.00	8.00	—	15BA	—	28.20	37.95	6.00	—	15BB
—	28.00	40.00	8.00	—	12BB	—	28.00	47.00	8.00	—	15BA	21190	28.30	43.00	7.00	—	15BB
—	28.00	40.00	8.00	—	12BB	21172	28.00	47.00	9.00	—	15B.	14097	28.40	45.00	8.50	—	15BB
—	28.00	40.00	8.00	—	17B.	14256	28.00	47.00	10.00	—	15BA	14097	28.40	45.00	8.50	—	15BB
13774	28.00	40.00	8.00	—	15BB	14256	28.00	47.00	10.00	—	15BB	—	28.50	34.92	3.10	—	14BA
13774	28.00	40.00	8.00	—	15BB	14256	28.00	47.00	10.00	—	15BA	13925	28.50	35.30	5.30	—	14BB
—	28.00	40.00	8.20	—	12BB	14256	28.00	47.00	10.00	—	15B.	11615	28.50	38.00	6.00	—	12BB
25444	28.00	40.00	9.00	—	15BA	14890	28.00	47.00	10.00	—	113	—	28.50	38.00	6.00	—	15BB
22581	28.00	40.00	10.00	—	15BB	14256	28.00	47.00	10.00	—	15BB	—	28.50	39.40	7.54	—	12BB
21161	28.00	40.00	10.00	—	15BA	21173	28.00	47.00	10.00	—	15B.	—	28.50	39.65	6.35	—	14BA
14253	28.00	40.00	10.00	—	15B.	11750	28.00	47.00	10.00	—	12BB	22422	28.50	40.00	5.00	—	14BA
14253	28.00	40.00	10.00	—	15B.	21175	28.00	47.00	10.00	—	12BA	16508	28.50	41.30	6.40	—	12BA
—	28.00	40.00	10.50	—	12BB	14256	28.00	47.00	10.00	—	15BA	—	28.50	41.30	7.93	—	15BA
11282	28.00	40.00	10.50	—	ESPE	14256	28.00	47.00	10.00	—	15B.	—	28.50	43.00	9.00	—	12BB
11282	28.00	40.00	10.50	—	12BA	12610	28.00	47.00	10.00	—	17BA	USINA	28.50	47.50	—	9.00	15TG
25382	28.00	40.20	15.00	—	17BB	14256	28.00	47.00	10.00	—	15BB	16961	28.50	47.60	6.30	—	12BA
12599	28.00	40.50	8.00	—	15B.	13157	28.00	48.00	4.00	—	180	22507	28.50	50.90	10.00	—	15BA
—	28.00	41.00	7.00	—	12BB	21176	28.00	48.00	8.00	—	15BB	—	28.50	52.00	5.00	—	14BB
11466	28.00	41.00	8.00	—	15BB	21177	28.00	48.00	8.00	—	15BA	13640	28.50	52.00	5.00	—	15BB
14250	28.00	42.00	5.00	—	14BA	24671	28.00	48.00	9.00	—	15BB	16012	28.50	52.00	10.00	—	15BB
—	28.00	42.00	7.00	—	12BB	11480	28.00	48.00	10.00	—	15BB	20381	28.50	52.00	12.00	—	12B.
16299	28.00	42.00	7.00	—	12BB	12499	28.00	48.00	11.00	—	15BA	—	28.57	38.12	6.35	—	15BB
14254	28.00	42.00	7.00	—	15B.	21178	28.00	48.00	11.00	—	12BA	11175	28.58	33.73	3.97	—	14BA
14254	28.00	42.00	7.00	—	15BB	—	28.00	50.00	10.00	—	12BB	—	28.58	34.93	3.18	—	14BA
14254	28.00	42.00	7.00	—	15B.	21179	28.00	50.00	10.00	—	15BB	15897	28.58	34.93	4.76	—	14BA
16299	28.00	42.00	7.00	—	12BA	14257	28.00	50.00	10.00	—	15BA	15897	28.58	34.93	4.76	—	14BB
21164	28.00	42.00	8.00	—	15BB	14257	28.00	50.00	10.00	—	15BA	15754	28.58	36.51	6.35	—	14BA
21163	28.00	42.00	8.00	—	15BA	21180	28.00	50.00	10.00	—	15B.	15754	28.58	36.51	6.35	—	14BB
11804	28.00	42.00	8.00	—	12BB	14269	28.00	50.00	12.00	—	15B.	15754	28.58	36.51	6.35	—	14C
11804	28.00	42.00	8.00	—	12BB	14269	28.00	50.00	12.00	—	15B.	—	28.58	36.51	7.14	—	14BA
—	28.00	42.00	10.00	—	12BB	16568	28.00	51.00	6.00	—	12BA	17918	28.58	36.51	14.29	—	15BA
21165	28.00	42.00	10.00	—	12BB	11373	28.00	51.00	10.00	—	15BB	15700	28.58	38.10	3.97	—	15BB
—	28.00	42.50	8.00	—	15BB	12658	28.00	52.00	6.00	—	12BB	13851	28.58	38.10	4.76	—	14BA
13747	28.00	42.50	8.00	—	15BB	12658	28.00	52.00	6.00	—	12BB	11446	28.58	38.10	5.56	—	15JM
21166	28.00	42.50	8.00	—	15BA	—	28.00	52.00	7.00	—	12BB	17741	28.58	38.10	6.35	—	15BB



# Retentores

Perfis - Ver Última Página



INCOVE VEDAÇÕES LTDA.

Cod.	Di	De	Ha1	Ha2	Mod	Cod.	Di	De	Ha1	Ha2	Mod	Cod.	Di	De	Ha1	Ha2	Mod
17741	28.58	38.10	6.35	—	15BA	17676	28.58	44.45	11.11	—	15B.	20066	28.58	50.80	6.35	—	15BA
17741	28.58	38.10	6.35	—	15BA	18299	28.58	44.45	11.11	—	12BB	12918	28.58	50.80	6.35	—	12BB
21192	28.58	38.10	7.14	—	15BB	21205	28.58	44.45	11.11	—	12BA	12918	28.58	50.80	6.35	—	12BA
21193	28.58	38.10	7.94	—	15B.	17676	28.58	44.45	11.11	—	15C	12918	28.58	50.80	6.35	—	12BB
15600	28.58	38.10	9.52	—	F	19990	28.58	44.45	14.28	—	17B.	13430	28.58	50.80	9.52	—	15BA
15030	28.58	39.69	4.76	—	14BB	15971	28.58	44.45	15.87	—	REPA	13430	28.58	50.80	9.52	—	15BA
15030	28.58	39.69	4.76	—	14BB	21207	28.58	44.45	15.88	—	15BA	13430	28.58	50.80	9.52	—	15JM
—	28.58	39.69	4.76	—	14BB	13871	28.58	45.24	11.11	—	15BA	13430	28.58	50.80	9.52	—	15B.
15030	28.58	39.69	4.76	—	14B.	17675	28.58	46.04	12.70	—	ESP	18009	28.58	50.80	11.11	—	15B.
15030	28.58	39.69	4.76	—	14C	18986	28.58	46.43	6.35	—	14B.	18009	28.58	50.80	11.11	—	15C
17236	28.58	39.69	6.35	—	15BB	12352	28.58	46.43	7.94	—	15BA	—	28.58	50.80	11.11	—	15C
17236	28.58	39.69	6.35	—	15BB	15282	28.58	46.43	7.94	—	12BA	—	28.58	50.80	11.11	—	11FC
17236	28.58	39.69	6.35	—	15B.	12054	28.58	46.43	11.11	—	15B.	18232	28.58	50.80	11.11	—	11FB
17236	28.58	39.69	7.00	—	15BB	21209	28.58	46.43	11.11	—	15BB	13425	28.58	50.80	12.70	—	15BB
—	28.58	39.69	7.94	—	14BB	12054	28.58	46.43	11.11	—	15BA	21220	28.58	50.80	12.70	—	15BA
13380	28.58	39.69	7.94	—	15BB	21208	28.58	46.43	11.11	—	15B.	21221	28.58	50.80	12.70	—	15B.
13380	28.58	39.69	7.94	—	15BB	21210	28.58	46.43	11.11	—	12B.	17153	28.58	50.80	15.87	—	12C
15032	28.58	39.69	9.52	—	15BB	—	28.58	46.43	11.11	—	11FB	13441	28.58	50.80	15.87	—	11FC
15032	28.58	39.69	9.52	—	15BA	—	28.58	46.43	15.08	—	11FC	17730	28.58	50.80	15.87	—	112B
15032	28.58	39.69	9.52	—	15B.	—	28.58	46.83	5.16	—	14BB	—	28.58	50.80	15.88	—	12C
—	28.58	39.69	9.52	—	15BB	15983	28.58	46.83	7.94	—	15BA	13621	28.58	51.59	4.76	—	14BB
15032	28.58	39.69	9.52	—	15BB	13349	28.58	46.83	7.94	—	12BA	—	28.58	52.39	4.76	—	14BA
15032	28.58	39.69	9.52	—	15B.	15983	28.58	46.83	7.94	—	15BA	15574	28.58	52.39	6.35	—	14
15032	28.58	39.69	9.52	—	15BB	13331	28.58	46.83	9.52	—	15B.	—	28.58	52.39	6.35	—	14BA
15032	28.58	39.69	9.52	—	15C	15575	28.58	46.83	11.11	—	15BB	13350	28.58	52.39	9.52	—	15B.
18447	28.58	39.69	17.46	—	17B.	15575	28.58	46.83	11.11	—	15BB	21222	28.58	52.39	9.53	—	15B.
—	28.58	39.69	17.86	—	17B.	15575	28.58	46.83	11.11	—	15B.	17013	28.58	52.39	11.11	—	15BA
—	28.58	40.08	5.00	—	14BA	15575	28.58	46.83	11.11	—	15C	21223	28.58	52.39	11.11	—	12B.
—	28.58	41.20	6.20	—	12BA	17244	28.58	46.83	15.87	—	12B.	17013	28.58	52.39	11.11	—	15C
15563	28.58	41.28	6.35	—	14BB	13384	28.58	46.83	15.87	—	11FC	12963	28.58	53.98	6.35	—	15BA
21194	28.58	41.28	6.35	—	15BB	18449	28.58	47.23	7.94	—	15BB	12565	28.58	53.98	9.52	—	12BA
12463	28.58	41.28	6.35	—	12BA	18450	28.58	47.63	6.35	—	14BA	21224	28.58	53.98	9.53	—	15BB
21196	28.58	41.28	6.35	—	12BA	21211	28.58	47.63	6.35	—	15BB	11093	28.58	53.98	11.11	—	15BB
13866	28.58	41.28	7.94	—	15BB	—	28.58	47.63	7.94	—	17B.	11093	28.58	53.98	11.11	—	15B.
13866	28.58	41.28	7.94	—	15B.	21212	28.58	47.63	7.94	—	12BA	21225	28.58	53.98	11.11	—	12B.
18217	28.58	41.28	9.52	—	15BA	21214	28.58	47.63	9.52	—	15BB	21226	28.58	53.98	12.70	—	15BB
15922	28.58	41.28	9.52	—	F	13262	28.58	47.63	9.52	—	12BB	14046	28.58	53.98	19.05	—	11FB
18217	28.58	41.28	9.52	—	15BA	13262	28.58	47.63	9.52	—	15BB	12955	28.58	55.56	3.97	—	15BA
18217	28.58	41.28	9.52	—	15B.	13262	28.58	47.63	9.52	—	15BB	21227	28.58	55.56	11.91	—	15BB
11407	28.58	41.28	9.52	—	12BA	13122	28.58	47.63	9.52	—	12B.	18454	28.58	57.15	6.35	—	14BB
11407	28.58	41.28	9.52	—	12B.	13122	28.58	47.63	9.52	—	12B.	—	28.58	57.15	6.35	—	14BA
21197	28.58	41.28	9.53	—	15BB	15085	28.58	47.63	11.11	—	15B.	14726	28.58	57.15	9.52	—	15BB
—	28.58	41.28	9.53	—	112B	16283	28.58	47.63	11.11	—	12B.	14726	28.58	57.15	9.52	—	15BB
18345	28.58	41.28	11.11	—	15B.	15085	28.58	47.63	11.11	—	15C	14726	28.58	57.15	9.52	—	15BB
12183	28.58	41.28	14.28	—	19B.	13257	28.58	47.63	15.87	—	12BC	21228	28.58	57.15	12.70	—	15BA
—	28.58	41.28	14.29	—	17BA	15066	28.58	47.63	15.87	—	11BF	18455	28.58	57.15	12.70	—	15B.
21198	28.58	41.28	15.08	—	15B.	13257	28.58	47.63	15.87	—	12C	17540	28.58	57.55	11.91	—	113
18448	28.58	41.28	15.08	—	12BA	15066	28.58	47.63	15.87	—	11FC	15274	28.58	58.74	9.52	—	F
12800	28.58	41.28	15.87	—	14BA	13052	28.58	47.63	15.87	—	112C	15413	28.58	60.33	11.91	—	113
13478	28.58	42.86	6.35	—	12BA	—	28.58	47.63	21.43	—	19B	18456	28.58	60.33	12.70	—	15B.
14736	28.58	42.86	6.35	—	14BB	21215	28.58	49.21	7.94	—	15BA	21229	28.58	60.33	12.70	—	15BB
21199	28.58	42.86	6.35	—	15BB	—	28.58	49.21	9.53	—	14BB	21230	28.58	61.91	11.11	—	15BB
14747	28.58	42.86	6.35	—	13BA	21216	28.58	49.21	11.11	—	15BB	21231	28.58	61.91	11.91	—	15B.
13478	28.58	42.86	6.35	—	12BA	18452	28.58	49.21	11.11	—	15B.	18457	28.58	61.91	12.70	—	15B.
13559	28.58	42.86	7.14	—	15BA	18892	28.58	49.21	15.08	—	113	15284	28.58	64.29	13.49	—	ESP
13434	28.58	42.86	7.94	—	15BB	17801	28.58	49.21	15.87	—	ESP	21233	28.58	64.29	14.29	—	15BB
21200	28.58	42.86	9.13	—	15BB	21217	28.58	49.21	15.88	—	15BB	15637	28.58	64.29	14.29	—	15B.
21201	28.58	42.86	9.13	—	15BA	21218	28.58	50.08	9.92	—	15BA	17541	28.58	64.69	12.70	—	113
18055	28.58	42.86	9.52	—	15B.	21219	28.58	50.40	9.33	—	15B.	21234	28.58	70.64	13.49	—	15BB
21202	28.58	43.66	10.32	—	15BB	13543	28.58	50.40	9.52	—	15B.	18458	28.58	70.64	13.49	—	15B.
—	28.58	44.45	6.35	—	14BA	13543	28.58	50.40	9.52	—	15BA	18459	28.58	73.03	11.91	—	15BB
21203	28.58	44.45	6.35	—	15BA	13543	28.58	50.40	9.52	—	15BA	15275	28.58	92.08	15.48	—	155
13415	28.58	44.45	7.94	—	15BB	18344	28.58	50.40	11.11	—	15B.	15275	28.58	115.50	15.48	—	155B
21204	28.58	44.45	7.94	—	12B.	17069	28.58	50.40	15.87	—	11FC	17451	28.59	47.63	21.43	—	19B.
13660	28.58	44.45	9.52	—	15BA	17069	28.58	50.40	15.88	—	11FC	—	28.60	36.40	5.15	—	14BA
18299	28.58	44.45	11.11	—	12BA	13642	28.58	50.80	3.17	—	14BA	—	28.60	36.40	7.14	—	14BA
21206	28.58	44.45	11.11	—	15BB	18453	28.58	50.80	6.35	—	14BA	—	28.60	38.10	6.00	—	15BB



# Retenfores

Perfis - Ver Última Página



INCOVE VEDAÇÕES LTDA.

Cod.	Di	De	Ha1	Ha2	Mod	Cod.	Di	De	Ha1	Ha2	Mod	Cod.	Di	De	Ha1	Ha2	Mod
22527	28.60	38.10	6.00	—	I5BB	15966	29.37	50.80	11.11	—	I5BB	—	30.00	42.00	6.00	—	I2BA
—	28.60	39.65	9.52	—	I5BB	21250	29.37	50.80	11.11	—	I5BA	22500	30.00	42.00	6.00	—	I5JM
—	28.60	39.70	4.76	—	I4BB	21251	29.37	52.39	11.11	—	I5BB	21258	30.00	42.00	6.00	—	I5BA
11824	28.60	40.30	5.00	—	I4BA	21252	29.37	53.18	11.51	—	I5BB	21259	30.00	42.00	6.00	—	I2BB
—	28.60	41.20	7.00	—	I2BA	—	29.37	53.49	11.90	—	I5BB	—	30.00	42.00	7.00	—	I5BB
—	28.60	41.25	6.50	—	I2BA	17696	29.37	53.58	19.05	—	I1FB	—	30.00	42.00	7.00	—	I2BB
—	28.60	41.25	6.50	—	I5BA	17326	29.37	53.98	11.11	—	I5B.	13233	30.00	42.00	7.00	—	I2BA
—	28.60	41.25	10.50	—	I2BA	17529	29.37	53.98	16.67	—	I1FB	16756	30.00	42.00	7.00	—	I4BA
—	28.60	41.27	9.50	—	I2BA	16538	29.37	54.00	11.50	—	I5B.	12186	30.00	42.00	7.00	—	I5BB
—	28.60	42.95	6.50	—	I2BA	21253	29.37	55.56	6.35	—	I5BA	12186	30.00	42.00	7.00	—	I5BA
—	28.60	44.40	11.11	—	I5BB	15689	29.37	55.56	6.35	—	I5BA	—	30.00	42.00	7.00	—	I2BB
16383	28.60	44.50	11.00	—	I2BB	17540	29.37	57.55	10.32	—	I13	12186	30.00	42.00	7.00	—	I5B.
22472	28.60	47.60	6.30	—	I5BB	15413	29.37	60.33	11.91	—	I13	13233	30.00	42.00	7.00	—	I2BB
11529	28.60	48.00	6.00	—	I5BB	15284	29.37	65.88	13.49	—	ESP	13233	30.00	42.00	7.00	—	I2BA
16964	28.60	50.80	9.50	—	I5JM	—	29.50	37.00	7.50	—	ESPE	12002	30.00	42.00	7.00	—	I5BB
—	28.60	50.80	11.11	—	I5BA	21255	29.50	43.00	8.00	—	I5BB	13233	30.00	42.00	7.00	—	I2BB
16736	28.60	51.80	9.20	—	I5BA	21256	29.50	47.50	8.00	—	I5B.	—	30.00	42.00	8.00	—	I2BB
—	28.60	52.37	11.11	—	I5BA	16678	29.50	54.00	15.00	—	I5B.	—	30.00	42.00	8.00	—	I2BA
—	28.60	55.50	10.31	—	I5BB	—	29.59	56.57	12.70	—	I5BA	14265	30.00	42.00	8.00	—	I5BB
—	28.70	31.80	3.00	—	I5BA	—	29.77	51.59	9.52	—	I5BA	12340	30.00	42.00	8.00	9.00	ESPE
14264	28.70	40.00	7.00	—	I5BA	11866	29.80	62.00	9.80	—	I2BA	14265	30.00	42.00	8.00	—	I5BB
21236	28.97	46.43	11.51	—	I5BB	—	29.84	45.02	7.00	—	I5BB	14265	30.00	42.00	8.00	—	I5BA
12150	29.00	38.00	4.00	—	I4BA	—	29.84	46.46	9.52	—	I5BB	14265	30.00	42.00	8.00	—	I5BB
20126	29.00	39.50	8.00	—	I2BB	25394	29.90	58.10	8.00	—	I5BA	13232	30.00	42.00	8.00	—	I2BB
13478	29.00	40.00	5.00	—	I4BA	—	30.00	36.95	3.00	—	I4BA	13232	30.00	42.00	8.00	—	I2BA
—	29.00	40.00	7.00	—	I2BB	12151	30.00	37.00	4.00	—	I4BB	14265	30.00	42.00	8.00	—	I5BB
21237	29.00	40.00	7.00	—	I5BA	12650	30.00	37.00	4.00	—	I5BA	13232	30.00	42.00	8.00	—	I2BB
13139	29.00	40.00	9.00	—	I5BB	12151	30.00	37.00	4.00	—	I4BB	16560	30.00	42.00	9.00	—	I4B.
21238	29.00	40.00	9.00	—	I5BA	12151	30.00	37.00	4.00	—	I4BA	—	30.00	42.00	10.00	—	I2BB
—	29.00	41.00	5.00	—	I4BB	12151	30.00	37.00	4.00	—	I4BA	13542	30.00	42.00	10.00	—	I2BB
21239	29.00	43.00	7.00	—	I5BB	12650	30.00	37.00	4.00	—	I5BA	13766	30.00	42.00	10.00	—	I5BA
11654	29.00	43.00	8.00	—	I2BB	—	30.00	38.00	5.00	—	I4BB	13542	30.00	42.00	10.00	—	I2BB
13523	29.00	44.00	8.50	—	I4BA	—	30.00	38.00	7.00	—	I2BB	11827	30.00	42.30	7.00	—	I2BB
13523	29.00	44.00	8.50	—	I4BA	16492	30.00	38.00	7.00	—	I5BB	11827	30.00	42.35	7.00	—	I2BB
11435	29.00	45.00	8.50	—	I5BA	14263	30.00	39.00	8.00	—	I5BB	14266	30.00	43.00	7.00	—	I5BA
—	29.00	45.00	10.00	—	I5BA	16254	30.00	39.00	14.00	—	I4BA	—	30.00	43.00	8.00	—	I5BA
21240	29.00	45.00	10.00	—	I5BB	12152	30.00	40.00	4.00	—	I4BA	12086	30.00	43.00	8.50	—	I2BB
16785	29.00	45.00	10.00	—	I2BB	13743	30.00	40.00	4.00	—	I5BB	—	30.00	44.00	7.00	—	I2BB
14690	29.00	45.50	10.00	—	I5BB	13743	30.00	40.00	4.00	—	I5BB	14267	30.00	44.00	8.00	—	I2BB
14690	29.00	45.50	10.00	—	I5B.	14853	30.00	40.00	5.00	—	I4BA	13678	30.00	44.00	9.00	—	I5BB
21241	29.00	46.00	10.00	—	I5BB	11252	30.00	40.00	5.00	—	I4BA	—	30.00	44.00	10.00	—	I2BB
14262	29.00	46.00	10.00	—	I5B.	20324	30.00	40.00	5.00	—	I5BB	21260	30.00	44.00	10.00	—	I5BA
14262	29.00	46.00	10.00	—	I5C	14366	30.00	40.00	6.00	—	I4BB	11941	30.00	44.00	10.00	—	I5B.
—	29.00	46.00	10.00	—	I1FB	14366	30.00	40.00	6.00	—	I4BA	11389	30.00	44.00	12.00	—	I5BA
—	29.00	46.46	11.50	—	I5BB	14366	30.00	40.00	6.00	—	I4BB	21261	30.00	44.50	10.00	—	I5B.
—	29.00	46.46	11.50	—	I2BB	14264	30.00	40.00	7.00	—	I5BB	16911	30.00	45.00	5.00	—	I5BB
—	29.00	47.00	6.00	—	I2BB	—	30.00	40.00	7.00	—	I2BB	—	30.00	45.00	7.00	—	I2BB
21242	29.00	47.00	10.00	—	I5B.	14264	30.00	40.00	7.00	—	I5BB	13811	30.00	45.00	7.00	—	I5BA
—	29.00	47.80	6.30	—	I5BB	14264	30.00	40.00	7.00	—	I5BB	21262	30.00	45.00	7.00	—	I5BB
—	29.00	50.00	10.00	—	I5B.	13743	30.00	40.00	7.00	—	I5BB	13811	30.00	45.00	7.00	—	I5BA
11894	29.00	50.00	10.00	—	I5B.	—	30.00	40.00	7.00	—	I2BB	—	30.00	45.00	8.00	—	I5BB
11894	29.00	50.00	10.00	—	I5BB	12047	30.00	40.00	7.00	—	I2BB	—	30.00	45.00	8.00	—	I5BB
21243	29.00	52.00	10.00	—	I5B.	13497	30.00	40.00	8.00	—	I5BA	14268	30.00	45.00	8.00	—	I5BB
—	29.37	39.29	6.35	—	I4BB	12867	30.00	40.00	8.00	—	I4BA	14268	30.00	45.00	8.00	—	I5BA
—	29.37	42.82	11.11	—	I5BA	21257	30.00	40.00	8.00	—	I5BB	14268	30.00	45.00	8.00	—	I5BA
21244	29.37	42.86	7.94	—	I2BB	12047	30.00	40.00	8.00	—	I2BB	20070	30.00	45.00	8.00	—	I2BB
16313	29.37	42.86	9.52	—	I2BB	—	30.00	40.00	10.00	—	I2BB	14268	30.00	45.00	8.00	—	I5BB
21245	29.37	46.43	9.53	—	I5BA	13493	30.00	40.00	10.00	—	I5BA	—	30.00	45.00	10.00	—	I5BB
21247	29.37	46.43	9.53	—	I5BB	.....	30.00	40.50	10.50	—	I2BB	—	30.00	45.00	10.00	—	I2BB
21246	29.37	46.43	9.53	—	I5B.	12985	30.00	40.50	10.50	—	I2BA	14098	30.00	45.00	10.00	—	I5BB
15264	29.37	46.43	10.00	—	I5B.	—	30.00	41.00	10.00	—	I2BA	14308	30.00	45.00	12.00	—	I5BB
15264	29.37	46.43	11.11	—	I5BB	25351	30.00	41.30	8.00	—	I5BB	14308	30.00	45.00	12.00	—	I5BB
15264	29.37	46.43	11.11	—	I5BB	11741	30.00	42.00	5.50	—	I5BB	20240	30.00	45.00	13.00	—	I2BB
11077	29.37	46.43	11.11	—	I2BB	16894	30.00	42.00	5.50	—	I2BB	21342	30.00	45.50	7.00	—	I5BA
11340	29.37	46.83	9.52	—	I5BB	13979	30.00	42.00	5.70	—	I5BB	—	30.00	46.00	7.00	—	I2BB
13872	29.37	48.42	11.11	—	I5BA	13979	30.00	42.00	5.70	—	I5BB	—	30.00	46.00	8.00	—	I2BB
21249	29.37	50.80	7.94	—	I2BA	—	30.00	42.00	6.00	—	I2BB	—	30.00	46.00	8.00	—	I2BB





# Retentores

Perfis - Ver Última Página



INCOVE VEDAÇÕES LTDA.

Cod.	Di	De	Ha1	Ha2	Mod	Cod.	Di	De	Ha1	Ha2	Mod	Cod.	Di	De	Ha1	Ha2	Mod
21263	30.00	46.00	8.00	—	15BB	21279	30.00	50.00	10.00	—	15BB	20364	30.00	54.00	10.00	—	15BB
13225	30.00	46.50	10.00	—	15BA	14276	30.00	50.00	10.00	—	15B.	16438	30.00	54.40	11.40	—	15BB
—	30.00	47.00	5.00	—	15BB	21278	30.00	50.00	10.00	—	15B.	—	30.00	55.00	7.00	—	12BB
14270	30.00	47.00	6.00	—	15BB	11106	30.00	50.00	10.00	—	12BB	14283	30.00	55.00	7.00	—	113
—	30.00	47.00	6.00	—	15BB	11106	30.00	50.00	10.00	—	12BB	13846	30.00	55.00	7.00	—	14JM
14270	30.00	47.00	6.00	—	15BB	13498	30.00	50.00	11.00	—	12BB	14284	30.00	55.00	7.00	—	15BB
14270	30.00	47.00	6.00	—	15BB	21282	30.00	50.00	11.00	—	15BB	—	30.00	55.00	9.50	—	15BB
—	30.00	47.00	7.00	—	12BB	14276	30.00	50.00	11.00	—	15BA	—	30.00	55.00	10.00	—	12BB
—	30.00	47.00	7.00	—	12BB	13498	30.00	50.00	11.00	—	12BB	14285	30.00	55.00	10.00	—	15BB
16738	30.00	47.00	7.00	—	12BB	—	30.00	50.00	12.00	—	12BB	21293	30.00	55.00	10.00	—	15BA
16738	30.00	47.00	7.00	—	12BB	14277	30.00	50.00	12.00	—	15BA	14285	30.00	55.00	10.00	—	15B.
—	30.00	47.00	7.00	—	12BB	14277	30.00	50.00	12.00	—	15BB	21294	30.00	55.00	10.00	—	12BB
12353	30.00	47.00	7.00	—	15BB	14277	30.00	50.00	12.00	—	15BB	14285	30.00	55.00	10.00	—	15BB
12353	30.00	47.00	7.00	—	15BA	21283	30.00	50.00	12.00	—	15BA	—	30.00	55.00	12.00	—	12BB
—	30.00	47.00	7.00	—	15BB	14277	30.00	50.00	12.00	—	15B.	14286	30.00	55.00	12.00	—	15BA
12353	30.00	47.00	7.00	—	15BB	21284	30.00	50.00	12.00	—	12BA	21296	30.00	55.00	12.00	—	15BB
14271	30.00	47.00	8.00	—	15BA	21285	30.00	51.00	7.00	—	15BB	14286	30.00	55.00	12.00	—	15BA
11542	30.00	47.00	8.00	—	12BA	16013	30.00	51.80	5.00	—	14BB	21295	30.00	55.00	12.00	—	12BA
14271	30.00	47.00	8.00	—	15BB	14279	30.00	52.00	5.00	—	113	—	30.00	56.00	8.00	—	12BB
21265	30.00	47.00	8.00	—	15BA	13535	30.00	52.00	5.00	—	14BA	—	30.00	56.00	10.00	—	12BB
21264	30.00	47.00	8.00	—	15B.	21286	30.00	52.00	6.00	—	15BB	14287	30.00	56.00	10.00	—	15BB
11542	30.00	47.00	8.00	—	12BB	16100	30.00	52.00	6.00	—	12BB	14287	30.00	56.00	10.00	—	15B.
11542	30.00	47.00	8.00	—	12BA	21287	30.00	52.00	6.50	—	15BB	21297	30.00	56.00	10.00	—	12BB
11542	30.00	47.00	8.00	—	12BB	—	30.00	52.00	7.00	—	12BA	14287	30.00	56.00	10.00	—	15BB
11542	30.00	47.00	8.00	—	12BA	—	30.00	52.00	7.00	—	12BB	14287	30.00	56.00	10.00	—	15BB
12354	30.00	47.00	9.00	—	15B.	12225	30.00	52.00	7.00	—	12BA	14287	30.00	56.00	10.00	—	15BB
21266	30.00	47.00	9.00	—	12B.	12355	30.00	52.00	7.00	—	15BA	—	30.00	56.00	12.00	—	15BA
14272	30.00	47.00	10.00	—	15B.	21288	30.00	52.00	7.00	—	12BB	14288	30.00	56.00	12.00	—	15BB
—	30.00	47.00	10.00	—	12BB	12225	30.00	52.00	7.00	—	12BA	14288	30.00	56.00	12.00	—	15BB
14272	30.00	47.00	10.00	—	15BB	—	30.00	52.00	7.00	—	12BA	14288	30.00	56.00	12.00	—	15BA
14272	30.00	47.00	10.00	—	15BA	16100	30.00	52.00	7.00	—	15BB	14288	30.00	56.00	12.00	—	15B.
14272	30.00	47.00	10.00	—	15B.	—	30.00	52.00	8.00	—	12BB	14288	30.00	56.00	12.00	—	15BA
21268	30.00	47.00	10.00	—	15BA	12290	30.00	52.00	8.00	—	12BB	14288	30.00	56.00	12.00	—	15C
21267	30.00	47.00	10.00	—	12BA	—	30.00	52.00	8.00	—	12BB	—	30.00	58.00	8.00	—	12BB
—	30.00	47.00	10.00	—	12BB	14280	30.00	52.00	8.00	—	15BB	—	30.00	60.00	7.00	—	12BB
14272	30.00	47.00	10.00	—	15BA	14280	30.00	52.00	8.00	—	15BB	—	30.00	60.00	8.00	—	12BB
14272	30.00	47.00	10.00	—	15BB	14280	30.00	52.00	8.00	—	15BA	13609	30.00	60.00	8.00	—	15BA
21270	30.00	48.00	6.00	—	15BB	12290	30.00	52.00	8.00	—	12BB	—	30.00	60.00	10.00	—	12BB
—	30.00	48.00	8.00	—	12BB	14281	30.00	52.00	9.00	—	15BA	12686	30.00	60.00	10.00	—	15BB
14273	30.00	48.00	8.00	—	15BB	12356	30.00	52.00	9.00	—	15B.	12686	30.00	60.00	10.00	—	15BA
14273	30.00	48.00	8.00	—	15BA	14281	30.00	52.00	9.00	—	15B.	21298	30.00	61.30	10.00	—	15BA
14273	30.00	48.00	8.00	—	15B.	21289	30.00	52.00	9.00	—	15BA	21299	30.00	62.00	6.00	—	15BA
21271	30.00	48.00	10.00	—	15BB	12356	30.00	52.00	9.00	—	15B.	11603	30.00	62.00	7.00	—	15BA
11006	30.00	48.00	10.00	—	12BB	14281	30.00	52.00	10.00	—	15C	—	30.00	62.00	7.00	—	12BB
21272	30.00	48.00	11.00	—	15BB	21290	30.00	52.00	10.00	—	12BB	25386	30.00	62.00	7.00	—	12BB
11916	30.00	48.00	11.00	—	15B.	14281	30.00	52.00	10.00	—	15BB	21300	30.00	62.00	7.00	—	15BB
11916	30.00	48.00	11.00	—	15BA	14281	30.00	52.00	10.00	—	15BB	11603	30.00	62.00	7.00	—	15BA
21274	30.00	49.00	8.00	—	15BB	14281	30.00	52.00	10.00	—	15B.	21301	30.00	62.00	7.00	—	12BA
14274	30.00	49.00	10.00	—	15B.	21290	30.00	52.00	10.00	—	12BA	11131	30.00	62.00	8.00	—	12BB
14274	30.00	49.00	10.00	—	15C	14281	30.00	52.00	10.00	—	15BA	20297	30.00	62.00	8.00	—	12BB
13007	30.00	49.50	11.00	—	113	14281	30.00	52.00	10.00	—	15BB	20297	30.00	62.00	8.00	—	12BB
14852	30.00	50.00	5.00	—	14BA	21392	30.00	52.00	11.00	—	12BA	13797	30.00	62.00	8.10	—	15BB
14852	30.00	50.00	5.00	—	14BA	14282	30.00	52.00	12.00	—	15C	21302	30.00	62.00	9.00	—	15B.
—	30.00	50.00	7.00	—	15BB	14282	30.00	52.00	12.00	—	15B.	12358	30.00	62.00	10.00	—	12BB
16918	30.00	50.00	7.00	—	15BA	14282	30.00	52.00	12.00	—	15BA	14291	30.00	62.00	10.00	—	15BB
21275	30.00	50.00	7.00	—	15BA	14282	30.00	52.00	12.00	—	15BA	14291	30.00	62.00	10.00	—	15B.
14215	30.00	50.00	7.00	—	15B.	14282	30.00	52.00	12.00	—	15B.	14291	30.00	62.00	10.00	—	15BB
20231	30.00	50.00	7.00	—	12BB	21291	30.00	52.00	12.00	—	12BB	14291	30.00	62.00	10.00	—	15BA
14275	30.00	50.00	7.00	—	15BA	11512	30.00	52.00	12.00	—	12BA	14291	30.00	62.00	10.00	—	15JL
—	30.00	50.00	8.00	—	12BB	14282	30.00	52.00	12.00	—	15BB	14291	30.00	62.00	10.00	—	15BB
—	30.00	50.00	8.00	—	12BB	12357	30.00	52.00	15.00	—	15BB	14291	30.00	62.00	10.00	—	15BA
21276	30.00	50.00	8.00	—	12BB	14576	30.00	52.00	15.00	—	12BB	14291	30.00	62.00	10.00	—	15B.
21277	30.00	50.00	9.00	—	15B.	12545	30.00	52.55	8.00	—	15BA	12358	30.00	62.00	10.00	—	12BB
14276	30.00	50.00	10.00	—	15B	12073	30.00	53.00	6.00	—	15BB	12358	30.00	62.00	10.00	—	12BB
—	30.00	50.00	10.00	—	15BB	13618	30.00	53.00	10.00	—	15B.	14291	30.00	62.00	10.00	—	15BB
21279	30.00	50.00	10.00	—	15BB	21292	30.00	53.00	12.00	—	15B.	11907	30.00	62.00	12.00	—	113
14276	30.00	50.00	10.00	—	15BB	11968	30.00	54.00	5.00	—	15BB	11907	30.00	62.00	12.00	—	113





# Retenfores

Perfis - Ver Última Página



INCOVE VEDAÇÕES LTDA.

Cod.	Di	De	Ha1	Ha2	Mod	Cod.	Di	De	Ha1	Ha2	Mod	Cod.	Di	De	Ha1	Ha2	Mod
21303	30.00	62.00	12.00	—	I5BB	13518	30.16	48.42	6.35	—	I5BB	18467	30.16	61.91	11.91	—	I5BA
14292	30.00	62.00	12.00	—	I5BA	14738	30.16	48.42	6.35	—	I4BB	17457	30.16	61.91	15.87	—	I1FC
14292	30.00	62.00	12.00	—	I5B.	13518	30.16	48.42	6.35	—	I5BB	13205	30.16	61.91	22.22	—	I7B.
17457	30.00	62.00	15.00	—	I1FC	14738	30.16	48.42	6.35	—	I4BB	15107	30.16	65.09	11.91	—	I5BA
20327	30.00	65.00	7.00	—	I5BB	18987	30.16	49.21	6.35	—	I4B.	15279	30.16	68.24	7.94	—	ESPE
—	30.00	65.00	8.00	—	I2BB	21314	30.16	49.21	6.35	—	I5BB	15279	30.16	68.26	7.94	—	ESPE
21304	30.00	65.00	10.00	—	I5BA	21315	30.16	49.21	11.11	—	I5BB	18468	30.16	68.26	12.70	—	I5B.
13733	30.00	65.00	15.00	—	I5BB	18306	30.16	49.21	11.11	—	I5B.	21331	30.16	68.26	12.70	—	I5BB
—	30.00	70.00	10.00	—	I2BB	15339	30.16	50.40	11.11	—	I5B.	18988	30.16	72.23	6.35	—	I4BA
—	30.00	72.00	8.00	—	I2BB	15339	30.16	50.40	11.11	—	I5C	21334	30.16	72.23	6.35	—	I5BB
21305	30.00	72.00	9.50	—	I2BB	21316	30.16	50.40	12.70	—	I5B.	18469	30.16	85.73	11.91	—	I5B.
—	30.00	72.00	10.00	—	I5BA	20009	30.16	50.47	6.35	—	I2BA	21335	30.16	85.73	11.91	—	I5BB
13234	30.00	72.00	10.00	—	I2B.	—	30.16	50.70	6.35	—	I4BA	15286	30.16	130.20	27.78	—	I55
14294	30.00	72.00	10.00	—	I5BB	21317	30.16	50.80	6.35	—	I5BB	16191	30.20	47.70	6.40	—	I5BA
13234	30.00	72.00	10.00	—	I2BB	15882	30.16	50.80	6.35	—	I4B.	20072	30.20	50.80	9.50	—	I4BA
13234	30.00	72.00	10.00	—	I2BB	21317	30.16	50.80	6.35	—	I5BB	21324	30.50	52.40	10.00	—	I5BA
14294	30.00	72.00	10.00	—	I5BB	15882	30.16	50.80	6.35	—	I4BA	17092	30.96	42.07	6.35	—	CORT
14294	30.00	72.00	10.00	—	I5B.	15882	30.16	50.80	6.35	—	I4C	15864	30.96	42.86	9.52	—	I5BA
14294	30.00	72.00	10.00	—	I5B.	21318	30.16	50.80	7.94	—	I5BA	21336	30.96	42.86	9.53	—	I5BB
13156	30.00	72.00	10.50	2.50	ESPE	14719	30.16	50.80	9.52	—	ESPE	21337	30.96	42.86	9.53	—	I5B.
—	30.00	72.00	12.00	—	I2BB	14719	30.16	50.80	9.52	—	I80C	15486	30.96	50.40	11.11	—	I5BB
12739	30.00	72.00	12.00	—	I5B.	15505	30.16	50.80	11.11	—	I5B.	17073	30.96	50.80	11.11	—	I5B.
—	30.00	72.40	20.00	—	ESPE	15505	30.16	50.80	11.11	—	I5BB	15130	30.96	53.98	11.11	—	I5B.
13732	30.00	75.00	15.00	—	I5BB	21320	30.16	50.80	11.11	—	I5BA	15130	30.96	53.98	11.11	—	I5C
11082	30.00	78.00	8.00	11.50	ESPE	21319	30.16	50.80	11.11	—	I5B.	17619	30.96	53.98	19.05	—	I7B.
11605	30.00	80.00	10.00	—	I5BA	21321	30.16	50.80	11.11	—	I2BA	17619	30.96	53.98	19.05	—	I7C
—	30.10	42.82	9.52	—	I5BB	15505	30.16	50.80	11.11	—	I5C	21339	30.96	55.56	12.70	—	I5BB
—	30.10	42.86	6.35	—	I5BA	17143	30.16	50.80	15.87	—	I2BA	15842	30.96	55.56	12.70	—	I5BA
—	30.10	43.55	15.87	—	I2BA	18464	30.16	50.80	20.64	—	I7B.	17932	30.96	69.85	11.91	—	ESPE
—	30.10	47.62	6.35	—	I5BA	—	30.16	51.40	11.90	—	I2BB	19907	30.96	80.96	15.08	—	I80
—	30.10	48.97	11.11	—	I5BB	14851	30.16	51.59	12.70	—	I5BB	16512	31.00	38.00	3.00	—	I4BA
—	30.10	50.80	11.11	—	I2BB	21322	30.16	52.39	5.95	—	I2BB	16703	31.00	39.00	11.00	—	I5BB
—	30.10	50.80	13.10	—	I2BA	13313	30.16	52.39	6.35	—	I4BA	16358	31.00	40.20	7.00	—	I5BB
—	30.10	51.40	11.90	—	I5BA	15351	30.16	52.39	6.35	—	I5BA	15808	31.00	41.00	9.50	—	I5BA
—	30.10	52.28	11.50	—	I5BA	15351	30.16	52.39	6.35	—	I5BA	13754	31.00	43.00	4.50	—	I1BF
—	30.10	61.90	11.90	—	I5BA	21323	30.16	52.39	9.35	—	I5B.	11661	31.00	43.00	7.70	—	I5BA
20094	30.15	44.60	6.35	—	I2BB	17140	30.16	52.39	9.52	—	I13	—	31.00	44.00	6.50	—	I2BB
18119	30.16	39.69	6.35	—	F	21325	30.16	52.39	11.11	—	I5BB	22088	31.00	45.00	7.00	—	I5BB
12239	30.16	39.69	6.35	—	I5BB	15693	30.16	52.39	11.11	—	I5BA	—	31.00	45.00	8.00	—	I2BB
RU16	30.16	39.69	6.35	—	I4BA	15693	30.16	52.39	11.11	—	I5B.	14295	31.00	47.00	7.00	—	I5BB
12239	30.16	39.69	6.35	—	I5BB	15693	30.16	52.39	11.11	—	I5C	—	31.00	47.00	7.00	—	I5BB
17168	30.16	40.48	7.94	—	CORT	21326	30.16	52.39	12.70	—	I5B.	—	31.00	47.00	7.00	—	I2BB
18291	30.16	41.28	6.35	—	I2BB	15927	30.16	52.39	14.29	—	I1BF	14295	31.00	47.00	7.00	—	I5BB
21306	30.16	41.28	9.53	—	I5BA	19915	30.16	53.48	12.00	17.00	I2BB	21340	31.00	47.00	7.00	—	I5BB
17669	30.16	42.86	6.35	—	F	18461	30.16	53.58	11.91	—	I5B.	21340	31.00	47.00	7.00	—	I5B.
17650	30.16	42.86	6.35	—	I4BA	21327	30.16	53.58	11.91	—	I5BB	14296	31.00	47.00	10.00	—	I5BB
15616	30.16	42.86	7.94	—	CORT	21328	30.16	53.90	11.11	—	I5BB	21341	31.00	47.00	10.00	—	I5B.
21308	30.16	42.86	7.94	—	I2BB	21329	30.16	53.90	16.67	—	I5BB	—	31.00	48.00	10.00	—	I2BB
13701	30.16	42.86	7.94	—	I2BA	17326	30.16	53.98	11.11	—	I5B.	—	31.00	50.00	8.00	—	I2BB
18362	30.16	42.86	9.52	—	I2BA	18465	30.16	53.98	16.67	—	I1FB	—	31.00	50.00	8.00	—	I2BB
13446	30.16	42.86	9.52	—	I5BA	18090	30.16	55.00	10.00	—	I5BB	16040	31.00	51.00	8.00	—	I5BB
13446	30.16	42.86	9.52	—	I5BA	18090	30.16	55.00	10.00	—	I13	12596	31.00	51.00	12.70	—	I5BA
18362	30.16	42.86	9.52	—	I5C	17955	30.16	55.56	12.70	—	I813	16569	31.00	52.00	8.00	—	I5BB
21309	30.16	42.86	9.53	—	I2BA	17085	30.16	57.15	9.52	—	I13	16569	31.00	52.00	8.00	—	I2BB
17275	30.16	44.45	9.52	—	I5BA	13648	30.16	57.15	9.52	—	I5BB	16701	31.00	57.80	19.00	—	I5BB
17275	30.16	44.45	9.52	—	I5BB	17070	30.16	57.15	12.70	—	I5BA	—	31.00	65.10	13.00	—	I2BA
17928	30.16	46.04	8.33	—	I13	17070	30.16	57.15	12.70	—	I5B.	12953	31.35	46.04	5.56	—	I5BB
21310	30.16	46.43	6.35	—	I5BA	17070	30.16	57.15	12.70	—	I5C	—	31.40	42.85	7.93	—	I2BA
13684	30.16	46.43	11.11	—	I5BA	14019	30.16	57.15	57.15	—	REPA	11195	31.50	45.00	7.10	—	I2BB
21311	30.16	46.83	11.11	—	I5BB	15352	30.16	58.74	11.91	—	I13	—	31.50	51.90	10.00	—	I2BA
17424	30.16	46.83	11.11	—	I5B.	21330	30.16	60.33	11.11	—	I5BB	—	31.50	52.00	8.50	—	I2BA
15430	30.16	47.63	4.76	—	F	19031	30.16	60.33	11.11	—	I5BA	—	31.50	52.40	10.00	—	I2BA
18181	30.16	47.63	6.35	—	I4B.	18466	30.16	60.33	12.70	—	I13	21343	31.50	72.00	10.00	—	I2BA
21312	30.16	47.63	6.35	—	I5BA	21331	30.16	60.33	12.70	—	I5BB	16788	31.50	101.60	24.20	—	TDUO
21313	30.16	47.63	9.53	—	I5BB	—	30.16	61.90	10.00	—	I5BB	11506	31.70	44.45	6.00	1.50	ESPE
18460	30.16	47.63	11.11	—	I5BB	—	30.16	61.90	10.00	—	I2BB	—	31.70	44.60	6.70	—	I2BA
18460	30.16	47.63	11.11	—	I5BA	12276	30.16	61.91	6.35	—	I4BA	16362	31.70	50.90	15.90	—	I5B.



# Retentores

Perfis - Ver Última Página



INCOVE VEDAÇÕES LTDA.

Cod.	Di	De	Ha1	Ha2	Mod	Cod.	Di	De	Ha1	Ha2	Mod	Cod.	Di	De	Ha1	Ha2	Mod
11963	31.70	53.95	6.50	—	I2BA	13305	31.75	44.45	11.11	—	I5B.	15040	31.75	50.80	11.11	—	I5B.
16963	31.70	53.95	6.50	—	I2BA	13305	31.75	44.45	11.11	—	I5BB	13251	31.75	50.80	11.11	—	I2B.
—	31.75	38.07	3.17	—	I4BB	15556	31.75	44.45	13.49	—	ESPE	15040	31.75	50.80	11.11	—	I5C
15250	31.75	38.10	3.10	—	I4BA	—	31.75	44.50	6.35	—	I2BB	17602	31.75	50.80	14.29	—	I1FB
15250	31.75	38.10	3.97	—	I4BB	—	31.75	44.50	9.52	—	I2BB	—	31.75	50.80	15.87	—	I2BA
15250	31.75	38.10	3.97	—	I4B.	17164	31.75	45.24	6.35	—	I5BB	19921	31.75	50.80	15.87	—	I1FB
15650	31.75	39.69	3.97	—	I4B.	21356	31.75	45.24	6.35	—	I5BA	19921	31.75	50.80	15.87	—	I1FB
16199	31.75	39.69	4.00	—	I4BA	18279	31.75	46.04	7.94	—	F	19921	31.75	50.80	15.87	—	I1FC
18914	31.75	39.69	15.87	—	ESPE	—	31.75	46.46	9.92	—	I2BB	18054	31.75	50.80	19.05	—	I7B.
21344	31.75	40.48	7.94	—	I2B.	17092	31.75	46.83	6.35	—	CORT	17579	31.75	50.80	41.28	—	REPA
11300	31.75	41.28	4.76	—	I4BA	21357	31.75	46.83	6.35	—	I5BB	21377	31.75	51.20	9.53	—	I5B.
20344	31.75	41.28	4.76	—	I4BA	17712	31.75	46.83	6.35	—	I5B.	15087	31.75	51.20	13.49	—	I1BF
11097	31.75	41.28	11.91	—	I5BB	18471	31.75	47.63	6.35	—	I5BA	—	31.75	52.37	6.35	—	I4BA
—	31.75	42.82	9.52	—	I5BB	18471	31.75	47.63	6.35	—	I5BA	—	31.75	52.37	12.70	—	I5BA
15031	31.75	42.86	4.76	—	I4BB	21358	31.75	47.63	7.94	—	I5BA	11375	31.75	52.39	6.35	—	I5BA
15481	31.75	42.86	4.76	—	F	18472	31.75	47.63	9.52	—	I5BB	17463	31.75	52.39	6.35	—	I5BB
15031	31.75	42.86	4.76	—	I4BB	18472	31.75	47.63	9.52	—	I5BA	17463	31.75	52.39	6.35	—	I4BB
15031	31.75	42.86	4.76	—	I4BA	18472	31.75	47.63	9.52	—	I5C	11375	31.75	52.39	6.35	—	I5BA
15031	31.75	42.86	4.76	—	I4C	18472	31.75	47.63	9.52	—	I5BB	17463	31.75	52.39	6.35	—	I4BA
13333	31.75	42.86	6.35	—	I5BB	21359	31.75	48.02	12.70	—	I5B.	17463	31.75	52.39	6.35	—	I4C
13333	31.75	42.86	6.35	—	I5BA	—	31.75	48.08	12.70	—	I5BA	13325	31.75	52.39	7.94	—	I5BB
14723	31.75	42.86	7.94	—	I2BA	19016	31.75	49.21	6.35	—	CORT	13325	31.75	52.39	7.94	—	I5BB
15034	31.75	42.86	7.94	—	I4BB	13728	31.75	49.21	7.94	—	I13	13324	31.75	52.39	9.52	—	I5B.
14723	31.75	42.86	7.94	—	I2BB	21360	31.75	49.21	9.53	—	I5BA	13324	31.75	52.39	9.52	—	I5B.
14723	31.75	42.86	7.94	—	I2BB	14054	31.75	49.21	11.11	—	I5BA	15542	31.75	52.39	11.11	—	I5BB
14723	31.75	42.86	7.94	—	I2BA	21362	31.75	49.61	10.32	—	I5BB	15542	31.75	52.39	11.11	—	I5B.
15034	31.75	42.86	9.52	—	I5BB	—	31.75	50.00	8.00	—	I5BA	15542	31.75	52.39	11.11	—	I5C
15034	31.75	42.86	9.52	—	I5BB	12913	31.75	50.01	9.52	—	I2BB	15591	31.75	53.18	19.05	—	I9B.
15034	31.75	42.86	9.52	—	I5BA	13707	31.75	50.01	11.11	—	I5BB	15513	31.75	53.58	6.35	—	I4B.
15034	31.75	42.86	9.52	—	I5BB	13707	31.75	50.01	11.11	—	I5BB	21378	31.75	53.58	6.35	—	I2BA
21346	31.75	42.86	12.70	—	I5B.	—	31.75	50.36	12.70	—	I5BA	21379	31.75	53.58	7.94	—	I5BB
—	31.75	42.87	4.68	—	I5BB	21363	31.75	50.40	7.94	—	I5BB	21380	31.75	53.58	9.53	—	I5BB
—	31.75	42.87	4.76	—	I5BA	21364	31.75	50.40	7.94	—	I2BA	21381	31.75	53.58	11.11	—	I5BB
16672	31.75	42.90	6.35	—	I5BB	21365	31.75	50.40	9.53	—	I5B.	21382	31.75	53.58	11.11	—	I5B.
—	31.75	43.40	6.35	—	I5BA	15044	31.75	50.40	11.10	—	I5B.	21383	31.75	53.58	11.91	—	I5BB
21347	31.75	43.66	7.94	—	I5BA	15044	31.75	50.40	11.10	—	I5BB	15150	31.75	53.58	11.91	—	I5B.
21348	31.75	44.05	9.13	—	I5BA	15044	31.75	50.40	11.10	—	I5B.	21384	31.75	53.58	12.70	—	I5B.
21349	31.75	44.05	9.53	—	I5B.	15044	31.75	50.40	11.10	—	I5C	—	31.75	53.97	11.11	—	I5BA
15471	31.75	44.45	4.76	—	F	21368	31.75	50.40	11.11	—	I5BB	15610	31.75	53.98	6.35	—	I4BA
13921	31.75	44.45	5.50	—	I550	21366	31.75	50.40	11.11	—	I5B.	15080	31.75	53.98	11.11	—	I5C
13365	31.75	44.45	6.35	—	I5BB	21371	31.75	50.40	11.11	—	I2BA	12675	31.75	53.98	14.29	—	I5B.
13365	31.75	44.45	6.35	—	I5BA	21372	31.75	50.40	11.11	—	I2BA	18091	31.75	53.98	15.08	—	I1BF
17117	31.75	44.45	6.35	—	I4B.	21370	31.75	50.40	11.11	—	I2B.	18155	31.75	53.98	19.05	—	I9B.
13365	31.75	44.45	6.35	—	I5BB	21373	31.75	50.40	11.91	—	I5BB	22425	31.75	54.07	6.30	—	I2BA
13919	31.75	44.45	6.35	—	I5BA	21375	31.75	50.40	12.70	—	I5BA	16220	31.75	54.30	6.35	—	I4BA
13365	31.75	44.45	6.35	—	I5BB	21374	31.75	50.40	12.70	—	I2B.	15080	31.75	54.48	11.11	—	I5BB
13366	31.75	44.45	6.35	—	I2BA	15874	31.75	50.40	15.87	—	I1BF	21385	31.75	54.77	11.51	—	I5B.
17117	31.75	44.45	6.35	—	I4BA	21376	31.75	50.40	15.88	—	I2B.	15842	31.75	55.56	12.70	—	I5BA
21351	31.75	44.45	7.00	—	I5BA	—	31.75	50.65	6.35	—	I4BA	21386	31.75	56.36	11.11	—	I5BB
13688	31.75	44.45	7.14	—	I5BA	—	31.75	50.65	6.35	—	I2BA	17008	31.75	56.36	11.11	—	I5B.
13688	31.75	44.45	7.14	—	I5BB	15530	31.75	50.80	5.00	—	I4BB	15225	31.75	57.15	6.35	—	I4BA
13306	31.75	44.45	7.94	—	I5BB	15530	31.75	50.80	6.35	—	I4B.	15225	31.75	57.15	6.35	—	I4C
12699	31.75	44.45	7.94	—	I2B.	14791	31.75	50.80	6.35	—	ESPE	—	31.75	57.15	9.52	—	I5BA
13306	31.75	44.45	7.94	—	I5BA	12486	31.75	50.80	6.35	—	I5B.	13355	31.75	57.15	9.52	—	I5BA
21353	31.75	44.45	7.94	—	I2BB	11561	31.75	50.80	6.35	—	I2BB	13355	31.75	57.15	9.52	—	I5BB
13306	31.75	44.45	7.94	—	I5BA	15530	31.75	50.80	6.35	—	I4C	21387	31.75	57.15	9.53	—	I5BA
21352	31.75	44.45	7.94	—	I5B.	16247	31.75	50.80	7.93	—	I5BB	17074	31.75	57.15	12.70	—	I5BA
12699	31.75	44.45	7.94	—	I2BA	13252	31.75	50.80	9.52	—	I5B.	17074	31.75	57.15	12.70	—	I5B.
12699	31.75	44.45	7.94	—	I2B.	13590	31.75	50.80	9.52	—	I2BA	17665	31.75	57.15	17.46	—	I1FC
21354	31.75	44.45	7.94	—	I2B.	18282	31.75	50.80	9.52	—	I7B.	14908	31.75	57.15	19.05	—	I2B
17555	31.75	44.45	9.52	—	I5BA	13590	31.75	50.80	9.53	—	I2BA	15719	31.75	57.94	6.35	—	I4BA
17555	31.75	44.45	9.52	—	I5BA	—	31.75	50.80	10.70	—	I2BA	—	31.75	57.96	6.35	—	I4BA
17555	31.75	44.45	9.52	—	I5B.	15040	31.75	50.80	11.11	—	I5BB	15352	31.75	58.74	11.91	—	I13
17555	31.75	44.45	9.52	—	I5B.	—	31.75	50.80	11.11	—	I5BA	21388	31.75	59.13	12.70	—	I2BA
13838	31.75	44.45	9.52	—	I2BB	13251	31.75	50.80	11.11	—	I2BA	18251	31.75	60.33	12.70	—	F
17555	31.75	44.45	9.52	—	I5C	15040	31.75	50.80	11.11	—	I5B.	18473	31.75	60.33	12.70	—	I5B.
13305	31.75	44.45	11.11	—	I5BB	15040	31.75	50.80	11.11	—	I5BB	21389	31.75	60.33	12.70	—	I2BB



# Retentores

Perfis - Ver Última Página



INCOVE VEDAÇÕES LTDA.

Cod.	Di	De	Ha1	Ha2	Mod	Cod.	Di	De	Ha1	Ha2	Mod	Cod.	Di	De	Ha1	Ha2	Mod
18030	31.75	60.33	12.70	—	I13	—	32.00	45.00	6.50	—	I4BB	21415	32.00	50.00	12.00	—	I5B.
—	31.75	60.50	12.70	—	I2BB	—	32.00	45.00	6.50	—	I4BB	14305	32.00	50.00	12.00	—	I5B.
17546	31.75	61.91	9.52	—	I4BA	14299	32.00	45.00	7.00	—	I5BB	16854	32.00	50.80	8.80	—	ESPE
17546	31.75	61.91	9.52	—	I4BA	—	32.00	45.00	7.00	—	I2BB	16433	32.00	51.00	6.40	—	I5BA
15363	31.75	61.91	11.11	—	I13	—	32.00	45.00	7.00	—	I2BB	—	32.00	52.00	1.00	—	I2BB
18474	31.75	61.91	11.91	—	I5BA	—	32.00	45.00	7.00	—	I2BB	13184	32.00	52.00	5.00	—	I4BB
18475	31.75	61.91	19.84	—	I1BF	14299	32.00	45.00	7.00	—	I5BA	13184	32.00	52.00	5.00	—	I4BB
17083	31.75	63.10	12.70	—	I13	—	32.00	45.00	7.00	—	I2BB	11945	32.00	52.00	6.50	—	I5BA
18476	31.75	63.50	6.35	—	I4BA	14299	32.00	45.00	7.00	—	I5BB	21416	32.00	52.00	6.50	—	I2BA
19034	31.75	63.50	11.11	—	I5BA	21406	32.00	45.00	7.00	—	I5BA	—	32.00	52.00	7.00	—	I2BB
19034	31.75	63.50	11.11	—	I5B.	25436	32.00	45.00	8.00	—	I5BB	—	32.00	52.00	7.00	—	I2BB
16714	31.75	63.50	12.70	—	I2BA	11754	32.00	45.00	8.00	—	I2BB	11186	32.00	52.00	7.00	—	I5BB
15979	31.75	65.09	4.76	—	I55	22438	32.00	45.00	9.00	—	ESPE	11163	32.00	52.00	7.00	8.50	I7BB
15712	31.75	65.09	12.70	—	I13	21407	32.00	45.00	9.50	—	I2B.	11254	32.00	52.00	7.50	—	I5BB
17976	31.75	65.88	10.32	—	I13	—	32.00	45.00	10.00	—	I2BB	21417	32.00	52.00	8.00	—	I2BB
21390	31.75	66.68	9.53	—	I5BB	21408	32.00	45.00	10.00	—	I2BA	13499	32.00	52.00	9.00	—	I5B.
15276	31.75	68.26	7.93	—	I5BA	14099	32.00	45.00	12.00	—	I5BA	—	32.00	52.00	9.00	—	I2BB
15276	31.75	68.26	7.93	—	I55B	—	32.00	46.00	6.00	—	I2BB	13499	32.00	52.00	9.00	—	I5B.
15276	31.75	68.26	7.93	—	ESPE	—	32.00	46.00	7.00	—	I2BB	21418	32.00	52.00	9.00	—	I5BB
21391	31.75	69.06	11.91	—	I5BB	—	32.00	46.00	8.00	—	I2BB	13499	32.00	52.00	9.00	—	I5BA
18477	31.75	69.06	11.91	—	I5C	22557	32.00	46.00	8.00	—	I4BA	13185	32.00	52.00	9.50	—	I4BA
13943	31.75	69.85	8.73	—	I5BA	—	32.00	47.00	6.00	—	I2BB	13185	32.00	52.00	9.50	—	I4BA
16200	31.75	69.85	9.52	—	I5BB	11657	32.00	47.00	7.00	—	I2BB	14306	32.00	52.00	10.00	—	I5BB
21393	31.75	72.23	11.91	—	I5BB	11640	32.00	47.00	7.00	—	I5BB	21420	32.00	52.00	10.00	—	I5BA
17219	31.75	72.23	11.91	—	I5BA	11640	32.00	47.00	7.00	—	I5BA	21419	32.00	52.00	10.00	—	I5B.
18478	31.75	80.96	11.11	—	I5B.	—	32.00	47.00	8.00	—	I2BB	13581	32.00	52.00	10.00	—	I2BB
21394	31.75	80.96	11.11	—	I5BB	21409	32.00	47.00	8.00	—	I5BB	21421	32.00	52.00	11.50	—	I5B.
21395	31.75	84.70	11.91	—	I5B.	21410	32.00	47.00	9.00	—	I5BA	13183	32.00	52.00	12.00	—	I2BB
12083	31.75	88.90	19.84	—	I7BB	—	32.00	47.00	10.00	—	I5BB	21424	32.00	52.00	12.00	—	I5B.
21396	31.75	95.25	12.70	—	I5BB	—	32.00	47.00	10.00	—	I2BB	13183	32.00	52.00	12.00	—	I2BB
18479	31.75	95.25	12.70	—	I5B.	—	32.00	47.00	10.00	—	I2BB	21422	32.00	52.00	12.00	—	I2BA
—	31.78	53.97	7.90	—	I5BA	12224	32.00	47.00	10.00	—	I2BB	21425	32.00	52.00	12.70	—	I5BB
20130	31.80	54.00	9.50	—	I5JM	12224	32.00	47.00	10.00	—	I2BB	14868	32.00	52.00	13.00	—	I5BB
15302	31.90	44.00	9.00	—	I5BA	12994	32.00	47.00	10.00	—	I5BA	11464	32.00	52.50	11.00	—	I5BB
—	32.00	40.00	5.00	—	I2BB	12994	32.00	47.00	10.00	—	I5B.	12536	32.00	53.50	19.00	—	I9B.
21398	32.00	40.00	7.00	—	I5BA	12224	32.00	47.00	10.00	—	I2BB	13100	32.00	54.50	12.00	16.00	I2BB
21399	32.00	40.00	7.00	—	I2BB	21411	32.00	47.00	10.00	—	I2BA	11483	32.00	55.00	7.00	—	I5BA
—	32.00	40.00	8.00	—	I5BB	—	32.00	47.00	10.00	—	I2BB	—	32.00	55.00	8.00	—	I5BB
14297	32.00	40.00	10.00	—	I5BB	12224	32.00	47.00	10.00	—	I2BB	21426	32.00	55.00	8.00	—	I5BA
14297	32.00	40.00	10.00	—	I5BB	—	32.00	47.00	10.00	—	I2BB	17708	32.00	55.00	8.00	—	I13
12153	32.00	42.00	4.00	—	I4BA	—	32.00	47.00	10.00	—	I2BB	—	32.00	55.00	9.50	—	I5BB
12153	32.00	42.00	4.00	—	I4SD	—	32.00	47.00	10.00	—	I2BB	—	32.00	55.00	10.00	—	I2BB
—	32.00	42.00	7.00	—	I2BA	—	32.00	48.00	7.00	—	I2BB	21427	32.00	55.00	10.00	—	I5BB
—	32.00	42.00	7.00	—	I2BB	—	32.00	48.00	7.00	—	I2BB	21397	32.00	55.00	10.00	—	I5B.
13045	32.00	42.00	7.00	—	I2BA	—	32.00	48.00	8.00	—	I2BB	14307	32.00	55.00	10.00	—	I5B.
13155	32.00	42.00	7.00	—	I5BA	21412	32.00	48.00	8.00	—	I5BB	14307	32.00	55.00	10.00	—	I5C
13155	32.00	42.00	7.00	—	I5BA	14301	32.00	48.00	10.00	—	I5BA	12621	32.00	55.00	12.00	—	I5BB
21401	32.00	42.00	7.00	—	I2BA	14301	32.00	48.00	10.00	—	I5C	21428	32.00	55.00	12.00	—	I5B.
13155	32.00	42.00	7.00	—	I5BB	13665	32.00	48.00	11.00	—	I5BA	—	32.00	56.00	8.00	—	I2BB
16340	32.00	42.00	10.00	—	I2BA	—	32.00	50.00	6.00	—	I2BB	—	32.00	56.00	10.00	—	I2BA
21402	32.00	42.00	10.00	—	I5BA	21413	32.00	50.00	7.00	—	I5BA	12924	32.00	56.00	10.00	—	I5BB
16106	32.00	42.70	6.30	—	I2BA	13831	32.00	50.00	7.00	—	I5B.	14309	32.00	56.00	10.00	—	I2BB
12655	32.00	43.00	5.00	—	I4BB	—	32.00	50.00	8.00	—	I5BB	14309	32.00	56.00	10.00	—	I2BB
21403	32.00	43.00	5.50	—	I5BB	14302	32.00	50.00	8.00	—	I5BB	14309	32.00	56.00	10.00	—	I2BB
11915	32.00	43.00	6.00	—	I2BB	14302	32.00	50.00	8.00	—	I5BB	—	32.00	56.00	12.00	—	I5BB
18035	32.00	43.00	7.00	—	I5BB	14302	32.00	50.00	8.00	—	I5BA	21430	32.00	56.00	12.00	—	I5B.
16729	32.00	43.00	7.00	—	I5BB	22451	32.00	50.00	8.00	—	I2BB	21431	32.00	58.00	7.00	—	I2BA
—	32.00	44.00	7.00	—	I2BB	14302	32.00	50.00	8.00	—	I5BA	—	32.00	58.00	12.00	—	I2BA
21404	32.00	44.00	8.00	—	I5BB	—	32.00	50.00	10.00	—	I5BB	—	32.00	58.00	12.00	—	I2BB
14298	32.00	44.00	8.00	—	I5BA	—	32.00	50.00	10.00	—	I2BB	—	32.00	60.00	8.00	—	I2BB
12830	32.00	44.00	8.00	—	I2BB	—	32.00	50.00	10.00	—	I2BB	16221	32.00	61.90	9.50	—	I2BB
—	32.00	44.00	9.00	—	I5BA	14304	32.00	50.00	10.00	—	I5BB	16740	32.00	62.00	7.00	—	I5BB
21405	32.00	44.00	9.00	—	I5BA	14304	32.00	50.00	10.00	—	I5BA	11142	32.00	62.00	8.00	9.50	I7BB
16445	32.00	44.50	12.00	—	I2BB	14304	32.00	50.00	10.00	—	I5B.	12691	32.00	62.00	10.00	—	I5BA
12598	32.00	45.00	4.00	—	I4BA	21414	32.00	50.00	10.00	—	I2BB	21432	32.00	62.00	10.00	—	I5B.
12359	32.00	45.00	6.00	—	I5BB	14303	32.00	50.00	10.00	—	I13	12989	32.00	65.00	10.00	—	I2BB
12359	32.00	45.00	6.00	—	I5BB	14305	32.00	50.00	12.00	—	I5B.	12989	32.00	65.00	10.00	—	I2BB



# Retentores

Perfis - Ver Última Página



INCOVE VEDAÇÕES LTDA.

Cod.	Di	De	Ha1	Ha2	Mod	Cod.	Di	De	Ha1	Ha2	Mod	Cod.	Di	De	Ha1	Ha2	Mod
21433	32.00	65.00	12.00	—	15B.	13027	33.00	52.00	10.00	—	15BB	21464	33.34	49.21	9.53	—	15BB
12989	32.00	65.00	12.00	—	12BB	21450	33.00	52.00	10.00	—	15BA	18069	33.34	49.50	12.00	—	12B.
—	32.00	65.00	13.00	—	12BA	21451	33.00	52.00	10.00	—	15B.	18895	33.34	49.61	6.35	—	15BA
16963	32.00	65.00	13.00	—	12BA	21452	33.00	52.00	11.00	—	15BA	21465	33.34	50.01	9.53	—	12BA
12987	32.00	65.00	18.00	—	15BA	13813	33.00	52.00	12.00	—	12BA	18070	33.34	50.01	10.00	15.00	12BA
21434	32.00	68.00	7.00	—	15BB	13813	33.00	52.00	12.00	—	12BA	18070	33.34	50.01	10.00	—	12BB
21435	32.00	70.00	12.00	—	15BB	13813	33.00	52.00	13.00	—	12BA	13474	33.34	50.80	7.94	—	12BA
—	32.00	72.00	10.00	—	15B.	11046	33.00	54.00	7.00	—	15BB	21466	33.34	50.80	8.33	—	15BB
S2270	32.00	72.00	10.00	—	15B.	21453	33.00	54.00	13.00	—	15BA	21467	33.34	50.80	9.53	—	12BA
21436	32.00	90.00	13.00	—	15BB	14300	33.00	55.00	8.00	—	15BB	19032	33.34	50.80	11.11	—	15BB
16480	32.00	152.00	40.00	—	TDUO	14300	33.00	55.00	8.00	—	15BA	19032	33.34	50.80	11.11	—	15BB
15592	32.15	46.83	7.94	—	CORT	—	33.00	55.00	8.00	—	15B.	19032	33.34	50.80	11.11	—	15B
—	32.16	41.61	14.28	—	12BA	—	33.00	55.00	9.50	—	12BB	21468	33.34	50.80	11.11	—	12BB
—	32.30	51.40	9.92	—	15BA	14312	33.00	55.00	15.00	—	13B.	19032	33.34	50.80	11.11	—	15C
18343	32.45	50.80	11.11	—	15BB	—	33.00	55.00	15.50	—	12BA	13657	33.34	50.80	12.70	—	15BA
18343	32.45	50.80	11.11	—	15BB	—	33.00	56.00	12.00	—	15BA	13303	33.34	50.80	12.70	—	12BA
15302	32.50	44.50	9.50	—	15B.	—	33.00	56.00	12.00	—	12BB	21469	33.34	50.80	12.70	—	12BA
15302	32.50	44.50	9.50	—	15BA	21454	33.00	56.00	12.00	—	15BA	15271	33.34	50.80	12.70	—	11FB
21437	32.54	44.45	9.53	—	15B.	14313	33.00	57.00	9.00	—	15BA	12827	33.34	52.39	9.52	—	15BB
21438	32.54	47.63	11.11	—	15BA	11879	33.00	57.00	9.50	—	15BB	21470	33.34	52.39	11.11	—	15BB
18480	32.54	50.40	6.35	—	14B.	11879	33.00	57.00	9.50	—	15BB	17038	33.34	52.39	11.11	—	15B.
—	32.54	50.80	11.11	—	15BB	—	33.00	59.00	11.00	—	12BB	17038	33.34	52.39	11.11	—	15B.
—	32.54	51.41	9.92	—	15BA	21455	33.00	60.00	12.00	—	15B.	11025	33.34	52.39	11.90	—	15BB
21439	32.54	51.59	12.70	—	15BB	13154	33.00	69.50	6.40	—	15BA	11025	33.34	52.39	12.70	—	15BA
15303	32.54	51.59	12.70	—	15C	12981	33.00	80.00	9.50	—	12BA	17775	33.34	52.39	15.87	—	19BC
18267	32.54	53.18	28.58	—	SANF	16726	33.30	38.10	6.35	—	12BA	21472	33.34	53.39	7.94	—	15BB
21440	32.54	69.45	7.94	—	15BA	12287	33.30	46.20	7.00	—	15BB	13206	33.34	53.58	7.94	—	12B.
15287	32.54	130.20	27.28	—	113	12287	33.30	46.20	7.00	—	15BB	21474	33.34	53.58	9.53	—	15BB
—	33.00	42.50	8.00	—	15BB	12288	33.30	46.20	8.60	—	12BB	21473	33.34	53.58	9.53	—	12BA
RU15	33.00	44.00	8.00	—	12BA	16308	33.30	54.00	11.00	—	12B.	21475	33.34	53.58	11.11	—	15BA
—	33.00	44.00	10.00	—	12BB	—	33.30	69.40	7.90	—	15BA	21476	33.34	53.58	11.11	—	15B.
16143	33.00	44.50	5.30	—	ESPE	13154	33.30	69.40	7.90	—	15BA	12820	33.34	53.98	9.52	—	15BB
—	33.00	45.00	5.00	—	12BB	—	33.33	46.46	9.52	—	15BB	14028	33.34	53.98	9.52	—	12BA
12234	33.00	45.00	7.00	—	15BB	—	33.33	50.80	11.90	—	15BA	15171	33.34	53.98	11.11	—	15BA
12234	33.00	45.00	7.00	—	15BB	—	33.33	51.20	14.00	—	15BA	15171	33.34	53.98	11.11	—	15C
21441	33.00	45.00	7.00	—	15BA	—	33.33	57.00	6.35	—	14BA	18482	33.34	53.98	16.67	—	11FB
—	33.00	46.00	8.00	—	12BB	—	33.33	57.15	8.00	—	12BA	17433	33.34	54.17	11.91	—	15C
12984	33.00	46.00	12.00	—	12BB	—	33.33	57.15	12.70	—	15BA	12683	33.34	57.15	6.35	—	15BB
—	33.00	47.00	8.00	—	12BB	—	33.33	57.96	6.35	—	14BA	13659	33.34	57.15	9.52	—	15BA
—	33.00	49.20	10.50	—	15BB	—	33.33	60.27	12.30	—	15BA	21477	33.34	57.15	9.53	—	12BB
—	33.00	50.00	6.00	—	15BB	18992	33.34	41.28	6.35	—	14BA	21478	33.34	57.15	12.70	—	15BA
14712	33.00	50.00	6.00	—	12BB	13426	33.34	42.86	7.94	—	15BA	15325	33.34	57.15	12.70	—	15C
14712	33.00	50.00	6.00	—	15BB	13426	33.34	42.86	7.94	—	15BA	17578	33.34	57.94	6.35	—	14BA
14057	33.00	50.00	6.00	—	12BB	17922	33.34	42.86	9.52	—	14C	21479	33.34	57.94	12.70	—	15BB
14712	33.00	50.00	6.00	—	15BB	18481	33.34	44.45	4.76	—	15BB	17370	33.34	57.94	12.70	—	15B.
—	33.00	50.00	8.00	—	15BA	13613	33.34	44.45	7.94	—	14B.	15676	33.34	59.53	11.51	—	113
13080	33.00	50.00	8.00	—	15BA	20250	33.34	44.45	8.73	—	15BB	18483	33.34	60.33	6.35	—	14BA
21442	33.00	50.00	8.00	—	15BA	21456	33.34	46.04	6.99	—	15BB	19952	33.34	60.33	9.52	—	CORT
21443	33.00	50.00	8.00	—	15B.	21457	33.34	46.04	8.60	—	12BB	15415	33.34	60.33	12.70	—	113
21444	33.00	50.00	8.00	—	12BB	12360	33.34	46.43	9.52	—	15BA	21480	33.34	60.33	12.70	—	15BB
13080	33.00	50.00	8.00	—	15BA	12360	33.34	46.43	9.52	—	15BA	15494	33.34	60.33	12.70	—	15BA
11292	33.00	50.00	8.00	—	15BB	21458	33.34	46.43	9.53	—	15BB	18484	33.34	61.91	12.70	—	15BA
—	33.00	50.00	10.00	—	12BB	15462	33.34	46.43	11.11	—	15BB	13475	33.34	63.50	9.52	—	15BA
13035	33.00	50.00	10.00	—	15BB	21459	33.34	47.00	11.11	—	15BA	19033	33.34	63.50	11.11	—	15B.
21445	33.00	50.00	10.00	—	15B.	11766	33.34	47.63	6.35	—	15BA	19033	33.34	63.50	11.11	—	15C
—	33.00	50.00	12.00	—	12BB	15715	33.34	47.63	7.94	—	CORT	15313	33.34	65.09	12.70	—	113
14310	33.00	51.00	9.00	—	12BA	17287	33.34	47.63	11.11	—	15BB	17984	33.34	66.28	6.35	—	113
21445	33.00	51.00	9.50	—	15BB	21460	33.34	47.63	11.11	—	15B.	21482	33.34	66.28	6.35	—	15BB
21446	33.00	51.90	14.00	—	12BB	17287	33.34	47.63	11.11	—	15BA	19035	33.34	66.68	11.11	—	15B.
—	33.00	52.00	3.00	12.00	ESPE	17287	33.34	47.63	11.11	—	15B.	21483	33.34	66.68	11.11	—	15BB
14311	33.00	52.00	6.00	—	15BB	16320	33.34	47.63	15.87	—	15BB	17679	33.34	66.68	11.91	—	ESPE
14311	33.00	52.00	6.00	—	15BB	17944	33.34	47.63	15.87	—	11BF	15696	33.34	68.26	9.52	—	113
21447	33.00	52.00	6.00	—	15BB	17944	33.34	47.63	15.87	—	11FC	17655	33.34	68.26	14.29	—	113
21448	33.00	52.00	7.00	—	15BB	21462	33.34	48.02	8.73	—	15BB	15285	33.34	68.26	17.46	—	ESPE
17947	33.00	52.00	9.00	—	113	12361	33.34	48.42	7.94	—	15BA	12362	33.34	68.48	10.00	—	14BA
—	33.00	52.00	10.00	—	12BB	21463	33.34	49.21	6.35	—	15BA	21484	33.34	69.06	7.94	—	15BA
—	33.00	52.00	10.00	—	12BB	13436	33.34	49.21	9.52	—	12BB	18485	33.34	69.06	12.70	—	113





# Retenfores

Perfis - Ver Última Página



INCOVE VEDAÇÕES LTDA.

Cod.	Di	De	Ha1	Ha2	Mod	Cod.	Di	De	Ha1	Ha2	Mod	Cod.	Di	De	Ha1	Ha2	Mod
21485	33.34	69.45	6.35	—	I5BA	14317	34.00	72.00	14.00	—	I2BB	17504	34.93	47.63	6.35	—	F
16365	33.34	69.45	6.35	—	I2B.	14317	34.00	72.00	14.00	—	I2B.	13260	34.93	47.63	6.35	—	I5BB
17393	33.34	69.85	7.94	—	I4BA	14317	34.00	72.00	14.00	—	I2BB	13260	34.93	47.63	6.35	—	I5BA
18007	33.34	69.85	11.11	—	I13	22532	34.11	54.07	9.52	—	I2BA	11118	34.93	47.63	6.35	—	I2BB
15353	33.34	71.44	6.35	—	F	—	34.13	47.60	11.11	—	I5BA	11118	34.93	47.63	6.35	—	I2BA
19029	33.34	73.03	11.90	—	I5BB	21500	34.13	47.63	7.94	—	I5BB	16858	34.93	47.63	7.94	—	I5BB
17084	33.34	73.03	12.70	—	I5BB	21501	34.13	49.21	9.53	—	I5BB	15970	34.93	47.63	7.94	—	ESPE
17961	33.34	74.61	9.52	—	I5B.	21502	34.13	49.21	9.53	—	I5BA	19014	34.93	47.63	8.73	—	I2B.
21486	33.34	76.20	12.70	—	I5BB	17403	34.13	53.18	12.70	—	I5BB	17015	34.93	47.63	9.50	—	I5B.
18486	33.34	76.20	12.70	—	I5BA	17403	34.13	53.18	12.70	—	I5BA	17015	34.93	47.63	9.50	—	I5C
14040	33.34	76.20	12.70	14.29	I21	21504	34.13	53.58	11.91	—	I5BB	13351	34.93	47.63	9.52	—	I5BB
15280	33.34	87.31	16.67	—	I55B	21503	34.13	53.58	11.91	—	I5BA	21519	34.93	47.63	9.53	—	I5B.
15280	33.34	87.31	16.67	—	I5BA	17039	34.13	53.98	11.11	—	I5B.	21518	34.93	47.63	9.53	—	I2BB
16867	33.35	53.97	7.95	—	I5B.	21505	34.13	53.98	11.11	—	I5BB	17015	34.93	47.63	11.11	—	I5BA
11313	33.40	52.20	8.50	—	I5BB	15713	34.13	59.53	11.51	—	I13	17015	34.93	47.63	11.11	—	I5B.
16168	33.50	41.40	6.60	—	I5BB	21506	34.13	60.33	12.70	—	I5BB	18487	34.93	49.21	6.35	—	I5BA
—	34.00	39.00	3.00	—	I4BB	17559	34.13	60.33	12.70	—	I5B.	21520	34.93	49.21	7.94	—	I5BA
12015	34.00	42.00	7.00	—	I5BA	15674	34.13	68.26	9.52	—	ESPE	18295	34.93	49.21	9.52	—	I5BB
16525	34.00	43.00	6.35	—	I5BB	11342	34.50	51.00	8.20	—	I5BA	18295	34.93	49.21	9.52	—	I5BA
21487	34.00	43.00	10.00	—	I5BB	—	34.85	46.43	11.11	—	I2BA	18295	34.93	49.21	9.52	—	I5C
16250	34.00	43.00	14.00	—	I4BA	—	34.85	54.00	7.10	—	I2BA	21521	34.93	49.21	9.53	—	I5BA
RU15	34.00	45.00	7.00	—	I5BB	—	34.85	72.00	12.00	—	I2BB	—	34.93	49.47	14.28	—	I2BA
20214	34.00	45.00	7.00	—	I5BA	—	34.90	47.55	8.00	—	I2BA	—	34.93	49.60	13.00	—	I2BA
12635	34.00	45.50	4.00	—	I4BB	15053	34.90	57.30	8.50	—	ESPE	18993	34.93	49.61	6.35	—	I4
14314	34.00	46.00	7.00	—	I5BB	20180	34.90	62.10	9.50	—	I2BA	21522	34.93	49.61	6.35	—	I5BB
21488	34.00	46.00	8.00	—	I5BB	—	34.90	63.00	13.00	—	I2BA	21523	34.93	49.61	6.35	—	I5BA
21489	34.00	46.00	10.00	—	I5BB	22537	34.92	47.70	7.92	—	I5BA	15990	34.93	49.61	15.87	—	I2B.
21490	34.00	46.00	10.00	—	I2BA	—	34.92	53.49	15.87	—	I2BB	21524	34.93	49.61	15.88	—	I2BA
23274	34.00	48.00	7.00	—	I2BB	21508	34.92	65.09	7.94	—	I5BB	21525	34.93	50.58	8.33	—	I5BB
23274	34.00	48.00	7.00	—	I2BB	17999	34.92	69.05	14.30	—	I5C	—	34.93	50.75	12.70	—	I5BA
21491	34.00	48.00	8.00	—	I2BB	15957	34.93	41.28	3.17	—	I4BA	18489	34.93	50.80	6.35	—	I4BA
21492	34.00	48.00	8.80	—	I5BB	18229	34.93	41.28	6.35	—	F	12775	34.93	50.80	6.35	—	I5BB
—	34.00	50.00	7.00	—	I2BB	15544	34.93	41.28	7.94	—	I4BA	12775	34.93	50.80	6.35	—	I5BB
21493	34.00	50.00	7.00	—	I5BB	14818	34.93	43.26	4.76	—	I4BA	—	34.93	50.80	7.93	—	I5BA
21494	34.00	50.00	10.00	—	I5BB	—	34.93	44.40	4.75	—	I4BB	—	34.93	50.80	7.93	—	I2BA
14315	34.00	50.00	10.00	—	I5B.	13188	34.93	44.45	3.17	—	I4BA	12664	34.93	50.80	7.94	—	I5BA
—	34.00	52.00	7.00	—	I2BB	21509	34.93	44.45	4.76	—	I5BB	21527	34.93	50.80	7.94	—	I2BA
14326	34.00	52.00	7.00	—	I5BA	12724	34.93	44.45	4.76	—	I5B.	16517	34.93	50.80	7.94	—	I2B.
—	34.00	52.00	7.50	—	I2BB	11169	34.93	44.45	5.56	—	I2BA	21528	34.93	50.80	8.33	—	I5BB
14326	34.00	52.00	7.50	—	I5BB	14691	34.93	44.45	6.35	—	I5BA	15054	34.93	50.80	8.73	—	I5BA
22573	34.00	52.00	7.50	—	I5BB	14691	34.93	44.45	6.35	—	I5BB	15054	34.93	50.80	8.73	—	I5B.
22573	34.00	52.00	7.50	—	I5BB	14691	34.93	44.45	6.35	—	I5BB	15054	34.93	50.80	8.73	—	I5BB
—	34.00	52.00	8.00	—	I5BA	21510	34.93	44.45	7.14	—	I5BA	15054	34.93	50.80	8.73	—	I5B.
21495	34.00	52.00	8.00	—	I5BA	15787	34.93	44.45	7.94	—	CORT	15054	34.93	50.80	8.73	—	I5C
11304	34.00	52.00	10.00	—	I5BB	15377	34.93	46.04	6.35	—	I5BB	11043	34.93	50.80	9.52	—	I5BB
11304	34.00	52.00	10.00	—	I5B.	15377	34.93	46.04	6.35	—	I5BA	21530	34.93	50.80	9.53	—	I5BA
21496	34.00	52.00	12.00	—	I5BB	15377	34.93	46.04	6.35	—	I5BA	21529	34.93	50.80	9.53	—	I2B.
14316	34.00	52.00	12.00	—	I5BA	21513	34.93	46.43	6.35	—	I5BA	21531	34.93	50.80	11.11	—	I5B.
14316	34.00	52.00	12.00	—	I5BA	21511	34.93	46.43	6.35	—	I5BB	17061	34.93	50.80	12.70	—	I5BA
—	34.00	54.00	8.00	—	I2BB	21514	34.93	46.43	6.35	—	I2BB	17061	34.93	50.80	12.70	—	I5BB
20378	34.00	54.00	9.50	—	I5AT	—	34.93	46.43	9.52	—	I5BB	17061	34.93	50.80	12.70	—	I5BA
20002	34.00	54.00	14.00	—	I5BB	21515	34.93	46.43	11.11	—	I5BA	17061	34.93	50.80	12.70	—	I5C
—	34.00	55.00	8.00	—	I2BB	—	34.93	46.46	7.93	—	I5BB	18488	34.93	50.80	15.87	—	I2BA
—	34.00	55.00	11.00	—	I2BB	—	34.93	46.48	4.76	—	I4BB	—	34.93	52.37	11.11	—	I5BA
20621	34.00	55.00	11.00	13.00	I2BA	—	34.93	46.60	7.54	—	I2BB	21532	34.93	52.39	6.35	—	I5BB
—	34.00	56.00	8.00	—	I2BB	17743	34.93	46.83	4.76	—	I4BB	21533	34.93	52.39	7.94	—	I5BA
11656	34.00	58.00	13.00	—	I5B.	17743	34.93	46.83	4.76	—	I4BB	16793	34.93	52.39	7.94	—	I2BA
13890	34.00	60.00	8.00	—	I5BB	14694	34.93	46.83	6.35	—	I2BB	13316	34.93	52.39	9.52	—	I5BB
—	34.00	61.90	7.54	—	I5BB	17711	34.93	46.83	6.35	—	I5BB	13316	34.93	52.39	9.52	—	I5B.
—	34.00	62.00	8.00	—	I2BB	17710	34.93	46.83	9.52	—	I5BA	13316	34.93	52.39	9.52	—	I5BB
21497	34.00	62.00	10.00	—	I5BB	15033	34.93	46.83	11.11	—	I5B.	13316	34.93	52.39	9.52	—	I5B.
14338	34.00	62.10	10.00	—	I5BB	15033	34.93	46.83	11.11	—	I5BA	15409	34.93	52.39	11.11	—	I5BA
21498	34.00	63.50	8.00	—	I5BB	15033	34.93	46.83	11.11	—	I5C	15409	34.93	52.39	11.11	—	I5B.
25413	34.00	70.00	11.00	—	I5BB	12883	34.93	47.63	4.76	—	I13	15409	34.93	52.39	11.11	—	I5C
12264	34.00	72.00	10.00	11.50	I2BB	12883	34.93	47.63	4.76	—	I13	17082	34.93	52.39	15.87	—	I13
21499	34.00	72.00	12.00	—	I5B.	21516	34.93	47.63	4.76	—	I5BB	15698	34.93	52.78	6.35	—	I5BB
—	34.00	72.00	14.00	—	I2BB	15072	34.93	47.63	6.35	—	I4BA	17406	34.93	53.18	15.87	—	I1BF





# Retentores

Perfis - Ver Última Página



INCOVE VEDAÇÕES LTDA.

Cod.	Di	De	Ha1	Ha2	Mod	Cod.	Di	De	Ha1	Ha2	Mod	Cod.	Di	De	Ha1	Ha2	Mod
17406	34.93	53.18	15.87	—	I1FC	15718	34.93	57.94	6.35	—	I4BB	17141	34.93	63.50	11.12	—	I5BA
—	34.93	53.49	12.30	—	I5BB	13337	34.93	57.94	6.35	—	I5BB	15015	34.93	63.50	12.70	—	I5B.
—	34.93	53.49	12.30	—	I2BB	15718	34.93	57.94	6.35	—	I4C	15015	34.93	63.50	12.70	—	I5BB
18490	34.93	53.58	6.35	—	I4BA	21553	34.93	57.94	9.53	—	I5BB	21564	34.93	63.50	12.70	—	I5B.
21534	34.93	53.58	7.94	—	I5BB	15750	34.93	57.94	12.00	—	I5BB	18235	34.93	63.50	12.70	—	I7B.
21535	34.93	53.58	7.94	—	I2BA	15750	34.93	57.94	12.70	—	I5BB	15015	34.93	63.50	12.70	—	I5C
21536	34.93	53.58	9.53	—	I5B.	15750	34.93	57.94	12.70	—	I5C	13123	34.93	63.50	14.29	—	I2BB
21537	34.93	53.58	9.53	—	I2BA	—	34.93	57.96	6.35	—	I4BA	13123	34.93	63.50	14.29	—	I2BB
21538	34.93	53.58	11.11	—	I5BB	15352	34.93	58.74	11.91	—	I13	13123	34.93	63.50	14.29	—	I2BB
21540	34.93	53.58	11.11	—	I5B.	15713	34.93	59.53	9.52	—	I13	—	34.93	63.55	6.35	—	I4BA
21541	34.93	53.58	11.11	—	I2B.	21554	34.93	60.33	5.56	—	I5BB	—	34.93	63.55	12.70	—	I5BB
15045	34.93	53.58	11.91	—	I5C	15364	34.93	60.33	6.35	—	F	—	34.93	63.55	12.70	—	I2BA
15045	34.93	53.58	11.91	—	I5B.	17745	34.93	60.33	6.35	—	I4BA	18202	34.93	64.20	9.53	—	I5BB
15045	34.93	53.58	11.91	—	I5C	17745	34.93	60.33	6.35	—	I4C	18202	34.93	64.20	9.53	—	I5BB
21542	34.93	53.58	12.70	—	I5B.	12363	34.93	60.33	9.52	—	I5BB	21565	34.93	65.09	9.53	—	I2BA
17217	34.93	53.58	19.05	—	I9B.	12363	34.93	60.33	9.52	—	I5B.	15313	34.93	65.09	12.70	—	I13
17213	34.93	53.58	19.05	—	I1FC	12363	34.93	60.33	9.52	—	I5B.	21566	34.93	65.09	14.29	—	I5BB
—	34.93	53.97	11.11	—	I5BB	12363	34.93	60.33	9.52	—	I5C	18495	34.93	65.09	14.29	—	I5B.
12768	34.93	53.98	7.94	—	I2BA	21555	34.93	60.33	9.53	—	I2BB	21567	34.93	66.68	12.70	—	I5B.
18239	34.93	53.98	7.94	—	I5BB	19045	34.93	60.33	11.11	—	I5B.	18496	34.93	67.07	6.35	—	I4BA
18239	34.93	53.98	7.94	—	I5BA	15039	34.93	60.33	12.70	—	I5BB	18497	34.93	67.07	12.70	—	I5B.
18239	34.93	53.98	7.94	—	I5BA	17574	34.93	60.33	12.70	—	I8BB	17563	34.93	67.07	12.70	—	I55
13259	34.93	53.98	9.52	—	I5B.	21556	34.93	60.33	12.70	—	I5BB	—	34.93	68.22	6.35	—	I4BB
18262	34.93	53.98	9.52	—	I2BB	15039	34.93	60.33	12.70	—	I5C	—	34.93	68.22	12.70	—	I5BB
18262	34.93	53.98	9.52	—	I2BA	12096	34.93	60.33	12.70	—	I2BB	15449	34.93	68.26	6.35	—	I5BB
18262	34.93	53.98	9.52	—	I2B.	15039	34.93	60.33	12.70	—	I5B.	17591	34.93	68.26	6.35	—	I4BA
15071	34.93	53.98	11.11	—	I5C	12096	34.93	60.33	12.70	—	I2C	21568	34.93	68.26	9.53	—	I2BA
15071	34.93	53.98	11.11	—	I5BB	17144	34.93	60.33	15.87	—	I3B.	15681	34.93	68.26	10.72	—	I13
15071	34.93	53.98	11.11	—	I5BA	18199	34.93	60.33	15.87	—	I55	15454	34.93	68.26	12.70	—	I5BB
13258	34.93	53.98	11.11	—	I2B.	17144	34.93	60.33	15.87	—	I3C	15454	34.93	68.26	12.70	—	I5BA
13258	34.93	53.98	11.11	—	I2B.	17722	34.93	60.33	15.87	—	I12	21569	34.93	68.26	12.70	—	I5B.
15071	34.93	53.98	11.11	—	I5C	18493	34.93	60.33	23.81	—	I9B.	15454	34.93	68.26	12.70	—	I5B.
16093	34.93	53.98	12.70	—	I5B.	—	34.93	60.50	12.70	—	I2BB	15454	34.93	68.26	12.70	—	I5C
18125	34.93	53.98	12.70	—	I1BF	—	34.93	60.50	12.70	—	I5BB	18032	34.93	68.26	15.88	—	I1FB
17106	34.93	53.98	15.87	—	I3B.	21558	34.93	60.72	12.70	—	I5BB	15285	34.93	68.26	17.46	—	ESPE
15083	34.93	53.98	16.67	—	ESPE	17248	34.93	60.72	12.70	—	I5B.	21570	34.93	69.06	9.53	—	I2BB
17146	34.93	53.98	20.64	—	I7B.	21559	34.93	61.12	13.49	—	I5BB	18498	34.93	69.06	12.70	—	I13
18491	34.93	53.98	20.64	—	I9B.	18494	34.93	61.12	13.49	—	I5BA	21571	34.93	69.06	12.70	—	I5BB
17952	34.93	55.56	6.35	—	I5BB	18494	34.93	61.12	13.49	—	I5B.	17056	34.93	69.06	12.70	—	I5B.
21543	34.93	55.56	6.35	—	I5BB	15434	34.93	61.90	6.35	—	I4BA	17989	34.93	69.85	3.18	—	F
21545	34.93	55.56	9.13	—	I5BA	15434	34.93	61.90	6.35	—	I4B.	15830	34.93	69.85	6.35	—	I4C
21546	34.93	55.56	11.91	—	I5BB	15434	34.93	61.90	6.35	—	I5BB	21572	34.93	69.85	11.11	—	I5BB
17953	34.93	55.56	12.00	—	I5BB	15434	34.93	61.90	6.35	—	I4C	21573	34.93	69.85	11.91	—	I5BB
17953	34.93	55.56	12.70	—	I5C	16314	34.93	61.90	7.50	—	I2BB	17393	34.93	69.85	11.91	—	ESPE
17953	34.93	55.56	12.70	—	I5BA	—	34.93	61.90	7.54	—	I5BB	21574	34.93	69.85	12.70	—	I5BB
17951	34.93	55.56	12.70	—	F	15363	34.93	61.90	11.11	—	I13	17314	34.93	69.85	12.70	—	I5B.
21547	34.93	55.85	9.30	—	I2BB	—	34.93	61.90	11.90	—	I5BB	18027	34.93	71.44	14.29	—	I55B
18337	34.93	57.15	6.35	—	I4B.	21560	34.93	61.91	7.94	—	I2BB	18027	34.93	71.44	14.29	—	ESPE
21548	34.93	57.15	6.35	—	I5BB	16280	34.93	61.91	11.89	—	I2BB	18027	34.93	71.44	14.29	—	I55C
21549	34.93	57.15	7.94	—	I5BA	15456	34.93	61.91	11.91	—	I5BA	21575	34.93	72.23	11.91	—	I5BB
11495	34.93	57.15	7.94	—	I2BB	15347	34.93	61.91	11.91	—	I4B.	15572	34.93	72.23	11.91	—	I5BA
16516	34.93	57.15	8.73	—	I2BA	15456	34.93	61.91	11.91	—	I5BB	15572	34.93	72.23	11.91	—	I5B.
20295	34.93	57.15	9.53	—	I7BB	21562	34.93	61.91	11.91	—	I5BA	19957	34.93	72.23	12.70	—	I13
21550	34.93	57.15	11.11	—	I5B.	15456	34.93	61.91	11.91	—	I5C	15982	34.93	72.23	19.05	—	ESPE
—	34.93	57.15	11.90	—	I5BA	21563	34.93	61.91	11.91	—	I5B.	14344	34.93	73.03	9.53	—	I5BA
21551	34.93	57.15	12.30	—	I2BB	21564	34.93	61.91	11.91	—	I2BB	21576	34.93	73.03	13.49	—	I5BB
17002	34.93	57.15	12.70	—	I5BB	15456	34.93	61.91	11.91	—	I5B.	18499	34.93	73.03	13.49	—	I5B.
17002	34.93	57.15	12.70	—	I5BA	15456	34.93	61.91	11.91	—	I5B	15896	34.93	73.82	19.05	—	CORT
17002	34.93	57.15	12.70	—	I5B.	17340	34.93	61.91	15.08	—	I3B.	18501	34.93	76.20	12.70	—	I5B.
21552	34.93	57.15	12.70	—	I2BA	—	34.93	62.03	12.70	—	I2BA	21577	34.93	76.20	12.70	—	I5BA
17002	34.93	57.15	12.70	—	I5B.	18900	34.93	62.31	19.05	—	I5BA	18500	34.93	76.20	19.05	—	I1FB
18492	34.93	57.15	14.29	—	I2BA	13123	34.93	63.00	13.00	—	I2BA	18045	34.93	79.38	11.11	—	ESPE
18492	34.93	57.15	15.00	—	I2BB	13123	34.93	63.00	13.00	—	I2BA	21578	34.93	79.38	12.70	—	I5BB
17430	34.93	57.15	26.99	—	I9C	15416	34.93	63.10	11.11	—	I13	17062	34.93	79.38	12.70	—	I5B.
—	34.93	57.40	7.93	—	I5BB	13742	34.93	63.50	7.94	—	I5BA	18053	34.93	79.38	14.29	—	ESPE
13337	34.93	57.83	6.35	—	I5BB	13742	34.93	63.50	7.94	—	I5B.	17564	34.93	79.38	15.88	—	I13
15718	34.93	57.94	6.35	—	I4BA	21507	34.93	63.50	9.53	—	I5BB	18212	34.93	79.38	26.99	—	ESPE



# Retenfores

Perfis - Ver Última Página



INCOVE VEDAÇÕES LTDA.

Cod.	Di	De	Ha1	Ha2	Mod	Cod.	Di	De	Ha1	Ha2	Mod	Cod.	Di	De	Ha1	Ha2	Mod
13695	34.93	80.17	9.53	—	I2BA	11044	35.00	47.00	7.02	—	I2BA	RB18	35.00	50.70	8.00	—	I2BA
17686	34.93	82.55	4.76	—	ESPE	14321	35.00	47.00	9.00	—	I5BB	16721	35.00	50.80	8.00	—	I2BB
18502	34.93	84.93	11.91	—	I5BB	21585	35.00	47.00	9.00	—	I5BB	16425	35.00	50.80	10.00	—	I2BA
21579	34.93	88.90	12.70	—	I5BB	14321	35.00	47.00	10.00	—	I5BB	15054	35.00	51.00	8.00	—	I5B.
18503	34.93	88.90	12.70	—	I5B.	21586	35.00	47.00	10.00	—	I5BB	15054	35.00	51.00	8.00	—	I5B.
18504	34.93	100.00	12.70	—	I5B.	14321	35.00	47.00	10.00	—	I5BA	14290	35.00	52.00	5.00	—	I5BB
17561	34.93	117.50	7.94	—	I55	11572	35.00	47.00	10.00	—	I2BB	14290	35.00	52.00	5.00	—	I5BB
17788	34.93	127.00	15.88	—	I5BA	21587	35.00	47.00	15.00	—	I5BA	14290	35.00	52.00	5.00	—	I5BB
17788	34.93	127.00	15.88	—	ESPE	—	35.00	48.00	7.00	—	I2BB	14850	35.00	52.00	5.00	—	I4BB
15287	34.93	130.20	27.78	—	ESPE	16581	35.00	48.00	7.00	—	I2BB	11873	35.00	52.00	6.00	—	I5BB
18019	34.93	171.50	44.45	—	I55B	—	35.00	48.00	8.00	—	I2BB	11685	35.00	52.00	6.00	—	I2BB
18019	34.93	171.50	44.50	—	I5BA	14739	35.00	48.00	8.00	—	I5BB	17949	35.00	52.00	7.00	—	I13
15934	34.93	174.60	57.15	—	I55	14739	35.00	48.00	8.00	—	I5BB	—	35.00	52.00	7.00	—	I2BB
16052	34.95	57.15	9.50	—	I5BB	21588	35.00	48.00	8.00	—	I5BA	11776	35.00	52.00	7.00	—	I4BA
16052	34.95	57.15	9.50	—	I5B.	15602	35.00	48.00	8.00	—	I13	14326	35.00	52.00	7.00	—	I5BB
12835	34.95	63.00	14.00	—	I550	14322	35.00	48.00	10.00	—	I5BA	14326	35.00	52.00	7.00	—	I5BA
12835	34.95	70.50	14.00	—	I55B	14322	35.00	48.00	10.00	—	I5BB	14326	35.00	52.00	7.00	—	I5BB
16372	34.96	47.63	9.53	—	I2BB	14322	35.00	48.00	10.00	—	I5C	16470	35.00	52.00	7.50	—	I4BA
12336	35.00	40.00	21.00	—	I4B.	—	35.00	48.00	10.50	—	ESPE	12763	35.00	52.00	7.50	—	I5B.
18269	35.00	41.25	2.50	—	I4BA	16171	35.00	48.00	10.50	—	I2BB	—	35.00	52.00	8.00	—	I2BB
18269	35.00	41.25	2.50	—	ESPE	12979	35.00	48.00	11.00	—	I2BB	—	35.00	52.00	8.80	—	I5BA
13833	35.00	41.50	6.50	—	I4BA	14323	35.00	48.00	12.00	—	I5BB	—	35.00	52.00	9.00	—	I2BB
12154	35.00	42.00	4.00	—	I4BB	14323	35.00	48.00	12.00	—	I5BA	21598	35.00	52.00	9.00	—	I5BB
12154	35.00	42.00	4.00	—	I4BA	14323	35.00	48.00	12.00	—	I5BB	12629	35.00	52.00	9.00	—	I5BA
12154	35.00	42.00	4.00	—	I4BA	14323	35.00	48.00	12.00	—	I5BA	12629	35.00	52.00	9.00	—	I5B.
16489	35.00	42.00	5.00	—	I5BB	12991	35.00	48.00	13.00	—	I2BB	20190	35.00	52.00	9.00	—	I2B.
16489	35.00	42.00	5.00	—	I5BB	—	35.00	49.00	6.00	—	I2BB	—	35.00	52.00	10.00	—	I2BB
20019	35.00	42.10	4.00	—	I5BA	—	35.00	49.00	6.00	—	I2BB	14327	35.00	52.00	10.00	—	I5BA
11691	35.00	42.70	11.00	—	I5BB	11414	35.00	49.00	8.00	—	I4BB	14327	35.00	52.00	10.00	—	I5BB
11904	35.00	43.00	4.50	—	I4BB	—	35.00	50.00	7.00	—	I2BB	14327	35.00	52.00	10.00	—	I5BB
16815	35.00	43.00	7.00	—	I5BB	11438	35.00	50.00	7.00	—	I5BB	14327	35.00	52.00	10.00	—	I5BB
16627	35.00	44.00	6.30	—	I2BB	11438	35.00	50.00	7.00	—	I5BA	14327	35.00	52.00	10.00	—	I5B.
11507	35.00	44.00	7.00	—	I5BB	11438	35.00	50.00	7.00	—	I5B.	21599	35.00	52.00	10.00	—	I2BB
—	35.00	44.50	7.00	—	I5BA	11438	35.00	50.00	7.00	—	I5BB	11677	35.00	52.00	10.00	—	I2BA
12155	35.00	45.00	4.00	—	I4BA	13113	35.00	50.00	8.00	—	I5BB	14327	35.00	52.00	10.00	—	I5BB
14319	35.00	45.00	7.00	—	I5BB	—	35.00	50.00	8.00	—	I5BB	14327	35.00	52.00	10.00	—	I5BB
—	35.00	45.00	7.00	—	I2BB	—	35.00	50.00	8.00	—	I2BB	14876	35.00	52.00	12.00	—	I2BB
14319	35.00	45.00	7.00	—	I5BB	—	35.00	50.00	8.00	—	I2BB	14876	35.00	52.00	12.00	—	I2BB
14319	35.00	45.00	7.00	—	I5BA	—	35.00	50.00	8.00	—	I2BB	14328	35.00	52.00	12.00	—	I5BB
14319	35.00	45.00	7.00	—	I5BB	—	35.00	50.00	8.00	—	I2BB	21600	35.00	52.00	12.00	—	I5BA
21580	35.00	45.00	7.00	—	I5BA	12791	35.00	50.00	8.00	—	I2BB	14328	35.00	52.00	12.00	—	I5B.
14319	35.00	45.00	7.00	—	I5BB	13113	35.00	50.00	8.00	—	I5BB	21601	35.00	52.00	12.00	—	I2BA
12752	35.00	45.00	8.00	—	I5BA	—	35.00	50.00	8.00	—	I2BB	16177	35.00	52.00	12.00	—	I7BB
—	35.00	45.00	10.00	—	I2BB	21590	35.00	50.00	8.00	—	I2BB	22434	35.00	52.00	12.00	—	I5BB
25389	35.00	45.00	10.00	—	I7BA	21591	35.00	50.00	9.00	—	I5B.	11134	35.00	52.00	12.00	—	I12B
12868	35.00	45.00	10.00	—	I4BA	—	35.00	50.00	10.00	—	I2BB	—	35.00	52.37	11.11	—	I5BA
21581	35.00	45.00	10.00	—	I5BB	14324	35.00	50.00	10.00	—	I5BA	22552	35.00	52.50	6.15	—	I5B.
21582	35.00	45.00	12.00	—	I5BB	14324	35.00	50.00	10.00	—	I5BB	14329	35.00	52.50	8.00	—	I5BB
14318	35.00	45.70	5.60	—	ESPE	14324	35.00	50.00	10.00	—	I5BB	14330	35.00	52.50	12.00	—	I5B.
—	35.00	46.00	7.00	—	I2BB	14324	35.00	50.00	10.00	—	I5BB	11620	35.00	53.00	10.00	—	I5BB
12336	35.00	46.00	26.00	—	ESPE	16137	35.00	50.00	10.00	—	I5BB	—	35.00	53.50	6.50	—	I4BA
16323	35.00	46.00	26.00	—	ESPE	21592	35.00	50.00	10.00	—	I5BA	20571	35.00	54.00	7.00	—	I5BB
—	35.00	46.45	6.40	—	I2BB	14324	35.00	50.00	10.00	—	I5B.	—	35.00	54.00	8.00	—	I2BB
12560	35.00	46.50	5.00	—	I4BB	16789	35.00	50.00	10.00	—	I2BB	—	35.00	54.00	8.00	—	I2BB
21583	35.00	47.00	6.00	—	I5BA	16137	35.00	50.00	10.00	—	I2BB	22533	35.00	54.00	8.00	—	I5BA
11294	35.00	47.00	6.00	—	I5B.	21593	35.00	50.00	10.00	—	I2B.	16835	35.00	54.00	10.00	15.00	I2BB
21584	35.00	47.00	6.35	—	I5BB	14324	35.00	50.00	10.00	—	I5BA	16821	35.00	54.00	10.00	—	I5BB
14320	35.00	47.00	7.00	—	I5BA	14324	35.00	50.00	10.00	—	I5BB	16835	35.00	54.00	10.00	15.00	I2BB
14320	35.00	47.00	7.00	—	I5BA	14324	35.00	50.00	10.00	—	I5BB	11612	35.00	54.00	10.00	—	I2BB
11044	35.00	47.00	7.00	—	I2BB	16789	35.00	50.00	10.00	—	I2BB	12316	35.00	54.00	15.00	—	I2BB
14320	35.00	47.00	7.00	—	I5BA	—	35.00	50.00	11.00	—	I2BB	12316	35.00	54.00	15.00	—	I2BB
11044	35.00	47.00	7.00	—	I2BB	11487	35.00	50.00	11.00	—	I5BB	—	35.00	54.55	10.50	—	I5BB
14320	35.00	47.00	7.00	—	I5JM	21595	35.00	50.00	12.00	—	I5B.	—	35.00	55.00	8.00	—	I2BB
14320	35.00	47.00	7.00	—	I5BB	21594	35.00	50.00	12.00	—	I2B.	12238	35.00	55.00	8.00	—	I5BB
14320	35.00	47.00	7.00	—	I5BA	12308	35.00	50.00	12.20	7.00	ESPE	12238	35.00	55.00	8.00	—	I5BB
22505	35.00	47.00	7.00	—	I2BB	14289	35.00	50.00	16.00	10.00	I5BA	21602	35.00	55.00	8.00	—	I2BB
14320	35.00	47.00	7.00	—	I5B.	21596	35.00	50.00	16.00	—	I5B.	12779	35.00	55.00	9.00	—	I2BB



# Retentores

Perfis - Ver Última Página



INCOVE VEDAÇÕES LTDA.

Cod.	Di	De	Ha1	Ha2	Mod	Cod.	Di	De	Ha1	Ha2	Mod	Cod.	Di	De	Ha1	Ha2	Mod
14331	35.00	55.00	10.00	—	I2BB	12590	35.00	60.00	—	—	I5BA	14342	35.00	72.00	10.00	—	I5C
14331	35.00	55.00	10.00	—	I5BB	—	35.00	60.30	9.50	—	I2BA	—	35.00	72.00	12.00	—	I2BA
14331	35.00	55.00	10.00	—	I5BA	16477	35.00	60.60	9.50	—	I2BB	21637	35.00	72.00	12.00	—	I5BA
21603	35.00	55.00	10.00	—	I5B.	21619	35.00	61.00	7.00	—	I5BB	21636	35.00	72.00	12.00	—	I5B.
21604	35.00	55.00	10.00	—	I5BB	—	35.00	61.20	14.70	—	I2BA	13127	35.00	72.00	12.00	—	I2BB
12748	35.00	55.00	11.00	—	I2BA	13696	35.00	62.00	5.00	—	I4BA	14344	35.00	73.00	10.00	—	I5JM
—	35.00	55.00	11.00	—	I2BB	21620	35.00	62.00	5.00	—	I5BA	21638	35.00	73.00	10.00	—	I5BA
14332	35.00	55.00	11.00	—	I2BA	21621	35.00	62.00	6.00	—	I2BB	14344	35.00	73.00	10.00	—	I5B.
21605	35.00	55.00	11.00	—	I5BA	—	35.00	62.00	7.00	—	I2BB	11659	35.00	75.00	10.00	—	I5BA
12748	35.00	55.00	11.00	—	I2BA	11184	35.00	62.00	7.00	—	I5BB	21639	35.00	75.00	10.00	—	I5B.
13922	35.00	55.00	11.00	—	I2BA	21622	35.00	62.00	7.00	—	I5B.	—	35.00	78.00	8.00	—	I2BB
14333	35.00	55.00	12.00	—	ESPE	11184	35.00	62.00	7.00	—	I5BB	12656	35.00	80.00	6.00	—	I5BA
12620	35.00	55.00	12.00	—	I5BB	21623	35.00	62.00	7.50	—	I5BB	12656	35.00	80.00	6.00	—	I5BA
12620	35.00	55.00	12.00	—	I5B.	21624	35.00	62.00	9.00	—	I5B.	—	35.00	80.00	8.00	—	I2BB
12748	35.00	55.15	11.00	—	I2BA	14338	35.00	62.00	10.00	—	I5B	—	35.00	80.00	9.00	—	I2BB
—	35.00	55.25	10.00	—	I2BB	14338	35.00	62.00	10.00	—	I5BA	—	35.00	80.00	10.00	—	I2BB
11834	35.00	56.00	6.00	—	I2BB	14338	35.00	62.00	10.00	—	I5BB	21641	35.00	80.00	10.00	—	I5BB
—	35.00	56.00	7.00	—	I2BB	—	35.00	62.00	10.00	—	I2BB	13801	35.00	80.00	10.00	—	I2BB
—	35.00	56.00	8.00	—	I2BB	—	35.00	62.00	10.00	—	I2BB	13801	35.00	80.00	10.00	—	I2BB
21607	35.00	56.00	8.00	—	I5BB	—	35.00	62.00	10.00	—	I2BB	21642	35.00	80.00	10.60	—	I2BB
16212	35.00	56.00	9.00	—	I2BB	14338	35.00	62.00	10.00	—	I2BB	13944	35.00	80.00	12.00	—	I5BB
16212	35.00	56.00	9.00	—	I2BB	14338	35.00	62.00	10.00	—	I5BA	13944	35.00	80.00	12.00	—	I4BB
—	35.00	56.00	9.50	—	I2BB	14338	35.00	62.00	10.00	—	I5BB	21643	35.00	80.00	12.00	—	I5BB
—	35.00	56.00	10.00	—	I2BB	14338	35.00	62.00	10.00	—	I5BA	RB06	35.00	80.00	13.00	—	I5BB
11697	35.00	56.00	10.00	—	I5BB	25374	35.00	62.00	10.00	—	I5BB	—	35.00	82.90	10.00	—	I2BB
11762	35.00	56.00	10.00	—	I2BA	14338	35.00	62.00	10.00	—	I5BA	20286	35.40	51.00	12.00	—	I2BB
11697	35.00	56.00	10.00	—	I5BB	21625	35.00	62.00	12.00	—	I5BA	12834	35.50	58.00	13.00	—	I5BB
21609	35.00	56.00	10.00	—	I5BA	—	35.00	62.00	12.00	—	I5BB	12834	35.50	58.00	13.00	—	I5B.
21608	35.00	56.00	10.00	—	I5B.	—	35.00	62.00	12.00	—	I2BB	21644	35.50	58.10	13.00	—	I2BA
11762	35.00	56.00	10.00	—	I2BB	11717	35.00	62.00	12.00	—	I2BA	13501	35.50	58.20	13.00	—	I2BA
21610	35.00	56.00	11.00	—	I5BB	21625	35.00	62.00	12.00	—	I5B.	13501	35.50	58.20	13.00	—	I2BA
—	35.00	56.00	12.00	—	I2BB	11717	35.00	62.00	12.00	—	I2BA	—	35.53	58.21	13.20	—	I2BA
—	35.00	56.00	12.00	—	I5BA	11717	35.00	62.00	12.00	—	I2B.	14013	35.72	53.98	11.11	—	ESPE
14334	35.00	56.00	12.00	—	I5BA	11717	35.00	62.00	12.00	—	I2BA	21646	35.72	61.91	12.70	—	I5BB
14334	35.00	56.00	12.00	—	I5BB	14339	35.00	63.00	10.00	—	I5JM	17581	35.72	92.08	38.89	—	I4B.
21611	35.00	56.00	12.00	—	I5BA	21626	35.00	63.00	10.00	—	I5B.	—	35.80	68.00	10.00	—	I2BA
14334	35.00	56.00	12.00	—	I5B.	13631	35.00	63.00	13.00	—	I2BB	—	35.80	68.00	12.00	—	I5BA
21612	35.00	56.00	12.00	—	I2BA	21628	35.00	63.00	14.00	—	I5BA	—	36.00	44.00	5.00	—	I2BB
13817	35.00	56.00	12.50	—	I2BA	21627	35.00	63.00	14.00	—	I2BB	16051	36.00	44.00	7.00	—	I2BA
11825	35.00	56.00	13.00	—	I5BB	—	35.00	64.00	8.00	—	I2BB	16675	36.00	44.50	12.70	—	I5BB
14335	35.00	56.00	28.00	—	I2BA	21629	35.00	64.00	10.00	—	I5BB	21647	36.00	45.00	4.00	—	I5BA
14335	35.00	56.00	28.00	—	I1FC	—	35.00	64.00	13.00	—	I2BB	—	36.00	46.00	5.00	—	I2BB
13940	35.00	56.50	10.00	—	I5BB	21630	35.00	64.50	12.50	—	I5BB	—	36.00	47.00	7.00	—	I2BB
12845	35.00	57.00	8.00	—	I5BA	—	35.00	65.00	8.00	—	I2BB	21648	36.00	47.00	7.00	—	I5BB
12845	35.00	57.00	8.00	—	I5B.	14731	35.00	65.00	10.00	—	I5BB	11744	36.00	47.00	7.00	—	I5BA
21613	35.00	57.00	9.00	—	I2BA	14731	35.00	65.00	10.00	—	I5B.	—	36.00	48.00	8.00	—	I2BB
12702	35.00	57.70	8.70	—	I5BA	—	35.00	65.00	12.00	—	I2BB	—	36.00	48.00	10.00	—	I2BA
21614	35.00	58.00	6.00	—	I5BB	14340	35.00	65.00	12.00	—	I5B.	—	36.00	48.00	10.00	—	I5BB
21615	35.00	58.00	9.20	—	I5B.	14340	35.00	65.00	12.00	—	I5B.	—	36.00	48.00	10.00	—	I5BB
—	35.00	58.00	10.00	—	I2BB	13086	35.00	68.00	6.00	—	I5BB	—	36.00	48.00	10.00	—	I2BB
14325	35.00	58.00	10.00	—	I5BB	—	35.00	68.00	8.00	—	I2BB	—	36.00	49.00	4.00	—	I2BB
14325	35.00	58.00	10.00	—	I5BB	21631	35.00	68.00	10.00	—	I5BB	—	36.00	50.00	6.50	—	I2BA
14325	35.00	58.00	10.00	—	I5BB	22549	35.00	68.00	10.00	—	I5BB	—	36.00	50.00	7.00	—	I2BB
14336	35.00	58.00	12.00	—	I5BB	14341	35.00	68.00	10.00	15.00	I1BF	—	36.00	50.00	7.00	—	I2BB
14336	35.00	58.00	12.00	—	I5BB	21632	35.00	70.00	7.00	—	I2BA	21649	36.00	50.00	7.00	—	I5BA
—	35.00	58.00	12.00	—	I5BB	—	35.00	70.00	8.00	—	I2BB	—	36.00	50.00	8.00	—	I2BB
—	35.00	58.00	12.00	—	I2BB	11648	35.00	70.00	10.00	—	I5BA	14345	36.00	50.00	9.00	—	I13
14336	35.00	58.00	12.00	—	I5BB	11648	35.00	70.00	10.00	—	I5BA	21650	36.00	50.00	9.00	—	I5B.
21617	35.00	58.00	13.00	—	I5BA	14343	35.00	70.00	12.00	—	I5BB	13748	36.00	50.00	10.00	—	I5BB
21616	35.00	58.00	13.00	—	I2BA	14343	35.00	70.00	12.00	—	I5BA	21651	36.00	50.00	10.00	—	I5BA
—	35.00	60.00	8.00	—	I2BB	21633	35.00	70.00	12.00	—	I5B.	14730	36.00	50.80	—	—	REPA
11994	35.00	60.00	8.00	—	I5BB	—	35.00	72.00	8.00	—	I2BB	11667	36.00	51.00	8.00	—	I5BA
14337	35.00	60.00	10.00	—	I5BB	21634	35.00	72.00	8.00	—	I2BB	21652	36.00	52.00	7.00	—	I5BA
14337	35.00	60.00	10.00	—	I5BA	14342	35.00	72.00	10.00	—	I5B.	13537	36.00	52.00	7.00	—	I2BB
21618	35.00	60.00	10.00	—	I5B.	21635	35.00	72.00	10.00	—	I5BB	13537	36.00	52.00	7.00	—	I2BA
12590	35.00	60.00	12.00	—	I2BA	14342	35.00	72.00	10.00	—	I5B.	13537	36.00	52.00	7.00	—	I2BB
16971	35.00	60.00	12.00	—	I9BA	11155	35.00	72.00	10.00	—	I2BB	—	36.00	52.00	8.00	—	I2BB



# Retentores

Perfis - Ver Última Página



INCOVE VEDAÇÕES LTDA.

Cod.	Di	De	Ha1	Ha2	Mod	Cod.	Di	De	Ha1	Ha2	Mod	Cod.	Di	De	Ha1	Ha2	Mod
21653	36.00	52.00	9.00	—	I5BA	12778	36.51	52.39	9.53	—	I5BB	15452	36.51	68.26	7.94	—	I4BA
—	36.00	52.00	10.00	—	I2BB	18508	36.51	52.39	9.53	—	I3B.	15452	36.51	68.26	7.94	—	I4C
21654	36.00	52.00	10.00	—	I5BB	14083	36.51	52.39	11.11	—	I5C	15681	36.51	68.26	10.32	—	I13
—	36.00	52.50	11.50	—	I2BB	13749	36.51	52.39	12.70	—	I5BA	15455	36.51	68.26	12.70	—	I5C
—	36.00	54.00	7.00	—	I5BA	18509	36.51	53.98	6.35	—	I4BA	21687	36.51	68.26	12.70	—	I5BA
—	36.00	54.00	7.00	—	I2BA	21674	36.51	53.98	6.35	—	I5BA	15455	36.51	68.26	12.70	—	I5C
—	36.00	54.00	7.00	—	I2BB	18509	36.51	53.98	6.35	—	I4C	17702	36.51	68.26	15.88	—	I55B
14346	36.00	54.00	7.00	—	I5BA	17704	36.51	53.98	7.94	—	CORT	18324	36.51	69.06	12.70	—	I13
14346	36.00	54.00	7.00	—	I5BB	11940	36.51	53.98	7.94	—	I5BB	18006	36.51	69.85	11.11	—	I5BA
21655	36.00	54.00	7.00	—	I5BA	21675	36.51	53.98	9.53	—	I5B.	21688	36.51	69.85	12.70	—	I5BB
14346	36.00	54.00	7.00	—	I5BA	21676	36.51	53.98	11.11	—	I5BB	17184	36.51	69.85	12.70	—	I5B.
—	36.00	54.00	7.50	—	I5BB	11707	36.51	53.98	11.11	—	I2BB	17184	36.51	69.85	12.70	—	I5BA
14346	36.00	54.00	8.00	—	I5BB	18505	36.51	53.98	11.11	—	I2BA	17184	36.51	69.85	13.50	—	I5BA
21656	36.00	54.00	8.00	—	I5BB	18922	36.51	55.56	6.35	—	I4BA	21689	36.51	70.25	12.70	—	I5BB
21657	36.00	54.00	8.00	—	I5BA	15709	36.51	55.56	7.94	—	F	17931	36.51	73.03	22.23	—	I7B.
14346	36.00	54.00	8.00	—	I5BA	18066	36.51	55.56	12.70	—	I5BB	17907	36.51	73.03	22.23	—	I12
—	36.00	54.00	11.00	—	I2BB	18066	36.51	55.56	12.70	—	I5BB	21690	36.51	80.17	9.53	—	I2BB
—	36.00	55.00	8.00	—	I2BB	18994	36.51	57.15	6.35	—	I5BA	15670	36.51	92.08	15.48	—	I55
21658	36.00	55.00	8.00	—	I5BB	18994	36.51	57.15	6.35	—	I5BA	12248	36.60	41.80	3.00	—	I4BA
—	36.00	56.00	8.00	—	I2BB	13356	36.51	57.15	9.53	—	I5BB	12248	36.60	41.80	3.00	—	I4BA
—	36.00	56.00	10.00	—	I2BB	21677	36.51	57.15	9.53	—	I5BA	11091	36.60	60.50	8.00	—	I5BB
14347	36.00	56.00	10.00	—	I5BB	11525	36.51	57.15	9.53	—	I2BB	21691	36.69	61.91	11.91	—	I5B.
21660	36.00	56.00	10.00	—	I5BB	17076	36.51	57.15	12.70	—	I5B.	21692	36.69	66.68	7.94	—	I2BA
21659	36.00	56.00	10.00	—	I5B.	21678	36.51	57.15	12.70	—	I5BB	21693	36.69	68.26	6.35	—	I5BA
12364	36.00	56.00	12.00	—	I5BA	17076	36.51	57.15	12.70	—	I5C	—	36.91	52.37	4.36	—	I4BA
21661	36.00	56.00	12.50	—	I2BA	17076	36.51	57.15	12.70	—	I5B.	11461	37.00	46.00	13.00	—	I5BB
16724	36.00	57.50	8.00	—	I5BB	17076	36.51	57.15	12.70	—	I5C	12156	37.00	47.00	4.00	—	I4BA
—	36.00	58.00	8.00	—	I2BB	17789	36.51	57.15	19.05	—	I1FB	13744	37.00	47.00	4.00	—	I5BB
13056	36.00	58.00	10.00	—	I5BB	17076	36.51	57.15	—	—	I5B.	25364	37.00	49.00	5.00	—	I5BB
13056	36.00	58.00	10.00	16.00	ESPE	—	36.51	57.20	12.70	—	I2BB	14714	37.00	50.00	10.00	—	I5BB
21662	36.00	58.00	12.00	—	I2B.	21679	36.51	57.51	11.51	—	I5BB	14714	37.00	50.00	10.00	—	I5BB
—	36.00	60.00	8.00	—	I2BB	21680	36.51	57.94	12.70	—	I2BA	21694	37.00	50.00	10.00	—	I2BB
—	36.00	60.00	9.50	—	I2BB	21681	36.51	58.74	9.53	—	I2BA	—	37.00	52.00	7.00	—	I2BB
—	36.00	60.00	10.00	—	I2BB	15149	36.51	60.00	12.00	—	I5BB	11967	37.00	52.00	7.00	—	I5BB
18506	36.00	61.30	13.00	—	I5BB	17959	36.51	60.33	6.35	—	I4BA	13537	37.00	52.00	8.00	—	I2BB
20089	36.00	62.00	7.00	—	I5BB	13826	36.51	60.33	9.53	—	I2BB	13537	37.00	52.00	8.00	—	I2BA
21663	36.00	62.00	7.00	—	I5BA	13876	36.51	60.33	9.53	—	I5BA	13537	37.00	52.00	8.00	—	I5BB
—	36.00	62.00	8.00	—	I2BB	21682	36.51	60.33	12.70	—	I5BB	21695	37.00	52.00	10.00	—	I5B.
21664	36.00	62.00	9.00	—	I5B.	15149	36.51	60.33	12.70	—	I5B.	16114	37.00	52.70	7.00	—	I5BB
—	36.00	68.00	10.00	—	I5BB	15149	36.51	60.33	12.70	—	I5C	25417	37.00	55.00	10.00	—	I5BB
21665	36.00	68.00	10.00	—	I5BB	18510	36.51	60.33	23.81	—	I7B.	—	37.00	55.00	10.00	—	I2BB
15455	36.00	68.26	12.70	—	I5BA	18506	36.51	61.12	13.48	—	I5BB	25414	37.00	56.00	7.00	—	I5BB
—	36.00	70.00	8.00	—	I2BB	18506	36.51	61.12	13.48	—	I5BB	21696	37.00	58.00	13.00	—	I5B.
—	36.00	72.00	8.00	—	I2BB	—	36.51	61.90	7.50	—	I5BA	21697	37.00	60.00	10.00	—	I5BA
21666	36.00	72.00	12.00	—	I5B.	12365	36.51	61.91	6.35	—	I5BA	21698	37.00	60.00	12.00	—	I5BB
—	36.00	83.00	12.00	—	I5BB	15451	36.51	61.91	7.14	—	I4BA	21699	37.00	62.00	8.00	—	I5B.
14349	36.00	83.00	12.00	—	I5BB	15451	36.51	61.91	7.14	—	I4C	21700	37.00	62.00	9.00	—	I5B.
21667	36.00	83.00	12.00	—	I5BA	21683	36.51	61.91	11.11	—	I5B.	21701	37.00	62.00	10.00	—	I5BB
14349	36.00	83.00	12.00	—	I2B.	15457	36.51	61.91	11.91	—	I5BB	21703	37.00	62.00	12.00	—	I5BB
14349	36.00	83.00	12.00	—	I5C	15428	36.51	61.91	11.91	—	I4C	21702	37.00	62.00	12.00	—	I5B.
—	36.50	50.50	7.00	—	I2BB	15457	36.51	61.91	11.91	—	I5C	21704	37.00	64.00	9.00	—	I5BB
16460	36.50	51.80	7.93	—	I5BB	18511	36.51	61.91	19.84	—	I1FB	25403	37.00	70.00	8.00	—	I2B.
—	36.50	52.30	8.00	—	I2BB	17501	36.51	63.50	9.53	—	F	12770	37.00	73.00	10.00	—	I5JM
17332	36.50	57.15	12.70	—	I5BB	21684	36.51	63.50	12.70	—	I5BB	14351	37.00	80.00	12.00	—	I5B.
13769	36.51	44.45	9.53	—	I5BA	17154	36.51	63.50	12.70	—	I5BA	16381	37.11	57.11	13.00	—	I7BB
21668	36.51	47.63	6.35	6.00	I2BB	17154	36.51	63.50	12.70	—	I5B.	15892	37.31	46.83	6.35	—	I4BB
21670	36.51	49.21	6.35	—	I5BB	18512	36.51	63.50	19.05	—	I1FB	15892	37.31	46.83	6.35	—	I4BA
18507	36.51	50.80	3.18	—	I4BA	17971	36.51	63.50	22.22	—	I9BB	15669	37.31	52.39	6.35	—	I13
17437	36.51	50.80	4.76	—	ESPE	17971	36.51	63.50	22.23	—	I7B.	15300	37.31	53.98	7.94	—	CORT
21671	36.51	50.80	6.99	—	I5BB	17971	36.51	63.50	22.23	—	I7C	21705	37.31	57.55	7.94	—	I5B.
21672	36.51	50.80	7.94	—	I5BA	17567	36.51	64.29	15.88	—	ESPE	21706	37.31	60.33	7.94	—	I5BA
12591	36.51	50.80	7.94	—	I2BA	21685	36.51	65.09	14.29	—	I5BB	15202	37.31	60.33	12.70	—	I5B.
12591	36.51	50.80	8.00	—	I2BB	17660	36.51	65.09	14.29	—	I5B.	21707	37.31	60.33	12.70	—	I5BB
21673	36.51	50.80	9.13	—	I5BB	21686	36.51	66.68	12.70	—	I5BB	11635	37.31	60.33	12.70	—	I2BB
14901	36.51	50.80	9.53	—	I5BB	18513	36.51	66.68	12.70	—	I5B.	15349	37.31	61.91	10.32	—	I13
14901	36.51	50.80	9.53	—	I5BA	17679	36.51	66.68	12.70	—	ESPE	15313	37.31	65.09	12.70	—	I13
18210	36.51	50.80	15.88	—	I1FB	—	36.51	68.22	12.70	—	I5BB	21709	37.31	66.68	12.70	—	I5BA





# Retentores

Perfis - Ver Última Página



INCOVE VEDAÇÕES LTDA.

Cod.	Di	De	Ha1	Ha2	Mod	Cod.	Di	De	Ha1	Ha2	Mod	Cod.	Di	De	Ha1	Ha2	Mod
19995	37.50	50.00	6.00	—	I2BB	12619	38.00	55.00	7.00	—	I5BB	13990	38.00	62.00	12.00	—	I5BA
—	37.50	81.00	12.70	—	F	—	38.00	55.00	8.00	—	I2BB	RB14	38.00	62.00	12.00	—	I2BA
—	37.70	55.00	8.00	—	I5BA	21724	38.00	55.00	8.00	—	I2BA	11618	38.00	63.00	13.00	—	I5BB
15117	37.70	57.15	6.35	—	I4BA	21725	38.00	55.00	9.00	—	I5B.	20219	38.00	64.80	19.00	—	I1FC
15117	37.70	57.15	6.35	—	I4BA	14348	38.00	55.00	10.00	—	I13	25416	38.00	65.00	8.00	—	I5BB
15169	37.70	57.15	7.94	—	I5BB	21726	38.00	55.00	10.00	—	I5B.	—	38.00	65.00	10.00	—	I2BB
15169	37.70	57.15	7.94	—	I5BA	14354	38.00	55.00	10.00	—	I5BB	13011	38.00	65.00	10.00	—	I5BB
15169	37.70	57.15	7.94	—	I5B.	14354	38.00	55.00	10.00	—	I5B	21742	38.00	65.00	10.00	—	I5B.
15117	37.70	57.35	6.35	—	I5C	14355	38.00	55.00	12.00	—	I5BB	—	38.00	65.00	12.00	—	I2BB
—	38.00	43.00	3.00	—	I4BA	14355	38.00	55.00	12.00	—	I5BA	21744	38.00	65.00	12.00	—	I5B.
—	38.00	47.00	7.00	—	I2BB	14355	38.00	55.00	12.00	—	I5B.	20373	38.00	65.05	6.35	—	I5BB
—	38.00	47.00	10.00	—	I5BA	14355	38.00	55.00	12.00	—	I5BB	15329	38.00	69.95	12.70	—	I5B.
—	38.00	47.60	6.50	—	I5BA	—	38.00	55.25	9.00	—	I2BB	—	38.00	70.00	8.00	—	I2BB
12157	38.00	48.00	4.00	—	I4BA	—	38.00	56.00	8.00	—	I2BB	—	38.00	72.00	7.00	—	I5BB
12604	38.00	48.00	8.00	—	I5BB	14356	38.00	56.00	8.00	—	I5BA	—	38.00	72.00	10.00	—	I2BB
13008	38.00	48.00	12.00	—	I5BA	13153	38.00	56.00	9.00	—	I55B	—	38.00	72.00	12.00	—	I2BB
—	38.00	50.00	6.00	—	I2BB	—	38.00	56.00	10.00	—	I2BB	20252	38.00	72.00	12.00	—	I5BB
21710	38.00	50.00	6.00	—	I5BB	14357	38.00	56.00	10.00	—	I5BB	21745	38.00	72.00	12.00	—	I5B.
—	38.00	50.00	7.00	—	I2BB	21727	38.00	56.00	10.00	—	I5B.	20252	38.00	72.00	12.00	—	I5BB
14352	38.00	50.00	7.00	—	I5BA	21728	38.00	56.00	10.00	—	I2BA	—	38.00	73.95	11.00	—	I2BA
14352	38.00	50.00	7.00	—	I5BB	21729	38.00	56.00	12.00	—	I5BA	—	38.00	74.00	8.00	—	I2BB
14352	38.00	50.00	7.00	—	I5BB	21730	38.00	57.00	7.00	—	I5BB	—	38.00	74.00	10.00	—	I2BB
14352	38.00	50.00	7.00	—	I5BA	21730	38.00	57.00	7.00	—	I5BA	14361	38.00	74.00	10.00	—	I2BA
21711	38.00	50.00	7.00	—	I2BA	13152	38.00	57.00	9.00	—	ESPE	14361	38.00	74.00	10.00	—	I2BB
—	38.00	50.00	8.00	—	I2BB	11801	38.00	57.00	9.60	—	I5C	—	38.00	74.00	11.00	—	I2BA
21712	38.00	50.00	8.00	—	I5BB	22569	38.00	57.00	12.70	—	I5BB	14361	38.00	74.00	11.00	—	I2BA
—	38.00	50.00	10.00	—	I2BB	—	38.00	57.15	8.00	—	I5BA	21747	38.00	74.00	11.00	—	I2BA
—	38.00	50.35	11.00	—	I2B.	21731	38.00	58.00	8.00	—	I2BB	16024	38.00	74.20	11.00	—	I2BA
16251	38.00	50.50	14.00	—	ESPE	—	38.00	58.00	8.50	—	I2BB	16024	38.00	74.20	11.00	—	I2BA
18665	38.00	50.80	8.00	—	I2BA	—	38.00	58.00	11.00	—	I2BA	14362	38.00	75.00	8.00	—	I5BA
18665	38.00	50.80	8.00	—	I2BA	—	38.00	58.00	11.00	—	I2BB	—	38.00	78.00	8.00	—	I2BB
12535	38.00	51.00	6.50	—	I4BB	21734	38.00	58.00	11.00	—	I5BB	11197	38.00	78.00	8.00	10.00	I550
11644	38.00	51.00	7.00	—	I5BB	21732	38.00	58.00	11.00	—	I5BA	11196	38.00	78.00	80.00	9.50	I7BB
—	38.00	52.00	7.00	—	I5BA	21733	38.00	58.00	11.00	—	I2BA	—	38.00	80.00	8.00	—	I2BB
—	38.00	52.00	7.00	—	I2BB	21735	38.00	58.00	12.00	—	I5BB	11396	38.00	80.00	8.00	—	I5BA
14353	38.00	52.00	7.00	—	I5BB	14358	38.00	58.00	12.00	—	I5BA	21748	38.00	80.00	12.00	—	I5BB
14353	38.00	52.00	7.00	—	I5BA	13828	38.00	58.30	8.50	—	I55B	12606	38.00	80.00	12.00	—	I5BA
14353	38.00	52.00	7.00	—	I5B.	—	38.00	58.50	7.00	—	I5BB	21749	38.00	85.00	10.00	—	I5BA
14353	38.00	52.00	7.00	—	I2BA	21736	38.00	58.50	7.00	—	I5BB	—	38.00	90.00	8.00	—	I2BB
21713	38.00	52.00	8.00	—	I5BB	—	38.00	59.00	8.00	—	I2BB	—	38.10	47.60	7.00	—	I5BA
—	38.00	52.00	8.00	—	I2BB	—	38.00	59.00	9.00	—	I2BB	21750	38.10	47.61	6.35	—	I5BB
21713	38.00	52.00	8.00	—	I5BB	21737	38.00	59.00	10.00	—	I5BB	—	38.10	47.62	4.76	—	I4BA
21715	38.00	52.00	8.00	—	I2BB	14359	38.00	59.00	10.00	—	I5BA	15666	38.10	47.63	3.97	—	I4B.
13828	38.00	52.00	8.50	2.50	ESPE	21738	38.00	59.00	12.00	—	I2BB	13336	38.10	47.63	4.76	—	I5BA
13153	38.00	52.00	9.00	—	ESPE	—	38.00	60.00	7.00	—	I2BB	13336	38.10	47.63	4.76	—	I5BA
—	38.00	52.00	10.00	—	I5BA	—	38.00	60.00	8.00	—	I2BB	21751	38.10	47.63	5.16	—	I5BA
17178	38.00	52.00	10.00	—	I5BB	14360	38.00	60.00	8.00	—	I5BA	—	38.10	47.63	6.35	—	I5BA
17178	38.00	52.00	10.00	—	I2BB	—	38.00	60.00	10.00	—	I5BB	14696	38.10	47.63	6.35	—	I5BA
17178	38.00	52.00	10.00	—	I5BB	11257	38.00	60.00	10.00	—	I5BB	14696	38.10	47.63	6.35	—	I5BB
21717	38.00	52.00	10.00	—	I5BA	11257	38.00	60.00	10.00	—	I5B.	14696	38.10	47.63	6.35	—	I5BA
21718	38.00	52.00	10.00	—	I2BB	13099	38.00	60.00	12.00	—	I13	15621	38.10	49.21	6.35	—	I4BA
21719	38.00	52.00	11.00	—	I2BA	15766	38.00	60.00	12.00	—	I5B.	13332	38.10	49.21	6.35	—	I5BB
—	38.00	52.25	6.20	—	I4BA	12687	38.00	60.00	13.00	—	I5B.	—	38.10	50.30	11.90	—	I5BA
—	38.00	52.25	7.00	—	I5BB	—	38.00	62.00	7.00	—	I2BB	—	38.10	50.36	9.90	—	I5BB
21720	38.00	53.00	8.00	—	I2BB	12625	38.00	62.00	7.00	—	I5BA	17649	38.10	50.40	6.35	—	I4BA
13151	38.00	53.00	8.50	—	I2BB	12625	38.00	62.00	7.00	—	I5BB	17649	38.10	50.40	6.35	—	I4BA
13151	38.00	53.00	9.00	—	I2BB	21739	38.00	62.00	7.00	—	I5BA	13399	38.10	50.40	9.52	—	I4BA
—	38.00	54.00	7.00	—	I2BB	11143	38.00	62.00	9.00	—	I7BB	—	38.10	50.40	10.31	—	I4BA
21721	38.00	54.00	10.00	—	I5BB	21740	38.00	62.00	9.00	—	I5B.	13818	38.10	50.40	10.90	—	I2BA
—	38.00	54.00	10.00	—	I5BA	11143	38.00	62.00	9.00	10.50	I7BB	13818	38.10	50.40	10.90	—	I2BB
—	38.00	54.00	10.00	—	I2BB	—	38.00	62.00	10.00	—	I2BB	21752	38.10	50.40	11.11	—	I5B.
15759	38.00	54.00	10.00	—	I5BB	16218	38.00	62.00	10.00	—	I13	21753	38.10	50.40	11.11	—	I2BA
21722	38.00	54.00	10.00	—	I5BA	11291	38.00	62.00	10.00	—	I5BB	17030	38.10	50.40	11.12	—	I5B.
25432	38.00	54.50	10.00	—	I5BB	21741	38.00	62.00	10.00	—	I5BA	17030	38.10	50.40	11.12	—	I5C
—	38.00	55.00	7.00	—	I2BB	11791	38.00	62.00	10.00	—	I2B.	—	38.10	50.52	6.35	—	I4BA
12619	38.00	55.00	7.00	—	I5BB	11291	38.00	62.00	10.00	—	I5BB	—	38.10	50.52	6.35	—	I2BA
21723	38.00	55.00	7.00	—	I5BA	—	38.00	62.00	12.00	—	I5BA	18230	38.10	50.80	3.18	—	F





# Retenfores

Perfis - Ver Última Página



INCOVE VEDAÇÕES LTDA.

Cod.	Di	De	Ha1	Ha2	Mod	Cod.	Di	De	Ha1	Ha2	Mod	Cod.	Di	De	Ha1	Ha2	Mod
15094	38.10	50.80	5.50	—	I4BA	18520	38.10	57.15	6.35	—	I4B.	18521	38.10	61.91	6.35	—	I4BA
15094	38.10	50.80	5.50	—	I4BA	21766	38.10	57.15	6.35	—	I5BA	16981	38.10	61.91	7.94	—	I5B.
13269	38.10	50.80	5.56	—	I5BB	11310	38.10	57.15	6.35	—	I5B.	15439	38.10	61.91	9.53	—	I13
21754	38.10	50.80	5.56	—	I5BA	13471	38.10	57.15	7.14	—	I5BA	15878	38.10	61.91	11.11	—	CORT
13269	38.10	50.80	5.56	—	I5BB	21767	38.10	57.15	7.94	—	I5BA	15223	38.10	61.91	11.91	—	I5C
—	38.10	50.80	6.35	—	I2BA	—	38.10	57.15	8.00	—	I5BB	15223	38.10	61.91	11.91	—	I5BB
20417	38.10	50.80	6.35	—	I2BB	21768	38.10	57.15	9.53	—	I5BB	15223	38.10	61.91	11.91	—	I5BA
11264	38.10	50.80	6.35	—	I5BA	21769	38.10	57.15	9.53	—	I5BA	15694	38.10	61.91	14.29	—	I1FA
13268	38.10	50.80	7.94	—	I5BB	21769	38.10	57.15	9.53	—	I5B.	18114	38.10	61.91	28.58	—	ESPE
21755	38.10	50.80	7.94	—	I5BA	21770	38.10	57.15	9.53	—	I2BA	15694	38.10	62.08	14.00	—	I1FA
13268	38.10	50.80	7.94	—	I5BB	15385	38.10	57.15	11.11	—	I7B.	15349	38.10	62.31	10.32	—	I13
21756	38.10	50.80	9.35	—	I5BA	21771	38.10	57.15	11.11	—	I5B.	13021	38.10	62.71	11.11	—	I5BB
18517	38.10	50.80	9.52	—	I5BA	21772	38.10	57.15	11.11	—	I2B.	13021	38.10	62.71	11.11	—	I2BB
18517	38.10	50.80	11.11	—	I5BB	21773	38.10	57.15	11.91	—	I5BB	13021	38.10	62.71	11.11	—	I2BB
21757	38.10	50.80	11.11	—	I5B.	21775	38.10	57.15	12.70	—	I5B.	17400	38.10	62.71	12.70	—	I13
18516	38.10	50.80	11.91	—	I13	—	38.10	57.15	12.70	—	I5BA	15014	38.10	63.50	6.35	—	I4BA
18517	38.10	50.80	12.70	—	I5C	18519	38.10	57.15	12.70	—	I8O	15014	38.10	63.50	6.35	—	I4C
18515	38.10	50.80	13.49	—	I1FB	15708	38.10	57.15	12.70	—	I13	21784	38.10	63.50	7.94	—	I5B.
17448	38.10	50.80	19.05	—	F	17332	38.10	57.15	12.70	—	I5BA	11625	38.10	63.50	7.94	—	I2BA
11935	38.10	51.10	11.10	—	I5B.	17332	38.10	57.15	12.70	—	I5C	15831	38.10	63.50	7.94	—	I4BA
11935	38.10	51.10	11.11	—	I5B.	17956	38.10	57.15	15.88	—	ESPE	15174	38.10	63.50	9.50	—	I5BA
—	38.10	51.20	5.40	—	I2BA	17296	38.10	57.15	19.05	—	I1BF	15174	38.10	63.50	9.52	—	I5BB
—	38.10	52.37	11.11	—	I5BB	17296	38.10	57.15	19.05	—	I1FC	15174	38.10	63.50	9.53	—	I5BB
13017	38.10	52.39	6.35	—	I4BA	17332	38.10	57.25	12.70	—	I5BA	11362	38.10	63.50	9.53	—	I2BB
15669	38.10	52.39	6.35	—	I13	17155	38.10	57.94	12.70	—	I2BB	15174	38.10	63.50	9.53	—	I5BB
14055	38.10	52.39	6.35	—	I5BB	13816	38.10	58.50	7.00	—	I5BB	11012	38.10	63.50	10.00	—	I7JM
21758	38.10	52.39	7.94	—	I5BB	13816	38.10	58.50	7.00	—	I5BB	21785	38.10	63.50	11.11	—	I5BA
21759	38.10	52.39	7.94	—	I5BA	17416	38.10	58.74	4.76	—	F	21786	38.10	63.50	11.11	—	I2BA
12780	38.10	52.39	9.53	—	I5B.	15502	38.10	58.74	4.76	—	I13	15013	38.10	63.50	12.70	—	I5BB
21760	38.10	52.39	9.53	—	I2BA	21776	38.10	58.74	6.99	—	I5BB	12269	38.10	63.50	12.70	—	I2BB
16699	38.10	52.39	9.60	—	I2BA	16439	38.10	58.74	9.53	—	I5BB	15013	38.10	63.50	12.70	—	I5BB
17178	38.10	52.39	11.11	—	I5BA	16439	38.10	58.74	9.53	—	I5BA	15013	38.10	63.50	12.70	—	I5BB
17178	38.10	52.39	11.11	—	I5B.	—	38.10	60.00	12.70	—	I5BB	15013	38.10	63.50	12.70	—	I5B.
16541	38.10	52.39	11.11	—	I5B.	—	38.10	60.30	12.70	—	I2BA	21787	38.10	63.50	12.70	—	I2BB
17178	38.10	52.39	11.11	—	I5C	—	38.10	60.30	12.70	—	I5BA	13308	38.10	63.50	12.70	—	I2B.
—	38.10	52.40	7.14	—	I5BB	—	38.10	60.30	12.70	—	I2BA	15013	38.10	63.50	12.70	—	I5B.
—	38.10	53.97	11.11	—	I5BB	13819	38.10	60.30	12.70	17.70	I550	14041	38.10	63.50	12.70	14.29	I21B
21761	38.10	53.98	4.76	—	I5BB	—	38.10	60.30	19.05	—	I2BA	15942	38.10	63.50	15.88	—	I813
21762	38.10	53.98	6.35	—	I5BB	17729	38.10	60.33	6.35	—	I4C	21788	38.10	63.50	15.88	—	I2B.
14684	38.10	53.98	6.35	—	I5BB	13048	38.10	60.33	7.94	—	I5BA	17206	38.10	63.50	15.88	—	I12C
13638	38.10	53.98	7.94	—	I5BB	21777	38.10	60.33	9.53	—	I5BB	15327	38.10	63.50	16.67	—	I3C
17521	38.10	53.98	9.53	—	I13	16388	38.10	60.33	9.53	—	I5BA	21789	38.10	63.50	17.46	—	I2B.
21708	38.10	53.98	10.00	—	I2BA	14438	38.10	60.33	9.53	—	I2BB	13309	38.10	63.50	17.46	—	I2B.
15759	38.10	53.98	11.11	—	I5C	14438	38.10	60.33	9.53	—	I2B.	18357	38.10	63.50	19.05	—	I9B.
15759	38.10	53.98	11.11	—	I5BB	13819	38.10	60.33	12.70	—	I2BA	21790	38.10	63.50	19.05	—	I2B.
21763	38.10	53.98	11.11	—	I5BB	13819	38.10	60.33	12.70	—	I2BA	17316	38.10	63.50	19.05	—	I1BF
15759	38.10	53.98	11.11	—	I5B.	15131	38.10	60.33	12.70	—	I5B.	17316	38.10	63.50	19.05	—	I1FC
17493	38.10	53.98	11.11	—	I2BA	13819	38.10	60.33	12.70	—	I2BB	17568	38.10	63.50	52.78	—	I2BA
15759	38.10	53.98	11.11	—	I5C	15131	38.10	60.33	12.70	—	I5B.	.....	38.10	63.55	7.90	—	I5BA
17090	38.10	53.98	14.29	—	I3B.	15131	38.10	60.33	12.70	—	I5BB	.....	38.10	63.55	9.52	—	I5BB
18518	38.10	53.98	14.29	—	I9BC	21778	38.10	60.33	12.70	—	I5B.	.....	38.10	63.55	12.70	—	I5BA
14864	38.10	54.30	7.00	—	I4BA	13819	38.10	60.33	12.70	—	I2BB	.....	38.10	63.55	16.66	—	I2BA
14864	38.10	54.30	7.00	—	I4BB	21780	38.10	60.33	12.70	—	I2BA	15312	38.10	65.09	12.70	—	I13
—	38.10	55.55	11.11	—	I5BB	15131	38.10	60.33	12.70	17.70	I5BB	17556	38.10	65.09	12.70	—	I5BA
21764	38.10	55.56	6.35	—	I5BB	14017	38.10	60.33	15.08	—	I21B	17556	38.10	65.09	12.70	—	I5B.
18923	38.10	55.56	6.35	—	I5BA	21782	38.10	60.33	15.88	—	I2B.	17556	38.10	65.09	12.70	—	I5C
21764	38.10	55.56	6.35	—	I5BA	19920	38.10	60.33	15.88	—	I1BF	13074	38.10	66.68	4.76	—	ESPE
21765	38.10	55.56	9.13	—	I5BA	17668	38.10	60.33	17.46	—	I12C	15622	38.10	66.68	6.35	—	I4BB
15090	38.10	55.56	11.11	—	I5B.	15739	38.10	60.33	19.05	—	I1BF	15622	38.10	66.68	6.35	—	I4BA
15090	38.10	55.56	11.11	—	I5C	15052	38.10	60.33	19.05	—	I1FB	15622	38.10	66.68	6.35	—	I4C
17454	38.10	55.56	12.70	—	I80	15052	38.10	60.33	19.05	—	I1FC	17580	38.10	66.68	10.00	—	I5C
13656	38.10	55.56	12.70	—	I5BA	17672	38.10	60.33	19.05	—	I12B	18995	38.10	66.68	12.70	—	I2BA
14906	38.10	55.56	12.70	—	I55	15739	38.10	60.33	19.05	—	I1FC	21791	38.10	66.68	14.29	—	I2BA
17536	38.10	55.56	14.29	—	F	17734	38.10	60.33	26.19	—	I1FB	15876	38.10	66.68	14.29	—	I2B.
20204	38.10	57.10	9.50	—	I2BA	17233	38.10	61.12	12.70	—	I5B.	21792	38.10	66.68	15.88	—	I2BA
12366	38.10	57.15	4.76	—	I4BB	.....	38.10	61.16	13.49	—	I5BB	15184	38.10	67.47	9.53	—	I5BA
12366	38.10	57.15	4.76	—	I4BB	21783	38.10	61.52	12.70	—	I5B.	.....	38.10	68.22	12.70	—	I5BB



# Retentores

Perfis - Ver Última Página



INCOVE VEDAÇÕES LTDA.

Cod.	Di	De	Ha1	Ha2	Mod	Cod.	Di	De	Ha1	Ha2	Mod	Cod.	Di	De	Ha1	Ha2	Mod
18522	38.10	68.26	12.70	—	15BB	13277	38.89	60.33	9.53	—	15BB	.....	39.69	57.83	12.00	—	12BB
18522	38.10	68.26	12.70	—	15B.	21803	38.89	60.33	12.70	—	15BB	.....	39.69	58.98	9.75	—	12BB
21793	38.10	69.06	11.91	—	15BB	18342	38.89	60.33	12.70	—	15BA	.....	39.69	58.98	9.75	—	12BB
17066	38.10	69.06	11.91	—	15C	17707	38.89	60.33	17.86	—	112	21812	39.69	59.53	11.11	—	15BA
13704	38.10	69.06	12.70	—	15B.	15744	38.89	61.91	6.35	—	F	.....	39.69	60.30	9.50	—	15BB
17398	38.10	69.85	7.94	—	ESPE	21804	38.89	63.50	12.70	—	15BB	18339	39.69	60.33	6.35	—	14BA
13033	38.10	69.85	9.53	—	15BB	17726	38.89	63.50	12.70	—	15BA	15336	39.69	60.33	7.94	—	F
13033	38.10	69.85	9.53	—	15BA	15622	38.89	66.68	6.35	—	14C	12670	39.69	60.33	9.53	—	15BA
13033	38.10	69.85	9.53	—	15B.	15622	38.89	66.68	6.35	—	14B.	12309	39.69	60.33	12.70	—	17BB
.....	38.10	69.85	11.90	—	15BA	17343	38.89	66.68	12.70	—	15BA	17312	39.69	60.33	12.70	—	15BA
15683	38.10	69.85	12.70	—	15BA	15368	38.89	68.26	11.91	—	113	17312	39.69	60.33	12.70	—	15B.
15683	38.10	69.85	12.70	—	15C	21805	38.89	69.85	12.70	—	15BB	17312	39.69	60.33	12.70	—	15B.
18001	38.10	69.85	19.05	—	11FC	17176	38.89	72.23	20.64	—	11FB	21813	39.69	60.33	15.88	—	12BA
15581	38.10	70.25	12.70	—	15C	21806	38.98	60.33	12.70	—	12BB	18528	39.69	60.33	15.88	—	12B.
16926	38.10	72.60	11.50	—	15BB	13087	39.00	43.00	16.00	—	ESPE	15259	39.69	61.12	12.70	—	15BB
14676	38.10	72.60	11.50	—	15BB	25467	39.00	50.00	6.00	—	15BB	21814	39.69	61.12	12.70	—	15B.
14676	38.10	72.63	11.11	—	15BB	.....	39.00	50.40	8.50	—	12BA	15259	39.69	61.12	12.70	—	15C
21794	38.10	73.03	11.50	—	12BA	13568	39.00	50.50	8.00	—	14BA	18532	39.69	61.12	13.10	—	13BC
18523	38.10	73.03	11.51	—	15BB	21807	39.00	52.00	6.50	—	15BA	21815	39.69	61.52	12.70	—	15B.
18523	38.10	73.03	11.51	—	15BB	20220	39.00	52.00	57.50	8.50	13BB	18529	39.69	61.90	6.40	—	14BA
21795	38.10	73.03	11.51	—	15BB	13714	39.00	54.00	8.00	—	15BA	17533	39.69	61.91	4.76	—	113
18523	38.10	73.03	11.51	—	15BB	13087	39.00	54.50	16.00	—	ESPE	18529	39.69	61.91	4.76	—	14BB
21796	38.10	73.20	12.70	—	15B.	16156	39.00	55.00	7.00	—	12BB	18529	39.69	61.91	6.40	—	14BA
15755	38.10	73.82	12.30	—	ESPE	16846	39.00	56.50	11.00	—	15BB	15644	39.69	61.91	10.00	—	15C
14839	38.10	74.61	11.11	—	13B.	16452	39.00	58.00	5.80	—	15BB	15644	39.69	61.91	11.91	—	12BB
18092	38.10	74.61	15.88	—	15BA	20221	39.00	59.50	9.50	—	12BB	15644	39.69	61.91	11.91	—	15BB
.....	38.10	76.12	12.70	—	15BB	.....	39.00	62.00	9.50	—	15BB	21816	39.69	61.91	11.91	—	12B.
17552	38.10	76.20	9.53	—	1813	21808	39.00	62.00	12.00	—	15B.	15644	39.69	61.91	11.91	—	15B.
21797	38.10	76.20	12.70	—	15BB	20099	39.00	64.00	13.00	—	15C	15089	39.69	61.91	12.70	—	15BB
17893	38.10	76.20	12.70	—	15B.	.....	39.00	74.00	11.00	—	12BB	15089	39.69	61.91	12.70	—	ESPE
17534	38.10	76.20	23.02	—	ESPE	15858	39.29	68.26	6.35	—	ESPE	21817	39.69	61.91	12.70	—	12BB
.....	38.10	77.75	12.70	—	12BA	.....	39.40	63.55	12.50	—	12BB	15527	39.69	61.91	12.70	—	155
21799	38.10	77.79	15.51	—	15BB	.....	39.40	63.55	12.70	—	12BB	12790	39.69	61.91	14.29	—	12BA
21798	38.10	77.79	15.51	—	15B.	12320	39.40	70.00	6.40	16.40	12BB	21818	39.69	61.91	14.29	—	12BA
13073	38.10	77.90	11.11	—	15BB	.....	39.40	80.10	6.40	16.20	12	17225	39.69	61.91	15.08	—	11BF
15995	38.10	79.38	12.70	—	F	15043	39.40	80.20	11.80	—	12BA	15427	39.69	61.91	19.84	—	11FB
.....	38.10	79.38	15.87	—	12BA	12317	39.40	80.40	6.40	16.40	12BB	15427	39.69	61.91	19.84	—	11FC
17761	38.10	79.38	15.88	—	112B	.....	39.42	57.10	8.00	—	15BB	.....	39.69	62.00	19.05	—	12BA
17761	38.10	79.38	15.88	—	112B	.....	39.42	63.55	12.70	—	15BB	18067	39.69	63.50	6.35	—	113
17423	38.10	80.00	7.94	—	CORT	.....	39.42	63.55	12.70	—	12BB	18530	39.69	63.50	6.35	—	14BA
18524	38.10	80.96	11.11	—	15BB	.....	39.42	74.50	11.90	—	12BB	21819	39.69	63.50	6.35	—	15B.
18524	38.10	80.96	11.11	—	15BA	16505	39.50	50.00	8.00	—	15BB	18530	39.69	63.50	6.35	—	14BA
21800	38.10	84.93	11.91	—	15BB	16562	39.50	50.10	10.00	—	15BA	18530	39.69	63.50	6.35	—	14C
18525	38.10	84.93	11.91	—	15BA	12907	39.50	54.50	3.00	16.00	ESPE	15885	39.69	63.50	9.53	—	15BA
21801	38.10	89.69	12.70	—	15BB	20175	39.60	69.85	7.00	—	15BB	15885	39.69	63.50	9.53	—	15B.
18526	38.10	89.69	12.70	—	15BA	.....	39.62	60.98	12.70	—	12BA	15885	39.69	63.50	9.53	—	15BA
18940	38.10	92.08	14.29	—	155	15473	39.69	44.45	6.35	—	F	15026	39.69	63.50	11.11	—	F
18078	38.10	98.43	3.18	—	F	13612	39.69	50.80	3.97	—	14B.	15026	39.69	63.50	11.11	—	ESPE
15355	38.10	123.00	36.51	—	155	18924	39.69	50.80	6.35	—	14B.	12271	39.69	63.50	12.70	—	12BB
15327	38.16	63.50	16.67	—	13C	21809	39.69	50.80	6.35	—	15BB	15888	39.69	63.50	12.70	—	15B.
.....	38.17	60.33	12.70	—	12BA	17389	39.69	52.39	6.35	—	F	15888	39.69	63.50	12.70	—	15C
22562	38.20	63.50	11.11	—	15BA	18527	39.69	52.39	6.35	—	14BA	12271	39.69	63.50	12.70	—	12BB
22562	38.20	63.50	11.11	—	15C	17089	39.69	53.58	6.35	—	15BB	15888	39.69	63.50	12.70	—	15B
11227	38.20	63.70	15.70	—	12BA	17089	39.69	53.58	6.35	—	15BA	15888	39.69	63.50	12.70	—	15BB
.....	38.50	46.05	14.50	—	ESPE	16205	39.69	53.97	7.94	—	15BB	15888	39.69	63.50	12.70	—	15C
12341	38.50	50.90	7.90	9.20	14BB	18240	39.69	55.56	7.94	—	15BB	17530	39.69	63.50	16.67	—	11BF
.....	38.50	58.00	8.50	—	12BB	18240	39.69	55.56	7.94	—	15BA	17972	39.69	63.50	19.05	—	112
12578	38.50	58.00	10.00	—	15BB	21810	39.69	55.56	9.13	—	15BA	15412	39.69	64.69	19.05	—	ESPE
12514	38.50	60.50	7.50	—	15BA	.....	39.69	56.36	7.94	—	14BB	15412	39.69	64.69	19.05	—	11F
.....	38.63	67.46	12.70	—	15BA	21811	39.69	56.36	7.94	—	15BA	15555	39.69	65.09	12.70	—	15BB
25451	38.80	47.20	5.90	—	15BB	12214	39.69	57.15	6.35	—	14BA	15714	39.69	65.09	12.70	—	113
21802	38.81	44.45	11.11	—	15BB	12214	39.69	57.15	6.35	—	14BA	15555	39.69	65.09	12.70	—	15B.
.....	38.81	66.62	6.35	—	14BA	17957	39.69	57.15	9.53	—	15BB	15555	39.69	65.09	12.70	—	15B.
.....	38.86	60.29	12.70	—	12BA	17957	39.69	57.15	9.53	—	15BA	15714	39.69	65.09	12.70	—	14BA
11315	38.89	50.80	6.35	—	14BA	13427	39.69	57.15	11.91	—	15BB	17426	39.69	65.88	12.70	—	ESPE
15669	38.89	52.39	6.35	—	113	13427	39.69	57.15	11.91	—	15BB	17426	39.69	65.88	12.70	—	18BB
15298	38.89	57.15	7.94	—	F	13427	39.69	57.15	11.91	—	15C	21820	39.69	66.68	11.30	—	12BA



# Retenfores

Perfis - Ver Última Página



INCOVE VEDAÇÕES LTDA.

Cod.	Di	De	Ha1	Ha2	Mod	Cod.	Di	De	Ha1	Ha2	Mod	Cod.	Di	De	Ha1	Ha2	Mod
14770	39.69	66.68	12.70	—	ESPE	11130	40.00	50.00	5.00	—	I2BB	21840	40.00	55.00	7.00	—	I5BA
14770	39.69	66.68	12.70	—	ESPE	11130	40.00	50.00	5.00	—	I2BB	11756	40.00	55.00	7.00	—	I2BA
15101	39.69	66.68	12.70	—	I5BB	20056	40.00	50.00	6.00	—	I5BB	14811	40.00	55.00	8.00	—	I2BB
15101	39.69	66.68	12.70	—	I5B.	.....	40.00	50.00	7.00	—	I2BB	14811	40.00	55.00	8.00	—	I2BB
13719	39.69	66.68	12.70	14.29	I2BA	11807	40.00	50.00	7.00	—	I5BB	—	40.00	55.00	8.00	—	I2BB
17776	39.69	66.68	15.88	—	I2B.	11807	40.00	50.00	7.00	—	I4BB	—	40.00	55.00	8.00	—	I2BB
14743	39.69	66.68	19.05	—	I1FC	25455	40.00	50.00	8.00	—	I5BB	—	40.00	55.00	8.00	—	I2BB
.....	39.69	68.22	9.52	—	I2BB	12871	40.00	50.00	8.00	—	I4BA	14811	40.00	55.00	8.00	—	I2BB
.....	39.69	68.25	12.70	—	I5BB	11985	40.00	50.00	9.00	—	I2BB	11956	40.00	55.00	8.00	—	I2BB
15021	39.69	68.26	9.53	—	I4BB	21831	40.00	50.00	9.00	—	I2BA	—	40.00	55.00	8.00	—	I2BB
13370	39.69	68.26	9.53	—	I5BB	11985	40.00	50.00	9.00	—	I5BB	—	40.00	55.00	8.00	—	I2BA
13370	39.69	68.26	9.53	—	I5B.	14363	40.00	50.00	10.00	—	I5BB	—	40.00	55.00	8.00	—	I2BB
15021	39.69	68.26	9.53	—	I4C	14363	40.00	50.00	10.00	—	I5B.	21844	40.00	55.00	9.00	—	I5BB
13370	39.69	68.26	9.53	—	I5C	14363	40.00	50.00	10.00	—	I5BB	21842	40.00	55.00	9.00	—	I5BA
17419	39.69	68.26	11.11	—	I2B.	13796	40.00	52.00	5.00	—	I4BA	21843	40.00	55.00	9.00	—	I5B.
21821	39.69	68.26	11.11	—	I5B.	.....	40.00	52.00	6.00	—	I2BB	16466	40.00	55.00	9.00	—	I2BB
14536	39.69	68.26	11.11	—	I1BF	11236	40.00	52.00	6.00	—	I5JM	23389	40.00	55.00	9.50	—	I2BA
15368	39.69	68.26	11.91	—	I13	20165	40.00	52.00	6.00	—	I5BB	23389	40.00	55.00	9.50	—	I2BA
15432	39.69	68.26	11.91	—	I4BB	—	40.00	52.00	6.00	—	I2BB	—	40.00	55.00	10.00	—	I2BB
21822	39.69	68.26	11.91	—	I5BB	14364	40.00	52.00	7.00	—	I5BB	13214	40.00	55.00	10.00	—	I5BB
21823	39.69	68.26	12.70	—	I5BB	14364	40.00	52.00	7.00	—	I5BB	14365	40.00	55.00	10.00	—	I5B.
17182	39.69	68.26	12.70	—	I5B.	13584	40.00	52.00	7.00	—	I2BB	14365	40.00	55.00	10.00	—	I5BB
.....	39.69	68.27	11.11	—	I2BB	.....	40.00	52.00	7.00	—	I2BB	14365	40.00	55.00	10.00	—	I5BB
17467	39.69	69.06	12.70	—	I5B.	.....	40.00	52.00	7.00	—	I2BA	21845	40.00	55.00	10.00	—	I5BA
18942	39.69	69.85	6.35	—	I80	14364	40.00	52.00	7.00	—	I5BA	14365	40.00	55.00	10.00	—	I5B.
21824	39.69	69.85	6.99	—	I2BB	14364	40.00	52.00	7.00	—	I5BA	21847	40.00	55.00	10.00	—	I2BB
20175	39.69	69.85	7.00	—	I5BB	14364	40.00	52.00	7.00	—	I5BB	12927	40.00	55.00	10.00	—	I2BA
16285	39.69	69.85	7.00	—	I2BB	21833	40.00	52.00	7.00	—	I5B.	—	40.00	55.00	10.00	—	I2BB
15329	39.69	69.85	12.70	—	I5B.	13584	40.00	52.00	7.00	—	I2BA	14365	40.00	55.00	10.00	—	I5BB
21825	39.69	69.85	12.70	—	I2B.	13584	40.00	52.00	7.00	—	I2B.	16969	40.00	55.00	12.00	—	I5BB
15329	39.69	69.85	12.70	—	I5C	14364	40.00	52.00	7.00	—	I5BB	16969	40.00	55.00	12.00	—	I5B.
21826	39.69	73.03	11.91	—	I5BB	14364	40.00	52.00	7.00	—	I5BB	—	40.00	56.00	7.00	—	I2BA
17777	39.69	73.03	11.91	—	I5B.	.....	40.00	52.00	7.50	—	I2BB	—	40.00	56.00	7.00	—	I2BB
14863	39.69	73.03	11.91	—	I55	12318	40.00	52.00	7.50	—	I2BB	12265	40.00	56.00	7.00	—	I2BA
18531	39.69	73.03	17.46	—	I1FB	12318	40.00	52.00	7.50	—	ESPE	12268	40.00	56.00	7.00	—	I5BB
18326	39.69	74.22	27.78	—	ESPE	13584	40.00	52.00	7.50	—	I2BB	12265	40.00	56.00	7.00	—	I2BA
17986	39.69	74.61	11.11	—	I13	12318	40.00	52.00	7.50	—	I2BA	12965	40.00	56.00	7.00	—	I5BA
21827	39.69	76.20	7.94	—	I5BB	13584	40.00	52.00	7.50	—	I2BB	12265	40.00	56.00	7.00	—	I2BA
15002	39.69	76.20	11.91	—	I5C	21834	40.00	52.00	8.00	—	I5BB	14367	40.00	56.00	8.00	—	I5BB
21828	39.69	76.20	12.70	—	I5BB	11629	40.00	52.00	8.00	—	I5BA	14367	40.00	56.00	8.00	—	I5BB
18916	39.69	76.20	12.70	—	I5B.	13583	40.00	52.00	8.00	—	I2BB	14367	40.00	56.00	8.00	—	I5BB
17796	39.69	76.20	15.88	—	ESPE	—	40.00	52.00	8.00	—	I2BB	14367	40.00	56.00	8.00	—	I5BB
17310	39.69	76.20	26.19	—	CORT	13583	40.00	52.00	8.00	—	I2BB	14367	40.00	56.00	8.00	—	I5BA
15730	39.69	76.60	11.11	—	I13	13150	40.00	52.00	9.00	—	ESPE	13235	40.00	56.00	8.00	—	I2BA
14863	39.69	76.60	11.91	—	I55	.....	40.00	52.00	9.00	—	I2BB	.....	40.00	56.00	8.50	—	I4BB
17658	39.69	79.38	10.32	—	ESPE	12220	40.00	52.00	9.00	—	I2BB	13217	40.00	56.00	8.50	—	I4BB
15043	39.69	80.17	15.88	—	ESPE	13150	40.00	52.00	9.00	—	ESPE	20513	40.00	56.00	9.00	—	I2BA
21830	39.69	90.09	9.53	—	I2BA	21835	40.00	52.00	9.00	—	I5BB	21848	40.00	56.00	9.00	—	I5BA
18462	39.69	92.08	25.40	—	ESPE	12220	40.00	52.00	9.00	—	I2BB	.....	40.00	56.00	10.00	—	I5BA
15278	39.69	114.70	14.68	—	I55	12220	40.00	52.00	9.00	—	I2BB	14369	40.00	56.00	10.00	—	I2BA
15259	39.70	61.20	12.70	—	I5B.	12220	40.00	52.00	9.00	—	I2BB	13236	40.00	56.00	10.00	—	I2BA
.....	39.70	62.00	11.00	—	I2BB	.....	40.00	52.00	10.00	—	I2BB	14368	40.00	56.00	10.00	—	I5BB
16717	39.70	63.50	7.90	—	I2BA	16459	40.00	52.00	10.00	—	I5BB	14368	40.00	56.00	10.00	—	I5BA
16591	39.70	63.50	12.70	—	I5B.	21837	40.00	52.00	12.00	—	I5BA	14368	40.00	56.00	10.00	—	I5B.
16614	39.70	66.70	12.70	—	I5B.	.....	40.00	52.35	8.50	3.00	ESPE	16476	40.00	56.00	10.00	—	I2BB
11946	39.70	69.85	12.70	—	I5JM	11265	40.00	52.50	6.00	—	I2BB	13236	40.00	56.00	10.00	—	I2BA
16396	39.96	50.80	11.11	—	I5BB	11538	40.00	52.50	7.00	—	I5BB	14368	40.00	56.00	10.00	—	I5BA
12158	40.00	47.00	4.00	—	I4BB	12754	40.00	53.00	7.00	—	I5BB	16476	40.00	56.00	10.00	—	I2BB
12158	40.00	47.00	4.00	—	I4BA	12754	40.00	53.00	7.00	—	I5BA	.....	40.00	56.00	12.00	—	I5BB
12908	40.00	48.00	4.00	—	I4BA	20106	40.00	53.00	8.00	10.70	I2BB	14370	40.00	56.00	12.00	—	I5BB
15360	40.00	48.00	4.00	—	I5BB	.....	40.00	54.00	5.00	—	I2BA	21851	40.00	56.00	12.00	—	I5BB
20055	40.00	48.00	8.00	—	I5BB	21838	40.00	54.00	6.00	—	I5BB	21850	40.00	56.00	12.00	—	I2BA
11037	40.00	48.00	11.00	—	I5BB	.....	40.00	54.00	7.00	—	I2BB	21852	40.00	57.00	4.50	—	I5BB
—	40.00	50.00	4.00	—	I4BB	21839	40.00	54.00	10.00	—	I2BB	12214	40.00	57.00	6.00	—	I4BA
12159	40.00	50.00	4.00	—	I4BA	11756	40.00	55.00	7.00	—	I2BA	14371	40.00	57.00	6.00	—	I5BA
12159	40.00	50.00	4.00	—	I4BA	12168	40.00	55.00	7.00	—	I5BB	21853	40.00	57.00	12.00	—	I5BB
12159	40.00	50.00	4.00	—	I4BA	12168	40.00	55.00	7.00	—	I5BB	16491	40.00	57.15	9.50	—	I5BB



# Retentores

Perfis - Ver Última Página



INCOVE VEDAÇÕES LTDA.

Cod.	Di	De	Ha1	Ha2	Mod	Cod.	Di	De	Ha1	Ha2	Mod	Cod.	Di	De	Ha1	Ha2	Mod
11081	40.00	57.50	9.50	—	14JM	.....	40.00	62.00	12.00	—	15BA	14385	40.00	72.00	12.00	—	15BA
25362	40.00	58.00	4.50	9.30	15JM	.....	40.00	62.00	12.00	—	12BB	.....	40.00	74.00	8.00	—	12BB
21854	40.00	58.00	6.00	—	15BB	.....	40.00	62.00	12.00	—	12B.	.....	40.00	75.00	8.00	—	12BB
.....	40.00	58.00	7.00	—	12BB	21866	40.00	62.00	12.00	—	15BB	.....	40.00	75.00	12.00	—	12BB
21855	40.00	58.00	8.00	—	12BB	21869	40.00	62.00	12.00	—	15B.	.....	40.00	80.00	7.00	—	12BB
21855	40.00	58.00	8.00	—	12BB	21870	40.00	62.00	12.00	—	12BA	.....	40.00	80.00	10.00	—	12BB
21855	40.00	58.00	8.00	—	12BB	.....	40.00	62.00	13.00	—	15BB	14386	40.00	80.00	10.00	—	15BB
21857	40.00	58.00	9.00	—	12BA	.....	40.00	62.00	13.00	—	12BB	21886	40.00	80.00	10.00	—	15BB
21856	40.00	58.00	9.00	—	15BB	16053	40.00	62.00	14.00	—	15BB	.....	40.00	80.00	12.00	—	15BB
11194	40.00	58.00	9.00	—	15B.	11423	40.00	62.00	15.00	—	15BB	.....	40.00	80.00	12.00	—	12BB
12712	40.00	58.00	10.00	—	12BB	11408	40.00	63.00	9.00	—	15BB	12367	40.00	80.00	13.00	—	15BA
12712	40.00	58.00	10.00	—	12BB	21871	40.00	64.00	7.50	—	15BB	12367	40.00	80.00	13.00	—	15B.
14372	40.00	58.00	10.00	—	15BB	22460	40.00	64.00	8.00	—	15BB	21887	40.00	80.00	13.00	—	12B.
14372	40.00	58.00	10.00	—	15BA	21872	40.00	64.00	12.00	—	15BB	12367	40.00	80.00	13.00	—	15BA
21858	40.00	58.00	10.00	—	15B.	25361	40.00	65.00	7.00	—	15BB	21888	40.00	80.00	18.00	—	15BA
14372	40.00	58.00	10.00	—	15BB	.....	40.00	65.00	8.00	—	12BB	16760	40.00	80.20	10.00	—	12BA
.....	40.00	58.00	12.00	—	15BB	14380	40.00	65.00	10.00	—	15BB	.....	40.00	82.90	10.00	—	12BB
13852	40.00	58.00	12.00	—	15BB	14380	40.00	65.00	10.00	—	15BA	.....	40.00	84.00	12.00	—	15BB
20123	40.00	58.00	12.00	—	17BB	14380	40.00	65.00	10.00	—	15B.	.....	40.00	85.00	8.00	—	12BB
14374	40.00	59.00	6.00	—	14BA	13064	40.00	65.00	10.00	—	12BB	21889	40.00	85.00	8.00	—	15BB
14375	40.00	60.00	7.00	—	15BB	14380	40.00	65.00	10.00	—	15BB	.....	40.00	85.00	10.00	—	12BB
.....	40.00	60.00	8.00	—	12BB	.....	40.00	65.00	12.00	—	12BB	.....	40.00	90.00	8.00	—	12BB
14375	40.00	60.00	8.00	—	15BB	13326	40.00	65.00	12.00	—	12BA	16852	40.00	90.00	8.00	—	15BB
14376	40.00	60.00	10.00	—	15BB	13326	40.00	65.00	12.00	—	12B.	.....	40.00	90.00	10.00	—	15B.
14376	40.00	60.00	10.00	—	15B.	21874	40.00	65.00	12.00	—	15B.	20365	40.00	90.00	10.00	—	15BB
.....	40.00	60.00	10.00	—	12BB	13326	40.00	65.00	12.00	—	12B.	21890	40.00	90.00	10.00	—	15BB
14376	40.00	60.00	10.00	—	15BB	11509	40.00	65.00	12.00	—	12B.	21892	40.00	90.00	10.00	—	15B.
14376	40.00	60.00	10.00	—	15BB	21875	40.00	65.00	14.00	—	12BB	.....	40.00	90.00	12.00	—	12BB
14377	40.00	60.00	10.00	—	180J	17981	40.00	65.00	15.00	—	155B	RB06	40.00	90.00	12.00	—	15B.
14376	40.00	60.00	10.00	—	15BA	13637	40.00	65.50	13.00	—	12BA	.....	40.00	90.15	20.00	—	ESPE
14376	40.00	60.00	10.00	—	15BB	11645	40.00	67.00	12.00	—	15BB	13227	40.10	52.00	8.00	—	1550
11203	40.00	60.00	10.00	—	12BA	21876	40.00	68.00	7.00	—	15BA	13227	40.10	52.00	8.50	—	1550
21860	40.00	60.00	10.00	—	12B.	13845	40.00	68.00	8.00	—	15BA	.....	40.10	61.16	12.70	—	12B
14378	40.00	60.00	12.00	—	15BB	RB37	40.00	68.00	10.00	—	15BB	.....	40.10	61.16	13.49	—	15B.
14378	40.00	60.00	12.00	—	15BB	11228	40.00	68.00	12.00	—	15BB	.....	40.48	53.97	7.93	—	15BA
14378	40.00	60.00	12.00	—	15BB	11228	40.00	68.00	12.00	—	15BB	21893	40.48	53.98	7.94	—	15BA
21861	40.00	60.00	12.00	—	15BA	11228	40.00	68.00	12.00	—	15B.	21894	40.48	61.91	11.11	—	15BB
14378	40.00	60.00	12.00	—	15B.	11228	40.00	68.00	12.00	—	15BA	15659	40.48	61.91	11.91	—	15B.
21862	40.00	60.00	12.00	—	12BB	.....	40.00	70.00	8.00	—	12BB	15699	40.48	61.91	13.49	—	CORT
11513	40.00	60.00	12.00	—	12BA	14383	40.00	70.00	10.00	—	15BB	.....	40.48	70.05	12.70	—	15BA
16496	40.00	61.26	13.00	—	15B.	14383	40.00	70.00	10.00	—	15BA	21895	40.50	54.00	7.00	—	12BA
.....	40.00	62.00	7.00	—	15BB	14383	40.00	70.00	10.00	—	15BB	12278	40.50	54.00	7.20	—	12BA
11534	40.00	62.00	7.00	—	15BA	14350	40.00	70.00	12.00	—	15B.	12278	40.50	54.00	7.20	—	12BB
11829	40.00	62.00	7.00	—	12BB	14350	40.00	70.00	12.00	—	15B.	.....	40.50	56.00	7.00	—	15BB
11534	40.00	62.00	7.00	—	15BB	14350	40.00	70.00	12.00	—	15BB	.....	40.80	44.05	3.10	—	14BA
11829	40.00	62.00	7.00	—	12BB	21877	40.00	70.00	12.00	—	15B.	16875	40.80	44.05	3.20	—	14BA
25447	40.00	62.00	8.00	—	15B	21878	40.00	70.00	19.00	—	15BB	12298	40.80	48.50	6.80	—	14BA
11324	40.00	62.00	8.00	—	12BB	.....	40.00	72.00	7.00	—	12BB	25429	41.00	47.00	4.10	—	14BB
20135	40.00	62.00	9.00	—	15BB	11242	40.00	72.00	7.00	—	15BB	12804	41.00	49.00	6.00	—	12BA
20135	40.00	62.00	9.00	—	15B.	21879	40.00	72.00	7.00	—	15BA	12275	41.00	49.40	6.50	—	12BA
14379	40.00	62.00	10.00	—	15BB	16539	40.00	72.00	7.00	—	12BB	.....	41.00	50.00	5.00	—	14BB
.....	40.00	62.00	10.00	—	12BB	11242	40.00	72.00	7.00	—	15C	12852	41.00	50.00	8.00	—	14BB
14379	40.00	62.00	10.00	—	15BB	21880	40.00	72.00	8.00	—	15BB	21896	41.00	52.00	7.00	—	15BA
14379	40.00	62.00	10.00	—	15BB	21881	40.00	72.00	9.00	—	15B.	.....	41.00	53.00	7.00	—	12BA
14379	40.00	62.00	10.00	—	15BA	.....	40.00	72.00	10.00	—	12BB	.....	41.00	56.00	7.00	—	15BA
14379	40.00	62.00	10.00	—	15B.	21884	40.00	72.00	10.00	—	15BB	.....	41.00	56.00	10.00	—	15BA
21864	40.00	62.00	10.00	—	12BB	14384	40.00	72.00	10.00	—	15BB	21897	41.00	60.00	8.50	—	15BB
11279	40.00	62.00	10.00	12.00	12BA	21882	40.00	72.00	10.00	—	15BA	16952	41.00	60.50	8.00	—	15BB
14379	40.00	62.00	10.00	—	15B.	21883	40.00	72.00	10.00	—	15B.	16031	41.00	62.00	10.00	—	15B.
14379	40.00	62.00	10.00	—	15BB	14384	40.00	72.00	11.00	—	15BA	.....	41.00	65.40	13.00	—	12BA
.....	40.00	62.00	11.50	—	15BB	.....	40.00	72.00	11.50	—	15BB	.....	41.00	65.45	13.00	—	12BA
.....	40.00	62.00	11.50	—	12BB	.....	40.00	72.00	11.50	—	12BB	16337	41.00	66.70	7.00	—	15BB
16105	40.00	62.00	11.50	—	15BB	.....	40.00	72.00	11.50	—	15B.	.....	41.00	74.00	12.00	—	15BB
17830	40.00	62.00	11.50	—	12BB	13237	40.00	72.00	12.00	—	12BA	16762	41.00	77.00	10.00	—	15BB
16105	40.00	62.00	11.50	—	15BB	21885	40.00	72.00	12.00	—	15BB	13339	41.10	62.00	16.00	—	12B.
21865	40.00	62.00	11.50	—	12BB	14385	40.00	72.00	12.00	—	15BA	.....	41.20	49.28	6.20	—	15BA
13326	40.00	62.00	12.00	—	12BA	14385	40.00	72.00	12.00	—	15B.	.....	41.20	56.00	6.35	—	15BB





# Retenfores

Perfis - Ver Última Página



INCOVE VEDAÇÕES LTDA.

Cod.	Di	De	Ha1	Ha2	Mod	Cod.	Di	De	Ha1	Ha2	Mod	Cod.	Di	De	Ha1	Ha2	Mod
.....	41.20	63.50	12.70	---	15BA	15889	41.28	60.33	14.29	---	13B.	15068	41.28	66.68	12.70	---	15B.
12648	41.20	63.65	8.00	---	12BA	.....	41.28	60.40	11.10	---	12BA	21928	41.28	66.68	12.70	---	12BB
21898	41.25	57.15	12.70	---	15BB	20276	41.28	61.00	12.70	---	15BB	14016	41.28	66.68	12.70	---	155
22453	41.27	60.32	9.52	---	12BB	21910	41.28	61.12	12.70	---	15BB	18536	41.28	66.68	15.88	---	12B.
18231	41.28	47.63	3.18	---	F	11380	41.28	61.52	7.94	---	12BA	18536	41.28	66.68	15.88	---	12BB
12700	41.28	47.63	3.18	---	14BA	.....	41.28	61.90	11.90	---	15BA	21929	41.28	67.47	9.53	---	15BB
21899	41.28	49.21	6.35	---	12BA	18533	41.28	61.91	6.35	---	14BA	19030	41.28	67.47	9.53	---	15BA
13062	41.28	50.80	4.76	---	14BA	18533	41.28	61.91	6.35	---	14BA	14715	41.28	68.26	7.94	---	180B
17407	41.28	50.80	5.16	---	18BB	12744	41.28	61.91	7.94	---	15BB	17367	41.28	68.26	9.53	---	CORT
12495	41.28	52.39	6.35	---	15B.	21911	41.28	61.91	7.94	---	12BA	14665	41.28	68.26	9.53	---	15BB
14061	41.28	53.58	38.10	---	REPA	15728	41.28	61.91	9.53	---	F	14024	41.28	68.26	11.11	14.29	113
.....	41.28	53.75	7.92	---	12BA	21912	41.28	61.91	11.11	---	15BA	15140	41.28	68.26	12.70	---	15BA
13470	41.28	53.93	7.94	---	15BB	21913	41.28	61.91	11.11	---	12BB	21930	41.28	68.26	12.70	---	15B.
13469	41.28	53.98	6.35	---	14BA	15035	41.28	61.91	11.91	---	15BB	15140	41.28	68.26	12.70	---	15C
18938	41.28	53.98	6.35	---	15BA	15035	41.28	61.91	11.91	---	15B.	15967	41.28	68.66	7.14	---	113
13470	41.28	53.98	7.94	---	14BB	15035	41.28	61.91	11.91	---	15BB	15027	41.28	69.06	10.32	---	113
21900	41.28	53.98	7.94	---	15B.	21914	41.28	61.91	11.91	---	15B.	.....	41.28	69.85	6.35	---	14BA
18280	41.28	53.98	9.53	---	14BA	15035	41.28	61.91	11.91	---	15BA	15625	41.28	69.85	6.35	---	14BA
21901	41.28	53.98	10.32	---	12BA	15035	41.28	61.91	11.91	---	15BB	15625	41.28	69.85	6.35	---	14C
18220	41.28	53.98	10.32	---	12B.	15035	41.28	61.91	11.91	---	15C	17390	41.28	69.85	9.53	---	F
21902	41.28	55.56	9.53	---	15BB	21915	41.28	61.91	12.70	---	15B.	21932	41.28	69.85	12.70	---	15B.
17965	41.28	55.56	9.53	---	15B.	21916	41.28	61.91	12.70	---	12BB	17183	41.28	69.85	19.05	---	11FB
17124	41.28	56.36	9.53	---	CORT	17830	41.28	61.91	12.70	---	12BB	15690	41.28	69.85	22.23	---	ESPE
12618	41.28	56.36	9.53	---	15BA	15710	41.28	61.91	12.70	---	113	15763	41.28	69.85	47.63	---	ESPE
21903	41.28	57.15	6.35	---	15BB	17630	41.28	61.91	15.08	---	13B.	.....	41.28	70.20	6.35	---	14BB
12734	41.28	57.15	6.35	---	15BA	12267	41.28	61.91	15.88	---	12B.	13115	41.28	70.64	7.94	---	14BA
12725	41.28	57.15	7.94	---	12BA	12267	41.28	61.91	15.88	---	12BB	12273	41.28	70.64	7.94	9.53	12BA
18034	41.28	57.15	9.53	---	F	21917	41.28	61.91	15.88	---	12B.	13115	41.28	70.64	7.94	---	14BA
18185	41.28	57.15	12.50	---	15BB	15410	41.28	61.91	19.05	---	11FB	21933	41.28	71.44	12.70	---	15BB
18185	41.28	57.15	12.50	---	15BB	15514	41.28	61.91	22.23	---	BOOT	18917	41.28	71.44	12.70	---	15BA
18185	41.28	57.15	12.50	---	15BB	15690	41.28	61.91	22.23	---	ESPE	21934	41.28	72.23	9.53	---	15BB
17557	41.28	57.15	12.70	---	15B.	15780	41.28	61.91	22.23	---	114	15910	41.28	72.23	9.53	---	15BA
17557	41.28	57.15	12.70	---	15B.	17432	41.28	61.91	23.02	---	19C	21935	41.28	72.23	12.70	---	15BB
15576	41.28	57.94	7.94	---	CORT	25378	41.28	63.33	9.50	---	12BB	18539	41.28	72.23	12.70	---	15B.
19992	41.28	58.74	7.94	---	15BA	18534	41.28	63.50	6.35	---	113	.....	41.28	73.02	11.90	---	12BB
12284	41.28	59.13	7.94	---	12BA	21918	41.28	63.50	6.35	---	15BB	15638	41.28	73.03	11.91	---	15BB
12284	41.28	59.13	7.94	---	12BA	21919	41.28	63.50	6.35	---	12BA	15638	41.28	73.03	11.91	---	15BA
18996	41.28	59.13	11.11	---	15B.	21920	41.28	63.50	7.94	---	15BB	15638	41.28	73.03	11.91	---	15B.
11327	41.28	59.13	11.11	---	12BA	21921	41.28	63.50	7.94	---	15BA	15638	41.28	73.03	11.91	---	15C
14683	41.28	59.53	11.11	---	113	18110	41.28	63.50	9.53	---	F	21936	41.28	73.03	12.70	---	15BB
13186	41.28	59.53	11.11	---	15BA	15965	41.28	63.50	9.53	---	15BB	21937	41.28	73.03	17.46	---	15B.
13186	41.28	59.53	11.11	---	15BA	21922	41.28	63.50	9.53	---	15BA	18540	41.28	73.03	17.46	---	11FC
.....	41.28	60.30	9.52	---	15BA	15965	41.28	63.50	9.53	---	15B.	17439	41.28	73.03	22.23	---	19B.
.....	41.28	60.30	11.11	---	15BA	15965	41.28	63.50	9.53	---	15BA	15293	41.28	73.82	19.84	---	ESPE
21904	41.28	60.33	6.35	---	15BB	15138	41.28	63.50	12.00	---	15B	12188	41.28	74.61	9.53	---	12BA
18286	41.28	60.33	7.94	---	15BA	15138	41.28	63.50	12.70	---	15BB	15531	41.28	75.75	6.35	---	14BA
18286	41.28	60.33	7.94	---	15BB	15138	41.28	63.50	12.70	---	15BA	15531	41.28	75.75	6.35	---	14BA
18286	41.28	60.33	7.94	---	15BA	21924	41.28	63.50	12.70	---	15BA	.....	41.28	75.84	6.35	---	15BA
18286	41.28	60.33	7.94	---	15B.	21923	41.28	63.50	12.70	---	15B.	17985	41.28	76.20	3.18	---	F
11450	41.28	60.33	7.94	---	12BB	17420	41.28	63.50	12.70	---	12BB	18541	41.28	76.20	12.70	---	113
18286	41.28	60.33	7.94	---	15BA	17420	41.28	63.50	12.70	---	12BA	15705	41.28	76.20	12.70	---	15BB
18286	41.28	60.33	7.94	---	15BB	15138	41.28	63.50	12.70	---	15C	15705	41.28	76.20	12.70	---	15B.
21906	41.28	60.33	8.33	---	15BB	18016	41.28	63.50	14.29	---	14C	17293	41.28	76.20	12.70	---	ESPE
16380	41.28	60.33	9.53	---	14BA	21925	41.28	63.50	17.46	---	15B.	15705	41.28	76.20	12.70	---	15B.
13279	41.28	60.33	9.53	---	15BB	13114	41.28	63.50	17.46	---	19B.	15705	41.28	76.20	12.70	---	15C
21908	41.28	60.33	9.53	---	12BA	13114	41.28	63.50	17.46	---	19BB	17293	41.28	76.20	12.70	---	ESPE
13279	41.28	60.33	9.53	---	15BB	18535	41.28	63.50	19.05	---	11FB	18300	41.28	76.20	15.88	---	11FC
11424	41.28	60.33	9.53	---	17BB	17440	41.28	63.50	22.23	---	19B.	15695	41.28	77.79	11.91	---	15B.
13279	41.28	60.33	9.53	---	15C	18325	41.28	64.29	7.54	---	ESPE	15695	41.28	77.79	11.91	---	15C
15973	41.28	60.33	11.11	---	F	13176	41.28	65.09	12.70	---	12BB	21938	41.28	79.38	12.70	---	15BA
21909	41.28	60.33	11.91	---	15B.	13176	41.28	65.09	12.70	---	12BA	17560	41.28	79.38	19.05	---	11FC
15141	41.28	60.33	12.70	---	15B.	21926	41.28	65.48	12.70	---	12BB	15980	41.28	79.38	22.23	---	F
15141	41.28	60.33	12.70	---	15BB	.....	41.28	66.62	12.70	---	15BA	17551	41.28	80.96	9.53	---	113
15141	41.28	60.33	12.70	---	15BB	18537	41.28	66.68	6.35	---	14B.	18542	41.28	80.96	11.11	---	15BB
15141	41.28	60.33	12.70	---	15B.	18537	41.28	66.68	6.35	---	14C	15163	41.28	82.55	12.70	---	15BB
15141	41.28	60.33	12.70	---	15B.	21927	41.28	66.68	9.53	---	12BA	.....	41.28	82.58	12.70	---	15BB
15141	41.28	60.33	12.70	---	15C	14025	41.28	66.68	9.53	---	12B.	18169	41.28	84.14	3.18	---	F





# Retentores

Perfis - Ver Última Página



INCOVE VEDAÇÕES LTDA.

Cod.	Di	De	Ha1	Ha2	Mod	Cod.	Di	De	Ha1	Ha2	Mod	Cod.	Di	De	Ha1	Ha2	Mod
21939	41.28	88.90	17.46	—	I2B.	14390	42.00	58.00	10.00	—	I5BB	21962	42.00	65.00	12.00	—	I5BB
17558	41.28	88.90	26.99	—	ESPE	14390	42.00	58.00	10.00	—	I5B.	14399	42.00	65.00	12.00	—	I5B.
15763	41.28	92.08	—	—	I13	12368	42.00	58.00	11.00	—	I2BA	14399	42.00	65.00	12.00	—	I5BA
21941	41.28	104.78	9.53	—	I2BB	.....	42.00	60.00	6.00	—	I2BB	14399	42.00	65.00	12.00	—	I5B.
18270	41.28	104.80	20.64	—	ESPE	.....	42.00	60.00	7.00	—	I2BB	14373	42.00	65.00	12.00	—	I2BB
17706	41.28	106.40	15.88	—	ESPE	.....	42.00	60.00	8.00	—	I2BB	21960	42.00	65.00	12.00	—	I2BA
17115	41.28	111.10	15.88	—	I55	21946	42.00	60.00	8.00	—	I5BB	14399	42.00	65.00	12.00	—	I5BB
15278	41.28	139.70	14.29	—	I13	16007	42.00	60.00	9.00	—	I2BB	17335	42.00	65.00	13.00	—	I5B
.....	41.30	54.00	6.50	—	I5BA	11666	42.00	60.00	9.00	—	I5BA	17335	42.00	65.00	13.00	—	I5B.
.....	41.30	54.00	6.50	—	I2BA	11666	42.00	60.00	9.00	—	I5B.	21963	42.00	65.00	13.00	—	I5B.
18286	41.30	60.60	8.00	—	I5BB	16294	42.00	60.00	9.00	—	I2BB	21964	42.00	65.20	10.00	—	I5BB
18286	41.30	60.60	8.00	—	I5BA	16498	42.00	60.00	9.00	—	I7BB	.....	42.00	66.00	8.00	—	I2BB
11380	41.30	61.50	8.00	—	I2BA	.....	42.00	60.00	10.00	—	I2BB	RB03	42.00	67.00	10.00	—	I2BB
15035	41.30	61.80	12.70	—	I5B.	.....	42.00	60.00	10.00	—	I5BB	.....	42.00	68.00	8.00	—	I2BB
16422	41.30	63.50	10.00	—	I7JM	.....	42.00	60.00	10.00	—	I2BB	21965	42.00	68.00	10.00	—	I5BB
11964	41.30	63.55	6.50	—	I2BA	21947	42.00	60.00	10.00	—	I5BB	21966	42.00	70.00	12.00	—	I5BB
15068	41.30	66.55	12.70	—	I5B.	21948	42.00	60.00	10.00	—	I5BA	22582	42.00	72.00	8.00	—	I5BB
15068	41.30	66.55	12.70	—	I5C	21949	42.00	60.00	10.00	—	I5BA	21967	42.00	72.00	8.00	—	I5BA
18538	41.30	70.10	12.70	—	I5B.	14391	42.00	60.00	10.00	—	I5B.	20302	42.00	72.00	8.00	—	I2BB
11982	41.35	60.35	9.52	—	I2BB	20374	42.00	60.00	12.00	—	I5BB	14400	42.00	72.00	10.00	—	I5BB
13874	41.37	62.00	12.50	—	I5BB	14392	42.00	60.00	12.00	—	I5BB	14400	42.00	72.00	10.00	—	I5BB
.....	41.40	70.60	7.90	—	I2BA	14392	42.00	60.00	12.00	—	I5B.	14400	42.00	72.00	10.00	—	I5BA
.....	41.50	63.40	10.00	—	I5BB	12977	42.00	60.00	14.00	—	I2BB	14400	42.00	72.00	10.00	—	I5BA
21942	41.67	55.56	7.94	—	I5BA	.....	42.00	62.00	6.00	—	I2BB	21968	42.00	72.00	10.00	—	I5B.
.....	41.67	73.73	14.00	—	I5BB	16670	42.00	62.00	6.00	—	I5BB	14401	42.00	72.00	12.00	—	I5BB
16467	42.00	50.00	7.00	—	I5BB	21951	42.00	62.00	6.00	—	I5BB	14401	42.00	72.00	12.00	—	I5BB
21943	42.00	50.00	8.00	—	I5BB	12881	42.00	62.00	7.00	—	I5BB	21969	42.00	72.00	12.00	—	I5BA
14387	42.00	50.00	10.00	—	I5BA	.....	42.00	62.00	7.00	—	I2BB	21970	42.00	72.00	12.00	—	I5B.
12160	42.00	52.00	4.00	—	I4BA	12887	42.00	62.00	7.00	—	I4BA	20291	42.00	72.00	12.00	—	I2BB
13892	42.00	52.00	5.00	—	I4BB	21952	42.00	62.00	7.00	—	I2BA	16845	42.00	73.50	9.50	—	I2BB
14400	42.00	52.00	10.00	—	I5BA	.....	42.00	62.00	8.00	—	I2BB	21971	42.00	78.00	8.00	—	I5BB
.....	42.00	53.00	7.00	—	I2BB	12573	42.00	62.00	8.00	—	I5BB	12476	42.00	80.00	12.00	—	I5BB
.....	42.00	53.00	8.00	—	I2BA	21953	42.00	62.00	8.00	—	I5BA	21972	42.00	80.00	12.00	—	I5BB
13149	42.00	54.00	7.00	—	I55B	12573	42.00	62.00	8.00	—	I5BA	20096	42.00	80.00	13.00	—	I5B.
.....	42.00	55.00	7.00	—	I2BA	11636	42.00	62.00	8.00	—	I2BB	16273	42.00	86.00	10.00	—	I5BB
.....	42.00	55.00	7.00	—	I2BB	11636	42.00	62.00	8.00	—	I2BB	14809	42.06	66.72	12.70	—	ESPE
12972	42.00	55.00	7.00	—	I5BB	14393	42.00	62.00	10.00	—	I5B	14809	42.06	66.72	12.70	—	I5C
12972	42.00	55.00	7.00	—	I5BA	.....	42.00	62.00	10.00	—	I5BB	17721	42.07	61.91	15.88	—	ESPE
12972	42.00	55.00	7.00	—	I5B.	14393	42.00	62.00	10.00	—	I5BB	21973	42.07	63.50	9.53	—	I5BA
13862	42.00	55.00	8.00	—	I5BB	14393	42.00	62.00	10.00	—	I5BB	15560	42.07	66.28	7.14	—	I13
13862	42.00	55.00	8.00	—	I5BB	21954	42.00	62.00	10.00	—	I5BA	15390	42.07	68.26	12.70	—	I5BB
21944	42.00	55.00	8.00	—	I5BA	21955	42.00	62.00	10.00	—	I5B.	21974	42.07	68.26	12.70	—	I5BA
11331	42.00	55.00	8.00	—	I2BB	14395	42.00	62.00	10.00	—	I5T.	11813	42.40	63.40	12.00	—	I2BB
.....	42.00	55.00	9.00	—	I2BA	14393	42.00	62.00	10.00	—	I5BB	17182	42.80	68.15	10.70	—	I5BA
.....	42.00	55.00	9.00	—	I2BB	21956	42.00	62.00	11.00	—	I2BB	21975	42.86	53.98	11.91	—	I5BB
.....	42.00	55.00	9.00	—	I2BA	.....	42.00	62.00	12.00	—	I5BA	19005	42.86	53.98	11.91	—	I5B.
S2058	42.00	55.00	9.00	—	I2BA	14394	42.00	62.00	12.00	—	I5BA	13541	42.86	57.15	6.35	—	ESPE
11556	42.00	55.00	10.00	—	I5BB	14394	42.00	62.00	12.00	—	I5BB	15702	42.86	57.15	7.94	—	F
14388	42.00	56.00	7.00	—	I5BB	14394	42.00	62.00	12.00	—	I5BA	21976	42.86	57.94	6.35	—	I5BA
.....	42.00	56.00	7.00	—	I2BB	21959	42.00	62.00	12.00	—	I5B.	15809	42.86	57.94	9.53	—	I5C
.....	42.00	56.00	7.00	—	I2BB	21957	42.00	62.00	12.00	—	I2BB	15809	42.86	57.94	9.53	—	I5BA
14388	42.00	56.00	7.00	—	I5BB	21958	42.00	62.00	12.00	—	I2BA	21977	42.86	57.94	12.70	—	I5BB
.....	42.00	56.00	7.00	—	I2BA	14395	42.00	63.00	10.00	—	I80B	15260	42.86	57.94	12.70	—	ESPE
14388	42.00	56.00	7.00	—	I5BB	13557	42.00	63.00	13.00	—	I5BA	21978	42.86	58.74	7.94	—	I5BB
13149	42.00	56.00	7.00	—	I5BB	11708	42.00	64.00	8.00	—	I5BB	16996	42.86	58.74	8.00	—	I5BA
14388	42.00	56.00	7.00	—	I5BA	14396	42.00	64.00	14.00	—	I5BA	21979	42.86	58.74	11.91	—	I5B.
14388	42.00	56.00	7.00	—	I5BB	.....	42.00	65.00	8.00	—	I2BB	21980	42.86	59.13	9.53	—	I5BA
11442	42.00	57.00	9.00	—	I5BB	14397	42.00	65.00	10.00	—	I5BB	21981	42.86	59.13	12.70	—	I5BA
14389	42.00	57.00	10.00	—	I5B.	14397	42.00	65.00	10.00	—	I5BB	21982	42.86	60.33	6.35	—	I5BB
14389	42.00	57.00	10.00	—	I5BA	14397	42.00	65.00	10.00	—	I5BB	19036	42.86	60.33	9.53	—	I5BA
.....	42.00	57.50	9.00	—	I5BB	14397	42.00	65.00	10.00	—	I5BA	19036	42.86	60.33	9.53	—	I5BA
.....	42.00	58.00	7.00	—	I5BA	14397	42.00	65.00	10.00	—	I5B.	15895	42.86	60.33	11.11	—	REPA
12716	42.00	58.00	7.00	—	I5BA	14398	42.00	65.00	10.00	12.00	I2BB	21983	42.86	61.91	12.70	—	I5BB
12716	42.00	58.00	7.00	—	I5BA	14398	42.00	65.00	10.00	12.00	I2BB	16965	42.86	61.91	12.70	—	I7B.
.....	42.00	58.00	7.00	—	I2BB	14399	42.00	65.00	12.00	—	I5B	18543	42.86	61.91	15.08	—	I2BA
.....	42.00	58.00	8.00	—	I2BB	.....	42.00	65.00	12.00	—	I5BA	18543	42.86	61.91	15.08	—	I2BA
21945	42.00	58.00	9.00	—	I5BA	14373	42.00	65.00	12.00	—	I2BA	15292	42.86	63.50	6.35	—	I13



# Retenfores

Perfis - Ver Última Página



INCOVE VEDAÇÕES LTDA.

Cod.	Di	De	Ha1	Ha2	Mod	Cod.	Di	De	Ha1	Ha2	Mod	Cod.	Di	De	Ha1	Ha2	Mod
11837	42.86	63.50	6.35	—	I4BA	17129	42.86	80.96	11.11	—	I5C	16301	43.66	73.03	11.91	—	I2BB
22000	42.86	63.50	7.94	—	I5BA	21994	42.86	80.96	11.91	—	I5BB	15774	43.66	74.61	21.43	—	ESPE
15561	42.86	63.50	7.94	—	I4C	21995	42.86	80.96	12.70	—	I5BB	15330	43.66	75.41	6.35	—	I4BA
22001	42.86	63.50	9.53	—	I5B.	21996	42.86	80.96	12.70	—	I5BA	22013	43.66	75.41	9.53	—	I5BB
16408	42.86	63.50	9.53	—	I2BA	17779	42.86	80.96	38.10	—	ESPE	17366	43.66	75.41	9.53	—	CORT
13254	42.86	63.50	9.53	—	I5BA	15731	42.86	84.14	12.70	—	I13	14724	43.66	77.15	12.70	—	I5C
13254	42.86	63.50	9.53	—	I5BA	19923	42.86	85.73	7.94	—	I80	17644	43.66	108.00	15.08	—	I55
15046	42.86	63.50	12.70	—	I5BB	21997	42.86	88.90	11.91	—	I5BB	15278	43.66	114.70	14.29	—	ESPE
14827	42.86	63.50	12.70	—	I550	21998	42.86	88.90	11.91	—	I5B.	15049	43.70	71.90	9.00	21.60	I550
15046	42.86	63.50	12.70	—	I5C	17946	42.86	88.90	12.70	—	I5B.	25435	44.00	52.00	7.00	—	I2BB
15340	42.86	63.50	19.05	—	I1BF	21999	42.89	63.50	7.94	—	I5B.	16745	44.00	55.00	7.00	—	I5BB
15340	42.86	63.50	19.05	—	I1FC	12837	42.90	61.75	7.00	—	I5BA	12961	44.00	56.00	7.00	—	I5BB
11837	42.86	63.57	6.40	—	I4BA	13254	42.90	63.65	9.50	—	I5BB	16344	44.00	58.00	7.00	—	I5BA
15338	42.86	65.09	6.35	—	F	12322	42.90	65.00	9.50	—	I2BA	14407	44.00	58.00	10.00	—	I5BA
21985	42.86	65.09	7.94	—	I5BB	12322	42.90	65.00	9.50	15.00	I2BA	14407	44.00	58.00	10.00	—	I5BA
18255	42.86	65.09	7.94	—	I5B.	22002	43.00	52.00	6.00	—	I5BB	22014	44.00	58.00	11.00	—	I5BB
21986	42.86	65.09	11.91	—	I5B.	—	43.00	52.00	6.50	—	I5BA	22015	44.00	60.00	9.00	—	I2BB
17975	42.86	65.09	12.70	—	ESPE	—	43.00	52.00	6.50	—	I4BA	14408	44.00	60.00	10.00	—	I5BB
12369	42.86	66.68	9.53	—	I5BB	22003	43.00	52.00	9.50	—	I5BB	14408	44.00	60.00	10.00	—	I5BB
21987	42.86	66.68	9.53	—	I5BB	14402	43.00	52.00	10.00	—	I5BB	12232	44.00	60.00	10.00	—	I2BA
15018	42.86	66.68	9.53	—	I4BA	12161	43.00	53.00	4.00	—	I4BA	14408	44.00	60.00	10.00	—	I5BB
12369	42.86	66.68	9.53	—	I5B.	12624	43.00	54.00	7.50	—	I5BA	22018	44.00	60.00	10.00	—	I5BB
15018	42.86	66.68	9.53	—	I4C	16335	43.00	54.00	12.00	—	I5BB	22016	44.00	60.00	10.00	—	I5B.
17063	42.86	66.68	12.70	—	I5BB	16335	43.00	54.00	12.00	—	I5BA	22017	44.00	60.00	10.00	—	I5B.
17063	42.86	66.68	12.70	—	I5BA	16370	43.00	56.00	7.00	—	I5BB	12232	44.00	60.00	10.00	—	I2BA
17063	42.86	66.68	12.70	—	I5B.	15809	43.00	58.00	9.00	—	I5BA	13703	44.00	62.00	8.00	—	I5BB
15947	42.86	66.68	19.05	—	I1FC	15809	43.00	58.00	9.00	—	I5C	17657	44.00	62.00	8.00	—	I2BA
15419	42.86	67.47	8.74	—	I4	19992	43.00	58.80	8.00	—	I5BA	17657	44.00	62.00	8.00	—	I2BA
21988	42.86	68.26	10.72	—	I5BA	14403	43.00	60.00	10.00	—	I5BB	13211	44.00	62.30	9.00	—	I4BB
17031	42.86	68.26	12.70	—	I5BB	22004	43.00	60.00	10.00	—	I5B.	11281	44.00	64.70	12.70	—	I2BA
17031	42.86	68.26	12.70	—	I5BA	22005	43.00	61.50	9.50	—	I5BA	22019	44.00	65.00	10.00	—	I5BA
17031	42.86	68.26	12.70	—	I5B.	14404	43.00	62.00	8.00	—	I5BA	22020	44.00	65.00	10.00	—	I5B.
17031	42.86	68.26	12.70	—	I5C	14404	43.00	62.00	8.00	—	I5BA	12319	44.00	65.00	12.00	—	ESPE
14771	42.86	68.26	12.70	—	I80B	22006	43.00	62.00	9.00	—	I5BB	11959	44.00	65.00	12.00	—	I2BB
18213	42.86	68.26	19.05	—	I1BF	15834	43.00	62.00	10.00	—	I5BB	12319	44.00	65.20	12.00	—	ESPE
17032	42.86	68.26	82.23	—	I9B.	14405	43.00	62.00	10.00	—	I5BB	11653	44.00	66.00	10.00	—	I5BB
17234	42.86	69.06	11.91	—	I5BA	22008	43.00	62.00	10.00	—	I5BA	22564	44.00	67.00	8.00	—	I5BA
17371	42.86	69.45	13.49	—	I13	22007	43.00	62.00	10.00	—	I5B.	14409	44.00	69.00	5.00	—	I4B.
15517	42.86	69.85	11.91	—	I13	11951	43.00	62.00	12.00	—	I5BA	22021	44.00	69.00	5.00	—	I5BA
15781	42.86	69.85	12.70	—	I5B.	13734	43.00	62.00	16.00	—	I2B.	22022	44.00	70.00	13.00	—	I5BB
15781	42.86	69.85	12.70	—	I5B.	13767	43.00	64.00	12.50	—	I5BA	13997	44.00	72.00	9.00	—	I13
15781	42.86	69.85	12.70	—	I5C	16694	43.00	67.00	10.00	—	I5BB	20355	44.00	72.00	10.00	—	I5BB
13643	42.86	69.85	17.46	—	I7B.	16303	43.00	67.00	12.00	—	I2JL	22024	44.00	72.00	12.00	—	I5B.
18902	42.86	69.85	19.05	—	I1	18544	43.00	69.80	6.00	—	I4BA	11893	44.00	73.15	12.70	—	I2B
18545	42.86	70.64	13.49	—	I5BB	22490	43.00	70.00	8.00	—	I5BA	11893	44.00	73.15	12.70	—	I2B.
12837	42.86	71.44	7.14	—	I5BA	22008	43.00	70.00	13.00	—	I5BB	11865	44.00	75.00	8.00	—	I5BB
17435	42.86	71.44	12.70	—	I13	22491	43.00	71.00	8.00	—	I5BA	16253	44.00	75.00	12.00	—	I2BB
18546	42.86	72.23	7.14	—	I4	22009	43.00	72.00	12.00	—	I5BB	22025	44.00	77.00	13.00	—	I5BB
21990	42.86	72.23	11.91	—	I5BB	14406	43.00	72.00	12.00	—	I5B.	14410	44.00	80.00	12.00	—	I5BA
18547	42.86	72.23	13.49	—	I5B.	12982	43.00	72.00	12.00	—	I2BA	22027	44.00	80.00	12.00	—	I5BA
15346	42.86	72.23	13.89	—	I5C	—	43.00	75.00	10.00	—	I2BB	14410	44.00	80.00	12.00	—	I5B.
15753	42.86	72.63	7.94	—	I13	12323	43.40	56.00	9.00	—	I2BA	25412	44.00	92.50	12.00	—	I5BB
15634	42.86	73.03	11.91	—	I5BA	16807	43.50	63.00	12.00	—	I5BB	22028	44.05	62.31	6.35	—	I5BB
15608	42.86	73.03	12.70	—	ESPE	15125	43.66	53.98	8.73	—	F	15426	44.05	69.45	12.70	—	I4
15634	42.86	73.03	12.70	—	I5B	15702	43.66	56.36	7.94	—	F	17404	44.05	77.79	12.70	—	I5BB
15356	42.86	73.03	15.88	—	ESPE	17399	43.66	61.91	6.35	—	I4	17404	44.05	77.79	12.70	—	I5C
18548	42.86	73.03	17.46	—	I1BF	15156	43.66	61.91	11.91	—	I5C	15968	44.05	77.79	19.05	—	I1FC
17439	42.86	73.03	22.23	—	I9	12370	43.66	62.31	6.35	—	I5BB	.....	44.30	60.00	7.00	—	I5BB
17542	42.86	74.22	12.70	—	I13	15453	43.66	62.31	6.35	—	I4BA	11929	44.30	81.00	12.50	—	I5BB
18242	42.86	76.20	12.70	—	I5BB	15453	43.66	62.31	6.35	—	I4C	—	44.40	63.50	12.50	—	I2BA
21991	42.86	77.79	12.70	—	I5BB	15172	43.66	66.68	12.70	—	I5BB	—	44.40	63.50	12.70	—	I2BA
17661	42.86	77.79	12.70	—	I5BA	15102	43.66	68.26	12.70	—	I5B.	11247	44.45	50.80	3.18	—	I4BA
15552	42.86	77.79	15.88	—	I3	22010	43.66	68.26	12.70	—	I5BB	15437	44.45	53.98	4.76	—	I5BA
21993	42.86	79.38	12.70	—	I5BB	17200	43.66	69.85	12.70	—	I5B.	16385	44.45	53.98	4.76	—	I4B.
18549	42.86	79.38	12.70	—	I5BA	15346	43.66	73.03	9.53	—	I5C	16385	44.45	53.98	4.76	—	I4B.
18285	42.86	79.38	15.88	—	SANF	17250	43.66	73.03	11.91	—	I5B.	15437	44.45	53.98	4.76	—	I5BB
18550	42.86	80.17	6.35	—	I13	22011	43.66	73.03	11.91	—	I5BB	22029	44.45	53.98	4.76	—	I5BA



# Retentores

Perfis - Ver Última Página



INCOVE VEDAÇÕES LTDA.

Cod.	Di	De	Ha1	Ha2	Mod	Cod.	Di	De	Ha1	Ha2	Mod	Cod.	Di	De	Ha1	Ha2	Mod
22030	44.45	53.98	7.54	—	12BA	12374	44.45	61.91	11.91	—	15BA	22053	44.45	66.68	12.70	—	15B.
17958	44.45	57.15	4.76	—	15BB	12375	44.45	61.91	12.70	—	15B	11728	44.45	66.68	12.70	—	12BA
17958	44.45	57.15	4.76	—	15B.	17197	44.45	61.91	12.70	—	15BB	15238	44.45	66.68	12.70	—	ESPE
15626	44.45	57.15	6.35	—	113	17197	44.45	61.91	12.70	—	15B.	15155	44.45	66.68	12.70	—	15C
22031	44.45	57.15	6.35	—	15BA	17461	44.45	61.91	12.70	—	113	16673	44.45	66.68	15.88	—	15JM
11212	44.45	57.15	6.35	—	14C	17197	44.45	61.91	12.70	—	15BA	15392	44.45	66.68	15.88	—	12BB
15893	44.45	57.15	7.94	—	15B.	17197	44.45	61.91	12.70	—	15BB	22055	44.45	66.68	15.88	—	12B.
19945	44.45	57.15	7.94	—	12BB	17888	44.45	61.91	21.43	—	ESPE	15392	44.45	66.68	15.88	—	12B.
19945	44.45	57.15	7.94	—	12BA	11111	44.45	62.00	7.90	—	12BA	17781	44.45	66.68	17.86	—	112C
19945	44.45	57.15	7.94	—	12B.	19500	44.45	63.50	4.76	—	14BA	17150	44.45	66.68	19.05	—	11FC
14706	44.45	57.15	9.00	—	12B.	15473	44.45	63.50	6.35	—	F	15707	44.45	68.26	4.76	—	F
14706	44.45	57.15	9.00	—	14BA	13124	44.45	63.50	7.93	—	15BA	18555	44.45	68.26	6.35	—	14
16697	44.45	57.15	9.12	—	15BA	13124	44.45	63.50	7.94	—	15BA	11051	44.45	68.26	6.35	—	15BB
13825	44.45	57.15	9.53	—	15BB	13124	44.45	63.50	7.94	—	15BB	19994	44.45	68.26	11.91	—	12BA
13825	44.45	57.15	9.53	—	15BB	13124	44.45	63.50	7.94	—	15BA	19994	44.45	68.26	11.91	—	12BA
22032	44.45	57.15	9.53	—	15B.	12948	44.45	63.50	7.94	—	12BB	15828	44.45	68.26	12.60	—	180B
22033	44.45	57.15	9.53	—	12BB	13124	44.45	63.50	7.94	—	15B.	15828	44.45	68.26	12.70	—	180B
14706	44.45	57.15	9.53	—	12BA	15118	44.45	63.50	9.53	—	15BB	15394	44.45	68.26	12.70	—	15B.
14706	44.45	57.15	9.53	—	12B.	15118	44.45	63.50	9.53	—	15BB	15394	44.45	68.26	12.70	—	15BA
13825	44.45	57.15	9.53	—	15BB	22047	44.45	63.50	9.53	—	15BA	22056	44.45	68.26	12.70	—	15B.
22034	44.45	57.15	11.91	—	15B.	15118	44.45	63.50	9.53	—	15B.	11566	44.45	68.26	12.70	—	12BB
15539	44.45	57.15	12.70	—	15BB	13820	44.45	63.50	9.53	—	12BA	22057	44.45	68.26	12.70	—	12B.
17537	44.45	57.15	12.70	—	F	15118	44.45	63.50	9.53	—	15BA	15394	44.45	68.26	12.70	—	15C
15539	44.45	57.15	12.70	—	15B.	15118	44.45	63.50	9.53	—	15BB	15828	44.45	68.26	12.70	—	180C
11702	44.45	57.15	12.70	—	12BB	13820	44.45	63.50	9.53	—	12BA	14765	44.45	68.26	15.88	—	12BB
18100	44.45	57.15	14.29	—	F	15118	44.45	63.50	9.53	—	15B.	14765	44.45	68.26	15.88	—	12BB
18292	44.45	57.94	6.35	—	15BB	22201	44.45	63.50	11.11	—	12BB	22058	44.45	68.26	15.88	—	12BA
22036	44.45	57.94	6.35	—	15BA	17550	44.45	63.50	12.70	—	F	14765	44.45	68.26	15.88	—	12B.
18292	44.45	57.94	6.35	—	15B.	17133	44.45	63.50	12.70	—	15B.	14765	44.45	68.26	15.88	—	12B.
22037	44.45	57.94	9.13	—	15BA	17133	44.45	63.50	12.70	—	15BB	15394	44.45	68.30	12.70	—	15B.
12371	44.45	59.53	6.35	—	14B.	17133	44.45	63.50	12.70	—	15BB	15394	44.45	68.30	12.70	—	15C
17527	44.45	59.53	6.35	—	15BB	17718	44.45	63.50	12.70	—	15B.	17234	44.45	69.05	11.91	—	12BA
11434	44.45	60.20	11.00	—	15BA	22049	44.45	63.50	12.70	—	15B.	22059	44.45	69.06	9.53	—	15BA
16456	44.45	60.33	6.35	—	15B.	17718	44.45	63.50	12.70	—	12BB	22060	44.45	69.06	10.32	—	15BA
11632	44.45	60.33	7.94	—	15BA	17718	44.45	63.50	12.70	—	12BA	20060	44.45	69.06	10.32	—	15B.
17960	44.45	60.33	9.53	—	15BB	17718	44.45	63.50	12.70	—	12BA	17582	44.45	69.06	10.32	—	113
17960	44.45	60.33	9.53	—	15BB	22048	44.45	63.50	12.70	—	12B.	22061	44.45	69.06	12.70	—	15BB
17960	44.45	60.33	9.53	—	15BA	17133	44.45	63.50	12.70	—	15C	22062	44.45	69.06	12.70	—	12BA
17960	44.45	60.33	9.53	—	15BA	15370	44.45	63.50	13.49	—	113	18556	44.45	69.06	12.70	—	12B.
15324	44.45	60.33	11.11	—	F	14773	44.45	63.50	14.29	17.46	ESPE	15426	44.45	69.45	12.70	—	14BA
22038	44.45	60.33	11.91	—	15B.	17091	44.45	63.50	15.88	—	13BC	15426	44.45	69.45	12.70	—	14C
15534	44.45	60.33	15.88	—	ESPE	18533	44.45	63.50	19.05	—	112	18557	44.45	69.85	6.35	—	14BA
17226	44.45	60.33	33.34	—	ESPE	19917	44.45	64.29	11.11	—	ESPE	18557	44.45	69.85	6.35	—	14B.
13276	44.45	61.12	9.53	—	15BA	15865	44.45	64.29	22.22	—	155	16339	44.45	69.85	7.94	—	15BB
11119	44.45	61.12	9.53	—	12BA	15865	44.45	64.29	22.22	—	15BA	14748	44.45	69.85	9.52	—	15BA
11119	44.45	61.12	9.53	—	12BA	22050	44.45	65.09	7.94	—	15BB	14748	44.45	69.85	9.52	—	12B.
13276	44.45	61.12	9.53	—	15BA	18551	44.45	65.09	12.00	—	15BB	14748	44.45	69.85	9.53	—	15BB
22039	44.45	61.12	11.11	—	15BB	18551	44.45	65.09	12.00	—	15BB	15214	44.45	69.85	12.70	—	15B.
16537	44.45	61.19	11.91	—	15B.	18551	44.45	65.09	12.70	—	15BA	15214	44.45	69.85	12.70	—	15B.
15119	44.45	61.52	12.70	—	15BA	14079	44.45	65.09	12.70	—	113	15214	44.45	69.85	12.70	—	15JM
12958	44.45	61.91	5.00	—	15BB	18551	44.45	65.09	12.70	—	15BA	15214	44.45	69.85	12.70	—	15BB
12372	44.45	61.91	6.35	—	15BA	22051	44.45	65.09	13.49	—	15BA	20113	44.45	69.85	12.70	—	12BB
12372	44.45	61.91	6.35	—	15BA	11473	44.45	65.09	14.29	—	12BA	15214	44.45	69.85	12.70	—	15C
15827	44.45	61.91	6.35	—	14C	17904	44.45	65.09	15.88	—	11BF	12376	44.45	69.85	14.29	—	15BA
12373	44.45	61.91	7.94	—	15BB	18554	44.45	66.68	6.35	—	14B.	17274	44.45	69.85	15.88	—	12B.
11111	44.45	61.91	7.94	—	12BB	11416	44.45	66.68	6.35	—	15BB	17207	44.45	69.85	17.46	—	112C
15558	44.45	61.91	7.94	—	F	13651	44.45	66.68	7.94	—	1816	17687	44.45	69.85	19.05	—	11BF
12373	44.45	61.91	7.94	—	15BB	15381	44.45	66.68	9.53	—	113	17687	44.45	69.85	19.05	—	11FC
15834	44.45	61.91	9.53	—	15BA	22052	44.45	66.68	9.53	—	15BB	17476	44.45	69.85	23.81	—	17BA
15834	44.45	61.91	9.53	—	15B.	18056	44.45	66.68	9.53	—	15B.	17476	44.45	69.85	23.81	—	17B.
22041	44.45	61.91	9.53	—	12BB	18056	44.45	66.68	9.53	—	15B.	18558	44.45	69.85	23.81	—	19B.
22042	44.45	61.91	9.53	—	12BA	17253	44.45	66.68	12.70	—	F	17476	44.45	69.85	23.81	—	17C
15834	44.45	61.91	9.53	—	15BA	15155	44.45	66.68	12.70	—	15BB	22536	44.45	69.95	7.92	—	12BA
22043	44.45	61.91	11.11	—	15BA	12241	44.45	66.68	12.70	—	ESPE	11700	44.45	70.02	9.50	—	12BB
22045	44.45	61.91	11.91	—	15BB	15155	44.45	66.68	12.70	—	15JM	17059	44.45	70.25	6.35	—	14C
22044	44.45	61.91	11.91	—	15BA	22054	44.45	66.68	12.70	—	15BB	15132	44.45	70.25	12.70	—	15BB
22046	44.45	61.91	11.91	—	15B.	15155	44.45	66.68	12.70	—	15BB	15132	44.45	70.25	12.70	—	15C



# Retenfores

Perfis - Ver Última Página



INCOVE VEDAÇÕES LTDA.

Cod.	Di	De	Ha1	Ha2	Mod	Cod.	Di	De	Ha1	Ha2	Mod	Cod.	Di	De	Ha1	Ha2	Mod
18552	44.45	70.64	12.70	—	15BB	17055	44.45	77.79	12.70	—	15B.	13815	45.00	54.00	8.00	8.70	12BA
17606	44.45	70.64	12.70	—	15BA	14064	44.45	79.38	11.91	—	15BA	16043	45.00	54.00	10.00	—	15B.
17606	44.45	70.64	12.70	—	15BA	15175	44.45	79.38	12.70	—	F	20043	45.00	55.00	4.00	—	14BB
15508	44.45	70.64	12.70	—	ESPE	22073	44.45	79.38	12.70	—	15BB	12163	45.00	55.00	4.00	—	14BA
15508	44.45	70.64	12.70	—	180B	14064	44.45	79.38	12.70	—	15B.	16893	45.00	55.00	4.00	—	15BB
15508	44.45	70.64	12.70	—	180C	15845	44.45	79.38	14.29	—	ESPE	11364	45.00	55.00	7.00	—	14BA
15345	44.45	71.44	6.35	—	F	18563	44.45	80.17	6.35	—	14C	22086	45.00	55.00	7.00	—	15BB
14681	44.45	71.44	12.70	—	12BB	22074	44.45	80.17	11.11	—	15BA	13903	45.00	55.00	7.00	—	15BA
14681	44.45	71.44	12.70	—	12BB	15418	44.45	80.57	19.05	—	11BF	22087	45.00	55.00	8.00	—	15BA
14681	44.45	71.44	12.70	—	12BA	15641	44.45	80.96	11.11	—	15BA	13995	45.00	55.00	10.00	—	15BB
18559	44.45	71.44	12.70	—	113	15641	44.45	80.96	11.91	—	15B.	13995	45.00	55.00	10.00	—	15BA
22064	44.45	71.44	12.70	—	15BB	15641	44.45	80.96	11.91	—	15C	11364	45.00	55.28	7.00	—	14BA
18294	44.45	71.44	12.70	—	15BA	18910	44.45	80.96	12.70	—	18C	RU28	45.00	56.00	6.60	—	12
14681	44.45	71.44	12.70	—	12BB	22075	44.45	80.96	12.70	—	15BB	19945	45.00	56.00	7.00	—	15BB
14681	44.45	71.44	12.70	—	12BB	18323	44.45	80.96	12.70	—	15B.	13148	45.00	57.00	7.50	—	155B
11261	44.45	71.44	14.68	—	15BB	12964	44.45	80.96	13.49	—	15BB	11057	45.00	57.00	12.00	—	15BB
22066	44.45	71.44	15.08	—	12BB	18564	44.45	80.96	19.05	—	11BF	13200	45.00	58.00	7.00	—	15BB
22065	44.45	71.44	15.08	—	12BA	17703	44.45	82.55	12.70	—	155C	13200	45.00	58.00	7.00	—	15BB
15306	44.45	72.23	6.35	—	15BB	17703	44.45	82.55	12.70	—	15BB	11270	45.00	58.00	7.00	—	12BB
12378	44.45	72.23	6.35	—	14BA	15731	44.45	84.14	12.70	—	113	13200	45.00	58.00	7.00	—	15BB
15306	44.45	72.23	6.35	—	113	18187	44.45	84.93	12.70	—	CORT	16847	45.00	58.00	9.00	—	15BB
14769	44.45	72.23	9.53	19.05	ESPE	15877	44.45	85.73	15.88	—	ESPE	14778	45.00	59.00	5.50	8.00	113
18175	44.45	73.03	4.76	—	F	15877	44.45	85.73	15.88	—	112C	22089	45.00	59.00	10.00	—	12BB
11141	44.45	73.03	9.53	—	12BA	18160	44.45	90.49	6.35	—	F	14419	45.00	59.00	10.00	15.00	ESPE
11141	44.45	73.03	9.53	—	12BB	18565	44.45	90.49	12.70	—	15BB	14411	45.00	60.00	7.00	9.00	15B
22067	44.45	73.03	11.11	—	15B.	18565	44.45	90.49	12.70	—	15B.	13238	45.00	60.00	7.00	—	12BB
15178	44.45	73.03	11.91	—	15C	22076	44.45	92.08	11.91	—	15B.	13143	45.00	60.00	7.00	—	12BB
15178	44.45	73.03	11.91	—	15B.	18085	44.45	92.08	12.70	—	15B.	13489	45.00	60.00	7.00	—	14BA
15178	44.45	73.03	11.91	—	15BB	12487	44.45	95.25	11.91	—	15B.	14411	45.00	60.00	7.00	—	15BB
22068	44.45	73.03	11.91	—	15B.	17464	44.45	98.43	22.23	—	155B	22090	45.00	60.00	7.00	—	15BA
12757	44.45	73.03	11.91	—	12B.	22077	44.45	100.01	9.13	—	15BB	14411	45.00	60.00	7.00	—	15B.
15178	44.45	73.03	11.91	—	15C	17895	44.45	104.80	4.76	—	F	14411	45.00	60.00	7.00	—	15BB
19009	44.45	73.03	12.70	—	180	17369	44.45	111.10	18.26	—	155	14411	45.00	60.00	7.00	—	15BA
11377	44.45	73.03	12.70	—	15BA	22078	44.45	117.47	19.05	—	15B.	14411	45.00	60.00	7.00	—	15BB
22069	44.45	73.03	12.70	—	15B.	15772	44.45	117.50	19.05	—	155	12562	45.00	60.00	8.00	—	15BB
11893	44.45	73.03	12.70	—	12BA	15372	44.45	122.20	31.75	—	155	12562	45.00	60.00	8.00	—	15BB
15185	44.45	73.03	12.70	—	ESPE	17462	44.45	123.80	19.05	—	155C	11274	45.00	60.00	8.00	—	12BB
11377	44.45	73.03	12.70	—	15BA	16008	44.48	61.88	8.00	—	12BB	12562	45.00	60.00	8.00	—	15BA
15185	44.45	73.03	12.70	—	ESPE	13089	44.50	49.00	16.00	—	ESPE	.....	45.00	60.00	8.00	—	12BB
15361	44.45	73.03	14.29	—	113	22079	44.50	57.00	9.00	—	12B.	11274	45.00	60.00	8.00	—	12BB
15829	44.45	73.03	15.88	—	13B.	11372	44.50	57.30	12.00	—	15B.	13814	45.00	60.00	9.00	—	12BB
14717	44.45	73.03	15.88	—	17BB	25397	44.50	58.80	10.00	—	ESPE	11775	45.00	60.00	9.00	—	15JM
14717	44.45	73.03	15.88	—	17B.	25405	44.50	60.00	10.00	—	19B	11775	45.00	60.00	9.00	—	15BB
15936	44.45	73.03	17.46	—	15B.	20101	44.50	60.80	10.00	—	15B.	11775	45.00	60.00	9.00	—	15B.
15936	44.45	73.03	17.46	—	ESPE	13822	44.50	61.90	9.50	—	12BA	13814	45.00	60.00	9.00	—	12BA
19948	44.45	73.03	20.64	—	17B.	11111	44.50	62.00	8.00	—	12BB	13814	45.00	60.00	9.00	—	12BB
18566	44.45	74.61	4.76	—	14	12958	44.50	62.20	5.00	—	15BB	13821	45.00	60.00	10.00	—	12BB
17539	44.45	74.61	23.81	—	F	11617	44.50	62.50	9.50	—	12BB	14412	45.00	60.00	10.00	—	15B.
14699	44.45	75.41	6.35	—	113	12533	44.50	63.50	12.50	—	17B.	14412	45.00	60.00	10.00	—	15BB
15411	44.45	75.80	19.05	—	11BF	14115	44.50	71.00	13.00	—	14BA	14412	45.00	60.00	10.00	—	15BA
14838	44.45	76.20	6.35	—	14BA	14115	44.50	71.00	13.00	—	15BB	14412	45.00	60.00	10.00	—	15BB
14838	44.45	76.20	6.35	—	14B.	—	44.50	73.00	12.70	—	12B.	12379	45.00	60.00	12.00	—	15BB
18561	44.45	76.20	9.53	—	113	22081	44.85	61.12	9.53	—	15BB	22091	45.00	60.00	12.00	—	15BA
22070	44.45	76.20	9.53	—	15BB	22080	44.85	61.12	9.53	—	12BA	12379	45.00	60.00	12.00	—	15B.
17131	44.45	76.20	12.70	—	15BB	22084	44.85	61.12	11.91	—	15BB	22092	45.00	61.00	9.00	—	15B.
22071	44.45	76.20	12.70	—	15BB	22083	44.85	61.12	11.91	—	15BA	16735	45.00	61.20	12.00	—	12BB
17131	44.45	76.20	12.70	—	15B.	22082	44.85	61.12	11.91	—	15B.	12039	45.00	62.00	7.00	—	15BA
18136	44.45	76.20	12.70	—	1550	15119	44.85	61.52	12.70	—	15BA	20239	45.00	62.00	7.00	—	14BB
17131	44.45	76.20	12.70	—	15B.	15119	44.85	61.52	12.70	—	ESPE	12039	45.00	62.00	7.00	—	15BB
18136	44.45	76.20	12.70	—	155B	15119	44.85	61.52	12.70	—	15B.	12039	45.00	62.00	7.00	—	15BA
18136	44.45	76.20	12.70	—	ESPE	15119	44.85	61.52	12.70	—	15C	20127	45.00	62.00	7.00	—	12BB
18136	44.45	76.20	12.70	—	ESPE	22085	44.85	65.48	9.53	—	15BA	12039	45.00	62.00	7.00	—	15BB
18560	44.45	76.20	17.46	—	12BC	15517	44.85	69.85	11.11	—	113	11129	45.00	62.00	8.00	—	15BB
22072	44.45	76.20	17.46	—	12B.	—	45.00	51.90	4.00	—	14BA	13211	45.00	62.00	8.00	—	14BB
18562	44.45	76.20	19.05	—	11BF	12162	45.00	52.00	4.00	—	14BA	11129	45.00	62.00	8.00	—	15BB
17055	44.45	77.79	12.70	—	15BB	12480	45.00	52.00	10.00	—	15B.	11129	45.00	62.00	8.00	—	15BA
17055	44.45	77.79	12.70	—	15BB	13148	45.00	54.00	7.50	—	ESPE	22094	45.00	62.00	8.00	—	15BA





# Retentores

Perfis - Ver Última Página



INCOVE VEDAÇÕES LTDA.

Cod.	Di	De	Ha1	Ha2	Mod	Cod.	Di	De	Ha1	Ha2	Mod	Cod.	Di	De	Ha1	Ha2	Mod
22093	45.00	62.00	8.00	—	I2BB	22105	45.00	65.00	12.00	—	I5BA	25372	45.00	80.00	10.00	—	I2BB
12900	45.00	62.00	9.00	—	I2BB	22104	45.00	65.00	12.00	—	I5B.	22131	45.00	80.00	10.00	—	I5B.
12900	45.00	62.00	9.00	—	I2BB	22107	45.00	65.00	12.00	—	I2B.	14425	45.00	80.00	12.00	—	I5BA
—	45.00	62.00	9.00	—	I2BB	11473	45.00	65.00	14.00	—	I2BA	14425	45.00	80.00	12.00	—	I5BB
20005	45.00	62.00	9.00	—	I4BB	14417	45.00	66.00	6.00	—	I5BB	14425	45.00	80.00	12.00	—	I5BA
13731	45.00	62.00	9.00	—	I5BB	14417	45.00	66.00	6.00	—	I5BB	14425	45.00	80.00	12.00	—	I5B.
12900	45.00	62.00	9.00	—	I2BB	22108	45.00	66.00	10.00	—	I5BB	22132	45.00	80.00	13.00	—	I5BB
22095	45.00	62.00	9.00	—	I2BB	22109	45.00	66.00	13.00	—	I5BA	22134	45.00	80.00	13.00	—	I5BA
14413	45.00	62.00	10.00	—	I5BB	14418	45.00	66.00	13.00	—	I5B.	11649	45.00	80.00	13.00	—	I2BB
14412	45.00	62.00	10.00	—	I5BA	14778	45.00	67.00	5.50	8.00	I13	11649	45.00	80.00	13.00	—	I2BA
14413	45.00	62.00	10.00	—	I5BB	14419	45.00	67.00	10.00	15.00	ESPE	11559	45.00	80.00	13.00	—	I5B.
13822	45.00	62.00	10.00	—	I2BB	12493	45.00	68.00	8.00	—	I5BB	22135	45.00	82.00	10.00	—	I5BB
14414	45.00	62.00	10.00	—	I2BB	12853	45.00	68.00	10.00	—	I5BB	22136	45.00	83.00	12.00	—	I5BB
14413	45.00	62.00	10.00	—	I5BA	11420	45.00	68.00	10.00	—	I2BA	14426	45.00	83.00	12.00	—	I5B.
14413	45.00	62.00	10.00	—	I5BB	11498	45.00	68.00	12.00	—	I5BB	13849	45.00	85.00	10.00	—	I5BB
14413	45.00	62.00	10.00	—	I5BB	11498	45.00	68.00	12.00	—	I5BA	22137	45.00	85.00	10.00	—	I5BA
14413	45.00	62.00	10.00	—	I5B.	22111	45.00	68.00	12.00	—	I5B.	22138	45.00	85.00	12.00	—	I5BA
13822	45.00	62.00	10.00	—	I2BB	22110	45.00	68.00	12.00	—	I2BA	16959	45.00	85.00	12.00	—	I2BB
13822	45.00	62.00	10.00	—	I2BB	20047	45.00	70.00	10.00	—	I5B.	14427	45.00	85.00	13.00	—	I5B.
13822	45.00	62.00	10.00	—	I2B.	22114	45.00	70.00	10.00	—	I5B.	14427	45.00	85.00	13.00	—	I5BA
14414	45.00	62.00	10.00	—	I2BB	22115	45.00	70.00	11.00	—	I2BA	22139	45.00	85.00	13.00	—	I5B.
13822	45.00	62.00	10.00	—	I2BB	14420	45.00	70.00	12.00	—	I5BB	14427	45.00	85.00	13.00	—	I5C
14413	45.00	62.00	10.00	—	I5BB	14420	45.00	70.00	12.00	—	I5BA	14427	45.00	85.00	13.00	—	I5BA
14413	45.00	62.00	10.00	—	I5B.	14420	45.00	70.00	12.00	—	I5B.	13982	45.00	90.00	6.00	—	I4C
13822	45.00	62.00	10.00	—	I2BB	20292	45.00	70.00	14.00	—	I5BB	22140	45.00	90.00	8.00	—	I5BB
22097	45.00	62.00	12.00	—	I5BB	20292	45.00	70.00	14.00	—	I5BB	17632	45.00	90.00	8.00	—	I814
13592	45.00	62.00	12.00	—	I2BB	22116	45.00	70.00	14.00	—	I5B.	20183	45.00	90.00	10.00	—	I5BB
22097	45.00	62.00	12.00	—	I5BB	11789	45.00	72.00	7.00	—	I2BB	13800	45.00	100.00	10.00	—	I2BB
13592	45.00	62.00	12.00	—	I2BB	22117	45.00	72.00	7.00	—	I5BA	22430	45.00	104.00	8.00	—	I2BB
22096	45.00	62.00	12.00	—	I2B.	22119	45.00	72.00	8.00	—	I5BB	11817	45.00	175.50	55.00	—	TDUO
13592	45.00	62.00	12.00	—	I2BB	22118	45.00	72.00	8.00	—	I2BB	15828	45.24	68.26	12.70	—	I80C
22098	45.00	62.00	13.00	—	I5BB	14381	45.00	72.00	9.00	—	I5BB	15828	45.24	68.26	12.70	—	I80B
17197	45.00	62.00	13.00	—	I5BA	22120	45.00	72.00	9.00	—	I2BB	17677	45.24	69.06	12.70	—	I13
11190	45.00	63.00	9.50	—	I5BB	14381	45.00	72.00	9.50	—	I5BB	15917	45.24	69.85	12.70	—	I5BA
16851	45.00	63.50	8.00	—	I5BB	14381	45.00	72.00	10.00	—	I5BA	22141	45.24	69.85	12.70	—	I5BB
12557	45.00	63.70	9.50	—	I5BB	14381	45.00	72.00	10.00	—	I5BA	22142	45.40	62.30	8.20	—	I2BA
12100	45.00	63.80	12.70	—	I5BA	14381	45.00	72.00	10.00	—	I5BB	—	45.60	48.75	3.20	—	I4BA
25433	45.00	63.95	9.00	—	I2BB	14381	45.00	72.00	10.00	—	I5BA	22143	46.00	55.00	10.00	—	I5BB
13146	45.00	63.95	9.00	—	I5BB	14381	45.00	72.00	10.00	—	I5B.	—	46.00	56.00	4.00	—	I2BB
22100	45.00	64.00	9.00	—	I5BB	22121	45.00	72.00	10.00	—	I2BB	16812	46.00	57.00	6.35	—	I5B.
16732	45.00	64.00	9.00	—	I2BB	14381	45.00	72.00	10.00	—	I5BB	22144	46.00	60.00	7.00	—	I5BB
13147	45.00	64.00	9.00	—	I13	14421	45.00	72.00	12.00	—	I5BB	13026	46.00	60.00	8.00	—	I5BB
13098	45.00	64.50	9.00	—	I4BB	22122	45.00	72.00	12.00	—	I5BB	13145	46.00	62.00	7.00	—	I2B
22209	45.00	65.00	7.00	—	I2BB	14421	45.00	72.00	12.00	—	I5BA	13145	46.00	62.00	7.00	—	I5B.
.....	45.00	65.00	8.00	—	I2BB	14421	45.00	72.00	12.00	—	I5B.	13145	46.00	62.00	7.00	—	I5BB
14415	45.00	65.00	8.00	—	I5BB	16446	45.00	72.00	12.00	—	I2BB	13145	46.00	62.00	7.00	—	I5BA
14415	45.00	65.00	8.00	—	I5BB	22123	45.00	72.00	12.00	—	I2BA	22146	46.00	62.00	7.00	—	I5B.
14415	45.00	65.00	8.00	—	I5BA	13527	45.00	72.00	15.00	—	I5BA	13145	46.00	62.00	7.00	—	I5B.
11275	45.00	65.00	8.00	—	I2BB	12718	45.00	72.20	9.00	—	I2BA	22147	46.00	62.00	12.00	—	I5B.
14415	45.00	65.00	8.00	—	I5BB	12718	45.00	72.20	9.00	—	I2BA	.....	46.00	62.30	9.00	—	I4BB
14415	45.00	65.00	8.00	—	I5BB	11624	45.00	72.50	13.00	—	I5BB	16990	46.00	62.30	9.00	—	I4BB
11275	45.00	65.00	8.00	—	I2BB	11896	45.00	73.10	13.00	—	I2BA	14428	46.00	64.00	8.00	—	I5BB
22102	45.00	65.00	9.00	—	I2BB	16574	45.00	73.20	12.70	—	I2B.	14428	46.00	64.00	8.00	—	I5BB
11516	45.00	65.00	9.00	—	I2BA	14423	45.00	74.50	10.00	15.00	ESPE	22148	46.00	65.00	10.00	—	I5B.
11412	45.00	65.00	10.00	—	I2BB	22124	45.00	74.50	12.00	—	I2BB	13174	46.00	65.50	7.00	—	I2BB
14416	45.00	65.00	10.00	—	I5BA	16995	45.00	75.00	8.00	—	I2BB	13639	46.00	65.50	7.00	—	I2BB
14416	45.00	65.00	10.00	—	I5B	16995	45.00	75.00	8.00	—	I2BB	13174	46.00	65.50	8.50	7.00	I2BA
14416	45.00	65.00	10.00	—	I5BB	22125	45.00	75.00	8.00	—	I2BB	13060	46.00	65.50	9.00	13.00	I2BB
14416	45.00	65.00	10.00	—	I5BB	22126	45.00	75.00	10.00	—	I5BB	13060	46.00	65.50	9.00	—	I2BB
14416	45.00	65.00	10.00	—	I5BB	12626	45.00	75.00	12.00	—	I5BB	14429	46.00	68.00	12.00	—	I5BB
14416	45.00	65.00	10.00	—	I5B.	22127	45.00	75.00	12.00	—	I5BA	22149	46.00	68.00	12.00	—	I5BA
11412	45.00	65.00	10.00	—	I2BB	14424	45.00	75.00	13.00	—	I5BA	14429	46.00	68.00	12.00	—	I5B.
11138	45.00	65.00	10.00	—	I7B.	22128	45.00	77.00	7.00	—	I5BB	22150	46.00	68.00	12.00	—	I2BB
14416	45.00	65.00	10.00	—	I5BA	22129	45.00	78.00	13.00	—	I5B.	22539	46.00	69.85	11.11	—	I5BA
14416	45.00	65.00	10.00	—	I5BA	16641	45.00	80.00	6.00	—	I4BA	13522	46.00	70.00	12.00	—	I2BB
17975	45.00	65.00	12.00	16.00	I5ES	22130	45.00	80.00	8.00	—	I5BB	22151	46.00	70.00	13.00	—	I5B.
22106	45.00	65.00	12.00	—	I5BB	13018	45.00	80.00	10.00	—	I5BB	20173	46.00	75.00	10.00	—	I5BB





# Retentores

Perfis - Ver Última Página



INCOVE VEDAÇÕES LTDA.

Cod.	Di	De	Ha1	Ha2	Mod	Cod.	Di	De	Ha1	Ha2	Mod	Cod.	Di	De	Ha1	Ha2	Mod
20173	46.00	75.00	10.00	—	15BB	22170	46.04	73.03	9.53	—	15BA	14431	47.00	65.00	14.00	—	15B.
13028	46.00	76.00	9.00	—	15BB	22171	46.04	73.03	11.91	—	15BB	14431	47.00	65.00	14.00	—	15B.
12575	46.00	76.00	10.00	—	15BA	17276	46.04	73.03	11.91	—	15B.	13762	47.00	67.00	7.00	—	15BA
19978	46.00	76.20	9.53	12.70	ESPE	17656	46.04	73.03	12.70	—	113	12383	47.00	68.00	10.00	—	12BB
20083	46.00	80.00	6.00	—	14BB	17651	46.04	73.42	12.70	—	15B.	12285	47.00	68.00	10.00	—	12BB
16934	46.00	80.00	10.00	—	15BB	22172	46.04	73.42	12.70	—	15BB	12285	47.00	68.00	10.00	—	12BB
22152	46.00	80.00	10.00	—	15B.	15272	46.04	74.61	4.76	—	F	12912	47.00	70.00	6.00	7.50	14BB
22153	46.00	80.00	10.00	—	12BA	15672	46.04	74.61	7.94	—	F	22190	47.00	70.00	12.00	—	15B.
22154	46.00	80.00	12.00	—	15B.	15121	46.04	75.41	6.35	—	14BA	22191	47.00	72.00	10.00	—	15B.
19940	46.04	53.98	5.60	—	14BA	15121	46.04	75.41	6.35	—	113	25385	47.00	72.00	12.00	—	17BB
16122	46.04	57.15	6.35	—	15B.	22174	46.04	76.20	11.11	—	15BB	11286	47.00	75.00	13.00	—	15B.
18182	46.04	60.33	6.35	—	14B.	22173	46.04	76.20	11.11	—	15BA	22192	47.00	80.00	8.00	—	15BB
20077	46.04	60.33	7.94	—	15BA	15677	46.04	76.20	11.91	—	15B.	13929	47.00	82.00	10.00	—	15BB
18568	46.04	60.33	9.53	—	113	17544	46.04	76.99	20.64	—	113	20211	47.00	85.00	12.00	—	15BA
17969	46.04	61.91	9.53	—	14	19043	46.04	77.79	11.11	—	15B.	11949	47.50	69.50	11.00	—	14BA
17969	46.04	61.91	9.53	—	15B.	22175	46.04	77.79	11.11	—	15BB	11949	47.50	69.50	11.00	—	14BA
18234	46.04	63.50	3.18	—	F	22176	46.04	79.38	11.11	—	15BB	16115	47.50	73.02	6.74	—	15BB
15682	46.04	63.50	6.35	—	113	18158	46.04	80.17	11.11	—	113	22193	47.50	90.00	8.00	—	12BB
22156	46.04	63.50	7.94	—	15B.	15465	46.04	80.96	8.73	—	F	16737	47.60	56.70	9.40	—	15BA
16747	46.04	63.50	7.94	—	15BB	22177	46.04	80.96	11.11	—	15BB	—	47.60	57.15	5.00	—	15BA
19037	46.04	63.50	11.11	—	15B.	15835	46.04	80.96	11.11	—	15B.	12247	47.60	63.50	11.00	—	12BA
22158	46.04	63.50	11.11	—	15BB	22178	46.04	80.96	12.70	—	15B.	16875	47.60	68.25	14.00	—	ESPE
14848	46.04	65.09	11.11	—	ESPE	15685	46.04	80.96	21.43	—	11BF	16389	47.60	69.85	11.91	—	15BA
14848	46.04	65.09	11.11	—	ESPE	22179	46.04	82.55	12.70	—	15BB	15623	47.60	70.60	6.35	—	15BB
22159	46.04	65.48	7.14	—	15BB	18257	46.04	82.55	12.70	—	15B.	16208	47.60	70.60	13.50	—	12BA
13479	46.04	66.68	6.35	—	15BA	17360	46.04	98.43	11.11	—	1814	16022	47.60	73.00	9.50	—	15BA
13479	46.04	66.68	6.35	—	15BA	19927	46.04	104.80	15.88	—	ESPE	16022	47.60	73.00	9.50	—	15B.
19976	46.04	66.68	6.35	—	14C	18570	46.04	108.00	19.05	—	112	16417	47.60	73.00	9.50	—	12B.
13479	46.04	66.68	6.35	—	15BB	15617	46.04	120.70	11.91	—	155	—	47.60	74.00	14.00	—	12BB
19976	46.04	66.68	6.35	—	14C	17625	46.04	122.20	14.29	—	155	15258	47.60	75.30	6.40	—	14BA
22160	46.04	66.68	12.70	—	15BB	11338	46.10	62.20	7.90	—	15BA	.....	47.60	80.00	13.00	—	12BA
17047	46.04	66.68	12.70	—	15B.	11338	46.10	62.20	7.90	—	15B.	....	47.60	80.25	6.50	16.50	ESPE
22161	46.04	66.68	12.70	—	12BA	11337	46.10	70.90	7.90	—	15B.	15790	47.60	82.80	11.00	—	15B.
15745	46.04	66.68	12.70	—	17BA	12380	46.20	73.15	9.50	—	15BA	15790	47.60	82.80	11.00	—	15C
15745	46.04	66.68	12.70	—	17B.	12380	46.20	73.15	9.50	—	15BA	13341	47.62	66.73	12.70	—	15B.
15745	46.04	66.68	12.70	—	17BB	12988	46.20	80.00	10.00	—	12B.	13341	47.62	66.73	12.70	—	15BB
17152	46.04	66.68	19.84	—	11BF	12997	46.20	80.00	10.00	—	15BB	12482	47.63	57.15	4.76	—	15BA
17152	46.04	66.68	19.84	—	11FC	.....	46.30	66.60	6.70	—	ESPE	15506	47.63	58.74	7.94	—	F
22162	46.04	67.47	9.53	—	15BB	16055	46.50	65.00	8.00	—	15BB	19018	47.63	58.74	9.53	—	15BB
18095	46.04	68.26	12.70	—	15BB	22180	46.50	70.50	7.00	—	15BB	17401	47.63	60.33	6.35	—	F
18095	46.04	68.26	12.70	—	15BA	16345	46.50	71.00	18.00	—	15BB	17886	47.63	61.12	6.35	—	14
17394	46.04	69.06	9.53	—	14B.	13335	46.60	69.90	11.10	—	15BA	13031	47.63	61.12	6.35	—	15BA
18569	46.04	69.06	11.91	—	15B.	16036	46.62	62.20	8.00	—	15BA	17738	47.63	61.91	4.76	—	ESPE
22163	46.04	69.06	11.91	—	15BB	CORTI	46.83	62.31	7.94	—	CORT	22195	47.63	61.91	5.95	—	15BA
18068	46.04	69.85	6.35	—	14B.	22181	46.83	66.68	12.70	—	15B.	17970	47.63	61.91	7.94	—	15BB
22164	46.04	69.85	6.35	—	15BB	17635	46.83	68.26	12.70	—	15B.	17970	47.63	61.91	7.94	—	15BA
15679	46.04	69.85	6.35	—	15BA	22182	46.83	68.26	12.70	—	15BB	17970	47.63	61.91	7.94	—	15BB
15679	46.04	69.85	6.35	—	15B.	22183	46.83	80.96	11.11	—	15BB	14873	47.63	62.71	11.11	—	12BB
15711	46.04	69.85	7.94	—	F	15835	46.83	80.96	11.11	—	15B.	14873	47.63	62.71	11.11	—	12BA
22165	46.04	69.85	11.11	—	15BA	13792	46.86	63.50	12.70	—	15BB	22196	47.63	62.71	11.11	—	12BA
22167	46.04	69.85	12.30	—	15BB	11814	47.00	57.00	14.00	—	ESPE	18233	47.63	63.50	3.18	—	F
22168	46.04	69.85	12.30	—	12BB	13661	47.00	58.00	4.80	—	14BA	22197	47.63	63.50	7.94	—	15BB
17680	46.04	69.85	12.70	—	113	16005	47.00	58.00	5.00	—	14BB	18310	47.63	63.50	7.94	—	15B.
17805	46.04	69.85	12.70	—	14	22184	47.00	58.00	7.00	—	12BB	11329	47.63	63.50	9.53	—	15BA
17099	46.04	69.85	12.70	—	15B.	RU30	47.00	58.00	7.00	—	12	17664	47.63	63.50	11.11	—	F
13358	46.04	69.85	12.70	—	12BB	12339	47.00	58.30	7.00	—	12BB	22198	47.63	63.50	11.11	—	15B.
13358	46.04	69.85	12.70	—	12BB	11698	47.00	60.00	7.00	—	12BB	22199	47.63	63.50	11.11	—	12BB
17475	46.04	70.64	12.70	—	15BB	22184	47.00	60.00	11.00	—	12BA	12247	47.63	63.50	11.11	—	12BA
17475	46.04	70.64	12.70	—	15BB	22185	47.00	62.00	6.00	—	15BB	18572	47.63	63.50	12.70	—	15BB
22169	46.04	72.23	9.53	—	15BB	22187	47.00	62.00	8.00	—	15BA	22200	47.63	63.50	12.70	—	15BB
15019	46.04	72.23	9.53	—	14BB	22186	47.00	62.00	8.00	—	15BB	13453	47.63	63.50	12.70	—	13C
22169	46.04	72.23	9.53	—	15BB	20412	47.00	62.00	9.00	—	15BB	15998	47.63	63.50	19.05	—	11BF
15019	46.04	72.23	9.53	—	14BA	22188	47.00	62.00	10.00	—	15BB	18304	47.63	63.50	25.40	—	1553
15019	46.04	72.23	9.53	—	14C	22189	47.00	62.00	12.00	—	15B.	14766	47.63	64.29	6.35	—	15BB
18029	46.04	72.23	14.29	—	14BA	.....	47.00	65.00	7.00	—	12BA	15951	47.63	65.09	7.94	—	15BB
18029	46.04	72.23	14.29	—	14BA	13144	47.00	65.00	9.00	—	1550	15951	47.63	65.09	7.94	—	15BB
15350	46.04	73.03	9.53	—	14C	13144	47.00	65.00	9.00	—	1550	15951	47.63	65.09	7.94	—	15BB



# Retentores

Perfis - Ver Última Página



INCOVE VEDAÇÕES LTDA.

Cod.	Di	De	Ha1	Ha2	Mod	Cod.	Di	De	Ha1	Ha2	Mod	Cod.	Di	De	Ha1	Ha2	Mod
15951	47.63	65.09	7.94	—	I5B.	20015	47.63	70.88	6.00	—	I5BA	11510	47.63	82.55	12.70	—	I2BB
18247	47.63	65.09	7.94	—	I2BB	19360	47.63	71.44	12.70	—	I550	12382	47.63	82.55	12.70	—	I5B.
15597	47.63	65.09	9.53	—	F	18236	47.63	72.23	9.53	—	I5B.	12382	47.63	82.55	12.70	—	I5C
14711	47.63	65.09	9.53	—	I5BB	18060	47.63	72.23	9.53	—	I13	14038	47.63	82.55	12.70	14.29	I21B
22202	47.63	65.09	13.49	—	I5BB	18236	47.63	72.23	9.53	—	I5C	14814	47.63	82.55	15.88	—	I7BB
20001	47.63	65.23	7.94	—	I5BB	17549	47.63	72.23	19.05	—	I1BF	15598	47.63	85.73	9.13	—	I13
13342	47.63	66.67	12.70	—	I2BB	18575	47.63	73.03	6.35	—	I4BA	22232	47.63	85.73	11.91	—	I5BB
22203	47.63	66.68	7.94	—	I2BA	22219	47.63	73.03	6.75	—	I5B.	18576	47.63	85.73	11.91	—	I5BA
15791	47.63	66.68	9.52	—	I5BA	17132	47.63	73.03	7.94	—	I5BA	12607	47.63	88.11	11.91	—	I2BB
15791	47.63	66.68	9.53	—	I5BB	13711	47.63	73.03	9.53	—	I7BB	18064	47.63	88.90	9.53	—	I13
15791	47.63	66.68	9.53	—	I5BA	13221	47.63	73.03	9.53	—	I5C	17300	47.63	88.90	11.11	—	F
11966	47.63	66.68	9.53	—	I4BA	22220	47.63	73.03	11.11	—	I5B.	15433	47.63	88.90	20.64	—	ESPE
22204	47.63	66.68	9.53	—	I5BB	22221	47.63	73.03	11.91	—	I5B.	15433	47.63	88.90	20.64	—	I1
11449	47.63	66.68	9.53	—	I2BB	15070	47.63	73.03	12.00	—	I5B.	15620	47.63	89.69	9.53	—	I13
15791	47.63	66.68	9.53	—	I5BA	15070	47.63	73.03	12.00	—	I5B.	15424	47.63	90.88	19.84	—	ESPE
15791	47.63	66.68	9.53	—	I5BB	15070	47.63	73.03	12.00	—	I5C	17547	47.63	95.25	9.53	—	I13
12540	47.63	66.68	9.53	—	I5B.	22222	47.63	73.03	12.70	—	I5B.	17547	47.63	95.25	9.53	—	I4BA
22207	47.63	66.68	12.70	—	I5BB	15883	47.63	73.03	12.70	—	ESPE	15717	47.63	95.25	17.46	—	I1BF
22206	47.63	66.68	12.70	—	I5BA	17135	47.63	73.03	15.88	—	I2	15717	47.63	95.25	17.46	—	I1FC
13342	47.63	66.68	12.70	—	I2BA	13840	47.63	73.03	17.46	—	I12B	15447	47.63	102.00	25.40	—	I1BF
13342	47.63	66.68	12.70	—	I2BA	17930	47.63	73.03	22.23	—	I7B.	15414	47.63	111.10	15.88	—	I55
13342	47.63	66.68	12.70	—	I5C	17651	47.63	73.42	12.70	—	I5B.	18241	47.63	114.30	12.70	—	I55
17548	47.63	66.68	17.46	—	I1FB	15073	47.63	73.42	16.67	—	I1BF	17294	47.64	130.20	38.89	—	I55
17548	47.63	66.68	17.46	—	I1BF	22223	47.63	75.41	6.35	—	I5BB	18941	47.64	139.70	15.88	—	I55
12381	47.63	66.68	19.05	—	I1BF	15330	47.63	75.41	6.35	—	I4	RU28	47.69	90.80	8.00	—	I2
12381	47.63	66.68	19.05	—	I1FC	15258	47.63	75.41	6.35	—	I13	12321	47.70	73.00	9.50	12.60	I2BA
13341	47.63	66.73	12.70	—	I5B.	15918	47.63	76.20	9.53	—	I4BA	—	47.80	65.00	11.70	—	I2BA
18021	47.63	68.26	12.70	—	I5BA	22224	47.63	76.20	9.53	—	I5BA	25430	48.00	56.00	6.00	—	I2BB
22208	47.63	68.26	12.70	—	I5B.	22225	47.63	76.20	9.53	—	I5BA	22233	48.00	58.00	7.00	—	I5BB
15036	47.63	68.26	14.29	—	ESPE	15918	47.63	76.20	9.53	—	I4C	16360	48.00	58.00	10.00	—	I5B.
18172	47.63	68.26	19.05	—	ESPE	15369	47.63	76.20	11.11	—	I13	14432	48.00	61.00	7.00	—	I5BA
19925	47.63	69.06	8.33	—	ESPE	15182	47.63	76.20	12.70	—	I5C	22420	48.00	62.00	5.00	—	I5BB
22210	47.63	69.06	9.92	—	I5BA	15182	47.63	76.20	12.70	—	I5BB	22234	48.00	62.00	7.00	—	I2BB
18918	47.63	69.06	10.32	—	I5B.	15182	47.63	76.20	12.70	—	I5BB	22235	48.00	62.00	8.00	—	I5BB
15543	47.63	69.06	11.91	—	I13	15182	47.63	76.20	12.70	—	I5BA	16118	48.00	62.00	8.00	—	I5BB
22211	47.63	69.06	11.91	—	I5B.	15182	47.63	76.20	12.70	—	I5B.	16118	48.00	62.00	8.00	—	I2BB
17538	47.63	69.45	19.05	—	CORT	19360	47.63	76.20	12.70	—	I55B	16118	48.00	62.00	8.00	—	I2BB
22212	47.63	69.85	6.35	—	I5BB	15182	47.63	76.20	12.70	—	I5C	22237	48.00	62.00	10.00	—	I5BB
11150	47.63	69.85	6.35	—	I5B.	17525	47.63	76.20	16.67	—	I2	22236	48.00	62.00	10.00	—	I5BA
11701	47.63	69.85	7.94	—	I2BB	22226	47.63	76.20	19.05	—	I5B.	14433	48.00	62.00	10.00	—	I5BA
13419	47.63	69.85	9.52	—	I5BB	19040	47.63	76.20	19.05	—	ESPE	13079	48.00	63.00	11.00	—	I2BB
13419	47.63	69.85	9.52	—	I5BB	18004	47.63	76.20	19.05	—	I1FC	22238	48.00	64.00	10.00	—	I5BB
13419	47.63	69.85	9.52	—	I5BB	15684	47.63	76.20	22.26	—	ESPE	18247	48.00	65.00	7.00	—	I2BB
22213	47.63	69.85	9.53	—	I5B.	15344	47.63	77.79	7.94	—	F	22239	48.00	65.00	7.00	—	I2BB
15649	47.63	69.85	12.70	—	I5B	15987	47.63	77.79	11.11	—	I13	22240	48.00	65.00	7.00	—	I2BA
15649	47.63	69.85	12.70	—	I5B.	22227	47.63	77.79	12.70	—	I5BB	16997	48.00	65.00	8.00	—	I5BB
15649	47.63	69.85	12.70	—	I5BB	15440	47.63	77.79	12.70	—	I5BA	16997	48.00	65.00	8.00	—	I5BA
22214	47.63	69.85	12.70	—	I5B.	18064	47.63	78.58	9.53	—	I13	14430	48.00	65.00	10.00	—	I5B.
22215	47.63	69.85	12.70	—	I2B.	15424	47.63	78.98	19.84	—	I1BF	14430	48.00	65.00	10.00	—	I5BB
15649	47.63	69.85	12.70	—	I5C	15424	47.63	78.98	19.84	—	I1FC	14430	48.00	65.00	10.00	—	I5BB
22216	47.63	69.85	15.88	—	I5BB	12952	47.63	79.20	12.70	—	I4JM	22241	48.00	65.00	10.00	—	I5B.
15326	47.63	70.25	16.67	—	I3BB	15948	47.63	79.25	10.00	—	I5BB	13611	48.00	65.00	10.00	—	I2BB
15623	47.63	70.64	6.35	—	I5BB	15948	47.63	79.25	10.00	—	I5BB	22242	48.00	65.00	10.00	—	I2BB
22217	47.63	70.64	6.35	—	I5BB	15948	47.63	79.25	10.00	—	I5B.	13611	48.00	65.00	10.00	—	I2BA
15623	47.63	70.64	6.35	—	I4C	22228	47.63	79.38	9.53	—	I2BB	14430	48.00	65.00	10.00	—	I5BA
15623	47.63	70.64	6.35	—	I4BA	18174	47.63	79.38	12.70	—	I13	13611	48.00	65.00	10.00	—	I2BB
22372	47.63	70.64	10.01	—	I5BA	15124	47.63	80.17	6.35	—	I13	12698	48.00	65.00	12.00	—	I5B
15288	47.63	70.64	13.49	—	I5BA	19046	47.63	80.17	11.11	—	I5BB	13049	48.00	65.00	12.00	—	I2B.
15288	47.63	70.64	13.49	—	I5BA	19928	47.63	80.17	12.70	—	I5B.	22244	48.00	65.00	12.00	—	I5BA
15288	47.63	70.64	13.49	—	I5BA	18177	47.63	80.17	13.49	—	I13	12698	48.00	65.00	12.00	—	I5B.
15288	47.63	70.64	13.49	—	I5B.	22229	47.63	80.96	11.11	—	I5B.	22243	48.00	65.00	12.00	—	I2B.
13274	47.63	70.64	14.50	—	I2B.	17072	47.63	80.96	11.11	—	I5B.	14431	48.00	65.00	14.00	—	I5BB
13274	47.63	70.64	14.50	—	ESPE	22230	47.63	80.96	12.70	—	I5B.	22245	48.00	65.00	14.00	—	I5BA
15113	47.63	70.64	14.50	—	I3C	17098	47.63	80.96	17.86	—	I2	22246	48.00	66.00	10.00	—	I5BB
13274	47.63	70.64	15.88	—	I2BA	15790	47.63	82.55	11.91	—	I5B.	13134	48.00	66.00	12.00	—	I5BB
22218	47.63	70.64	16.67	—	I5BB	12382	47.63	82.55	12.70	—	I5BB	22247	48.00	66.00	12.00	—	I5BB
15113	47.63	70.64	17.46	—	I3B.	22231	47.63	82.55	12.70	—	I5B.	12474	48.00	67.00	9.50	—	I5B.



# Retenfores

Perfis - Ver Última Página



INCOVE VEDAÇÕES LTDA.

Cod.	Di	De	Ha1	Ha2	Mod	Cod.	Di	De	Ha1	Ha2	Mod	Cod.	Di	De	Ha1	Ha2	Mod
16888	48.00	68.00	7.00	—	15BB	12176	49.00	55.00	4.80	—	14BA	15950	49.21	68.26	12.70	—	15BA
22248	48.00	68.00	10.00	—	15BB	11496	49.00	61.50	6.20	—	15BB	15950	49.21	68.26	12.70	—	15B.
14434	48.00	68.00	10.00	—	15B.	22271	49.00	62.00	7.50	—	15BB	19930	49.21	68.26	17.46	—	CORT
12383	48.00	68.00	10.00	—	12BB	13133	49.00	65.00	8.00	—	12BB	22296	49.21	69.06	11.91	—	15BB
22249	48.00	68.00	12.00	—	15B.	13133	49.00	65.00	8.00	—	12BB	17468	49.21	69.06	11.91	—	15B.
22250	48.00	69.00	12.00	—	15BA	13239	49.00	65.00	10.00	—	12BA	22297	49.21	69.45	12.70	—	15B.
16027	48.00	70.00	8.00	—	15BB	22272	49.00	65.00	10.00	—	12BA	18050	49.21	69.85	9.53	—	F
16027	48.00	70.00	8.00	—	15BB	13521	49.00	65.00	10.00	—	15BA	17086	49.21	69.85	9.53	—	15BA
22251	48.00	70.00	10.00	—	15BB	—	49.00	67.00	7.50	—	12BB	17086	49.21	69.85	9.53	—	15BB
16485	48.00	70.00	12.00	—	15BA	16966	49.00	67.00	8.00	—	12BA	22300	49.21	69.85	9.53	—	15BA
16485	48.00	70.00	12.00	—	15B.	22273	49.00	67.00	8.50	—	15BB	22298	49.21	69.85	9.53	—	15B.
22252	48.00	70.00	12.00	—	12BB	22274	49.00	68.00	10.00	—	15B.	17086	49.21	69.85	9.53	—	15C
13891	48.00	70.00	13.00	—	12BB	22275	49.00	68.00	12.00	—	15BA	11107	49.21	70.00	9.00	—	12BB
22254	48.00	70.00	15.00	—	15B.	22276	49.00	68.00	12.00	—	12BA	13827	49.21	70.60	7.40	—	ESPE
17758	48.00	72.00	5.00	—	113	22277	49.00	68.00	14.00	—	15BA	19047	49.21	70.64	11.11	—	15BB
22255	48.00	72.00	5.00	—	15BB	22278	49.00	70.00	9.00	—	15BB	17755	49.21	71.44	12.70	—	15B.
14436	48.00	72.00	7.00	—	12BB	22279	49.00	70.00	11.00	—	15BB	22301	49.21	71.44	12.70	—	15BB
14436	48.00	72.00	7.00	9.00	12BB	14453	49.00	75.00	11.00	—	15BB	17088	49.21	71.83	9.53	—	15B.
14436	48.00	72.00	7.00	—	12BB	22280	49.00	75.00	11.00	—	15BB	17088	49.21	71.83	9.53	—	15C
22257	48.00	72.00	7.00	—	15BB	22281	49.00	75.00	13.00	—	15BB	18578	49.21	73.03	6.35	—	14
11049	48.00	72.00	7.00	—	15BA	22282	49.00	76.00	10.00	—	15B.	15359	49.21	73.03	9.52	—	F
14436	48.00	72.00	7.00	—	12BA	11955	49.00	76.20	12.70	—	12BA	22302	49.21	73.03	11.91	—	15BA
11465	48.00	72.00	8.00	—	15BB	16099	49.00	79.00	12.00	—	15BB	17067	49.21	73.03	11.91	—	15BA
11465	48.00	72.00	8.00	—	15BA	12849	49.00	90.00	10.00	—	12BA	17067	49.21	73.03	11.91	—	15C
12792	48.00	72.00	10.00	—	12BB	13133	49.20	65.00	8.00	—	15BB	12310	49.21	73.03	15.88	—	17BB
18236	48.00	72.00	10.00	—	15BB	16382	49.20	73.03	7.95	—	15B.	18579	49.21	73.03	17.46	—	112
22260	48.00	72.00	10.00	—	15BB	15116	49.21	59.53	9.53	—	F	15854	49.21	73.03	19.05	—	11BF
22259	48.00	72.00	10.00	—	15B.	18347	49.21	61.52	11.91	—	15BB	14052	49.21	73.03	19.05	—	1121
22261	48.00	72.00	10.00	—	12BB	14523	49.21	61.91	6.35	—	14B.	15854	49.21	73.03	19.05	—	11FC
12792	48.00	72.00	10.00	—	15BB	15972	49.21	63.50	6.35	—	14BB	18905	49.21	74.61	12.70	—	180
14670	48.00	72.00	12.00	—	15BB	13347	49.21	63.50	6.35	—	15BA	15624	49.21	75.41	6.35	—	14
14670	48.00	72.00	12.00	—	15BB	15972	49.21	63.50	6.35	—	14C	15492	49.21	76.20	7.94	—	15BB
22262	48.00	72.00	12.00	—	15BA	15972	49.21	63.50	6.35	—	ESPE	15492	49.21	76.20	7.94	—	15B.
14670	48.00	72.00	12.00	—	15B.	22284	49.21	63.50	7.14	—	15BB	15733	49.21	76.20	11.11	—	F
16833	48.00	72.00	12.00	—	12BB	22283	49.21	63.50	7.14	—	15BA	11493	49.21	76.20	11.91	—	15B.
14670	48.00	72.00	12.00	—	15BB	13827	49.21	63.50	7.40	—	ESPE	15067	49.21	76.20	12.70	—	15BB
22263	48.00	72.00	13.00	—	15B.	13348	49.21	63.50	7.94	—	15B.	15067	49.21	76.20	12.70	—	15B.
13680	48.00	74.00	48.50	—	ESPE	13454	49.21	63.50	9.53	—	15BA	22304	49.21	76.20	12.70	—	12BB
—	48.00	75.00	8.00	—	15BA	22285	49.21	63.50	9.53	—	15BB	22303	49.21	76.20	12.70	—	15B.
16436	48.00	75.00	13.00	—	15BB	22286	49.21	63.50	9.53	—	15BA	13287	49.21	76.20	12.70	—	12B.
11969	48.00	77.00	12.00	—	15BA	18577	49.21	63.50	12.70	—	15BB	15067	49.21	76.20	12.70	—	113
16404	48.00	78.00	12.00	—	12BA	14044	49.21	64.29	7.94	—	15BB	13287	49.21	76.20	12.70	—	12B.
22264	48.00	80.00	8.10	—	15B.	15722	49.21	65.09	7.94	—	CORT	15067	49.21	76.20	12.70	—	15C
13629	48.00	80.00	10.00	—	15BB	22287	49.21	65.09	7.94	—	15BA	15179	49.21	76.20	15.88	—	13C
13629	48.00	80.00	10.00	—	15B.	.....	49.21	65.09	8.33	—	15BB	13288	49.21	76.20	17.46	—	12BC
14439	48.00	80.00	12.00	—	15BA	22288	49.21	65.09	8.33	—	12BB	13288	49.21	76.20	17.46	—	12C
14439	48.00	80.00	12.00	—	15BA	13049	49.21	65.09	11.91	—	12B	18580	49.21	76.20	19.05	—	11BF
.....	48.00	80.00	13.00	—	ESPE	13049	49.21	65.09	11.91	—	12B.	17543	49.21	76.60	12.70	—	113
S2274	48.00	80.00	13.00	—	180B	15567	49.21	66.68	4.76	7.94	113	17285	49.21	77.79	12.70	—	15BB
16473	48.00	80.00	13.00	—	15BB	17795	49.21	66.68	6.35	—	14BB	15959	49.21	77.79	12.70	—	155B
22265	48.00	80.00	13.00	—	15B.	15112	49.21	66.68	6.35	—	F	22305	49.21	79.38	9.53	—	12BA
13134	48.00	82.00	13.00	—	ESPE	17795	49.21	66.68	6.35	—	14BB	17210	49.21	79.38	12.70	—	15BB
14440	48.00	86.00	12.00	—	15B.	22289	49.21	66.68	6.35	—	15BA	17210	49.21	79.38	12.70	—	15BB
14440	48.00	86.00	12.00	—	15C	17795	49.21	66.68	6.35	—	14BA	17210	49.21	79.38	12.70	—	15B.
12607	48.00	88.00	12.00	—	12BB	17795	49.21	66.68	6.35	—	ESPE	17784	49.21	79.38	12.70	—	12BA
22266	48.00	90.00	10.00	—	15BB	22290	49.21	66.68	9.13	—	15BA	15050	49.21	79.77	9.00	22.23	ESPE
22267	48.00	90.00	12.00	—	12BB	22291	49.21	66.68	9.13	—	15B.	15050	49.21	79.77	9.00	22.23	ESPE
22268	48.00	90.00	13.00	—	15B.	11906	49.21	66.68	11.11	—	12B.	22306	49.21	80.17	9.53	—	15BB
13620	48.00	92.00	12.00	—	15BA	22293	49.21	66.68	12.70	—	15B	15421	49.21	80.17	9.53	—	14
22269	48.00	100.00	8.00	—	15BB	22292	49.21	66.68	12.70	—	12B.	17571	49.21	80.96	6.35	—	14C
15945	48.42	64.29	6.35	—	15BB	17595	49.21	66.68	12.70	—	12B.	15148	49.21	80.96	11.11	—	15B.
17402	48.42	72.23	7.94	—	113	12738	49.21	66.80	9.00	—	15B.	15148	49.21	80.96	11.11	—	15C
18010	48.42	73.03	11.91	—	15B.	15273	49.21	68.26	6.35	—	F	12384	49.21	80.96	11.91	—	15B.
22270	48.42	73.03	11.91	—	15BB	17396	49.21	68.26	6.35	—	14BA	22307	49.21	80.96	11.91	—	15B.
15421	48.42	80.17	9.53	—	14	13377	49.21	68.26	11.91	—	12BA	12384	49.21	80.96	11.91	—	15C
15487	48.42	80.96	11.11	—	15BB	22295	49.21	68.26	12.70	—	15BA	15145	49.21	82.55	7.94	—	F
11154	48.50	70.80	16.00	—	19B.	15950	49.21	68.26	12.70	—	15B.	22308	49.21	82.55	9.53	—	12BB



# Retentores

Perfis - Ver Última Página



INCOVE VEDAÇÕES LTDA.

Cod.	Di	De	Ha1	Ha2	Mod	Cod.	Di	De	Ha1	Ha2	Mod	Cod.	Di	De	Ha1	Ha2	Mod
19048	49.21	82.55	11.11	—	15BB	14443	50.00	65.00	10.00	—	15BA	14449	50.00	72.00	12.00	—	15BB
22309	49.21	82.55	11.11	—	15B.	14443	50.00	65.00	10.00	—	15BA	14449	50.00	72.00	12.00	—	15BA
15051	49.21	82.55	22.23	—	ESPE	13239	50.00	65.00	10.00	—	12BB	14449	50.00	72.00	12.00	—	15B.
15051	49.21	82.55	22.23	—	ESPE	13239	50.00	65.00	10.00	—	12BA	14449	50.00	72.00	12.00	—	15B.
18573	49.21	84.93	11.91	—	15BA	13239	50.00	65.00	10.00	—	12BA	12209	50.00	72.00	12.00	—	12BB
15251	49.21	85.33	41.28	—	ESPE	14443	50.00	65.00	10.00	—	15BB	14449	50.00	72.00	12.00	—	15BB
15598	49.21	85.73	9.13	—	113	14710	50.00	65.00	12.00	—	12BA	22330	50.00	72.00	14.00	—	15BA
18581	49.21	88.90	6.35	—	14	14710	50.00	65.00	12.00	—	12BB	16881	50.00	73.00	11.00	—	15BB
18582	49.21	90.09	12.70	—	15BA	16884	50.00	66.00	8.00	—	12BB	14450	50.00	74.00	12.00	—	15BB
17116	49.21	92.08	9.53	—	113	13546	50.00	67.00	8.00	—	15BA	14450	50.00	74.00	12.00	—	15B.
18583	49.21	92.08	11.91	—	15B.	13428	50.00	67.00	9.00	—	15BB	20174	50.00	75.00	6.00	—	15BB
18584	49.21	92.08	17.46	—	112	15172	50.00	67.00	13.00	—	15B.	22331	50.00	75.00	9.00	—	15BB
14026	49.21	95.25	12.70	—	15B.	22319	50.00	68.00	7.00	—	15BB	22331	50.00	75.00	9.00	—	15BA
13856	49.21	100.00	11.11	—	15BA	16927	50.00	68.00	8.00	—	15BB	14452	50.00	75.00	10.00	—	15BB
22310	49.21	107.95	14.29	—	15B.	16927	50.00	68.00	8.00	—	15BA	14452	50.00	75.00	10.00	—	15BA
17057	49.21	108.00	14.29	—	15B.	16927	50.00	68.00	8.00	—	15BB	14453	50.00	75.00	12.00	—	15BB
17663	49.21	111.10	15.08	—	113	12254	50.00	68.00	8.50	—	14BB	14453	50.00	75.00	12.00	—	15BA
15423	49.21	111.10	16.27	—	155	12899	50.00	68.00	9.00	—	12BB	14453	50.00	75.00	12.00	—	15B.
15680	49.21	126.20	19.05	—	155	12899	50.00	68.00	9.00	—	12BB	14453	50.00	75.00	12.00	—	15B.
15366	49.21	131.80	25.40	—	155	14444	50.00	68.00	10.00	—	15BB	16219	50.00	75.00	12.00	—	12B.
17535	49.21	136.50	20.64	—	155	14444	50.00	68.00	10.00	—	15BB	12895	50.00	75.00	13.00	—	12BB
11411	49.22	70.80	8.14	—	15BB	14444	50.00	68.00	10.00	—	15BA	22332	50.00	78.00	8.00	—	15BB
16204	49.22	87.74	12.70	—	15BB	14444	50.00	68.00	10.00	—	15B.	16571	50.00	78.00	10.00	—	15BB
12631	49.50	66.50	13.00	—	15B.	22321	50.00	68.00	10.00	—	12BB	16769	50.00	79.40	9.50	—	12BB
22311	49.50	68.00	8.40	—	15BB	14444	50.00	68.00	10.00	—	15B	14454	50.00	80.00	6.40	—	15C
11783	49.70	76.20	12.00	—	15BA	22322	50.00	68.00	12.00	—	12BA	14454	50.00	80.00	6.40	—	14BA
12257	50.00	58.00	4.00	—	14BA	17214	50.00	68.00	12.00	—	15B.	14454	50.00	80.00	6.40	—	14BA
12164	50.00	58.00	4.00	—	14BA	13630	50.00	68.00	12.00	—	12BA	11610	50.00	80.00	8.00	—	15BB
22312	50.00	60.00	6.00	—	15BA	17214	50.00	68.00	12.00	—	15BA	12349	50.00	80.00	8.00	—	12BB
11351	50.00	60.00	7.00	—	15BB	17214	50.00	68.00	12.00	—	15C	12349	50.00	80.00	8.00	—	12BB
11351	50.00	60.00	7.00	—	15BA	12385	50.00	68.00	14.00	—	15BA	14455	50.00	80.00	10.00	—	15BB
12019	50.00	60.00	10.00	—	15BA	12385	50.00	68.00	14.00	—	15BA	14455	50.00	80.00	10.00	—	15BB
12755	50.00	60.00	12.00	—	15BB	14445	50.00	70.00	6.00	—	15BA	14455	50.00	80.00	10.00	—	15BA
12755	50.00	60.00	12.00	—	15BA	14445	50.00	70.00	6.00	—	15BA	14455	50.00	80.00	10.00	—	15B.
12165	50.00	62.00	4.00	—	14BA	14445	50.00	70.00	6.00	—	15B.	14455	50.00	80.00	10.00	—	15BB
12007	50.00	62.00	5.00	—	14BA	12957	50.00	70.00	8.00	—	15BB	12386	50.00	80.00	12.00	—	15B
16282	50.00	62.00	5.00	—	12BB	16295	50.00	70.00	8.00	—	12BB	14456	50.00	80.00	12.70	—	15B
14693	50.00	62.00	7.00	—	15BB	14446	50.00	70.00	10.00	—	15BB	14456	50.00	80.00	13.00	—	15BB
14693	50.00	62.00	7.00	—	15BA	14446	50.00	70.00	10.00	—	15BB	14456	50.00	80.00	13.00	—	15BA
14693	50.00	62.00	7.00	—	15B.	14446	50.00	70.00	10.00	—	15BA	16231	50.00	80.00	13.00	—	12B.
14693	50.00	62.00	7.00	—	15BB	11253	50.00	70.00	10.00	—	12BB	14456	50.00	80.00	13.00	—	15BB
11293	50.00	62.00	8.00	—	15BB	14446	50.00	70.00	10.00	—	15BB	11573	50.00	80.00	14.00	—	15JM
11293	50.00	62.00	8.00	—	15BA	14447	50.00	70.00	10.00	—	180B	12058	50.00	81.60	10.00	12.00	12BB
14441	50.00	62.00	10.00	—	15BA	13368	50.00	70.00	12.00	—	12BA	20319	50.00	85.00	10.00	—	15BB
14441	50.00	62.00	10.00	—	15BB	14741	50.00	70.00	12.00	—	15BB	22336	50.00	85.00	13.00	—	15B.
14441	50.00	62.00	10.00	—	15BA	14741	50.00	70.00	12.00	—	15B.	22335	50.00	85.00	13.00	—	12BB
14441	50.00	62.00	10.00	—	15B.	22326	50.00	70.00	12.00	—	12BB	12206	50.00	87.00	12.50	—	12BA
16342	50.00	62.00	10.00	—	17BB	11276	50.00	72.00	7.00	—	12BB	12206	50.00	87.00	12.50	—	12BA
22548	50.00	63.00	8.00	—	12BB	11276	50.00	72.00	7.00	—	12BB	22337	50.00	90.00	8.00	—	15BB
22315	50.00	64.00	10.00	—	12BB	12070	50.00	72.00	8.00	—	15BA	11651	50.00	90.00	9.50	—	12BB
14870	50.00	64.00	13.00	—	15BA	12547	50.00	72.00	8.00	—	15B.	11651	50.00	90.00	9.50	—	12BB
21361	50.00	65.00	7.00	—	15BA	12547	50.00	72.00	8.00	—	15BB	18260	50.00	90.00	10.00	—	113
14442	50.00	65.00	8.00	—	15BB	12547	50.00	72.00	8.00	—	15B.	14457	50.00	90.00	10.00	—	15BB
14442	50.00	65.00	8.00	—	15BB	11268	50.00	72.00	8.00	—	12BB	16128	50.00	90.00	10.00	—	12BB
14442	50.00	65.00	8.00	—	15BB	12547	50.00	72.00	8.00	—	15BB	16128	50.00	90.00	10.00	—	12BA
22316	50.00	65.00	8.00	—	15BA	12547	50.00	72.00	8.00	—	15BA	14458	50.00	90.00	12.00	—	15B
14442	50.00	65.00	8.00	—	15B.	14448	50.00	72.00	10.00	—	15B.	11664	50.00	90.00	13.00	—	15BB
13591	50.00	65.00	8.00	—	12BB	14448	50.00	72.00	10.00	—	15BB	11193	50.00	90.00	13.00	—	15B.
22317	50.00	65.00	8.00	—	12BA	14448	50.00	72.00	10.00	—	15BB	22340	50.00	90.00	13.00	—	12B.
14442	50.00	65.00	8.00	—	15C	14448	50.00	72.00	10.00	—	15BB	14459	50.00	95.00	10.00	—	15BB
14442	50.00	65.00	8.00	—	15BB	14448	50.00	72.00	10.00	—	15BB	14459	50.00	95.00	10.00	—	15B.
13591	50.00	65.00	8.00	—	12BB	14448	50.00	72.00	10.00	—	15BA	16722	50.00	110.00	10.00	—	12BA
13133	50.00	65.00	8.50	—	12BB	14448	50.00	72.00	10.00	—	15BB	16899	50.00	154.00	24.00	—	TDUO
14443	50.00	65.00	10.00	—	15BA	12210	50.00	72.00	10.00	—	12BB	22341	50.01	65.09	7.54	—	12BB
14443	50.00	65.00	10.00	—	15B.	12210	50.00	72.00	10.00	—	12BA	14761	50.01	65.48	7.94	—	ESPE
14443	50.00	65.00	10.00	—	15B.	12209	50.00	72.00	12.00	—	12BB	22342	50.01	66.68	6.35	—	15BA
14443	50.00	65.00	10.00	—	15BB	14449	50.00	72.00	12.00	—	15BB	17284	50.01	68.26	12.70	—	15B.





# Retentores

Perfis - Ver Última Página



INCOVE VEDAÇÕES LTDA.

Cod.	Di	De	Ha1	Ha2	Mod	Cod.	Di	De	Ha1	Ha2	Mod	Cod.	Di	De	Ha1	Ha2	Mod
17783	50.01	69.85	12.70	—	I5B.	17142	50.80	69.06	16.67	—	I2BC	15038	50.80	76.20	12.70	—	I5BB
22343	50.01	69.85	12.70	—	I5BA	15380	50.80	69.85	6.35	—	I13	15038	50.80	76.20	12.70	—	I5BB
15577	50.01	73.03	11.91	—	I5B.	17481	50.80	69.85	6.35	—	I4BA	15038	50.80	76.20	12.70	—	I5BA
22344	50.01	73.03	12.70	—	I5BB	17481	50.80	69.85	6.35	—	I4C	15038	50.80	76.20	12.70	—	I5B.
17036	50.01	73.03	19.05	—	I1BF	20416	50.80	69.85	7.95	—	I2BA	11352	50.80	76.20	12.70	—	I2BA
14761	50.01	73.82	7.94	—	ESPE	12279	50.80	69.85	9.53	—	I2BB	15038	50.80	76.20	12.70	—	I5BB
15624	50.01	75.41	6.35	—	I4	13367	50.80	69.85	9.53	—	I5BB	20121	50.80	76.20	12.70	—	I7B.
15335	50.01	75.41	7.94	—	I13	12279	50.80	69.85	9.53	—	I2BB	15038	50.80	76.20	12.70	—	I5C
15084	50.01	76.20	12.70	—	I5B.	13367	50.80	69.85	9.53	—	I5B.	16203	50.80	76.20	15.87	—	I3BC
14713	50.01	76.20	12.70	—	I813	13367	50.80	69.85	9.53	—	I5BB	22367	50.80	76.20	15.88	—	I2B.
17412	50.01	84.93	11.91	—	I5B.	12279	50.80	69.85	9.53	—	I2BB	17273	50.80	76.20	15.88	—	I3
18585	50.01	84.93	19.05	—	I1BF	13367	50.80	69.85	9.53	—	I5C	15788	50.80	76.20	15.88	—	I12C
15123	50.01	87.31	16.67	—	ESPE	13367	50.80	69.85	9.53	—	I5BB	15239	50.80	76.20	17.46	—	I2BA
16856	50.74	77.79	7.14	—	I4BB	15557	50.80	69.85	11.11	—	F	12388	50.80	76.20	18.26	—	I1FC
15914	50.80	58.10	11.50	—	ESPE	18591	50.80	69.85	11.11	—	I7B.	12388	50.80	76.20	18.26	—	I1FC
20393	50.80	60.33	6.35	—	I5BB	17122	50.80	69.85	12.70	—	I5B.	12388	50.80	76.20	18.26	—	I1FC
14750	50.80	61.12	9.53	—	I55B	17122	50.80	69.85	12.70	—	I5BB	22368	50.80	76.20	18.26	—	I2B.
12289	50.80	61.91	7.94	—	I5BA	17122	50.80	69.85	12.70	—	I5BA	12388	50.80	76.20	18.26	—	I2B.
18586	50.80	63.50	6.35	—	I4BB	17122	50.80	69.85	12.70	—	I5C	12388	50.80	76.20	18.30	—	I9B
18586	50.80	63.50	6.35	—	I4BA	17215	50.80	69.85	15.88	—	I2BB	15304	50.80	76.20	19.05	—	I1BF
16656	50.80	63.50	6.35	—	I5BA	16604	50.80	69.85	19.05	—	I5B.	18594	50.80	76.20	22.23	—	I7
18586	50.80	63.50	6.35	—	I4C	15804	50.80	69.85	20.64	—	ESPE	15038	50.80	76.25	12.70	—	I5C
18909	50.80	63.50	7.50	—	I5BB	22359	50.80	70.25	16.67	—	I2B.	15867	50.80	77.79	11.11	—	I13
22349	50.80	63.50	7.94	—	I5BA	15098	50.80	70.25	16.67	—	I3C	22369	50.80	77.79	11.91	—	I5BB
22499	50.80	63.50	9.53	—	I5BA	15098	50.80	70.25	16.67	—	I3B.	17272	50.80	77.79	12.70	—	I13
13996	50.80	63.50	11.11	—	I5B.	18592	50.80	70.64	13.49	—	I5BB	15518	50.80	77.79	12.70	—	I5B.
18587	50.80	63.50	12.70	—	I5BA	15720	50.80	71.44	7.94	—	F	15518	50.80	77.79	12.70	—	I5C
18587	50.80	63.50	12.70	—	I5B.	12292	50.80	72.00	11.90	—	I5B.	18595	50.80	77.79	14.29	—	I80
12903	50.80	65.09	6.35	—	I4BA	12292	50.80	72.00	11.91	—	I5B.	15314	50.80	77.79	20.64	—	I131
22350	50.80	65.09	7.94	—	I2BB	18593	50.80	73.03	6.35	—	I4	18176	50.80	78.58	9.53	—	I13
22351	50.80	65.09	11.91	—	I2BA	22360	50.80	73.03	7.94	—	I2BA	22370	50.80	79.38	9.53	—	I5BB
14710	50.80	65.09	12.70	—	I2BA	15931	50.80	73.03	9.53	—	I5BB	22371	50.80	79.38	9.53	—	I2B.
18588	50.80	65.09	12.70	—	I5BB	15931	50.80	73.03	9.53	—	I5BA	17740	50.80	79.38	10.50	—	I5BA
14710	50.80	65.09	12.70	—	I2BB	15931	50.80	73.03	9.53	—	I5BA	13418	50.80	79.38	11.11	—	I5BA
14772	50.80	65.10	12.70	—	I4BA	15931	50.80	73.03	9.53	—	I5B.	13418	50.80	79.38	11.11	—	I5BA
14772	50.80	65.10	12.70	—	I4BA	15931	50.80	73.03	9.53	—	I5C	16655	50.80	79.38	12.70	—	I5BA
17834	50.80	66.68	6.35	—	I4BB	22361	50.80	73.03	11.91	—	I5B.	14455	50.80	79.90	10.00	—	I5BA
17834	50.80	66.68	6.35	—	I4BA	11094	50.80	73.03	11.91	—	I2BA	14456	50.80	80.00	12.70	—	I5B.
13422	50.80	66.68	6.35	—	I5BA	17080	50.80	73.03	12.70	—	F	19049	50.80	80.17	12.70	—	I5B.
17834	50.80	66.68	6.35	—	I4BA	15187	50.80	73.03	12.70	—	I5B.	18057	50.80	80.17	29.37	—	ESPE
13422	50.80	66.68	6.35	—	I5BA	22363	50.80	73.03	12.70	—	I5B.	25365	50.80	80.40	6.35	—	I4BA
13706	50.80	66.68	7.94	—	I5JM	15187	50.80	73.03	12.70	—	I5C	15144	50.80	80.96	11.11	—	I5BA
13706	50.80	66.68	7.94	—	I5BB	14001	50.80	73.03	17.46	—	ESPE	15144	50.80	80.96	11.11	—	I5C
22352	50.80	66.68	8.73	—	I5BA	15161	50.80	73.03	17.46	—	ESPE	13281	50.80	80.96	11.91	—	I2B.
15308	50.80	66.68	9.53	—	F	14001	50.80	73.03	17.46	—	I7B.	22373	50.80	80.96	11.91	—	I5B.
22353	50.80	66.68	9.53	—	I5BA	17762	50.80	73.03	17.46	—	I3BC	13281	50.80	80.96	11.91	—	I2BB
17620	50.80	66.68	12.70	—	I5BA	17991	50.80	73.03	19.05	—	ESPE	22374	50.80	80.96	11.91	—	I2B.
15261	50.80	66.68	15.08	—	ESPE	17126	50.80	73.03	19.05	—	I1FC	15144	50.80	80.96	11.91	—	I5C
13706	50.80	66.72	7.90	—	I5BA	12387	50.80	73.20	12.70	—	I5B.	14002	50.80	80.96	19.05	—	I301
18589	50.80	68.26	6.35	—	I4B.	17594	50.80	73.42	12.70	—	I5BA	15847	50.80	80.96	19.05	—	I5B.
18058	50.80	68.26	9.53	—	I5BA	22365	50.80	75.00	13.00	—	I5B.	18596	50.80	82.55	12.70	—	I5BB
18058	50.80	68.26	9.53	—	I5B.	15624	50.80	75.41	6.35	—	I4	18596	50.80	82.55	12.70	—	I5B.
12851	50.80	68.26	9.53	—	ESPE	15335	50.80	75.41	7.94	—	I13	22375	50.80	82.55	12.70	—	I2B.
18058	50.80	68.26	9.53	—	I5BA	15335	50.80	75.41	7.94	—	I4BA	18203	50.80	82.55	19.05	—	I1BF
18058	50.80	68.26	9.53	—	I5B.	17383	50.80	75.41	12.70	—	I5B.	15158	50.80	84.14	6.35	—	F
22354	50.80	68.26	11.11	—	I5B.	15573	50.80	76.20	6.35	—	I4B.	19050	50.80	84.93	11.11	—	I5BA
17214	50.80	68.26	12.70	—	I5JM	12516	50.80	76.20	7.90	—	I2BA	18597	50.80	85.73	6.35	—	I4
17214	50.80	68.26	12.70	—	I5B.	12516	50.80	76.20	7.94	—	I2BA	15142	50.80	85.73	11.91	—	I5BA
19981	50.80	68.26	17.46	—	I7B.	17230	50.80	76.20	9.53	—	F	15142	50.80	85.73	11.91	—	I5B.
18173	50.80	68.26	19.05	—	ESPE	18254	50.80	76.20	9.53	—	I5BB	15953	50.80	85.73	15.08	—	ESPE
18908	50.80	68.66	6.35	—	I5B.	18254	50.80	76.20	9.53	—	I5BA	17683	50.80	87.31	17.46	—	ESPE
22356	50.80	68.98	11.91	—	I2BB	12704	50.80	76.20	9.53	—	I2BA	18273	50.80	88.90	7.94	—	ESPE
14903	50.80	69.06	6.35	—	I4B.	18254	50.80	76.20	9.53	—	I5C	16580	50.80	88.90	9.52	—	I5BB
22357	50.80	69.06	11.51	—	I5B.	18254	50.80	76.20	9.53	—	I5B.	15629	50.80	88.90	9.53	—	I13
18590	50.80	69.06	11.91	—	I13	17817	50.80	76.20	11.91	—	I4	17515	50.80	90.09	12.70	—	I5B.
12909	50.80	69.06	11.91	—	I2BB	15038	50.80	76.20	12.70	—	I5BB	15311	50.80	90.49	12.70	—	I13
17025	50.80	69.06	11.91	—	I5B.	15038	50.80	76.20	12.70	—	I5JM	15758	50.80	91.28	11.11	—	I55



# Retentores

Perfis - Ver Última Página



INCOVE VEDAÇÕES LTDA.

Cod.	Di	De	Ha1	Ha2	Mod	Cod.	Di	De	Ha1	Ha2	Mod	Cod.	Di	De	Ha1	Ha2	Mod
17866	50.80	92.08	6.35	—	F	14462	52.00	72.00	10.00	—	I5BB	15301	52.39	80.96	11.11	—	I13
17167	50.80	92.08	9.53	—	I13	13241	52.00	72.00	12.00	—	I5B.	22415	52.39	80.96	11.51	—	I5BB
15740	50.80	92.08	12.70	—	I5BA	13241	52.00	72.00	12.00	—	I2BA	18334	52.39	80.96	14.29	—	I2
17823	50.80	93.66	9.53	—	I4BA	14463	52.00	72.00	12.00	—	I5BB	15732	52.39	80.96	20.64	—	ESPE
17823	50.80	93.66	9.53	—	I13	14463	52.00	72.00	12.00	—	I5B.	22417	52.39	82.55	12.70	—	I5BA
18079	50.80	93.66	12.70	—	F	13241	52.00	72.00	12.00	—	I2BA	22418	52.39	82.55	12.70	—	I2B.
13549	50.80	95.25	19.50	—	I1FB	14463	52.00	72.00	12.00	—	I5C	17453	52.39	82.55	12.70	—	I5C
18126	50.80	98.43	25.40	—	I1	22394	52.00	75.00	10.00	—	I5BB	15509	52.39	82.55	12.70	—	I80
15786	50.80	98.43	41.28	—	I13	14465	52.00	75.00	12.00	—	I5B.	22419	52.39	84.93	11.91	—	I5B.
15784	50.80	100.00	22.23	—	I13	22395	52.00	75.00	12.00	—	I5B.	18599	52.39	84.93	12.70	—	I5B.
22377	50.80	101.60	11.91	—	I5B.	22396	52.00	75.00	12.00	—	I2BA	15654	52.39	84.93	31.75	—	I5B.
18598	50.80	101.60	12.70	—	I5B.	13131	52.00	75.00	13.00	—	I55B	18600	52.39	85.73	11.91	—	I5B.
19936	50.80	104.80	12.70	—	I80	12784	52.00	76.00	16.00	—	I5B.	19052	52.39	88.50	11.11	—	I5B.
16618	50.80	111.13	9.53	—	I5BB	22397	52.00	76.50	9.00	—	I5BA	19053	52.39	88.90	11.11	—	I5B.
18841	50.80	111.13	15.88	—	I55	22398	52.00	78.00	10.00	—	I5BA	15397	52.39	88.90	22.23	—	I1
15438	50.80	111.13	16.67	—	I55B	14466	52.00	80.00	10.00	—	I5BB	15403	52.39	92.08	9.53	—	I13
15354	50.80	111.13	17.46	—	ESPE	14466	52.00	80.00	10.00	—	I5BB	17304	52.39	92.08	11.91	—	I5BB
15438	50.80	114.30	16.67	19.84	I55B	20316	52.00	80.00	10.00	—	I2BB	25238	52.39	92.08	11.91	—	I5B.
15362	50.80	114.30	17.46	—	I55	11696	52.00	80.00	13.00	—	I5BB	15729	52.39	95.25	12.70	—	I813
15436	50.80	114.30	19.80	—	DISC	22401	52.00	80.00	13.00	—	I2BA	15723	52.39	95.25	29.37	—	I55
15436	50.80	114.30	19.80	—	ESPE	RU08	52.00	82.00	13.00	—	I2	15441	52.39	120.70	11.91	—	I55
17666	50.80	115.90	12.70	—	I55B	23522	52.00	83.00	12.00	—	I5BB	17577	52.39	120.70	14.29	—	I5B.
15833	50.80	115.90	14.20	—	DISC	14824	52.00	85.00	10.00	—	I5BA	15866	52.39	123.80	19.05	—	I55B
15833	50.80	115.90	14.29	—	ESPE	12798	52.00	85.00	10.00	—	I2BB	15866	52.39	123.80	19.05	—	I5BA
14753	50.80	115.90	15.88	—	ESPE	13131	52.00	88.00	13.00	—	ESPE	17249	52.39	128.60	17.46	—	I55
17372	50.80	120.70	20.64	—	I55C	22405	52.00	90.00	13.00	—	I5B.	15528	52.39	131.80	14.29	—	I13
17460	50.80	123.80	19.05	—	I55C	16173	52.38	88.90	12.70	—	I2BB	17626	52.39	131.80	16.67	—	I13
15680	50.80	126.20	15.08	—	I55	12299	52.39	61.30	11.50	—	ESPE	15615	52.39	136.50	23.02	—	I55
15691	50.80	126.20	19.05	—	I55C	13615	52.39	63.50	3.97	—	I4BA	15884	52.40	68.00	10.50	—	I5BB
—	51.00	58.00	4.00	—	I4BA	18107	52.39	63.50	9.53	—	F	15884	52.40	68.00	10.50	—	I5BB
—	51.00	65.00	4.00	—	I5BA	13699	52.39	65.09	4.76	—	I4BA	12346	52.40	74.70	8.30	—	ESPE
14460	51.00	67.00	10.00	—	I5BB	22406	52.39	68.26	15.88	—	I5BA	20119	52.40	76.00	9.00	—	I5B.
14460	51.00	67.00	10.00	—	I5B.	12001	52.39	69.85	9.53	—	I5BA	16472	52.40	76.17	7.00	—	I5BB
13132	51.00	72.00	10.00	—	I13	22407	52.39	69.85	12.70	—	I5B.	13477	52.40	76.30	7.90	—	I5BA
22378	51.00	72.00	12.00	—	I5B.	15012	52.39	72.23	11.11	—	I5B.	16304	52.40	80.14	6.40	—	I4BA
22379	51.00	80.00	10.00	—	I2B.	15012	52.39	72.23	11.11	—	I5BB	15126	52.40	80.15	6.40	—	I4BA
17299	51.20	82.55	11.91	—	I5B.	15012	52.39	72.23	11.11	—	I5C	15126	52.40	80.15	6.40	—	I4BA
15723	51.20	82.55	32.54	—	I55	22411	52.39	72.23	11.51	—	I5BA	15126	52.40	80.17	6.35	—	I13
15146	51.20	108.00	11.11	—	I13	17087	52.39	73.03	9.53	—	I5BA	15005	52.40	80.96	11.11	—	I5C
22571	51.35	76.30	8.00	—	I5B.	17087	52.39	73.03	9.53	—	I5BA	25239	52.50	66.00	8.10	—	I5BB
25453	51.50	84.00	6.00	—	I5BB	13199	52.39	73.03	12.70	—	I5BA	25240	52.80	82.60	10.00	—	I5BB
22380	51.59	76.20	12.70	—	I5BA	13199	52.39	73.03	12.70	—	I5BA	11001	53.00	65.00	5.00	—	I4BB
22381	51.59	85.73	11.91	—	I5B.	15396	52.39	73.03	13.49	—	I13	20188	53.00	65.00	6.00	—	I2BB
16837	51.90	73.00	11.50	—	I2B.	16896	52.39	76.20	6.99	—	I2BB	25241	53.00	68.00	10.00	—	I5B.
11519	52.00	61.00	7.00	—	I5BB	13477	52.39	76.20	7.94	—	I5BA	25242	53.00	68.00	10.50	—	I5BB
11198	52.00	64.00	10.00	—	I5BB	19913	52.39	76.20	7.94	—	I4BB	25243	53.00	70.00	6.00	—	I5BB
22383	52.00	65.00	6.00	—	I5BB	13477	52.39	76.20	7.94	—	I5BA	20134	53.00	72.00	9.00	—	I2BB
20332	52.00	68.00	7.00	—	I5BA	19913	52.39	76.20	7.94	—	I4BA	16035	53.00	72.70	12.00	—	I5B.
22384	52.00	68.00	8.00	—	I5BA	13477	52.39	76.20	7.94	—	I5BA	25244	53.00	72.70	12.00	—	I2B.
13710	52.00	68.00	8.00	—	I5BB	19913	52.39	76.20	7.94	—	I4C	14467	53.00	73.00	10.00	—	I5BB
22385	52.00	68.00	10.00	—	I5BB	16120	52.39	76.20	12.70	—	I5BB	16727	53.00	73.00	16.00	—	I2BA
12558	52.00	68.00	10.00	—	I2BB	15894	52.39	76.20	12.70	—	I5B.	20092	53.00	73.50	10.00	—	I5BB
12558	52.00	68.00	10.00	—	I2BA	16139	52.39	76.20	12.70	—	I2B.	25245	53.00	75.00	10.00	—	I5B.
22386	52.00	68.00	10.50	—	I5BB	18031	52.39	76.20	19.05	—	I1FC	25246	53.00	75.00	12.00	—	I5BB
13895	52.00	68.00	12.00	—	I5BB	15628	52.39	77.79	12.70	—	I5B.	25248	53.00	80.00	11.50	—	I5B.
13896	52.00	69.00	10.00	—	I5BB	15628	52.39	77.79	12.70	—	I5B.	25249	53.00	80.00	13.00	—	I5B.
22388	52.00	69.00	12.00	—	I5B.	15736	52.39	78.18	12.70	—	I13	—	53.00	82.00	7.50	—	I4BA
22389	52.00	70.00	8.00	—	I5BB	22414	52.39	79.38	9.53	—	I5B.	16684	53.00	83.00	10.00	—	I5BB
22390	52.00	70.00	10.00	—	I5B.	17078	52.39	79.38	12.70	—	I5B.	16684	53.00	83.00	10.00	—	I5B.
11712	52.00	71.00	13.00	—	I5BA	15613	52.39	80.17	9.53	—	I13	20037	53.00	90.00	7.80	—	I5BB
22392	52.00	72.00	8.00	—	I5BA	14835	52.39	80.17	11.11	—	ESPE	18621	53.00	90.00	10.00	—	I13
22391	52.00	72.00	8.00	—	I5BB	19051	52.39	80.17	11.11	—	I5B.	13715	53.00	90.00	20.00	—	I9B.
12281	52.00	72.00	10.00	—	I2BA	17565	52.39	80.17	17.46	—	I13	11870	53.00	98.00	7.30	—	I5BB
14462	52.00	72.00	10.00	—	I5BB	16304	52.39	80.96	6.35	—	I4BA	16543	53.10	80.20	7.80	—	I5BB
14462	52.00	72.00	10.00	—	I5BA	15005	52.39	80.96	11.11	—	I5B.	17064	53.18	69.06	9.53	—	I13
12281	52.00	72.00	10.00	—	I2BA	18039	52.39	80.96	11.11	—	I13	18601	53.18	69.85	6.35	—	I4
14462	52.00	72.00	10.00	—	I5BB	15005	52.39	80.96	11.11	—	I5BB	17769	53.18	72.23	6.35	—	I4BA



# Retentores

Perfis - Ver Última Página



INCOVE VEDAÇÕES LTDA.

Cod.	Di	De	Ha1	Ha2	Mod	Cod.	Di	De	Ha1	Ha2	Mod	Cod.	Di	De	Ha1	Ha2	Mod
15692	53.18	76.20	12.70	—	113	15047	53.98	77.79	12.70	—	15BA	18606	53.98	90.09	12.70	—	15B.
15331	53.18	80.17	6.35	—	14	25263	53.98	77.79	12.70	—	15B.	18606	53.98	90.09	12.70	—	15BA
15152	53.18	108.00	11.11	—	113	.....	53.98	77.79	12.70	—	12BA	15283	53.98	92.08	7.94	—	F
25250	53.50	90.00	6.00	—	15BB	15047	53.98	77.79	12.70	—	15B.	18607	53.98	92.08	11.91	—	15B.
16746	53.90	77.80	18.00	—	15BB	15047	53.98	77.79	12.70	—	15C	18608	53.98	98.43	11.91	—	15B.
22550	53.97	76.20	7.93	—	15JL	15938	53.98	77.79	17.46	—	13BC	18609	53.98	100.00	11.91	—	180
22524	53.98	63.50	7.90	—	15BB	15938	53.98	77.79	17.46	—	13C	17995	53.98	104.80	28.58	—	113
13622	53.98	65.09	4.76	—	14BB	16746	53.98	77.79	18.00	—	15BB	17322	53.98	114.30	10.32	—	113
19922	53.98	65.09	7.94	—	15BA	13346	53.98	77.79	19.05	—	12B.	15760	53.98	115.10	15.88	—	15B.
18011	53.98	68.26	12.70	—	15B.	25264	53.98	77.79	19.05	—	12B.	19999	53.98	119.10	12.70	—	ESPE
18011	53.98	68.26	12.70	—	15C	17180	53.98	77.79	19.05	—	11FC	17638	53.98	152.40	16.67	—	15B.
25251	53.98	69.85	7.94	—	15BA	17180	53.98	77.79	19.05	—	11FB	19972	53.98	152.40	34.93	—	155
15476	53.98	69.85	11.11	—	F	17321	53.98	79.38	7.14	—	113	16390	54.00	65.00	8.00	—	12B.
18602	53.98	72.23	11.91	—	15BA	15167	53.98	79.38	12.70	—	15B	16390	54.00	65.00	8.00	—	12B.
15832	53.98	73.03	6.35	—	14BB	12204	53.98	79.38	12.70	—	12BA	13779	54.00	70.00	8.00	—	15BA
15832	53.98	73.03	6.35	—	14BA	15167	53.98	79.38	12.70	—	15B.	13779	54.00	70.00	8.00	—	15BA
12521	53.98	73.03	6.35	—	15BA	12204	53.98	79.38	12.70	—	12BA	13538	54.00	70.00	10.00	—	15BB
15832	53.98	73.03	6.35	—	14BA	17450	53.98	79.38	12.70	—	113	25277	54.00	70.00	10.00	—	15BA
15832	53.98	73.03	6.35	—	14BB	17701	53.98	79.38	12.70	—	180B	14468	54.00	70.00	12.00	—	15BB
25253	53.98	73.03	7.94	—	15BB	15167	53.98	79.38	12.70	—	15BB	14468	54.00	70.00	12.00	—	15BA
17802	53.98	73.03	7.94	—	12BC	25265	53.98	79.38	12.70	—	15B.	14468	54.00	70.00	12.00	—	15B.
17601	53.98	73.03	9.53	—	15BB	25267	53.98	79.38	12.70	—	12BA	14468	54.00	70.00	12.00	—	15BB
17601	53.98	73.03	9.53	—	15BA	15167	53.98	79.38	12.70	—	15BA	14468	54.00	70.00	12.00	—	15BA
11454	53.98	73.03	9.53	—	12BB	17701	53.98	79.38	12.70	—	180C	14472	54.00	72.00	8.00	—	15BB
13553	53.98	73.03	9.53	—	12BA	17685	53.98	79.38	19.05	—	11BF	25279	54.00	72.00	8.00	—	15BB
17601	53.98	73.03	9.53	—	15C	17685	53.98	79.38	19.05	—	11FC	25280	54.00	72.00	10.00	—	15B.
13553	53.98	73.03	10.32	—	12B.	19967	53.98	79.38	23.81	—	ESPE	13520	54.00	72.00	11.00	—	15BB
25254	53.98	73.03	11.11	—	15B.	S2287	53.98	79.38	95.25	—	12B.	11977	54.00	73.00	9.50	—	12BB
25255	53.98	73.03	11.11	—	12B.	19054	53.98	80.17	11.11	—	15BB	16626	54.00	73.00	9.50	—	12BB
15375	53.98	73.03	11.11	—	F	15742	53.98	80.96	9.53	—	F	16531	54.00	73.00	10.00	—	12BA
25256	53.98	73.03	11.91	—	15BB	14070	53.98	80.96	11.11	—	12BB	12817	54.00	73.00	11.00	—	12BA
15048	53.98	73.03	12.70	—	15B.	25268	53.98	80.96	11.11	—	15B.	12817	54.00	73.00	11.00	—	12BA
15048	53.98	73.03	12.70	—	15BB	15399	53.98	80.96	11.11	—	15C	14469	54.00	74.00	13.00	—	180
15048	53.98	73.03	12.70	—	15BA	25269	53.98	80.96	11.91	—	15BB	16041	54.00	76.20	8.00	—	15BB
15048	53.98	73.03	12.70	—	15B.	22558	53.98	80.96	11.91	—	12BB	—	54.00	77.70	11.00	—	12BB
15048	53.98	73.03	12.70	—	15C	17770	53.98	80.96	17.46	—	112C	—	54.00	77.70	11.00	—	12BB
15398	53.98	73.03	15.88	—	13C	17770	53.98	80.96	17.46	—	112B	13633	54.00	78.00	9.50	—	12BA
25257	53.98	73.03	17.07	—	12B.	17229	53.98	80.96	19.05	—	11FC	.....	54.00	79.35	9.50	—	12B.
13314	53.98	73.03	17.46	—	12B	17455	53.98	80.96	19.84	—	155	13502	54.00	80.00	10.00	—	15BB
18271	53.98	73.03	17.46	—	11BF	14885	53.98	80.96	22.23	—	13BA	25281	54.00	80.00	10.00	—	15B.
17764	53.98	73.03	19.05	—	11	13043	53.98	81.36	21.03	—	19B	25282	54.00	80.00	13.00	—	15B.
17060	53.98	76.20	6.35	—	14	25271	53.98	82.55	9.53	—	15BA	16743	54.00	80.00	13.00	—	12BB
12203	53.98	76.20	7.94	—	12BB	16424	53.98	82.55	9.53	—	12BB	15399	54.00	81.10	12.00	—	15BB
12041	53.98	76.20	7.94	—	15B.	16895	53.98	82.55	11.91	—	12BB	12338	54.00	81.20	20.70	—	19B
12203	53.98	76.20	7.94	—	12BB	18298	53.98	82.55	12.70	—	15BA	13519	54.00	82.00	11.00	—	15BB
16619	53.98	76.20	9.52	—	12BB	18298	53.98	82.55	12.70	—	15B.	25283	54.00	85.00	10.00	—	15B.
16619	53.98	76.20	9.52	—	12BA	18298	53.98	82.55	12.70	—	15BA	12377	54.00	90.00	12.50	—	12BA
25259	53.98	76.20	9.53	—	15B.	18298	53.98	82.55	12.70	—	15C	13142	54.00	99.00	38.00	—	ESPE
25260	53.98	76.20	11.11	—	12B.	18603	53.98	82.55	15.88	—	13	13142	54.00	148.00	38.00	—	ESPE
15664	53.98	76.20	12.70	—	15BA	16034	53.98	84.13	12.70	—	15B.	12302	54.10	73.00	8.50	—	12BA
12211	53.98	76.20	12.70	—	12BA	17572	53.98	84.93	6.35	—	14C	12302	54.10	73.00	8.50	—	12BA
15664	53.98	76.20	12.70	—	15BB	15550	53.98	84.93	11.91	—	15C	18348	54.17	80.96	11.11	—	15B.
22443	53.98	76.20	12.70	—	15B.	15550	53.98	84.93	11.91	—	15B.	18610	54.17	82.55	6.35	—	14B.
12211	53.98	76.20	12.70	—	12BA	15550	53.98	84.93	11.91	—	15C	18244	54.17	82.55	12.70	—	15B.
12211	53.98	76.20	12.70	—	12B.	18604	53.98	84.93	15.08	—	13	17684	54.17	84.93	11.91	—	15BB
15664	53.98	76.20	12.70	—	15B.	15655	53.98	84.93	31.75	—	15B.	16032	54.76	80.96	11.90	—	12BB
15664	53.98	76.20	12.70	—	15C	15803	53.98	85.33	19.05	—	11	25284	54.77	80.96	11.11	—	15B.
15664	53.98	76.20	12.70	—	15BA	25272	53.98	85.73	11.91	—	15BA	25285	54.77	82.55	12.70	—	15BB
15703	53.98	76.20	14.68	—	113	15821	53.98	85.73	11.91	—	15BA	25286	54.77	85.33	11.91	—	15BB
17800	53.98	76.20	15.88	—	13B.	19055	53.98	87.31	11.11	—	15B.	20065	54.80	82.70	12.70	—	15BB
15055	53.98	76.20	19.05	—	11FB	12042	53.98	88.90	7.94	—	15B.	20354	55.00	57.00	7.00	—	15BB
15055	53.98	76.20	19.05	—	11FC	25273	53.98	88.90	9.53	—	12BA	—	55.00	62.90	5.00	—	14BA
17671	53.98	76.20	22.23	—	19C	19056	53.98	88.90	11.11	—	15BB	11349	55.00	63.00	5.00	—	15BB
25261	53.98	76.60	12.70	—	15BA	25275	53.98	88.90	11.11	—	12B.	12860	55.00	63.00	7.00	—	15BA
15314	53.98	76.99	21.43	—	113	18605	53.98	88.90	17.46	—	19	25288	55.00	63.00	10.50	—	15BB
15047	53.98	77.79	12.70	—	15BB	17766	53.98	88.90	19.05	—	17B.	13046	55.00	65.00	5.00	—	14BB
15047	53.98	77.79	12.70	—	15BB	17766	53.98	88.90	20.64	—	17BB	13009	55.00	65.00	8.00	—	15BA



# Retentores

Perfis - Ver Última Página



INCOVE VEDAÇÕES LTDA.

Cod.	Di	De	Ha1	Ha2	Mod	Cod.	Di	De	Ha1	Ha2	Mod	Cod.	Di	De	Ha1	Ha2	Mod
13770	55.00	66.00	8.00	—	14BB	16279	55.00	75.00	14.00	—	12B.	14481	55.00	90.00	12.00	—	15BB
13770	55.00	66.00	8.00	—	14BB	20339	55.00	75.00	16.00	—	12BB	25315	55.00	90.00	12.50	—	12BA
22504	55.00	66.00	10.00	—	15B.	21355	55.00	76.00	10.00	—	15BB	14481	55.00	90.00	12.70	—	15B
12020	55.00	66.00	12.00	—	15BA	13676	55.00	76.00	10.00	—	15BA	14481	55.00	90.00	12.70	—	15C
16258	55.00	67.00	6.00	—	15BB	13794	55.00	76.00	12.00	—	15BB	14481	55.00	90.00	12.70	—	15BA
16695	55.00	67.00	10.00	—	15BB	13794	55.00	76.00	12.00	—	15BA	25316	55.00	90.00	13.00	—	15B.
13055	55.00	68.00	4.00	—	14BB	25300	55.00	76.00	12.00	—	12BB	16842	55.00	98.70	12.00	—	12B.
16870	55.00	68.00	6.00	—	15BB	11036	55.00	76.00	12.00	—	12BA	25317	55.00	100.00	10.00	—	12BB
13666	55.00	68.00	8.00	—	15BA	19964	55.00	77.00	100.00	17.00	14B.	14482	55.00	100.00	12.00	—	15B.
13666	55.00	68.00	8.00	—	15BB	25301	55.00	78.00	10.00	—	15BB	25318	55.00	100.00	12.50	—	15B.
13666	55.00	68.00	8.00	—	15BB	16155	55.00	78.00	10.00	—	12BB	14482	55.00	100.00	12.70	—	15BB
13666	55.00	68.00	8.00	—	15B.	25302	55.00	78.00	12.00	—	15BB	16393	55.00	100.00	12.70	—	12BB
11333	55.00	68.00	10.00	—	15BB	16151	55.00	78.00	12.00	—	12BA	RU09	55.00	100.00	13.00	—	15B.
14470	55.00	70.00	8.00	—	15BA	16151	55.00	78.00	12.00	—	12BB	14483	55.00	101.60	10.00	—	15BA
14470	55.00	70.00	8.00	—	15BA	16151	55.00	78.00	12.00	—	12BB	14483	55.00	102.00	10.00	—	15B.
14470	55.00	70.00	8.00	—	15BB	25303	55.00	78.00	13.00	—	15B.	25319	55.17	72.23	7.94	—	15BB
11139	55.00	70.00	8.00	—	15BA	11140	55.00	78.00	13.00	—	12B.	—	55.40	76.15	12.70	—	12BA
14470	55.00	70.00	8.00	—	15BB	25304	55.00	80.00	6.00	—	15BA	11765	55.50	81.10	15.50	—	12BA
14470	55.00	70.00	8.00	—	15BB	11258	55.00	80.00	8.00	—	12BB	11998	55.50	82.50	12.70	—	12BB
14470	55.00	70.00	8.00	—	15BA	11258	55.00	80.00	8.00	—	15JM	15371	55.56	66.68	7.14	—	CORT
14470	55.00	70.00	8.00	—	15B.	11258	55.00	80.00	8.00	—	15BB	17325	55.56	68.26	9.53	—	CORT
11139	55.00	70.00	8.00	—	15BB	11258	55.00	80.00	8.00	—	15BA	15271	55.56	71.44	9.53	—	F
11139	55.00	70.00	8.00	—	12BA	11258	55.00	80.00	8.00	—	15BB	15738	55.56	72.23	7.14	—	14C
11139	55.00	70.00	8.00	—	12BB	25402	55.00	80.00	9.00	—	15B.	11069	55.56	72.23	14.29	—	15BB
13538	55.00	70.00	10.00	—	15BB	14477	55.00	80.00	10.00	—	15BB	15725	55.56	73.03	9.53	—	CORT
14701	55.00	70.00	12.00	—	15BB	14477	55.00	80.00	10.00	—	15BB	25320	55.56	73.03	11.91	—	15B.
14701	55.00	70.00	12.00	—	15BB	14477	55.00	80.00	10.00	—	15B.	15614	55.56	73.03	12.70	—	155
20372	55.00	70.00	14.00	—	15BA	11205	55.00	80.00	10.00	—	12BB	16973	55.56	76.20	9.53	—	15B.
25291	55.00	70.50	12.00	—	15BB	14477	55.00	80.00	10.00	—	15BB	17237	55.56	76.20	11.91	—	15BA
15721	55.00	72.00	7.00	—	F	14477	55.00	80.00	10.00	—	15B.	17237	55.56	76.20	11.91	—	15B.
14472	55.00	72.00	8.00	—	15BB	14477	55.00	80.00	10.00	—	15BB	16775	55.56	76.20	12.70	—	15B.
14472	55.00	72.00	8.00	—	15BA	14477	55.00	80.00	10.00	—	15BA	15086	55.56	77.79	6.35	—	F
14472	55.00	72.00	8.00	—	15BB	12532	55.00	80.00	12.00	—	15BA	15384	55.56	77.79	11.11	—	15B.
16409	55.00	72.00	9.00	—	12BB	25306	55.00	80.00	12.00	—	15BB	15384	55.56	77.79	11.91	—	15B.
25292	55.00	72.00	9.00	—	15BB	12532	55.00	80.00	12.00	—	15B.	17690	55.56	79.38	9.53	—	F
16409	55.00	72.00	9.00	—	12BB	12532	55.00	80.00	12.00	—	15B.	19057	55.56	79.38	11.11	—	15B.
14435	55.00	72.00	10.00	—	15B	12532	55.00	80.00	12.00	—	15BA	19058	55.56	80.17	11.91	—	15BB
14435	55.00	72.00	10.00	—	15BB	14478	55.00	80.00	13.00	—	15BA	25322	55.56	80.96	9.53	—	12BA
13700	55.00	72.00	10.00	—	12BB	14478	55.00	80.00	13.00	—	15BB	25323	55.56	80.96	11.11	—	15BB
14435	55.00	72.00	10.00	—	15BB	14478	55.00	80.00	13.00	—	15BB	25324	55.56	80.96	11.91	—	15B.
25293	55.00	72.00	10.00	—	15BA	14478	55.00	80.00	13.00	—	15BA	15824	55.56	80.96	11.91	—	CORT
13700	55.00	72.00	10.00	—	12BB	25308	55.00	80.00	13.00	—	12BA	17218	55.56	80.96	12.70	—	F
13700	55.00	72.00	10.00	—	12BA	14478	55.00	80.00	13.00	—	15BB	15439	55.56	80.96	12.70	—	15B.
13700	55.00	72.00	10.00	—	12BB	13242	55.00	80.00	13.00	—	12BA	15439	55.56	80.96	12.70	—	15C
13700	55.00	72.00	10.00	—	12BB	14728	55.00	82.00	10.00	—	14BA	17785	55.56	80.96	17.46	—	ESPE
14473	55.00	72.00	12.00	—	15BB	14479	55.00	82.00	12.00	—	15BA	15448	55.56	80.96	19.05	—	11FC
14473	55.00	72.00	12.00	—	15BA	12652	55.00	82.70	9.52	—	12BA	15540	55.56	80.96	20.64	—	ESPE
.....	55.00	72.00	12.00	—	12BA	12389	55.00	85.00	7.00	—	15BB	15448	55.56	81.12	19.05	—	11BF
14473	55.00	72.00	12.00	—	15BB	RU26	55.00	85.00	8.00	—	15B.	11936	55.56	82.55	9.53	—	15BB
14473	55.00	72.00	12.00	—	15BB	25309	55.00	85.00	8.00	—	15BB	11975	55.56	82.55	9.53	—	12BB
25295	55.00	72.00	13.00	—	15BB	12101	55.00	85.00	10.00	—	15BA	11975	55.56	82.55	9.53	—	12BB
22429	55.00	75.00	5.50	—	15BB	12741	55.00	85.00	10.00	—	15BB	17277	55.56	82.55	12.70	—	15BA
12930	55.00	75.00	8.00	—	15BB	11273	55.00	85.00	10.00	—	12B.	17277	55.56	82.55	12.70	—	15B.
12930	55.00	75.00	8.00	—	15BB	15135	55.00	85.00	13.00	—	15BB	13189	55.56	82.55	12.70	—	12B.
13025	55.00	75.00	9.00	—	15BB	14437	55.00	85.00	13.00	—	15BB	13189	55.56	82.55	12.70	—	12B.
14475	55.00	75.00	10.00	—	15BB	14437	55.00	85.00	13.00	—	15BB	17277	55.56	82.55	12.70	—	15C
25297	55.00	75.00	10.00	—	12BB	11571	55.00	85.00	14.00	—	15JM	15838	55.56	82.55	19.05	—	11BF
14475	55.00	75.00	10.00	—	15BB	16565	55.00	85.00	14.00	—	12BA	15547	55.56	82.55	22.23	—	112
14475	55.00	75.00	10.00	—	15BB	20200	55.00	90.00	6.00	—	12BB	25326	55.56	84.93	11.91	—	15B.
14475	55.00	75.00	10.00	—	15BA	11828	55.00	90.00	8.00	—	15BB	15658	55.56	84.93	11.91	—	15B.
14475	55.00	75.00	10.00	—	15BA	11828	55.00	90.00	8.00	—	15BA	15658	55.56	84.93	11.91	—	15C
14475	55.00	75.00	10.00	—	15BB	20203	55.00	90.00	8.00	—	12BB	25327	55.56	84.93	12.70	—	15BA
14476	55.00	75.00	12.00	—	15B.	11828	55.00	90.00	8.00	—	15BB	18612	55.56	84.93	19.05	—	11
14476	55.00	75.00	12.00	—	15BB	14480	55.00	90.00	10.00	—	15BA	15343	55.56	85.73	7.94	—	F
14476	55.00	75.00	12.00	—	15BB	14480	55.00	90.00	10.00	—	15BB	18613	55.56	85.73	11.91	—	15BB
14476	55.00	75.00	12.00	—	15BB	11101	55.00	90.00	10.00	—	12BB	25328	55.56	85.73	12.70	—	15BA
14476	55.00	75.00	12.00	—	15C	14481	55.00	90.00	12.00	—	15B.	14000	55.56	85.73	25.40	—	BOOT





# Retentores

Perfis - Ver Última Página



INCOVE VEDAÇÕES LTDA.

Cod.	Di	De	Ha1	Ha2	Mod	Cod.	Di	De	Ha1	Ha2	Mod	Cod.	Di	De	Ha1	Ha2	Mod
19059	55.56	87.31	11.11	—	I5B.	14831	57.15	66.68	2.78	—	I4B.	18617	57.15	80.96	6.35	—	I4
18944	55.56	87.31	17.46	—	CORT	18614	57.15	66.68	4.76	—	I4BA	22547	57.15	80.96	12.70	—	I5BB
17803	55.56	87.31	22.23	—	I13	18075	57.15	70.64	9.53	—	I4	15460	57.15	80.96	12.70	—	I5C
15905	55.56	88.90	6.35	—	F	25363	57.15	72.23	12.70	—	I5B.	15871	57.15	80.96	15.88	—	I3B.
19060	55.56	88.90	11.11	—	I5B.	12642	57.15	73.03	7.94	—	I2BA	15871	57.15	80.96	15.88	—	I3C
12515	55.56	88.90	12.70	—	I2B.	12592	57.15	73.03	7.94	—	I5BA	11555	57.15	80.96	17.46	—	I5BA
19894	55.56	90.09	9.53	—	I5B.	15725	57.15	73.03	9.53	—	CORT	15958	57.15	82.55	6.35	—	I4BA
17674	55.56	90.49	14.29	—	I13	16658	57.15	73.03	11.11	—	I5B.	15958	57.15	82.55	6.35	—	I4C
17522	55.56	92.08	11.91	—	I5B.	18113	57.15	73.03	12.70	—	F	15958	57.15	82.55	6.35	—	I4BA
15631	55.56	95.25	7.94	—	F	14775	57.15	74.61	4.76	—	ESPE	12595	57.15	82.55	7.94	—	I5BB
15748	55.56	100.40	6.36	—	ESPE	14678	57.15	74.61	9.53	—	I5BB	12595	57.15	82.55	7.94	—	I5BB
25329	55.56	101.60	9.92	—	I5BA	17870	57.15	74.61	9.53	—	ESPE	17871	57.15	82.55	9.53	—	I5BA
15429	55.56	119.10	19.84	—	I55	14678	57.15	74.61	9.53	—	I5BB	12652	57.15	82.55	9.53	—	I2BA
15231	55.56	120.70	13.49	—	I55	18615	57.15	76.20	6.35	—	I5BA	15469	57.15	82.55	9.53	—	F
17368	55.56	120.70	20.64	—	I55	16346	57.15	76.20	7.50	—	I2BA	17871	57.15	82.55	9.53	—	I5BA
15425	55.56	125.40	19.84	—	I55	17678	57.15	76.20	9.53	—	F	17871	57.15	82.55	9.53	—	I5BA
15837	55.56	127.00	26.99	—	I55C	12215	57.15	76.20	9.53	—	I4BA	12652	57.15	82.55	9.53	—	I2BA
15614	55.56	136.50	12.70	22.23	I55	19942	57.15	76.20	9.53	—	I2BA	17871	57.15	82.55	9.53	—	I5BA
15122	55.56	146.80	26.19	—	I55	13289	57.15	76.20	9.53	—	I5BB	15210	57.15	82.55	12.70	—	I5BA
17705	55.56	163.50	17.45	—	I55	13289	57.15	76.20	9.53	—	I5BA	15587	57.15	82.55	12.70	—	I13
13945	55.60	76.20	11.00	—	I5BB	12013	57.15	76.20	9.53	—	I2BB	15210	57.15	82.55	12.70	—	I5BB
12174	55.76	70.00	13.00	—	I5B.	19942	57.15	76.20	9.53	—	I2BB	15210	57.15	82.55	12.70	—	I5B.
15748	55.96	100.40	6.35	—	I80	13289	57.15	76.20	9.53	—	I5BB	15210	57.15	82.55	12.70	—	I5B.
16435	56.00	66.00	7.00	—	I5BB	12643	57.15	76.20	11.11	—	I2BA	15210	57.15	82.55	12.70	—	I5C
25330	56.00	70.00	8.00	—	I5BB	12643	57.15	76.20	11.11	—	I2BA	15210	57.15	82.55	12.70	—	I5BA
25331	56.00	72.00	8.00	—	I5BB	17177	57.15	76.20	11.11	—	ESPE	15191	57.15	82.55	16.67	—	I3BC
RU37	56.00	72.00	8.00	—	I5B.	15186	57.15	76.20	12.70	—	I5BB	14067	57.15	82.55	17.46	—	I3BC
25331	56.00	72.00	8.00	—	I5BA	13531	57.15	76.20	12.70	—	I2BB	14067	57.15	82.55	17.46	—	I3C
16811	56.00	75.00	12.00	—	I5BB	13531	57.15	76.20	12.70	—	I2BB	17158	57.15	82.55	19.05	—	I1FB
16644	56.00	76.10	12.70	—	I5B.	15186	57.15	76.20	12.70	—	I5B.	17158	57.15	82.55	19.05	—	I1FB
25332	56.00	78.00	13.00	—	I5B.	13531	57.15	76.20	12.70	—	I2BB	15547	57.15	82.55	22.23	—	I1
25333	56.00	80.00	8.00	—	I5BB	15186	57.15	76.20	12.70	—	I5BB	13532	57.15	84.14	7.94	—	I5BA
25334	56.00	80.00	10.00	—	I5B.	25388	57.15	76.20	12.70	—	I5B.	13532	57.15	84.14	7.94	—	I5BB
25335	56.00	80.00	12.00	—	I5BB	13531	57.15	76.20	12.70	—	I2BA	22551	57.15	84.14	7.94	—	I5BA
16935	56.00	80.00	13.00	—	I5B.	14036	57.15	76.20	12.70	—	I3BA	15023	57.15	84.14	8.00	—	I4C
11587	56.00	83.00	10.00	—	I5BA	15186	57.15	76.20	12.70	—	I5C	15023	57.15	84.14	9.53	—	I4BA
12478	56.00	85.00	6.00	—	I5BB	14036	57.15	76.20	12.70	—	I3BC	15023	57.15	84.14	9.53	—	I4B.
25336	56.00	85.00	8.00	—	I5BB	13531	57.15	76.20	12.70	—	I2BB	14847	57.15	84.14	9.53	—	I80B
12391	56.00	85.00	13.00	—	I5BB	13531	57.15	76.20	12.70	—	I2BB	12911	57.15	84.14	9.53	—	I5BB
12391	56.00	85.00	13.00	—	I5BB	15776	57.15	76.20	17.46	—	I7BA	22552	57.15	84.93	9.53	—	I5BA
25337	56.00	85.00	13.00	—	I5B.	13529	57.15	76.20	19.05	—	I2BB	16877	57.15	84.93	11.91	—	I5B.
25340	56.00	90.00	13.00	—	I5B.	25398	57.15	76.20	19.05	—	I2BB	22553	57.15	84.93	11.91	—	I2BA
20241	56.00	100.00	10.00	—	I5BB	15588	57.15	76.20	19.05	—	I1BF	15135	57.15	84.93	12.70	—	I5B
20241	56.00	100.00	10.00	—	I5B.	15588	57.15	76.20	19.05	—	I1FC	15135	57.15	84.93	12.70	—	I5B.
15725	56.36	73.03	9.53	—	CORT	12200	57.15	77.79	6.35	—	I4B.	15135	57.15	84.93	12.70	—	I5BB
25341	56.36	84.93	11.91	—	I5B.	15201	57.15	77.79	11.11	—	I5BB	15135	57.15	84.93	12.70	—	I5BA
20218	56.75	81.36	18.28	—	I1FB	15535	57.15	77.79	11.11	—	I13	15135	57.15	84.93	12.70	—	I5B.
18925	57.00	69.80	6.40	—	I5BA	15201	57.15	77.79	11.11	—	I5BB	15135	57.15	84.93	12.70	—	I5C
13763	57.00	70.00	12.00	—	I5BA	13292	57.15	77.79	11.11	—	I2BB	17102	57.15	84.93	15.08	—	I2
20139	57.00	72.00	10.00	—	I5B.	13292	57.15	77.79	11.11	—	I2BA	17130	57.15	84.93	19.05	—	I1FC
25342	57.00	74.00	10.00	—	I5B.	13292	57.15	77.79	11.11	—	I2B.	15678	57.15	84.93	23.81	—	I9C
13985	57.00	75.00	9.00	—	I5BB	13292	57.15	77.79	11.11	—	I2BB	16892	57.15	85.09	11.88	—	I2B.
25343	57.00	75.00	10.00	—	I5BB	15201	57.15	77.79	11.11	—	I5B.	15771	57.15	85.33	12.70	—	I5C
25344	57.00	80.00	12.00	—	I5B.	22541	57.15	77.79	11.91	—	I5B.	15771	57.15	85.33	12.70	—	I5C
14484	57.00	80.00	13.00	—	I5B.	22542	57.15	77.79	12.70	—	I5B.	15771	57.15	85.33	12.70	—	I5BA
25345	57.00	80.00	13.00	—	I5B.	22543	57.15	77.79	19.05	—	I2BA	20117	57.15	85.73	9.53	—	I5BB
20090	57.00	82.00	12.00	—	I5BA	18616	57.15	79.38	6.35	—	I4	17441	57.15	85.73	11.90	—	I5BB
25346	57.00	83.00	12.00	—	I5BA	22544	57.15	79.38	9.53	—	I5BA	17441	57.15	85.73	11.91	—	I5BA
17441	57.00	85.00	11.00	—	I5BB	22545	57.15	79.38	9.53	—	I2BA	17767	57.15	85.73	12.70	—	F
25347	57.00	85.00	12.00	—	I5B.	16244	57.15	79.38	11.11	—	I5BA	22557	57.15	85.73	12.70	—	I5BB
13764	57.00	85.00	14.00	—	I5BA	17134	57.15	79.38	12.70	—	I5B.	22559	57.15	85.73	13.49	—	I2BB
25348	57.00	89.00	14.00	—	I5B.	17134	57.15	79.38	12.70	—	I5B.	13340	57.15	85.73	15.88	—	I2BB
—	57.00	89.00	14.00	—	I5B.	15848	57.15	79.38	12.70	—	I13	15785	57.15	85.73	15.88	—	I12C
14485	57.00	90.00	12.00	—	I5BB	17134	57.15	79.38	12.70	—	I5C	17305	57.15	85.73	17.46	—	I1FC
14485	57.00	90.00	12.00	—	I5B.	22546	57.15	79.38	17.46	—	I2B.	22561	57.15	87.31	11.11	—	I5BA
22535	57.00	90.00	13.00	—	I5B.	18134	57.15	79.38	22.23	—	ESPE	15289	57.15	87.31	17.07	—	ESPE
22536	57.10	82.30	9.50	—	I5BA	19061	57.15	80.17	11.11	—	I5BB	17334	57.15	88.11	34.93	—	ESPE



# Retentores

Perfis - Ver Última Página



INCOVE VEDAÇÕES LTDA.

Cod.	Di	De	Ha1	Ha2	Mod	Cod.	Di	De	Ha1	Ha2	Mod	Cod.	Di	De	Ha1	Ha2	Mod
12094	57.15	88.60	6.35	—	I4B	18935	57.54	99.20	6.40	—	ESPE	13215	58.00	94.00	13.00	—	ESPE
12095	57.15	88.90	6.35	—	I4B	18514	57.55	67.47	6.35	—	I4B.	14891	58.00	98.00	25.00	—	I9C
12093	57.15	88.90	9.53	—	I5B.	15752	57.55	106.40	6.35	—	ESPE	20310	58.50	78.00	10.00	—	I4BB
15022	57.15	88.90	9.53	—	I4BB	20192	57.80	80.00	9.50	—	I4BB	16705	58.70	89.03	25.40	—	I2B.
12673	57.15	88.90	9.53	—	I5BA	15446	57.94	80.17	9.53	—	I4BA	11335	58.70	91.50	9.80	—	I5B.
12673	57.15	88.90	9.53	—	I5BB	15446	57.94	80.17	9.53	—	I4C	18926	58.74	69.85	5.56	—	I4
15022	57.15	88.90	9.53	—	I4BA	15405	57.94	92.08	9.53	—	I4C	19064	58.74	76.20	9.53	—	I5BA
15022	57.15	88.90	9.53	—	ESPE	17247	57.94	108.00	8.73	—	I80	22589	58.74	76.20	11.11	—	I5BA
15248	57.15	88.90	12.70	—	I5BB	15749	57.94	112.70	6.35	—	I815	18997	58.74	77.79	7.14	—	I4BA
15248	57.15	88.90	12.70	—	I5BA	15724	57.94	130.20	24.61	—	ESPE	16857	58.74	77.79	7.17	—	I5BB
15248	57.15	88.90	12.70	—	I5B.	13807	58.00	68.00	10.00	—	I5BB	19065	58.74	77.79	11.11	—	I5BB
15248	57.15	88.90	12.70	—	I5C	11172	58.00	72.00	8.00	—	I2BA	12258	58.74	79.38	9.53	—	I5BB
16142	57.15	88.90	12.70	—	I2B.	14865	58.00	72.00	8.00	—	I5BB	12258	58.74	79.38	9.53	—	I5BB
15248	57.15	88.90	12.70	—	I5C	14865	58.00	72.00	8.00	—	I5BA	18046	58.74	79.38	11.91	—	N TE
17159	57.15	88.90	17.46	—	I12B	14865	58.00	72.00	8.00	—	I5B.	17790	58.74	79.38	12.70	—	I5BB
19937	57.15	88.90	20.64	—	I1BF	11172	58.00	72.00	8.00	—	I2BB	17137	58.74	79.38	17.46	—	I5B.
19937	57.15	88.90	20.64	—	I1FC	14735	58.00	72.00	12.00	—	I5BB	19066	58.74	80.17	11.11	—	I5BB
19063	57.15	90.09	11.11	—	I5BB	14735	58.00	72.00	12.00	—	I5BB	15538	58.74	80.96	19.05	—	ESPE
—	57.15	90.09	12.70	—	I5BB	22571	58.00	72.00	12.00	—	I2BB	22592	58.74	82.55	11.11	—	I5B.
17905	57.15	90.49	6.35	—	F	12393	58.00	75.00	8.00	—	I5BA	17205	58.74	82.55	12.70	—	I5B
15328	57.15	90.49	7.94	—	F	12393	58.00	75.00	8.00	—	I5BB	17205	58.74	82.55	12.70	—	I5BB
17987	57.15	90.49	19.05	—	I1FC	12653	58.00	75.00	9.00	—	I2BB	17205	58.74	82.55	12.70	—	I5BA
11277	57.15	92.08	9.53	—	I5B.	—	58.00	75.00	9.00	—	I2BB	17205	58.74	82.55	12.70	—	I5C
15003	57.15	92.08	11.11	—	F	12653	58.00	75.00	9.00	—	I2BB	17782	58.74	82.55	17.86	—	I12C
13445	57.15	92.08	11.11	—	I5B.	12653	58.00	75.00	9.00	—	I2BB	18620	58.74	82.55	19.05	—	I1
18297	57.15	92.08	12.70	—	I5B.	16069	58.00	75.00	10.00	—	I5BB	18621	58.74	84.14	9.53	—	I5BB
18297	57.15	92.08	12.70	—	I5C	14486	58.00	75.00	12.00	—	I5BA	18621	58.74	84.14	9.53	—	I5C
22564	57.15	92.08	17.86	—	I2B.	14486	58.00	75.00	12.00	—	I5BA	22594	58.74	84.14	12.70	—	I5B.
15255	57.15	92.18	17.85	—	I3BB	12651	58.00	75.00	12.00	—	I2BA	20317	58.74	84.14	12.70	—	I2BB
15607	57.15	95.25	9.13	—	I13	14486	58.00	75.00	12.00	—	I5B.	11794	58.74	84.28	11.90	—	I5B.
17647	57.15	95.25	12.70	—	I5BB	22575	58.00	75.00	12.00	—	I2BA	15902	58.74	84.93	7.94	—	I5BA
17519	57.15	95.25	15.88	—	I13	14486	58.00	75.00	12.00	—	I5BA	15902	58.74	84.93	7.94	—	I5BB
15391	57.15	95.25	20.64	—	I1	16801	58.00	76.00	6.50	—	I5BA	22595	58.74	84.93	7.94	—	I5B.
15230	57.15	95.65	17.46	—	I3	16086	58.00	76.20	9.00	—	I5BB	15484	58.74	84.93	11.91	—	I5C
22565	57.15	96.04	11.11	—	I5B.	20170	58.00	78.00	10.00	—	I5BB	15484	58.74	84.93	11.91	—	I5C
18018	57.15	96.04	11.11	—	ESPE	20170	58.00	78.00	10.00	—	I5B.	17422	58.74	84.93	16.67	—	I1
22567	57.15	96.85	6.35	—	I5BA	22576	58.00	78.00	13.00	—	I5B.	13069	58.74	85.73	9.53	—	I5BB
17992	57.15	97.31	6.35	—	I4	12479	58.00	80.00	8.00	—	I5BB	22597	58.74	85.73	11.11	—	I5B.
17855	57.15	98.43	4.76	—	F	11316	58.00	80.00	8.00	—	I2BB	18622	58.74	85.73	11.91	—	I5BB
22568	57.15	98.43	11.91	—	I5B.	16864	58.00	80.00	10.00	—	I2BB	18622	58.74	85.73	11.91	—	I5BA
17173	57.15	98.43	12.70	—	I5B.	11211	58.00	80.00	10.00	—	I5BB	22598	58.74	85.73	12.70	—	I5B.
17935	57.15	99.22	6.35	—	I815	11211	58.00	80.00	10.00	—	I5BA	12394	58.74	85.73	12.70	—	I5B.
14679	57.15	100.00	12.70	—	I5C	11211	58.00	80.00	10.00	—	I2BB	13173	58.74	85.73	17.46	—	ESPE
15792	57.15	101.60	11.91	—	I5B.	11211	58.00	80.00	10.00	—	I5C	13173	58.74	85.73	17.46	—	I1FC
15988	57.15	101.60	20.64	—	I3B.	11211	58.00	80.00	10.00	—	I2BB	19067	58.74	87.31	11.11	—	I5B.
15404	57.15	101.60	20.64	—	I1BF	11800	58.00	80.00	12.00	—	I2BB	15880	58.74	88.90	7.94	—	F
15404	57.15	101.60	20.64	—	I1FC	22580	58.00	80.00	12.00	—	I5B.	18623	58.74	88.90	12.70	—	I5B.
18618	57.15	104.80	14.29	—	I5B.	11800	58.00	80.00	12.00	—	I2BB	11908	58.74	88.90	25.40	—	I5BB
17172	57.15	104.80	17.46	—	I1BF	22579	58.00	80.00	12.00	—	I5BB	22599	58.74	88.90	25.40	—	I5B.
17628	57.15	111.10	20.64	—	I1	14488	58.00	80.00	13.00	—	I5B.	16705	58.74	88.90	25.40	—	I2BA
18936	57.15	111.90	6.35	—	I815	14488	58.00	80.00	13.00	—	I5BB	18024	58.74	88.90	25.40	—	I9C
18093	57.15	112.70	20.64	—	I1FC	14488	58.00	80.00	13.00	—	I5B.	16705	58.74	89.03	25.40	—	I2B.
18093	57.15	112.70	20.64	—	I1BF	22581	58.00	80.00	13.00	—	I2B.	18624	58.74	90.09	9.53	—	I5BB
18619	57.15	120.70	15.88	—	I5B.	22582	58.00	82.00	9.50	—	I5BA	15603	58.74	90.49	12.70	—	F
15367	57.15	123.80	17.46	—	ESPE	—	58.00	82.00	9.50	—	I2BA	19068	58.74	92.08	11.11	—	I5BA
15425	57.15	125.40	19.84	—	I5C	16407	58.00	83.00	13.00	—	I5BB	22600	58.74	92.08	11.11	—	I5B.
17279	57.15	127.00	43.66	—	ESPE	22459	58.00	84.00	9.50	—	I2BA	22601	58.74	92.08	12.70	—	I2BB
17280	57.15	127.00	62.71	—	ESPE	12477	58.00	85.00	8.00	—	I5BB	15607	58.74	95.25	9.13	—	I13
17365	57.15	133.40	22.23	—	ESPE	22584	58.00	85.00	10.00	—	I5B.	18625	58.74	95.25	12.70	—	I5B
15490	57.15	171.50	38.10	—	I1FC	13338	58.00	85.00	13.00	—	I2BA	19069	58.74	98.43	11.11	—	I5B.
19062	57.16	87.31	11.11	—	I5B.	22586	58.00	85.00	13.00	—	I5B.	18626	58.74	101.60	11.91	—	I5B.
22569	57.20	76.00	12.70	—	I2BA	13338	58.00	85.00	13.00	—	I2BA	15429	58.74	119.10	20.24	—	I5C
—	57.20	77.75	10.00	—	I2BB	13936	58.00	90.00	12.00	—	I5BB	15367	58.74	123.80	17.46	—	I5C
15460	57.20	80.00	12.70	—	I5B.	—	58.00	90.00	13.00	—	I5B.	15724	58.74	130.20	24.61	—	ESPE
—	57.20	82.50	9.50	—	I5BA	13936	58.00	90.00	13.00	—	I5BB	15599	58.74	134.90	48.82	—	I3
16874	57.20	82.80	14.00	—	ESPE	16698	58.00	90.60	9.60	—	I5BB	16606	58.80	78.10	7.20	—	I5BB
15255	57.20	92.00	18.00	—	I2B.	22534	58.00	92.00	13.00	—	I5BB	16840	59.00	71.30	9.50	—	I5BA



# Retentores

Perfis - Ver Última Página



INCOVE VEDAÇÕES LTDA.

Cod.	Di	De	Ha1	Ha2	Mod	Cod.	Di	De	Ha1	Ha2	Mod	Cod.	Di	De	Ha1	Ha2	Mod
20039	59.00	76.20	13.00	—	15BB	11170	60.00	78.25	8.80	—	15BB	20413	60.00	85.00	14.00	—	15B.
12033	59.00	78.00	12.00	—	15BA	22619	60.00	79.00	13.00	—	15BB	11393	60.00	85.00	15.00	—	15B.
22602	59.00	79.00	9.00	—	15BB	11110	60.00	80.00	8.00	—	12BB	11564	60.00	86.00	12.00	—	15BB
12315	59.00	79.70	9.70	11.80	ESPE	11110	60.00	80.00	8.00	—	15BA	12602	60.00	89.00	18.00	—	12B
22603	59.00	80.00	10.00	—	15BB	11096	60.00	80.00	8.50	—	15BB	12602	60.00	89.00	18.00	—	12B.
22521	59.00	100.00	8.00	—	14BB	11096	60.00	80.00	8.50	—	15BB	12602	60.00	89.00	18.00	—	12B.
15852	59.13	80.96	11.91	—	113	14492	60.00	80.00	10.00	—	15BB	14496	60.00	90.00	7.00	—	14BA
16907	59.50	78.00	7.10	—	14BA	14492	60.00	80.00	10.00	—	15BB	22631	60.00	90.00	8.00	—	15BB
17127	59.50	85.60	12.00	—	15B.	14492	60.00	80.00	10.00	—	15BB	22631	60.00	90.00	8.00	—	15BA
17127	59.50	85.60	12.00	—	15C	14492	60.00	80.00	10.00	—	15BB	14497	60.00	90.00	10.00	—	15BB
17327	59.53	76.20	12.70	—	15BB	14492	60.00	80.00	10.00	—	15BB	14497	60.00	90.00	10.00	—	15BA
22605	59.53	82.55	22.23	—	12BA	14492	60.00	80.00	10.00	—	15BA	14497	60.00	90.00	10.00	—	15B.
17607	59.53	84.93	11.91	—	15C	14492	60.00	80.00	10.00	—	15B.	11436	60.00	90.00	10.00	—	12BB
17645	59.53	85.73	11.91	—	15B.	11103	60.00	80.00	10.00	—	12BB	11436	60.00	90.00	10.00	—	12BA
22606	59.53	85.73	12.30	—	15B.	14492	60.00	80.00	10.00	—	15BA	12583	60.00	90.00	12.00	—	15BA
22607	59.53	85.73	12.70	—	12BA	14492	60.00	80.00	10.00	—	15BB	22632	60.00	90.00	12.00	—	12B.
11354	59.53	85.73	17.46	—	12BB	14492	60.00	80.00	10.00	—	15BB	14498	60.00	90.00	13.00	—	15BB
11378	59.80	75.00	9.00	—	12BB	22622	60.00	80.00	11.00	—	15BA	14498	60.00	90.00	13.00	—	15BA
11378	59.80	75.00	9.00	—	15BB	22623	60.00	80.00	11.00	—	12B.	14498	60.00	90.00	13.00	—	15B.
16395	60.00	70.00	7.00	—	14BB	14872	60.00	80.00	12.00	—	12BA	16343	60.00	90.00	13.00	—	12BA
16741	60.00	70.00	7.00	—	15BA	12395	60.00	80.00	12.00	—	15BB	14498	60.00	90.00	13.00	—	15C
22608	60.00	70.00	8.00	—	15BA	12395	60.00	80.00	12.00	—	12BA	16427	60.00	90.00	14.00	—	15JM
22609	60.00	70.00	10.00	—	15BA	12395	60.00	80.00	12.00	—	15BB	16427	60.00	90.00	14.00	—	15BA
20226	60.00	70.00	10.00	—	12BB	14872	60.00	80.00	12.00	—	12BB	11444	60.00	90.00	16.00	—	15BB
22610	60.00	71.00	8.00	—	15BA	14872	60.00	80.00	12.00	—	12BA	16992	60.00	95.00	10.00	—	15BB
11899	60.00	72.00	4.00	—	14BA	12395	60.00	80.00	12.00	—	15BB	22636	60.00	95.00	13.00	—	15B.
16873	60.00	72.00	6.00	—	14BB	12395	60.00	80.00	12.00	—	15B.	12950	60.00	95.00	19.00	—	ESPE
11460	60.00	72.00	8.00	—	15BB	13939	60.00	80.00	12.00	—	112B	16098	60.00	100.00	6.00	—	15BB
13991	60.00	72.00	10.00	—	15BB	13116	60.00	80.00	12.70	—	ESPE	22637	60.00	100.00	10.00	—	15B.
22611	60.00	72.00	10.00	—	15BA	14493	60.00	80.00	13.00	—	15BB	11939	60.00	100.00	13.00	—	15BB
18284	60.00	72.00	18.00	—	15BB	14493	60.00	80.00	13.00	—	15B.	11939	60.00	100.00	13.00	—	15BA
11000	60.00	74.00	7.00	—	15BB	14493	60.00	80.00	13.00	—	15BB	20238	60.00	110.00	12.00	—	15BB
11000	60.00	74.00	7.00	—	15BB	22624	60.00	80.00	13.00	—	15BB	20238	60.00	110.00	12.00	—	15BB
16361	60.00	74.00	10.00	—	15BB	13243	60.00	80.00	13.00	—	12BA	22640	60.00	110.00	13.00	—	15BB
12335	60.00	75.00	5.00	—	ESPE	11993	60.00	80.00	70.00	—	12BB	22641	60.00	111.00	12.00	—	15BA
22612	60.00	75.00	6.00	—	12BB	22620	60.00	80.50	7.00	—	15BB	16357	60.00	135.00	13.00	—	12B.
11100	60.00	75.00	8.00	—	12BB	13658	60.00	81.00	7.00	—	15BA	11847	60.00	300.00	40.00	—	TDUO
14489	60.00	75.00	8.00	—	15BB	16090	60.00	81.00	12.00	—	15B.	15914	60.20	149.50	11.50	—	ESPE
16557	60.00	75.00	8.00	—	14BB	16744	60.00	82.00	6.00	—	15BB	15914	60.20	149.50	11.50	—	ESPE
14489	60.00	75.00	8.00	—	15BB	25354	60.00	82.00	8.00	—	15BB	16309	60.25	77.80	11.11	—	12BB
14489	60.00	75.00	8.00	—	15B	20277	60.00	82.00	9.50	—	12BB	11841	60.30	85.75	23.80	—	17BA
14489	60.00	75.00	8.00	—	15BA	12109	60.00	82.00	12.00	—	12BB	12397	60.30	88.40	11.00	—	15BB
14489	60.00	75.00	8.00	—	15BA	12109	60.00	82.00	12.00	—	12BB	12397	60.30	88.40	11.00	—	15B.
11100	60.00	75.00	8.00	—	12BB	14494	60.00	82.00	12.00	—	15BB	12397	60.30	88.40	11.00	—	15C
11100	60.00	75.00	8.00	—	12BB	14494	60.00	82.00	12.00	—	15BB	15011	60.30	91.40	6.40	15.30	ESPE
14489	60.00	75.00	8.00	—	15BB	14494	60.00	82.00	12.00	—	15BA	15914	60.30	149.40	8.30	—	ESPE
11100	60.00	75.00	8.00	—	12BB	22625	60.00	82.00	12.00	—	12BB	.....	60.30	155.50	8.00	—	ESPE
22613	60.00	75.00	9.00	—	12BB	14494	60.00	82.00	12.00	—	15BB	17330	60.33	73.03	12.70	—	N TE
11059	60.00	75.00	10.00	—	15BA	16448	60.00	82.00	13.00	—	12BA	16616	60.33	76.20	6.35	—	15BB
11059	60.00	75.00	10.00	—	15BB	11927	60.00	82.20	12.00	—	12BB	18023	60.33	76.20	9.53	—	15BA
16475	60.00	75.00	10.00	—	12BB	11752	60.00	83.00	9.00	—	12BB	15944	60.33	76.20	11.11	—	1/2
16475	60.00	75.00	10.00	—	12BB	12454	60.00	83.00	12.00	—	15B.	22642	60.33	76.20	19.05	—	15BA
17049	60.00	75.00	12.00	—	1/2	16260	60.00	83.00	13.00	—	15BB	17505	60.33	76.99	6.35	—	N TE
16088	60.00	75.00	12.00	—	15BB	11295	60.00	84.00	10.00	—	15B.	22643	60.33	77.79	11.11	—	15B.
16088	60.00	75.00	12.00	—	15BA	14495	60.00	85.00	6.00	—	15BA	18043	60.33	77.79	11.91	—	1/2
20223	60.00	76.00	7.00	—	15BB	20145	60.00	85.00	7.00	—	14	17760	60.33	77.79	12.70	—	15BB
14490	60.00	77.00	10.00	—	15BA	22626	60.00	85.00	8.00	—	15BB	17760	60.33	77.79	12.70	—	15BA
25449	60.00	78.00	9.00	—	15BB	11246	60.00	85.00	8.00	—	12BB	22644	60.33	77.79	12.70	—	12BB
13088	60.00	78.00	9.00	—	12BB	22627	60.00	85.00	9.00	—	15BB	17760	60.33	77.79	12.70	—	15C
13088	60.00	78.00	9.00	—	12BA	11010	60.00	85.00	10.00	—	15BB	15879	60.33	79.38	7.94	—	F
13088	60.00	78.00	9.00	—	12BA	11010	60.00	85.00	10.00	—	15BA	22645	60.33	79.38	7.94	—	15BB
22615	60.00	78.00	9.00	—	12BA	11010	60.00	85.00	10.00	—	15B.	13420	60.33	79.38	9.53	—	15BB
25418	60.00	78.00	9.50	—	15BA	16347	60.00	85.00	10.00	—	12BA	13420	60.33	79.38	9.53	—	15BB
11447	60.00	78.00	10.00	—	15BB	11490	60.00	85.00	12.00	—	15B	12647	60.33	79.38	9.53	—	12BA
14491	60.00	78.00	12.00	—	15BA	11490	60.00	85.00	12.00	—	15BB	13420	60.33	79.38	9.53	—	15BB
22618	60.00	78.00	13.00	—	15B.	22629	60.00	85.00	13.00	—	15BB	22646	60.33	79.38	9.53	—	15BB
11170	60.00	78.25	8.80	—	15BA	22630	60.00	85.00	13.00	—	12B.	12647	60.33	79.38	9.53	—	12BB



# Retentores

Perfis - Ver Última Página



INCOVE VEDAÇÕES LTDA.

Cod.	Di	De	Ha1	Ha2	Mod	Cod.	Di	De	Ha1	Ha2	Mod	Cod.	Di	De	Ha1	Ha2	Mod
17806	60.33	79.38	11.11	—	I5B.	22664	60.33	88.50	11.11	—	I5BB	15914	60.33	148.40	12.70	—	ESPE
22647	60.33	79.38	11.91	—	I2BA	22665	60.33	88.50	12.70	—	I5B.	12966	60.33	154.00	11.11	—	DISC
16239	60.33	79.38	12.00	—	I2BA	22666	60.33	88.50	12.70	—	I2BB	—	60.40	79.40	9.30	—	I2BB
13421	60.33	79.38	12.70	—	I5B.	15010	60.33	88.50	12.70	—	I5C	22479	60.50	78.00	9.50	—	I2BB
22648	60.33	79.38	12.70	—	I2B.	17283	60.33	88.50	17.46	—	I3B.	12632	60.50	88.50	13.00	—	I5B.
13421	60.33	79.38	12.70	—	I5C	22667	60.33	88.50	17.46	—	I2B.	18915	60.72	112.30	6.35	—	I815
17356	60.33	79.38	15.88	—	I3	18033	60.33	88.50	17.46	—	I2B.	17620	60.80	66.68	12.70	—	I5C
19076	60.33	80.17	11.11	—	I5BB	18630	60.33	88.90	6.35	—	I4	13765	61.00	72.00	13.00	—	I5BA
17641	60.33	80.96	7.94	—	F	17792	60.33	88.90	9.53	—	I5B.	22683	61.00	75.00	8.00	—	I5BA
16023	60.33	80.96	7.94	—	I5B.	17191	60.33	88.90	9.53	—	F	22684	61.00	85.00	7.00	—	I5BB
22649	60.33	80.96	11.91	—	I5B.	17792	60.33	88.90	9.53	—	I5C	22685	61.00	85.00	13.00	—	I5B.
15939	60.33	80.96	12.70	—	I5B.	13330	60.33	88.90	11.11	—	I2B.	13790	61.00	95.00	9.00	—	I5BB
22650	60.33	80.96	12.70	—	I2BA	22669	60.33	88.90	11.91	—	I5B.	22686	61.12	79.38	9.53	—	I5B.
15939	60.33	80.96	12.70	—	I5B.	22670	60.33	88.90	11.91	—	I2B.	15232	61.12	91.68	10.32	—	I13
19949	60.33	80.96	12.70	19.05	ESPE	15571	60.33	88.90	12.70	—	I5BB	22687	61.50	111.00	12.00	—	I5BA
15134	60.33	82.55	7.94	—	F	15571	60.33	88.90	12.70	—	I5B.	15898	61.68	85.33	11.11	—	I1FB
13029	60.33	82.55	9.53	—	I5B.	15571	60.33	88.90	12.70	—	I5B.	11614	61.91	76.20	6.50	—	I5BA
11062	60.33	82.55	9.53	—	I2BB	15571	60.33	88.90	12.70	—	I5C	18186	61.91	76.20	7.94	—	I4B.
11062	60.33	82.55	9.53	—	I2B.	18991	60.33	88.90	15.88	—	I1BF	19959	61.91	79.38	3.18	—	I4BA
11062	60.33	82.55	9.53	—	I2BA	17203	60.33	88.90	15.88	—	I3B.	12398	61.91	79.38	9.53	—	I5B.
16206	60.33	82.55	11.11	—	I5BA	12602	60.33	88.90	17.46	—	I2B.	17003	61.91	79.38	12.70	—	I5BA
17011	60.33	82.55	12.70	—	I5JM	18201	60.33	88.90	19.05	—	I7B.	17003	61.91	79.38	12.70	—	I5B.
17011	60.33	82.55	12.70	—	I5B	14065	60.33	88.90	19.05	—	I1BF	22689	61.91	79.38	12.70	—	I2B.
17011	60.33	82.55	12.70	—	I5BB	12566	60.33	90.09	12.70	—	I2BA	12255	61.91	80.17	9.92	—	I2B.
17011	60.33	82.55	12.70	—	I5C	17238	60.33	90.09	12.70	—	I5B.	19079	61.91	80.17	11.11	—	I5BA
18627	60.33	82.55	14.29	—	I2BA	12566	60.33	90.09	12.70	—	I2BA	15127	61.91	80.96	6.35	—	F
13172	60.33	84.14	12.70	—	I4BA	12566	60.33	90.09	12.70	—	I2B.	22691	61.91	80.96	9.53	—	I5BA
13172	60.33	84.14	12.70	—	I4BA	15789	60.33	90.09	15.88	—	I4C	19080	61.91	80.96	11.11	—	I5B.
16144	60.33	84.14	13.49	—	I5B.	13455	60.33	92.08	9.13	—	I5B.	17945	61.91	80.96	15.88	—	F
18628	60.33	84.93	6.35	—	I4BA	13880	60.33	92.08	9.53	—	I4BA	16539	61.91	82.50	12.70	—	I5B.
22651	60.33	84.93	6.35	—	I5BA	22672	60.33	92.08	11.91	—	I5B.	22692	61.91	82.55	11.91	—	I5BB
14697	60.33	84.93	9.53	—	I2BA	22673	60.33	92.08	11.91	—	I2BA	18635	61.91	82.55	12.70	—	I5BA
14697	60.33	84.93	9.53	—	I2BA	15458	60.33	92.08	12.00	—	I2BA	18635	61.91	82.55	12.70	—	I5B.
22653	60.33	84.93	11.91	—	I5BB	15458	60.33	92.08	12.00	18.50	ESPE	18634	61.91	82.55	19.05	—	I1BF
22655	60.33	84.93	12.70	—	I5BA	15458	60.33	92.08	12.00	—	I2BB	17100	61.91	84.93	9.53	—	I5B.
18629	60.33	84.93	15.88	—	I2	13319	60.33	92.08	12.00	—	I2B.	13110	61.91	84.93	11.11	—	I2B.
17872	60.33	84.93	19.05	—	I3	18632	60.33	92.08	12.70	—	I5B.	22694	61.91	84.93	11.91	—	I5BB
15120	60.33	85.21	11.10	—	I5BB	22446	60.33	92.08	15.08	—	I2BB	22693	61.91	84.93	11.91	—	I2B.
22656	60.33	85.33	9.53	—	I5BB	22674	60.33	92.08	15.08	—	I2BB	22696	61.91	85.73	9.53	—	I5B.
15120	60.33	85.33	11.91	—	I5B	22675	60.33	92.08	16.67	—	I2B.	18636	61.91	85.73	11.91	—	I5BB
15120	60.33	85.33	11.91	—	I5B.	15458	60.33	92.08	17.46	—	I3BB	12399	61.91	85.73	11.91	—	I2B.
15120	60.33	85.33	11.91	—	I5BB	15458	60.33	92.08	17.46	—	I3BC	18277	61.91	85.73	12.70	—	I5BA
15120	60.33	85.33	11.91	—	I5BA	15458	60.33	92.08	17.46	—	I3B.	18636	61.91	85.73	12.70	—	I5B.
22657	60.33	85.33	12.30	—	I2B.	15458	60.33	92.08	17.46	—	I3C	22697	61.91	87.31	9.53	—	I2BA
12396	60.33	85.33	12.70	—	I5BB	22676	60.33	92.08	17.86	—	I2B.	17954	61.91	88.50	12.70	—	I5BA
22658	60.33	85.33	12.70	—	I5BB	20271	60.33	92.55	9.53	—	I2BA	17954	61.91	88.50	12.70	—	I5B.
15041	60.33	85.33	15.08	—	ESPE	15985	60.33	95.25	6.35	—	I4	13647	61.91	88.90	9.53	—	I5BA
15041	60.33	85.33	15.08	—	I3BC	12715	60.33	95.25	11.11	—	I5B.	22699	61.91	88.90	9.53	—	I5B.
15041	60.33	85.33	15.08	—	I3C	15585	60.33	95.25	11.11	—	ESPE	17021	61.91	88.90	12.70	—	I5B.
16322	60.33	85.33	16.67	—	I5BA	18633	60.33	95.25	12.70	—	I5C	18084	61.91	89.50	18.05	—	I1FC
13253	60.33	85.33	16.67	—	I1FC	22677	60.33	98.43	6.35	—	I5BB	15643	61.91	90.09	12.70	—	I5B.
13213	60.33	85.73	9.53	—	I5BA	19077	60.33	98.43	11.11	—	I5B.	15643	61.91	90.09	12.70	—	I5C
13213	60.33	85.73	9.53	—	I5BA	15594	60.33	99.62	9.53	—	I13	18637	61.91	90.09	15.88	—	I2BA
11219	60.33	85.73	9.53	—	I4BA	15907	60.33	100.00	11.11	—	I5B.	15445	61.91	92.08	9.53	—	I4BA
22659	60.33	85.73	9.53	—	I5BB	15956	60.33	100.80	27.78	—	SANF	22700	61.91	92.08	9.53	—	I5BB
13213	60.33	85.73	9.53	—	I5BB	16723	60.33	101.60	10.32	—	I7BB	22701	61.91	92.08	9.53	—	I2BA
19971	60.33	85.73	9.53	—	I2BB	19078	60.33	101.60	11.11	—	I5B.	15445	61.91	92.08	9.53	—	I4C
19971	60.33	85.73	9.53	—	I2B.	17355	60.33	111.10	15.88	—	I5B.	18638	61.91	92.08	15.88	—	I5B.
22660	60.33	85.73	11.11	—	I5B.	22679	60.33	111.13	11.11	—	I5B.	19081	61.91	95.25	11.11	—	I5BB
22661	60.33	85.73	11.51	—	I5BA	22680	60.33	111.13	12.70	—	I5B.	22702	61.91	95.25	11.11	—	I5B.
17127	60.33	85.73	12.70	—	I5BA	15475	60.33	112.70	20.64	—	I1FC	19082	61.91	98.43	11.11	—	I5B.
22662	60.33	85.73	12.70	—	I5B.	22681	60.33	112.71	9.53	—	I5BA	19083	61.91	101.60	11.11	—	I5B.
13721	60.33	85.73	12.70	—	I7BB	22682	60.33	114.30	24.61	—	I5BA	20031	62.00	68.70	9.40	—	ESPE
13105	60.33	85.73	22.23	—	I9BA	15367	60.33	123.80	17.46	—	ESPE	22703	62.00	72.00	6.00	—	I5BA
13105	60.33	85.75	22.80	—	I9B.	15425	60.33	125.40	19.45	—	ESPE	16194	62.00	72.00	10.00	—	I2BA
13105	60.33	85.75	22.80	—	I9B.	17065	60.33	127.00	17.46	—	I80F	12848	62.00	74.00	5.00	—	I5BB
17715	60.33	88.11	11.11	—	I5B.	15914	60.33	148.40	12.70	—	ESPE	16960	62.00	75.00	10.00	—	I4BB





# Retenfores

Perfis - Ver Última Página



INCOVE VEDAÇÕES LTDA.

Cod.	Di	De	Ha1	Ha2	Mod	Cod.	Di	De	Ha1	Ha2	Mod	Cod.	Di	De	Ha1	Ha2	Mod
11206	62.00	75.00	10.00	—	15BA	12400	63.00	81.20	10.00	—	15BA	.....	63.50	83.80	9.00	11.50	I2BA
20382	62.00	75.30	—	5.00	15BB	22719	63.00	83.00	8.00	—	15BB	15737	63.50	84.14	10.32	—	I13
12551	62.00	79.60	9.00	—	15BA	22720	63.00	85.00	8.00	—	15BB	17798	63.50	84.14	12.70	—	ESPE
22704	62.00	80.00	8.00	—	15BB	22722	63.00	85.00	10.00	—	15BB	13019	63.50	84.14	12.70	—	15B.
14500	62.00	80.00	8.00	—	15BB	22723	63.00	85.00	12.00	—	15B.	18642	63.50	84.93	6.35	—	I4
25387	62.00	80.00	10.00	—	15BB	13065	63.00	85.00	13.00	—	15B.	22734	63.50	84.93	9.54	—	15BB
13198	62.00	80.00	10.00	—	15B.	16237	63.00	89.00	13.00	—	15BB	22735	63.50	84.93	11.91	—	15BB
13198	62.00	80.00	10.00	—	15BB	16237	63.00	89.00	13.00	—	15B.	14076	63.50	85.73	7.94	—	1816
22705	62.00	80.00	10.00	—	15BA	22724	63.00	90.00	10.00	—	15BB	17026	63.50	85.73	9.53	—	15BB
13198	62.00	80.00	10.00	—	15B.	22725	63.00	90.00	10.00	—	12BB	22737	63.50	85.73	9.53	—	15BB
22706	62.00	80.00	10.00	—	12B.	22726	63.00	90.00	12.00	—	15B.	13353	63.50	85.73	12.70	—	12B
22707	62.00	80.00	12.00	—	15B.	16033	63.00	90.30	10.00	—	15BA	14474	63.50	85.73	12.70	—	15B.
14501	62.00	82.00	6.00	—	15BB	12747	63.00	92.00	10.00	—	15BA	13353	63.50	85.73	12.70	—	12BA
14501	62.00	82.00	6.00	—	15BB	22502	63.00	92.15	11.90	—	15B.	14474	63.50	85.73	12.70	—	15BB
16625	62.00	82.00	8.00	—	15BB	22728	63.00	94.00	7.00	—	15BB	14474	63.50	85.73	12.70	—	15B
23628	62.00	82.00	10.00	—	15BB	12546	63.00	105.00	10.00	—	15BB	13353	63.50	85.73	12.70	—	12B.
12513	62.00	82.00	16.00	—	15BA	15199	63.10	77.79	14.29	—	ESPE	14474	63.50	85.73	12.70	—	15BA
16333	62.00	85.00	8.00	—	12BB	12138	63.30	89.20	19.00	—	14BA	15153	63.50	86.12	11.91	—	15BA
22709	62.00	85.00	9.50	—	15B.	20166	63.30	92.20	19.00	—	14BA	15153	63.50	86.12	11.91	—	15B.
22708	62.00	85.00	9.50	—	12B.	18166	63.50	63.50	4.76	—	F	15153	63.50	86.12	11.91	—	15BA
14502	62.00	85.00	10.00	—	15BB	11016	63.50	73.03	6.35	—	15BA	15153	63.50	86.12	11.91	—	15C
14502	62.00	85.00	10.00	—	15BB	18639	63.50	76.20	6.35	—	14BA	22738	63.50	86.52	12.70	—	15BB
14502	62.00	85.00	10.00	—	15BB	12886	63.50	76.20	7.00	—	12BA	22426	63.50	87.19	9.50	—	12BA
14502	62.00	85.00	10.00	—	15BA	22729	63.50	76.20	7.14	—	15B.	15257	63.50	87.31	7.94	—	12BA
14502	62.00	85.00	10.00	—	15BB	15775	63.50	76.20	7.50	—	14BA	12027	63.50	88.00	10.00	—	15BB
22710	62.00	85.00	12.00	—	15B.	12548	63.50	76.20	7.94	—	14B.	14841	63.50	88.11	9.53	—	15BB
16240	62.00	85.00	12.00	—	12BB	12906	63.50	76.20	7.94	—	15B.	17418	63.50	88.90	4.76	—	F
14503	62.00	85.00	13.00	—	15BB	16803	63.50	76.20	7.94	—	14T	18643	63.50	88.90	6.35	—	I4
14503	62.00	85.00	13.00	—	15BB	15663	63.50	76.20	9.50	—	15BB	22739	63.50	88.90	7.14	—	15B.
14503	62.00	85.00	13.00	—	15B.	15663	63.50	76.20	9.53	—	15BB	18998	63.50	88.90	7.94	—	14B.
14503	62.00	85.00	13.00	—	15B.	15663	63.50	76.20	9.53	—	15BB	22741	63.50	88.90	9.53	—	15B.
14503	62.00	85.00	13.00	—	15C	11271	63.50	76.20	12.70	—	17BA	19902	63.50	88.90	9.53	—	1550
13096	62.00	87.00	13.00	—	15BB	11833	63.50	76.20	13.00	—	12B.	16639	63.50	88.90	9.92	—	12BB
14504	62.00	90.00	8.00	—	15B.	25383	63.50	77.00	9.10	—	12BB	—	63.50	88.90	11.00	—	12BB
14505	62.00	90.00	10.00	—	15BB	11320	63.50	79.38	6.35	—	12BA	13273	63.50	88.90	11.11	—	15BA
14505	62.00	90.00	10.00	—	15B	22730	63.50	79.38	7.94	—	15BB	13273	63.50	88.90	11.11	—	15B.
16117	62.00	90.00	10.00	—	12BB	17018	63.50	79.38	11.11	—	180J	12403	63.50	88.90	11.11	—	12B.
14505	62.00	90.00	10.00	—	15BB	19224	63.50	79.38	12.70	—	15JM	13273	63.50	88.90	11.11	—	15B.
14505	62.00	90.00	10.00	—	15BB	19224	63.50	79.38	12.70	—	15B.	22205	63.50	88.90	11.91	—	15BB
22713	62.00	90.00	12.00	—	15B.	18237	63.50	80.17	7.94	—	15B.	12401	63.50	88.90	12.70	—	12BA
14506	62.00	90.00	13.00	—	15BB	18237	63.50	80.17	7.94	—	15C	15111	63.50	88.90	12.70	—	15C
14506	62.00	90.00	13.00	—	15BB	12751	63.50	80.96	9.53	—	15BA	15111	63.50	88.90	12.70	—	15BA
14506	62.00	90.00	13.00	—	15BA	18640	63.50	80.96	11.11	—	15B.	12401	63.50	88.90	12.70	—	12BA
14506	62.00	90.00	13.00	—	15B.	18640	63.50	80.96	11.11	—	15C	15111	63.50	88.90	12.70	—	15JM
16121	62.00	90.00	13.00	—	12BA	11422	63.50	80.96	12.70	—	15C	15111	63.50	88.90	12.70	—	15BB
14507	62.00	90.00	15.00	—	11BF	18015	63.50	80.96	19.05	—	17B.	15111	63.50	88.90	12.70	—	15BB
13735	62.00	92.00	13.50	—	15B.	19970	63.50	81.76	12.70	—	14BA	15111	63.50	88.90	12.70	—	15BA
22714	62.00	95.00	10.00	—	15BB	13617	63.50	82.55	5.56	—	14BA	15111	63.50	88.90	12.70	—	15B.
11035	62.00	95.00	12.70	—	15BB	15316	63.50	82.55	7.94	—	F	12401	63.50	88.90	12.70	—	12BB
22715	62.00	100.00	10.00	—	15BB	18111	63.50	82.55	9.53	—	15BB	15111	63.50	88.90	12.70	—	15B.
14508	62.00	100.00	12.00	—	15BB	18111	63.50	82.55	9.53	—	15BA	15111	63.50	88.90	12.70	—	15C
14508	62.00	100.00	12.00	—	15B.	18111	63.50	82.55	9.53	—	15BA	15999	63.50	88.90	13.49	—	13B.
22716	62.00	100.00	13.00	—	15B.	12787	63.50	82.55	9.53	—	12BB	22743	63.50	88.90	13.49	—	12BA
13503	62.00	100.00	17.00	—	15BA	12787	63.50	82.55	9.53	—	12BA	15999	63.50	88.90	13.49	—	13BC
13503	62.00	100.00	17.00	—	15BA	12787	63.50	82.55	9.53	—	12B.	16325	63.50	88.90	13.70	—	15BB
22717	62.00	110.00	12.00	—	15BB	18111	63.50	82.55	9.53	—	15B.	16325	63.50	88.90	13.70	—	12BB
17807	62.71	77.79	11.11	—	15BA	12787	63.50	82.55	9.53	—	12BB	22745	63.50	88.90	15.08	—	12B.
17333	62.71	84.93	11.91	—	15BB	22494	63.50	82.55	11.10	—	12B.	17429	63.50	88.90	15.88	—	112B
17826	62.71	90.09	7.14	—	M3	22732	63.50	82.55	11.11	—	15BA	17429	63.50	88.90	15.88	—	112C
16771	63.00	75.00	5.00	—	15BB	12052	63.50	82.55	11.91	—	15C	13290	63.50	88.90	17.46	—	12BB
13697	63.00	75.20	5.00	—	14BA	—	63.50	82.55	12.70	—	12BA	15192	63.50	88.90	17.46	—	12B.
11200	63.00	76.20	9.00	—	15BA	15586	63.50	82.55	12.70	—	15B.	17041	63.50	88.90	17.80	—	11FB
22718	63.00	78.00	11.00	—	15BB	15586	63.50	82.55	12.70	—	15BB	17041	63.50	88.90	17.80	—	11FC
13198	63.00	80.00	8.00	—	15BA	15586	63.50	82.55	12.70	—	15B.	22747	63.50	88.90	17.86	—	15B.
13198	63.00	80.00	10.00	—	15B.	—	63.50	82.55	12.70	—	12BA	12674	63.50	88.90	17.86	—	12B.
25415	63.00	80.00	12.00	—	15BB	17336	63.50	82.55	15.88	—	I3	22748	63.50	88.90	19.05	—	15BA
12400	63.00	81.20	10.00	—	15BA	12035	63.50	83.34	11.11	—	15BA	18106	63.50	88.90	19.05	—	19B.



# Retentores

Perfis - Ver Última Página



INCOVE VEDAÇÕES LTDA.

Cod.	Di	De	Ha1	Ha2	Mod	Cod.	Di	De	Ha1	Ha2	Mod	Cod.	Di	De	Ha1	Ha2	Mod
20116	63.50	89.00	6.35	—	15BB	18645	63.50	101.60	12.70	—	15BA	20299	65.00	85.00	12.00	—	15BA
16468	63.50	89.00	12.70	—	17BB	22765	63.50	101.60	15.88	—	12B.	12841	65.00	85.00	12.00	—	15B.
19988	63.50	89.69	11.91	—	12BB	18308	63.50	101.60	15.88	—	12BC	16252	65.00	85.00	12.00	—	12BB
16707	63.50	90.00	12.00	—	12B.	22766	63.50	107.95	12.70	—	15B.	22782	65.00	85.00	12.00	—	12BA
16707	63.50	90.00	12.00	—	12BA	18646	63.50	108.00	12.70	—	15B.	20299	65.00	85.00	12.00	—	15BA
22750	63.50	90.09	9.53	—	15BA	16384	63.50	108.00	14.29	—	15BB	12807	65.00	85.00	13.00	—	12BA
22752	63.50	90.09	11.91	—	15B	22767	63.50	110.00	13.00	—	15B.	22785	65.00	85.00	13.00	—	15BB
15115	63.50	90.09	12.70	—	15B.	14680	63.50	110.30	12.70	—	15B.	22783	65.00	85.00	13.00	—	15BA
15115	63.50	90.09	12.70	—	15BB	14685	63.50	110.30	17.46	—	11FC	22784	65.00	85.00	13.00	—	15B.
15115	63.50	90.09	12.70	—	15BA	17409	63.50	114.30	22.23	—	11BF	22785	65.00	85.00	13.00	—	12BB
15115	63.50	90.09	12.70	—	15B.	15243	63.50	133.40	16.67	—	ESPE	12405	65.00	85.00	14.00	—	15BA
13283	63.50	90.09	12.70	—	12BB	17347	63.50	133.40	34.93	—	ESPE	16573	65.00	85.00	15.00	—	12BA
13283	63.50	90.09	12.70	—	12B.	15204	63.50	141.30	11.11	—	ESPE	22786	65.00	86.00	10.00	—	15B.
15115	63.50	90.09	12.70	—	15C	15247	63.50	141.30	16.67	—	ESPE	14512	65.00	88.00	12.00	—	15BB
15115	63.50	90.09	12.70	—	15C	15203	63.50	146.10	19.05	—	ESPE	14512	65.00	88.00	12.00	—	15BA
15166	63.50	90.09	15.88	—	14BB	15822	63.50	158.80	28.58	—	ESPE	22787	65.00	88.00	12.00	—	15B.
15166	63.50	90.09	15.88	—	15B.	12326	63.60	155.50	12.00	—	DISC	11505	65.00	88.00	12.00	—	12BB
15166	63.50	90.09	15.88	—	13C	.....	63.90	73.00	3.20	—	14BA	11505	65.00	88.00	12.00	—	12BA
13284	63.50	90.09	19.05	—	19C	17988	63.90	114.30	12.70	—	1815	12781	65.00	88.00	13.00	—	15B.
14833	63.50	90.09	22.23	—	17B.	14509	64.00	80.00	8.00	—	15BB	17780	65.00	88.60	12.70	—	15BA
15522	63.50	90.49	6.35	—	F	12259	64.00	80.00	8.00	—	12BA	13899	65.00	90.00	8.00	—	15BB
11595	63.50	90.49	9.53	—	15B.	12259	64.00	80.00	8.00	—	12BA	14513	65.00	90.00	10.00	—	15BB
13746	63.50	90.49	12.70	—	15B.	14509	64.00	80.00	8.00	—	15BA	14513	65.00	90.00	10.00	—	15BB
15243	63.50	90.49	17.07	—	ESPE	12259	64.00	80.00	8.00	—	12BA	11366	65.00	90.00	10.00	—	12BB
15160	63.50	92.08	7.94	—	F	22768	64.00	80.00	10.00	—	15B.	14513	65.00	90.00	10.00	—	15BB
13022	63.50	92.08	9.53	—	15BB	22769	64.00	84.50	11.00	—	15BB	14513	65.00	90.00	10.00	—	15BB
11471	63.50	92.08	9.53	—	12BA	22770	64.00	85.00	10.00	—	15B.	14513	65.00	90.00	10.00	—	15BB
12745	63.50	92.08	10.00	—	15BB	22771	64.00	85.00	13.00	—	15B.	22457	65.00	90.00	10.00	—	15JM
15442	63.50	92.08	11.91	—	15B.	16544	64.00	89.00	13.50	—	12BA	14513	65.00	90.00	10.00	—	15BA
20035	63.50	92.08	11.91	—	12B.	.....	64.00	90.00	10.00	—	12BB	14513	65.00	90.00	10.00	—	15B.
15442	63.50	92.08	11.91	—	15C	22772	64.00	90.00	10.00	—	15B.	11366	65.00	90.00	10.00	—	12BB
22754	63.50	92.08	12.70	—	15B.	22773	64.00	90.00	13.00	—	12BA	22788	65.00	90.00	10.00	—	12BA
22755	63.50	92.08	14.29	—	15B.	22774	64.00	94.00	15.00	—	15B.	14513	65.00	90.00	10.00	—	15B.
12404	63.50	92.08	14.29	—	12BA	16545	64.29	98.43	9.13	—	15BB	11366	65.00	90.00	10.00	—	12BB
13181	63.50	92.08	17.46	—	12B.	15463	64.29	155.60	13.49	—	ESPE	16979	65.00	90.00	11.00	—	14B.
14004	63.50	92.08	17.46	—	13B.	22775	65.00	74.00	12.00	—	15BB	11365	65.00	90.00	12.00	—	15BB
13182	63.50	92.08	17.46	—	11BF	14828	65.00	75.00	8.00	—	15BB	11365	65.00	90.00	12.00	—	15B.
16169	63.50	92.20	11.00	—	15BB	14828	65.00	75.00	8.00	—	15B.	18648	65.00	90.00	13.00	—	15BB
15468	63.50	93.66	12.70	—	F	22776	65.00	75.00	12.00	—	15BB	22790	65.00	90.00	13.00	—	15B.
22756	63.50	95.00	10.00	—	15BB	12666	65.00	75.00	12.00	—	15BA	22789	65.00	90.00	13.00	—	12BA
18264	63.50	95.25	7.94	—	ESPE	11631	65.00	77.00	6.00	—	15BB	13201	65.00	90.00	15.00	—	15BA
22757	63.50	95.25	7.94	—	15BB	16687	65.00	80.00	6.50	—	15BA	13201	65.00	90.00	15.00	—	15BA
20112	63.50	95.25	9.53	—	14BB	11742	65.00	80.00	7.00	—	14BA	13201	65.00	90.00	15.00	—	15BA
11312	63.50	95.25	9.53	—	15BA	14510	65.00	80.00	8.00	—	15BA	13809	65.00	90.00	15.00	—	12BA
11312	63.50	95.25	9.53	—	15B.	14510	65.00	80.00	8.00	—	15BB	13201	65.00	90.00	15.00	—	15BA
17924	63.50	95.25	12.70	—	180B	14510	65.00	80.00	8.00	—	15BA	22792	65.00	90.00	15.00	—	15BA
17216	63.50	95.25	12.70	—	15BB	13709	65.00	80.00	8.00	—	12BA	13809	65.00	90.00	15.00	—	12BA
22758	63.50	95.25	12.70	—	15BB	13709	65.00	80.00	8.00	—	12BB	13130	65.00	90.00	15.00	—	15BA
17216	63.50	95.25	12.70	—	15B.	14510	65.00	80.00	8.00	—	15BB	20044	65.00	92.00	14.00	—	15BB
16275	63.50	95.79	12.70	—	15B.	11223	65.00	80.00	9.00	—	15BB	22793	65.00	92.00	14.00	—	12BB
22759	63.50	98.43	6.35	—	15BA	13539	65.00	80.00	10.00	—	15BB	13181	65.00	92.00	17.80	—	12B.
22760	63.50	98.43	9.53	—	15BA	13539	65.00	80.00	10.00	—	15BA	13054	65.00	95.00	10.00	—	15BB
17410	63.50	98.43	9.53	—	15B.	13539	65.00	80.00	10.00	—	15B.	13054	65.00	95.00	10.00	—	15BB
18644	63.50	98.43	9.53	—	15B.	22778	65.00	80.00	12.00	—	15BB	13054	65.00	95.00	10.00	—	15B.
22761	63.50	98.43	11.91	—	15BB	16542	65.00	80.00	12.00	—	15B.	22794	65.00	95.00	10.00	—	12B.
17410	63.50	98.43	11.91	—	15BA	12822	65.00	85.00	9.00	—	14BB	16009	65.00	95.00	10.00	—	12JM
17410	63.50	98.43	11.91	—	15C	14511	65.00	85.00	10.00	—	15BB	22795	65.00	95.00	13.00	—	15B.
15533	63.50	98.43	12.70	—	F	16255	65.00	85.00	10.00	—	12BB	22796	65.00	95.00	13.00	—	12BA
15318	63.50	100.00	6.35	—	F	14511	65.00	85.00	10.00	—	15BB	13216	65.00	95.00	13.00	—	15B.
19123	63.50	100.00	9.53	—	12BB	14511	65.00	85.00	10.00	—	15BB	11854	65.00	95.00	14.00	—	15BA
14895	63.50	100.00	17.46	—	12BC	16555	65.00	85.00	10.00	—	12BB	11030	65.00	95.00	18.00	—	19B.
22762	63.50	100.01	9.53	—	12BA	16332	65.00	85.00	10.00	—	12BA	16848	65.00	98.07	12.00	—	12B.
22763	63.50	101.60	9.53	—	15BA	16555	65.00	85.00	10.00	—	12BB	22797	65.00	100.00	10.00	—	15BB
22764	63.50	101.60	11.91	—	15BA	22779	65.00	85.00	10.80	—	15B.	11767	65.00	100.00	10.00	—	12BB
18645	63.50	101.60	12.70	—	15BA	12841	65.00	85.00	12.00	—	15BB	22798	65.00	100.00	12.00	—	15B.
18645	63.50	101.60	12.70	—	15B.	12584	65.00	85.00	12.00	—	12BA	11675	65.00	100.00	12.00	—	12BB
18645	63.50	101.60	12.70	—	15C	12841	65.00	85.00	12.00	—	15BB	11675	65.00	100.00	12.00	—	12B.



# Retentores

Perfis - Ver Última Página



INCOVE VEDAÇÕES LTDA.

Cod.	Di	De	Ha1	Ha2	Mod	Cod.	Di	De	Ha1	Ha2	Mod	Cod.	Di	De	Ha1	Ha2	Mod
14737	65.00	100.00	13.00	—	I5BB	19086	65.09	101.60	11.11	—	I5B.	22822	66.68	88.90	12.70	—	I5BB
14737	65.00	100.00	13.00	—	I5BB	15525	65.09	109.50	7.94	—	F	15823	66.68	88.90	12.70	—	I5B.
14737	65.00	100.00	13.00	—	I5BA	18020	65.09	196.90	22.23	—	ESPE	11526	66.68	88.90	12.70	—	I2BB
14737	65.00	100.00	13.00	—	I5B.	15246	65.48	158.00	5.56	—	ESPE	22823	66.68	88.90	12.70	—	I2B.
16800	65.00	100.00	13.00	—	I2BA	13675	65.88	76.20	9.53	—	I5BA	15823	66.68	88.90	12.70	—	I5B.
11102	65.00	100.00	13.00	—	I1FB	15151	65.88	88.50	12.70	—	I5B.	15823	66.68	88.90	12.70	—	I5C
14514	65.00	110.00	12.00	—	I5B.	15151	65.88	88.50	12.70	—	I5BB	18245	66.68	88.90	17.86	—	I12
22799	65.00	110.00	12.00	—	I5B.	15151	65.88	88.50	12.70	—	I5B.	22824	66.68	90.09	11.91	—	I5BB
22800	65.00	115.00	15.00	—	I5B.	22811	65.88	88.50	12.70	—	I2B.	18920	66.68	90.09	12.70	—	I5BB
12406	65.00	120.00	13.00	—	I5BB	15151	65.88	88.50	12.70	—	I5C	15114	66.68	90.49	15.08	—	I13
16063	65.00	120.00	13.00	—	I2BB	22812	65.88	88.50	17.46	—	I2BA	13036	66.68	92.08	7.94	—	I5BB
12406	65.00	120.00	13.00	—	I5BB	15799	65.88	88.50	17.46	—	I1	22825	66.68	92.08	11.91	—	I2BA
13117	65.08	85.10	12.70	—	ESPE	22813	66.00	89.00	15.00	—	I5B.	15042	66.68	92.08	12.70	—	I5JM
12919	65.09	79.38	6.35	—	I4BA	22814	66.00	90.00	13.00	—	I5B.	15042	66.68	92.08	12.70	—	I5BB
22801	65.09	80.96	12.70	—	I5BB	22815	66.00	95.00	14.00	—	I5B.	13352	66.68	92.08	12.70	—	I2BA
19084	65.09	82.55	11.11	—	I5B.	16795	66.00	98.40	12.20	—	I5B.	15042	66.68	92.08	12.70	—	I5C
19085	65.09	84.93	11.11	—	I5BB	16608	66.00	98.50	11.00	—	I5B.	15042	66.68	92.08	12.70	—	I5B.
18327	65.09	85.73	12.70	—	I5B.	13138	66.00	101.00	37.00	—	ESPE	12407	66.68	92.08	15.88	—	I2BA
15963	65.09	87.31	6.35	—	F	20049	66.00	102.00	12.00	—	I5BB	22826	66.68	92.08	15.88	—	I2B.
17532	65.09	87.31	15.88	—	I13	22817	66.00	110.00	14.00	—	I5BB	12407	66.68	92.08	15.88	—	I2BA
17780	65.09	88.50	12.70	—	I5BA	13138	66.00	168.00	37.00	—	ESPE	17264	66.68	92.08	15.88	—	I3BC
13125	65.09	88.50	12.70	—	I2B.	15656	66.28	85.33	11.11	—	I5B.	17349	66.68	92.08	17.46	—	I2B.
17780	65.09	88.50	12.70	—	I5B.	15656	66.28	85.33	11.11	—	I5C	13395	66.68	92.08	17.46	—	I3BC
13125	65.09	88.50	12.70	—	I2B.	12078	66.28	94.85	15.48	—	I7B.	17149	66.68	92.08	19.05	—	I1BF
17780	65.09	88.50	12.70	—	I5C	16885	66.50	88.90	12.50	—	I5JL	25410	66.68	92.30	12.70	—	I5BB
15799	65.09	88.50	17.46	—	I1	15042	66.60	92.00	11.90	—	I5BB	17881	66.68	92.87	8.73	—	I/2
22803	65.09	88.90	9.53	—	I5BA	16661	66.60	98.40	11.95	—	I2B.	17694	66.68	93.66	9.53	—	F
13125	65.09	88.90	12.70	—	I5JM	25357	66.67	89.02	9.52	—	I2B.	22827	66.68	95.25	6.99	—	I2BB
22804	65.09	88.90	12.70	—	I5BB	15042	66.67	92.08	12.70	—	I5BA	17170	66.68	95.25	12.70	—	I5BB
22805	65.09	88.90	12.70	—	I5B.	22427	66.67	92.15	9.50	—	I2BA	17170	66.68	95.25	12.70	—	I5BB
17512	65.09	88.90	12.70	—	I2BB	22424	66.67	95.20	7.00	—	I5BB	17170	66.68	95.25	12.70	—	I5B.
17512	65.09	88.90	12.70	—	I2B.	25450	66.68	68.26	10.00	—	I5B	17170	66.68	95.25	12.70	—	I5C
18647	65.09	88.90	19.05	—	I1	19286	66.68	76.20	6.35	—	I4B.	14066	66.68	95.25	14.29	—	I2BC
18135	65.09	88.90	22.23	—	SANF	11067	66.68	77.20	7.00	—	I4BA	13482	66.68	95.25	15.88	—	I1FB
13456	65.09	90.09	12.70	—	I2BA	17694	66.68	77.79	9.53	—	F	17693	66.68	95.25	16.27	—	I2BA
13456	65.09	90.09	12.70	—	I2BB	15309	66.68	82.55	6.35	—	F	17693	66.68	95.25	16.27	—	I2BC
18648	65.09	90.09	12.70	—	I5B.	12577	66.68	82.55	12.70	—	I5BB	17693	66.68	95.25	16.27	—	I2BC
18648	65.09	90.09	12.70	—	I5BA	12665	66.68	84.93	9.53	—	I5BA	17466	66.68	95.25	19.05	—	I12B
13456	65.09	90.09	12.70	—	I2BA	15989	66.68	84.93	9.92	—	I13	14034	66.68	95.25	19.05	—	I1FB
18648	65.09	90.09	12.70	—	I5BB	15656	66.68	84.93	11.91	—	I5B.	22829	66.68	96.84	12.70	—	I5BA
13456	65.09	90.09	12.70	—	I2BA	15656	66.68	84.93	11.91	—	I5C	15511	66.68	98.43	11.91	—	I5B
13456	65.09	90.09	12.70	—	I2BB	22818	66.68	84.93	12.70	—	I5BA	22830	66.68	98.43	11.91	—	I5B.
18648	65.09	90.09	12.70	—	I5C	15898	66.68	85.33	11.11	—	I5B.	15511	66.68	98.43	11.91	—	I5B.
18648	65.09	90.09	12.70	—	I5BA	15376	66.68	85.73	7.94	—	F	18651	66.68	98.43	15.88	—	I3
13456	65.09	90.09	12.70	—	I2BB	22819	66.68	85.73	7.94	—	I5BB	13343	66.68	100.00	11.11	—	I2B.
22806	65.09	90.49	11.91	—	I5BB	20088	66.68	85.73	9.13	—	I2BB	15795	66.68	100.00	12.70	—	I5BB
15674	65.09	90.49	11.91	—	ESPE	15928	66.68	85.73	9.53	—	I5BB	15795	66.68	100.00	12.70	—	I5B.
15114	65.09	90.49	15.08	—	I13	15928	66.68	85.73	9.53	—	I5B.	15795	66.68	100.00	12.70	—	I5C
22807	65.09	92.08	17.86	—	I2B.	18278	66.68	85.73	11.91	—	I13	14840	66.68	100.00	17.86	—	I2BC
15932	65.09	92.09	7.94	—	F	17201	66.68	85.73	11.91	—	I5BB	22831	66.68	100.01	12.70	—	I5B.
16882	65.09	92.09	11.11	—	I2B.	17201	66.68	85.73	11.91	—	I5BA	15076	66.68	101.60	12.70	—	I5B.
15407	65.09	92.09	11.91	—	I5BB	17201	66.68	85.73	11.91	—	I5B.	22832	66.68	101.60	12.70	—	I2BB
15407	65.09	92.09	11.91	—	I5B.	22820	66.68	85.73	12.70	—	I5B.	14785	66.68	101.60	17.46	—	ESPE
13315	65.09	92.09	11.91	—	I2BA	18040	66.68	85.73	14.29	—	I/2	15855	66.68	104.00	14.29	—	ESPE
15407	65.09	92.09	11.91	—	I5C	17993	66.68	85.73	17.46	—	I121	17605	66.68	108.00	29.37	—	I55
11289	65.09	92.09	12.70	—	I5B.	17421	66.68	85.73	19.05	—	I1FC	17212	66.68	109.50	20.64	—	I1BF
11289	65.09	92.09	12.70	—	I5BB	15928	66.68	85.93	—	—	I5BB	17382	66.68	112.70	7.94	—	I815
22808	65.09	94.46	9.53	—	I5BA	17639	66.68	87.31	9.53	—	F	15526	66.68	112.70	11.11	—	I5B.
22809	65.09	95.25	9.53	—	I5B.	17778	66.68	87.31	12.70	—	I5C	14886	66.68	112.70	11.11	—	ESPE
22810	65.09	95.25	12.70	—	I5BB	13002	66.68	88.11	11.91	—	I5BA	18093	66.68	112.70	20.64	—	ESPE
17282	65.09	95.25	12.70	—	I5B.	18927	66.68	88.50	6.35	—	I4	22833	66.68	112.71	11.11	—	I5B.
17282	65.09	95.25	12.70	—	I5B.	15799	66.68	88.50	17.46	—	I1	15435	66.68	114.30	4.76	—	DISC
18649	65.09	95.25	12.70	—	I5C	17640	66.68	88.90	7.94	—	F	17139	66.68	114.30	10.32	—	I13
17509	65.09	98.43	11.91	—	I5C	15254	66.68	88.90	9.53	—	I5BB	17841	66.68	115.90	6.35	—	I815
18650	65.09	98.43	15.08	—	I3	22821	66.68	88.90	11.11	—	I5B.	14727	66.68	115.90	22.23	—	I1FC
19966	65.09	98.43	19.05	—	I1FC	15162	66.68	88.90	11.11	—	F	.....	66.70	85.60	12.00	—	I2B.
15600	65.09	100.00	12.70	—	F	15823	66.68	88.90	12.70	—	I5BB	22570	66.70	88.55	12.70	—	I5B.



# Retentores

Perfis - Ver Última Página



INCOVE VEDAÇÕES LTDA.

Cod.	Di	De	Ha1	Ha2	Mod	Cod.	Di	De	Ha1	Ha2	Mod	Cod.	Di	De	Ha1	Ha2	Mod
.....	66.70	92.00	11.00	—	I2B.	20359	68.00	125.00	13.80	—	I2B.	22866	69.85	90.09	9.53	—	I5BB
15042	66.70	92.00	12.00	—	I5B.	16092	68.20	88.90	9.50	—	I2BA	13291	69.85	90.09	12.70	—	I2BB
11852	66.80	95.00	12.70	—	I5BB	11166	68.26	79.38	12.70	—	I5B.	13291	69.85	90.09	12.70	—	I2BB
22456	67.00	76.20	12.00	—	I5BB	15532	68.26	80.96	12.70	—	F	13291	69.85	90.09	12.70	—	I2BA
11272	67.00	80.00	10.00	—	I5BA	17042	68.26	82.55	7.94	—	I5BB	15200	69.85	90.09	12.70	—	I5BB
12491	67.00	85.00	10.00	—	I5B.	15016	68.26	82.55	14.29	—	ESPE	15200	69.85	90.09	12.70	—	I5BB
22834	67.00	85.00	10.00	—	I2BA	22854	68.26	85.73	9.53	—	I2BB	15200	69.85	90.09	12.70	—	I5B.
12693	67.00	85.00	10.00	—	I7B.	19087	68.26	85.73	11.11	—	I5BB	13291	69.85	90.09	12.70	—	I2BA
22836	67.00	86.00	9.50	—	I5BA	17756	68.26	87.31	12.70	—	I5B.	22867	69.85	90.09	12.70	—	I2BA
16189	67.00	87.00	10.00	—	I5BB	15110	68.26	88.90	7.94	—	F	13291	69.85	90.09	12.70	—	I2B.
25258	67.00	87.00	13.00	—	I5BB	18652	68.26	88.90	12.70	—	I5BB	15200	69.85	90.09	12.70	—	I5BA
22837	67.00	90.00	13.00	—	I5B.	18652	68.26	88.90	12.70	—	I5C	15200	69.85	90.09	12.70	—	I5BB
22838	67.00	95.00	7.00	—	I2BB	22855	68.26	90.09	11.11	—	I5BB	15200	69.85	90.09	12.70	—	I5C
15559	67.47	90.49	13.49	—	I13	15778	68.26	90.09	12.70	—	I13	17820	69.85	90.09	15.88	—	I3BC
18624	67.50	90.20	9.53	—	I5BB	19088	68.26	90.09	12.70	—	I5B.	16230	69.85	90.49	9.53	—	I5BB
20006	68.00	78.00	6.00	—	I5BB	15559	68.26	90.49	12.70	—	I13	18658	69.85	92.08	6.35	—	I4
11325	68.00	84.00	7.00	—	I5BB	22856	68.26	92.08	11.11	—	I5B.	15807	69.85	92.08	9.53	—	I5BA
11325	68.00	84.00	7.00	—	I5BB	19089	68.26	92.09	11.11	—	I5B.	15807	69.85	92.08	9.53	—	I5B.
25438	68.00	85.00	8.00	—	I5BA	13103	68.26	92.09	15.88	—	I13	15499	69.85	92.08	11.91	—	I5BB
25325	68.00	85.00	8.00	—	I5BB	15639	68.26	95.25	9.53	—	1/2	15499	69.85	92.08	11.91	—	I5B.
.....	68.00	85.00	10.00	—	I2BB	17727	68.26	95.25	12.70	—	I80B	18657	69.85	92.08	14.29	—	I2BB
13933	68.00	85.00	10.00	—	I5BB	17017	68.26	95.25	12.70	—	I5JM	18657	69.85	92.08	14.29	—	I2BB
13933	68.00	85.00	10.00	—	I5BA	17017	68.26	95.25	12.70	—	I5B.	18657	69.85	92.08	14.29	—	I2B.
.....	68.00	85.00	10.00	—	I5BA	15211	68.26	95.25	12.70	—	I4C	18657	69.85	92.08	14.29	—	I2BA
13934	68.00	85.00	11.00	—	I5BB	17017	68.26	95.25	12.70	—	I5B.	22869	69.85	92.08	15.08	—	I2BB
11663	68.00	85.00	13.00	—	I5BB	17017	68.26	95.25	12.70	—	I5C	22868	69.85	92.08	15.08	—	I2B.
22841	68.00	85.00	13.00	—	I5BA	18653	68.26	95.55	15.88	—	I3	15173	69.85	92.08	18.26	—	LATA
22842	68.00	85.00	13.00	—	I5B.	18654	68.26	96.84	12.70	—	I13	18157	69.85	93.66	12.70	—	F
14515	68.00	85.00	13.00	—	I2BA	22857	68.26	98.26	12.70	—	I5B.	17245	69.85	95.25	6.35	—	I4B.
14515	68.00	85.00	13.00	—	I2B.	18655	68.26	98.43	6.35	—	I4	16072	69.85	95.25	9.52	—	I5B.
16897	68.00	89.60	12.00	—	I13B	15004	68.26	98.43	11.91	—	I5C	16072	69.85	95.25	9.52	—	I2BA
13244	68.00	90.00	10.00	—	I2BA	15004	68.26	98.43	11.91	—	I5B.	16072	69.85	95.25	9.52	—	I5BA
14516	68.00	90.00	10.00	—	I5BA	18911	68.26	98.43	12.70	—	I80B	22870	69.85	95.25	9.53	—	I5B.
13244	68.00	90.00	10.00	—	I2BA	18911	68.26	98.43	12.70	—	I80C	22871	69.85	95.25	9.53	—	I2BA
.....	68.00	90.00	10.00	—	I5BB	18656	68.26	101.60	11.91	—	I5B.	13323	69.85	95.25	10.00	—	I2B.
22844	68.00	90.00	10.00	—	I5BB	13847	68.50	84.50	8.00	11.00	RASP	13323	69.85	95.25	11.11	—	I2BA
14516	68.00	90.00	10.00	—	I5BA	16288	69.00	83.00	10.50	—	I5B.	17291	69.85	95.25	11.11	—	F
13244	68.00	90.00	10.00	—	I2BB	16479	69.00	86.00	10.00	—	I5BB	22872	69.85	95.25	11.11	—	I5B.
22846	68.00	90.00	10.00	—	I2BB	22858	69.00	90.00	10.00	—	I5BB	13323	69.85	95.25	11.11	—	I2BA
13244	68.00	90.00	10.00	—	I2B.	22859	69.00	90.00	13.00	—	I5B.	17291	69.85	95.25	11.11	—	ESPE
.....	68.00	90.00	10.00	—	I5BA	22512	69.00	95.00	10.00	—	I5B.	13322	69.85	95.25	11.13	—	I2BB
14516	68.00	90.00	10.00	—	I5BB	22860	69.06	88.90	9.53	—	I5BA	15510	69.85	95.25	12.70	—	I5C
14516	68.00	90.00	10.00	—	I5B.	.....	69.80	90.00	8.00	—	I5BB	15510	69.85	95.25	12.70	—	I5B.
16102	68.00	90.00	12.00	—	I5B.	.....	69.80	90.00	10.00	—	I2BA	15510	69.85	95.25	12.70	—	I5BB
13245	68.00	90.00	13.00	—	I2BA	.....	69.80	92.00	11.00	—	I2BB	22873	69.85	95.25	12.70	—	I5B.
13245	68.00	90.00	13.00	—	I2BA	.....	69.80	98.45	11.80	18.30	I2BA	22874	69.85	95.25	12.70	—	I2BB
14517	68.00	90.00	13.00	—	I5BB	18041	69.85	85.73	11.11	—	1/2	13322	69.85	95.25	12.70	—	I2B.
22847	68.00	90.00	13.00	—	I5BA	18044	69.85	85.73	11.91	—	1/2	15510	69.85	95.25	12.70	—	I5JM
14517	68.00	90.00	13.00	—	I5B.	17095	69.85	86.52	11.91	—	1/2	15510	69.85	95.25	12.70	—	I5C
14517	68.00	90.00	13.00	—	I2BA	22861	69.85	86.69	12.70	—	I5BB	15510	69.85	95.25	12.70	—	I5BA
13245	68.00	90.00	13.00	—	I2BA	17302	69.85	88.50	12.70	—	I5BB	13322	69.85	95.25	12.70	—	I2BA
13504	68.00	90.00	13.00	—	I5BA	17302	69.85	88.50	12.70	—	I5BA	13322	69.85	95.25	12.70	—	I2B.
22848	68.00	90.00	14.00	—	I5BA	17302	69.85	88.50	12.70	—	I5C	12212	69.85	95.25	15.88	—	I2B.
12408	68.00	90.00	14.00	—	I2BA	18341	69.85	88.90	6.35	—	I4B	12212	69.85	95.25	15.88	—	I2B.
22849	68.00	95.00	10.00	—	I5BB	22862	69.85	88.90	6.35	—	I5BB	17034	69.85	95.25	16.67	—	I3BC
22850	68.00	95.00	12.00	—	I2BB	17662	69.85	88.90	9.53	—	I5BA	15516	69.85	95.25	17.86	—	I12B
16190	68.00	95.00	13.00	—	I2BB	22863	69.85	88.90	9.53	—	I5B.	12409	69.85	95.25	18.26	—	I3BC
22851	68.00	95.00	13.00	—	I5BB	22519	69.85	88.90	9.53	—	I5BB	15546	69.85	95.25	19.05	—	I1FB
16190	68.00	95.00	13.00	—	I2BB	22864	69.85	88.90	10.90	—	I5BA	15546	69.85	95.25	19.05	—	I1FC
11747	68.00	95.00	16.00	—	I1FA	12098	69.85	88.90	11.91	—	I5JL	22508	69.85	95.40	11.11	—	I5B.
22852	68.00	98.00	10.00	—	I5B.	15374	69.85	88.90	12.70	—	F	22875	69.85	95.65	11.91	—	I5B.
11917	68.00	100.00	10.00	—	I5BB	17050	69.85	88.90	12.70	—	I5BA	17301	69.85	95.65	11.91	—	I5B.
16310	68.00	100.00	12.00	—	I5BB	17050	69.85	88.90	12.70	—	I5BB	17301	69.85	95.65	11.91	—	I5C
22853	68.00	100.00	12.00	—	I5B.	17050	69.85	88.90	12.70	—	I5BA	17278	69.85	95.65	17.46	—	I3
16107	68.00	102.00	9.50	—	I2BA	22865	69.85	88.90	12.70	—	I5B.	18266	69.85	96.04	14.29	—	L DI
20358	68.00	118.00	15.00	—	I2B.	17050	69.85	88.90	12.70	—	I5C	15986	69.85	98.43	6.35	—	F
20357	68.00	120.00	9.00	—	I2B.	15767	69.85	89.69	6.35	—	I13	15386	69.85	98.43	11.91	—	I5B





# Retenfores

Perfis - Ver Última Página



INCOVE VEDAÇÕES LTDA.

Cod.	Di	De	Ha1	Ha2	Mod	Cod.	Di	De	Ha1	Ha2	Mod	Cod.	Di	De	Ha1	Ha2	Mod
15386	69.85	98.43	11.91	—	I5B	14518	70.00	85.00	8.00	—	I5BA	22904	70.00	100.00	6.00	—	I5BB
15386	69.85	98.43	11.91	—	I5B	14518	70.00	85.00	8.00	—	I5BA	14520	70.00	100.00	10.00	—	I5B.
12228	69.85	98.43	11.91	—	I2BA	.....	70.00	85.00	8.00	—	I2BA	14520	70.00	100.00	10.00	—	I5BB
22876	69.85	98.43	11.91	—	I5B.	14518	70.00	85.00	8.00	—	I5B.	22905	70.00	100.00	10.00	—	I5BA
12228	69.85	98.43	11.91	—	I2BA	12844	70.00	85.00	8.00	—	I2BB	16326	70.00	100.00	10.00	—	I2BB
15386	69.85	98.43	11.91	—	I5B.	14518	70.00	85.00	8.00	—	I5BB	14520	70.00	100.00	10.00	—	I5BB
12410	69.85	98.43	12.70	—	I5B	12844	70.00	85.00	8.00	—	I2BA	14520	70.00	100.00	10.00	—	I5BB
12410	69.85	98.43	12.70	—	I5B	14518	70.00	85.00	8.00	—	I5BB	16910	70.00	100.00	10.30	—	I4BA
12410	69.85	98.43	12.70	—	I5B.	14518	70.00	85.00	8.00	—	I5BA	14521	70.00	100.00	12.00	—	I5BB
22877	69.85	98.43	12.70	—	I5BB	22890	70.00	85.00	10.00	—	I2BA	11746	70.00	100.00	12.00	—	I5BB
13357	69.85	98.43	15.08	—	I2BB	13850	70.00	85.00	12.00	—	I5BB	14521	70.00	100.00	12.00	—	I5B.
17093	69.85	98.43	15.88	—	I3B.	11098	70.00	86.00	8.00	—	I5B.	11746	70.00	100.00	12.00	—	I2BB
22879	69.85	98.43	15.88	—	I2B.	20202	70.00	88.00	10.00	—	I5JM	14521	70.00	100.00	12.00	—	I5BB
17093	69.85	98.43	15.88	—	I3C	16207	70.00	88.00	10.00	—	I2BA	11746	70.00	100.00	12.00	—	I2BB
12411	69.85	98.43	17.86	—	I3BC	16418	70.00	89.00	6.00	—	I5BB	22907	70.00	100.00	13.00	—	I5BB
19951	69.85	98.43	19.05	—	I21B	16222	70.00	89.00	6.60	—	I2BB	13505	70.00	100.00	13.00	—	I5B.
18288	69.85	98.43	19.05	—	I1FC	11682	70.00	90.00	7.00	—	I2BB	22906	70.00	100.00	13.00	—	I5B.
18659	69.85	100.00	12.70	—	I5B.	11441	70.00	90.00	8.00	—	I5BB	13505	70.00	100.00	13.00	—	I5BB
15388	69.85	100.00	12.70	—	I813	13600	70.00	90.00	10.00	—	I2BA	20042	70.00	100.00	14.00	—	I2BB
19387	69.85	100.00	30.16	—	SANF	13600	70.00	90.00	10.00	—	I2BB	20042	70.00	100.00	14.00	—	I2BB
22880	69.85	101.01	12.70	—	I5B.	13600	70.00	90.00	10.00	—	I2BA	16993	70.00	102.00	12.50	—	I5BB
22882	69.85	101.60	11.11	—	I5B.	14519	70.00	90.00	10.00	—	I5BB	14524	70.00	105.00	13.00	—	I5BB
22881	69.85	101.60	11.11	—	I2B.	14519	70.00	90.00	10.00	—	I5BB	14524	70.00	105.00	13.00	—	I5BA
17222	69.85	101.60	11.91	—	I5BB	13600	70.00	90.00	10.00	—	I2BB	22909	70.00	105.00	13.00	—	I5B.
17222	69.85	101.60	11.91	—	I5B.	13600	70.00	90.00	10.00	—	I2BB	14524	70.00	105.00	13.00	—	I5BA
12043	69.85	101.60	12.70	—	I5B.	17751	70.00	90.00	10.00	—	I4BA	12061	70.00	110.00	6.50	—	I5BB
16338	69.85	101.60	12.70	—	I2B.	14519	70.00	90.00	10.00	—	I5BB	14525	70.00	110.00	8.00	—	I5BB
16141	69.85	101.60	15.88	—	I2B.	14519	70.00	90.00	10.00	—	I5BA	14525	70.00	110.00	8.00	—	I5BA
17193	69.85	101.60	15.88	—	I3	14519	70.00	90.00	10.00	—	I5BA	14525	70.00	110.00	8.00	—	I5BA
18215	69.85	101.60	20.64	—	I813	14519	70.00	90.00	10.00	—	I5B.	16889	70.00	110.00	10.00	—	I2BB
15764	69.85	103.20	12.70	—	I5B.	13600	70.00	90.00	10.00	—	I2BB	16974	70.00	110.00	12.00	—	I5BB
22883	69.85	104.17	15.88	—	I5B.	17751	70.00	90.00	10.00	—	ESPE	22910	70.00	110.00	13.00	—	I5BB
22884	69.85	107.95	6.35	—	I5BA	14519	70.00	90.00	10.00	—	I5BB	22911	70.00	110.00	13.00	—	I5BA
22885	69.85	107.95	12.70	—	I2BA	11638	70.00	90.00	12.00	—	I2BA	13506	70.00	110.00	13.00	—	I5B.
22886	69.85	107.95	15.88	—	I2B.	11145	70.00	90.00	12.00	—	I5JL	11662	70.00	110.00	16.00	—	I2BB
19071	69.85	108.00	6.35	—	I5BB	22892	70.00	90.00	12.00	—	I5B	16188	70.00	115.00	14.00	—	I5BB
19071	69.85	108.00	6.35	—	I5BA	22893	70.00	90.00	12.00	—	I5BB	16188	70.00	115.00	14.00	—	I5BB
19071	69.85	108.00	6.35	—	I5BA	11638	70.00	90.00	12.00	—	I2B.	14526	70.00	115.00	15.00	—	I5BA
14677	69.85	108.00	12.70	—	I5C	13914	70.00	90.00	13.00	—	I5B	13844	70.00	120.00	10.00	—	I5BA
13379	69.85	108.00	12.70	—	I5C	15200	70.00	90.00	13.00	—	I5BB	22912	70.00	120.00	10.00	—	I2BB
17231	69.85	108.00	15.88	—	I5B.	22896	70.00	90.00	13.00	—	I5BA	22914	70.00	120.00	12.90	—	I5B.
15242	69.85	108.00	19.05	—	I3BC	13914	70.00	90.00	13.00	—	I5B.	11385	70.00	120.00	13.00	—	I5BA
14525	69.85	109.50	9.53	—	I5BA	22895	70.00	90.00	13.00	—	I2BB	12859	70.00	150.00	10.00	—	I5BB
19906	69.85	110.30	14.29	—	I9B.	16653	70.00	90.00	13.00	—	I7BB	22915	70.64	79.38	13.10	—	I5B.
19103	69.85	110.30	15.88	—	I2BA	22898	70.00	90.00	15.00	—	I5BB	22916	71.00	85.00	8.00	—	I5BB
22887	69.85	110.33	15.88	—	I2B.	22897	70.00	90.00	15.00	—	I2BA	12916	71.00	92.15	9.50	—	I5BB
15358	69.85	113.50	11.11	—	I5B.	22546	70.00	90.00	15.00	—	I2BB	22917	71.00	100.00	13.00	—	I5B.
18218	69.85	114.30	12.70	—	I5B.	16354	70.00	90.00	15.00	—	I2BB	22918	71.44	88.50	12.70	—	I5BA
16164	69.85	120.01	14.22	—	I2BA	12291	70.00	90.50	10.00	—	I5BB	19090	71.44	88.90	11.11	—	I5BA
18661	69.85	127.00	11.91	—	I5B.	22899	70.00	92.00	7.00	—	I5BB	22919	71.44	88.90	11.11	—	I5B.
18660	69.85	127.00	15.08	—	I3	13671	70.00	92.00	12.00	—	I5BB	19091	71.44	90.09	11.11	—	I5B.
17107	69.85	157.20	17.46	—	ESPE	13671	70.00	92.00	12.00	—	I5BA	15489	71.44	90.49	7.94	—	F
22888	69.85	169.86	13.10	—	I5B.	16186	70.00	92.00	12.00	—	I2BB	19092	71.44	92.08	11.11	—	I5B.
17867	69.85	169.90	13.10	—	ESPE	22900	70.00	92.00	12.00	—	I2BA	15743	71.44	93.66	11.11	—	F
14193	69.85	—	0.01	—	ESPE	13867	70.00	94.00	16.00	—	I2B.	12910	71.44	95.25	6.35	—	I2BB
22486	69.90	92.10	9.50	—	I2B.	12922	70.00	94.50	10.00	—	I4JM	17445	71.44	95.25	12.70	—	I5BB
—	69.90	92.25	12.70	—	I2B.	13716	70.00	95.00	10.00	—	I5BB	17445	71.44	95.25	12.70	—	I5BA
11579	70.00	12.00	10.00	—	I2BB	22902	70.00	95.00	10.00	—	I2BB	17445	71.44	95.25	12.70	—	I5BA
22889	70.00	80.00	10.00	—	I2BB	22903	70.00	95.00	11.00	—	I5B.	22920	71.44	95.25	13.10	—	I5B.
11822	70.00	80.00	12.00	—	I5BB	12455	70.00	95.00	12.00	—	I5BB	15793	71.44	96.84	11.11	—	JM
11668	70.00	82.80	8.00	—	I5BA	12455	70.00	95.00	12.00	—	I5B.	18999	71.44	98.43	4.76	—	I4
—	70.00	85.00	7.00	—	I4BB	12227	70.00	95.00	13.00	—	I2BB	15443	71.44	98.43	11.91	—	I5BB
11132	70.00	85.00	7.00	—	I5BB	12455	70.00	95.00	13.00	—	I5BB	22921	71.44	98.43	11.91	—	I5B.
12844	70.00	85.00	8.00	—	I2BA	12455	70.00	95.00	13.00	—	I5BA	15443	71.44	98.43	11.91	—	I5B.
14518	70.00	85.00	8.00	—	I5BB	11548	70.00	95.00	13.00	—	I5B.	15443	71.44	98.43	11.91	—	I5B
—	70.00	85.00	8.00	—	I2BB	12227	70.00	95.00	13.00	—	I2BB	12539	71.44	98.43	15.08	—	I3BC
14518	70.00	85.00	8.00	—	I5BB	13860	70.00	98.00	12.00	—	I5BB	15562	71.44	98.43	15.88	—	I2B.



# Retentores

Perfis - Ver Última Página



INCOVE VEDAÇÕES LTDA.

Cod.	Di	De	Ha1	Ha2	Mod	Cod.	Di	De	Ha1	Ha2	Mod	Cod.	Di	De	Ha1	Ha2	Mod
19950	71.44	98.43	17.46	—	I121	22947	73.00	95.00	10.00	—	I5BA	13193	73.03	101.60	14.29	—	I2BA
17309	71.44	101.60	11.91	—	I5C	22947	73.00	95.00	10.00	—	I5B.	13413	73.03	101.60	14.29	—	I1BF
17695	71.44	101.60	16.67	—	I2B.	16097	73.00	96.00	8.70	—	I5BB	13193	73.03	101.60	14.70	—	I1FA
22922	71.44	104.78	11.91	—	I5B.	22948	73.00	100.00	13.00	—	I5B.	17659	73.03	101.60	15.88	—	I2BA
19075	71.44	104.80	11.91	—	I5BA	13193	73.00	101.60	11.50	—	I2BA	17659	73.03	101.60	15.88	—	I2B.
22923	71.44	107.95	6.35	—	I5BA	22949	73.00	104.00	11.00	—	I5BA	13413	73.03	101.60	15.88	—	I3BC
17908	71.44	111.10	9.53	—	F	16621	73.00	105.00	8.00	—	I5BB	14552	73.03	101.60	17.46	—	ESPE
17166	71.44	114.30	10.32	—	I13	14531	73.00	110.00	13.00	—	I5B.	14552	73.03	101.60	17.46	—	I12B
18662	71.44	114.30	11.91	—	I5B.	14531	73.00	110.00	13.00	—	I5C	12301	73.03	101.60	18.65	—	ESPE
22924	71.44	114.30	14.29	—	I2BB	16306	73.00	110.00	13.50	—	I5BB	14671	73.03	101.60	22.23	—	I7B.
14667	72.00	80.00	12.00	—	I4BA	14532	73.00	125.00	13.00	—	I5BA	11749	73.03	101.80	6.35	—	I5JM
22925	72.00	84.00	7.00	—	I5BA	20059	73.00	125.20	12.70	—	I5BB	14746	73.03	104.00	25.40	—	ESPE
11226	72.00	84.00	7.00	—	I5B.	18088	73.03	90.49	9.53	—	F	22969	73.03	104.78	14.29	—	I5B.
22926	72.00	85.00	8.00	—	I5BA	22950	73.03	92.08	7.94	—	I2BA	15157	73.03	104.80	7.94	—	F
14527	72.00	85.00	8.00	—	I5B.	15687	73.03	92.08	7.94	—	I2BA	17358	73.03	104.80	14.29	—	I5B.
12092	72.00	85.60	18.00	—	I5BA	11547	73.03	92.08	9.53	—	I5BB	17827	73.03	104.80	20.60	—	ESPE
22577	72.00	90.00	10.00	—	I5BB	22952	73.03	92.08	9.53	—	I2BB	17827	73.03	104.80	20.64	—	ESPE
25368	72.00	90.00	10.00	—	I2BB	15976	73.03	92.08	12.70	—	I5B.	17633	73.03	104.80	22.23	—	I1
22927	72.00	90.00	10.00	—	I5BA	14798	73.03	93.66	19.05	—	ESPE	22970	73.03	107.95	15.08	—	I5B.
22577	72.00	90.00	10.00	—	I5BB	13645	73.03	95.25	9.53	—	I2BA	18102	73.03	109.50	12.70	—	I5C
22928	72.00	90.00	12.00	—	I5BA	16590	73.03	95.25	11.11	—	I5B.	22971	73.03	109.54	12.70	—	I5B.
14487	72.00	90.00	13.00	—	I5B.	22953	73.03	95.25	11.91	—	I5BA	18129	73.03	110.30	11.11	—	I13
16613	72.00	92.00	10.00	—	I5BB	15206	73.03	95.25	12.70	—	I5B.	17488	73.03	110.30	11.11	—	I5B.
12692	72.00	95.00	10.00	—	I5BB	15206	73.03	95.25	12.70	—	I5BA	13404	73.03	110.30	12.70	—	I5B.
12692	72.00	95.00	10.00	—	I5BA	15206	73.03	95.25	12.70	—	I5BB	17491	73.03	110.30	26.19	—	I7B.
22930	72.00	95.00	10.00	—	I5B.	22954	73.03	95.25	12.70	—	I5BA	19291	73.03	110.30	26.99	—	I9C
22929	72.00	95.00	10.00	—	I2BB	15206	73.03	95.25	12.70	—	I5B.	15387	73.03	111.10	9.53	—	F
22932	72.00	95.00	12.00	—	I5BB	22955	73.03	95.25	12.70	—	I2BA	17014	73.03	111.10	15.88	—	I1FB
22931	72.00	95.00	12.00	—	I5B.	15206	73.03	95.25	12.70	—	I5C	22972	73.03	111.13	15.88	—	I5B.
17445	72.00	95.00	13.00	—	I5BB	22956	73.03	95.25	15.88	—	I2B.	18989	73.03	111.90	7.14	—	I4C
22934	72.00	95.00	13.00	—	I5BA	22957	73.03	95.25	17.46	—	I2B.	22973	73.03	114.10	11.11	—	I5B.
22935	72.00	95.00	13.00	—	I5B.	15183	73.03	95.25	17.46	—	I9C	17166	73.03	114.30	10.32	—	I13
16692	72.00	95.00	13.00	—	I2BA	15993	73.03	95.25	19.05	—	F	17692	73.03	114.30	11.91	—	I5C
13578	72.00	95.00	16.00	—	I5BA	17357	73.03	95.25	19.05	—	I5B.	17692	73.03	114.30	12.70	—	I5B.
22936	72.00	98.00	11.00	—	I5BB	17357	73.03	95.25	19.05	—	I1BF	22974	73.03	119.06	11.91	—	I5BB
14063	72.00	100.00	10.00	—	I5BB	17427	73.03	95.25	25.40	—	I9C	22975	73.03	125.02	12.70	—	I5BA
22937	72.00	100.00	10.00	—	I5BA	17427	73.03	95.25	25.40	—	I9C	22976	73.03	127.00	11.91	—	I5BA
14063	72.00	100.00	10.00	—	I5B.	14798	73.03	95.25	26.99	—	ESPE	15296	73.03	127.00	11.91	—	I5BA
14063	72.00	100.00	10.00	—	I5B.	15593	73.03	96.84	12.70	—	F	13304	73.03	127.00	19.05	—	I5BB
11646	72.00	100.00	12.00	—	I5B.	17485	73.03	98.43	4.76	—	I4BA	13304	73.03	127.00	19.05	—	I5BB
22939	72.00	100.00	13.00	—	I5B.	17485	73.03	98.43	4.76	—	I4B.	15430	73.03	133.40	6.35	—	ESPE
22938	72.00	100.00	13.00	—	I2BB	17485	73.03	98.43	4.76	—	I4BA	22977	73.03	136.53	12.70	—	I2B.
22940	72.00	105.00	11.00	—	I5BB	17485	73.03	98.43	4.76	—	I4C	15290	73.03	146.80	26.19	—	ESPE
14529	72.00	105.00	13.00	—	I5BB	12167	73.03	98.43	6.35	—	I4B.	15464	73.03	166.70	13.50	—	ESPE
14529	72.00	105.00	13.00	—	I5B.	22958	73.03	98.43	9.53	—	I5B.	18156	73.03	184.20	50.80	—	ESPE
14529	72.00	105.00	13.00	—	I5B.	22959	73.03	98.43	11.11	—	I5BB	14746	73.03	196.90	25.40	—	ESPE
11149	72.00	110.00	13.00	—	I5B.	17109	73.03	98.43	11.91	—	I5BB	20191	73.20	101.80	6.70	—	I4BB
14530	72.00	120.00	13.00	—	I5B.	17109	73.03	98.43	11.91	—	I5B.	20191	73.20	101.80	6.70	—	I4BB
—	72.00	127.00	12.00	—	I2BB	22960	73.03	98.43	11.91	—	I2BB	11965	73.50	90.09	12.70	—	I5BA
22941	72.00	127.00	19.00	—	I5BB	17109	73.03	98.43	11.91	—	I5C	11855	73.50	92.00	7.00	—	I5BB
25356	72.00	140.00	12.00	—	I5BB	17345	73.03	98.43	12.70	—	I80B	15548	73.82	96.84	7.94	—	F
22942	72.23	92.08	9.53	—	I5BA	22961	73.03	98.43	12.70	—	I5B.	15964	73.82	103.20	11.11	—	F
22943	72.23	95.25	12.70	—	I2BB	12701	73.03	98.43	12.70	—	I2B.	14533	74.00	90.00	10.00	—	I5BA
15262	72.23	100.00	12.70	—	I5B.	17110	73.03	98.43	15.88	—	I3	12414	74.00	90.00	10.00	12.00	I2BB
15262	72.23	100.00	12.70	—	I5BB	19960	73.03	99.22	3.18	—	I4BA	12414	74.00	90.00	10.00	12.00	I2BA
15262	72.23	100.00	12.70	—	I5C	17138	73.03	100.00	18.26	—	I5BB	14499	74.00	90.00	12.00	—	I2BA
22944	72.23	100.01	12.70	—	I5B.	22962	73.03	100.01	18.26	—	I5BB	22979	74.00	90.00	12.00	—	I5BA
22945	72.23	101.60	15.88	—	I2B.	18340	73.03	101.60	6.35	—	I4	14499	74.00	90.00	12.00	—	I2BB
18142	72.23	108.00	26.99	—	SANF	22965	73.03	101.60	11.11	—	I5BB	14499	74.00	90.00	12.00	—	I2BB
16281	72.28	95.28	12.70	—	I2BB	22966	73.03	101.60	11.11	—	I5B.	14499	74.00	90.00	12.00	—	I2BB
—	72.50	92.20	9.00	—	I2BA	22967	73.03	101.60	11.11	—	I2BA	14499	74.00	90.00	12.00	—	I2BA
16197	72.70	120.00	13.00	—	I5BA	12412	73.03	101.60	11.11	—	I5B.	22980	74.00	95.00	10.00	—	I5B.
16197	72.70	120.00	13.00	—	I5BA	15006	73.03	101.60	11.91	—	I5BB	22981	74.00	95.00	13.00	—	I5BA
12914	73.00	90.70	8.00	—	I5BA	15006	73.03	101.60	11.91	—	I5C	11241	74.00	95.00	18.00	—	I3B
11818	73.00	92.00	8.00	—	I2BA	12413	73.03	101.60	12.70	—	I5B.	11241	74.00	95.00	18.00	—	I3B
22946	73.00	95.00	9.00	—	I2BA	22968	73.03	101.60	12.70	—	I5B.	12260	74.00	95.00	18.00	—	I1FC
16355	73.00	95.00	9.50	—	I2B.	13193	73.03	101.60	14.29	—	I2BB	22982	74.00	100.00	13.00	—	I5B.



# Retentores

Perfis - Ver Última Página



INCOVE VEDAÇÕES LTDA.

Cod.	Di	De	Ha1	Ha2	Mod	Cod.	Di	De	Ha1	Ha2	Mod	Cod.	Di	De	Ha1	Ha2	Mod
22983	74.00	101.00	12.00	—	I2BA	23004	75.00	90.00	12.00	—	I5BA	14543	75.00	105.00	13.00	—	I5BB
22984	74.00	102.00	8.00	—	I5BB	23005	75.00	90.00	12.00	—	I5B.	14543	75.00	105.00	13.00	—	I5BB
22985	74.00	104.00	10.00	—	I5BB	12416	75.00	90.00	13.00	—	I5B.	23018	75.00	105.00	13.00	—	I5B.
22986	74.00	108.00	12.50	—	I5B.	14538	75.00	92.00	10.00	—	I5BA	14543	75.00	105.00	13.00	—	I5B
18670	74.00	114.00	11.00	—	I5B.	23006	75.00	92.00	13.00	—	I5B.	23019	75.00	105.00	15.00	—	I5BB
22987	74.00	115.00	6.00	—	I5BB	14782	75.00	95.00	5.00	—	I5BA	12749	75.00	105.56	12.70	—	I2B.
11593	74.00	120.30	9.00	—	I5BA	14782	75.00	95.00	5.00	—	I5BB	21481	75.00	110.00	9.50	—	I5BB
22988	74.22	101.60	6.35	—	I5BB	14782	75.00	95.00	5.00	—	I5BB	23020	75.00	110.00	10.00	—	I5BA
22990	74.50	80.00	6.00	—	I5BB	14782	75.00	95.00	5.00	—	I5BA	14544	75.00	110.00	13.00	—	I5BB
12304	74.50	80.10	22.00	—	ESPE	14782	75.00	95.00	5.00	—	I5B.	14544	75.00	110.00	13.00	—	I5BA
11070	74.50	92.00	11.00	—	I5BB	14539	75.00	95.00	8.00	—	I5BB	14544	75.00	110.00	13.00	—	I5B.
17553	74.61	80.17	14.29	—	I4	23007	75.00	95.00	8.00	—	I5BB	23021	75.00	110.00	13.00	—	I2BA
14684	74.61	88.90	7.94	—	I5BB	14867	75.00	95.00	10.00	—	I5BB	14544	75.00	110.00	13.00	—	I5BB
22991	74.61	90.09	9.53	—	I2BA	14867	75.00	95.00	10.00	—	I5BB	23022	75.00	110.00	15.00	—	I5BB
15319	74.61	90.49	6.35	—	F	14867	75.00	95.00	10.00	—	I5BB	23023	75.00	115.00	10.00	—	I5BB
12915	74.61	92.08	9.53	—	I5BB	14867	75.00	95.00	10.00	—	I5BA	23025	75.00	115.00	10.00	—	I2BB
22992	74.61	92.08	9.53	—	I5B.	23008	75.00	95.00	10.00	—	I5B.	11979	75.00	115.00	13.00	—	I5BB
12811	74.61	92.08	9.53	—	I2B.	14867	75.00	95.00	10.00	—	I5BB	23026	75.00	115.00	13.00	—	I5B.
19093	74.61	92.08	11.11	—	I5BA	14867	75.00	95.00	10.00	—	I5BB	23027	75.00	120.00	13.00	—	I5BA
19093	74.61	92.08	11.11	—	I5B.	11374	75.00	95.00	12.00	—	I5BB	23028	75.00	120.00	15.00	—	I5BA
17346	74.61	95.25	6.35	—	F	23009	75.00	95.00	12.00	—	I2BB	23029	75.00	125.00	15.00	—	I5BA
16601	74.61	95.25	9.53	—	I2B.	11374	75.00	95.00	12.00	—	I5C	13486	75.00	125.00	15.00	—	I2BA
22993	74.61	95.25	12.70	—	I5B.	11374	75.00	95.00	12.00	—	I5BB	23030	75.01	100.01	8.33	—	I5BB
17819	74.61	95.25	12.70	—	I5B	16855	75.00	95.00	13.00	—	I2BB	23031	75.01	101.60	10.32	—	I5BA
17819	74.61	95.25	12.70	—	I5B.	14540	75.00	95.00	13.00	—	I5B	23032	75.01	105.57	12.70	—	I2B.
22994	74.61	98.43	10.00	—	I5B.	14540	75.00	95.00	13.00	—	I5B	23034	75.41	95.25	9.53	—	I2BB
22995	74.61	98.43	10.00	—	I5B.	14540	75.00	95.00	13.00	—	I5BB	15632	75.41	130.20	7.94	—	I815
17105	74.61	98.43	11.91	—	I5B.	23011	75.00	95.00	13.00	—	I5BB	—	76.00	89.70	5.50	—	I5BB
15170	74.61	98.43	15.88	—	I3BC	14540	75.00	95.00	13.00	—	I5B.	23035	76.00	95.00	10.00	—	I5BB
22996	74.61	100.01	12.70	—	I2BA	16855	75.00	95.00	13.00	—	I2BB	13824	76.00	95.00	11.00	—	I2BB
17255	74.61	101.60	9.53	—	F	14540	75.00	95.00	13.00	—	I5C	13824	76.00	95.00	11.00	—	I2BB
15197	74.61	101.60	11.90	—	I5B.	—	75.00	95.00	13.00	—	I2BB	13824	76.00	95.00	11.00	—	I2BB
15197	74.61	101.60	11.91	—	I5BA	11462	75.00	95.00	15.00	—	I5BA	23036	76.00	95.00	15.00	—	I2BB
15197	74.61	101.60	11.91	—	I5C	16794	75.00	98.40	12.00	—	I2B.	12084	76.00	96.50	9.50	—	I5BA
15323	74.61	101.60	12.70	—	I13	16643	75.00	98.50	11.00	—	I5B.	23038	76.00	100.00	10.00	—	I5BB
17005	74.61	101.60	17.46	—	I2B.	12888	75.00	100.00	7.00	—	I4BB	23037	76.00	100.00	10.00	—	I2BB
22997	74.61	101.60	17.46	—	I5B.	14541	75.00	100.00	10.00	—	I5B.	11249	76.00	100.00	13.00	—	I5B.
17436	74.61	101.60	19.05	—	I9B.	14541	75.00	100.00	10.00	—	I5BB	13442	76.00	105.00	12.00	—	I5BB
17436	74.61	101.60	19.05	—	I9BB	14541	75.00	100.00	10.00	—	I5BB	23039	76.00	110.00	12.00	—	I5BB
17436	74.61	101.60	19.05	—	I9C	14541	75.00	100.00	10.00	—	I5BA	13635	76.00	110.00	13.00	—	I5B.
17597	74.61	101.60	19.05	—	I1FC	23012	75.00	100.00	10.00	—	I2BB	13692	76.00	110.00	19.00	—	I1BF
22998	74.61	103.19	12.70	—	I5BB	12774	75.00	100.00	10.00	—	I2BA	11803	76.00	118.00	15.00	—	I5BA
22999	74.61	104.78	14.29	—	I5B.	12774	75.00	100.00	10.00	—	I2B.	23040	76.00	118.00	15.00	—	I5B.
18669	74.61	104.80	6.35	—	I4	—	75.00	100.00	10.00	—	I2BB	23041	76.00	118.00	15.00	—	I2BB
18666	74.61	104.80	14.29	—	I5B.	14542	75.00	100.00	12.00	—	I5BB	23042	76.20	88.90	7.54	—	I2B.
18904	74.61	104.80	19.45	—	I2B.	12774	75.00	100.00	12.00	—	I2BA	12925	76.20	88.90	7.54	—	I2BA
19000	74.61	105.60	12.70	—	I5B.	20290	75.00	100.00	12.00	—	I5BB	12925	76.20	88.90	7.54	—	I2B.
23000	74.61	107.95	15.88	—	I5B.	11078	75.00	100.00	12.00	—	I5BA	12616	76.20	88.90	7.94	—	I5BB
18667	74.61	108.00	15.88	—	I5B.	11078	75.00	100.00	12.00	—	I5B.	16481	76.20	88.90	7.94	—	I2BA
17094	74.61	108.00	19.05	—	I3	23013	75.00	100.00	12.00	—	I2BB	16987	76.20	90.40	7.90	—	I5BB
18668	74.61	111.10	15.88	—	I5B.	14542	75.00	100.00	12.00	—	I5BA	15382	76.20	95.25	6.35	—	F
16131	74.61	114.30	11.11	—	I2B.	14542	75.00	100.00	13.00	—	I5BA	19975	76.20	95.25	9.52	—	I5BB
23001	74.61	114.30	11.91	—	I5B.	12051	75.00	100.00	13.00	—	I2B.	19975	76.20	95.25	9.52	—	I5JM
23002	74.61	114.30	12.70	—	I2B.	14542	75.00	100.00	13.00	—	I5BB	19975	76.20	95.25	9.52	—	I5BA
12415	74.61	114.30	15.88	—	I5C	14542	75.00	100.00	13.00	—	I5BB	16134	76.20	95.25	9.52	—	I2BA
15520	74.61	115.90	11.11	—	F	14542	75.00	100.00	13.00	—	I5BA	23043	76.20	95.25	9.53	—	I5BA
23003	75.00	85.00	7.00	—	I5BB	14542	75.00	100.00	13.00	—	I5B.	23044	76.20	95.25	9.53	—	I2BB
11382	75.00	85.00	9.00	—	I5BB	12051	75.00	100.00	13.00	—	I2BB	13406	76.20	95.25	11.11	—	I2B.
14535	75.00	88.00	7.00	—	I5BB	23015	75.00	100.00	13.00	—	I2BB	17516	76.20	95.25	12.70	—	I5B.
14535	75.00	88.00	7.00	—	I5B.	12051	75.00	100.00	13.00	—	I2BA	22489	76.20	95.25	12.70	—	I2B.
13137	75.00	88.70	12.00	—	I5BB	23014	75.00	100.00	13.00	—	I2BA	17516	76.20	95.25	12.70	—	I5B.
13137	75.00	88.70	12.00	—	I5BA	14542	75.00	100.00	13.00	—	I5BB	17516	76.20	95.25	12.70	—	I5BA
12032	75.00	90.00	8.00	—	I5BB	14542	75.00	100.00	13.00	—	I5BA	17516	76.20	95.25	12.70	—	I5B.
14537	75.00	90.00	10.00	—	I2BB	23016	75.00	100.00	15.00	—	I2B.	13823	76.20	95.30	9.50	—	I5BB
11598	75.00	90.00	10.00	—	I5BB	.....	75.00	100.00	17.00	—	I2BA	19975	76.20	95.30	9.50	—	I5BB
14537	75.00	90.00	12.00	—	I5BA	11557	75.00	101.50	12.00	—	I5BB	22535	76.20	95.40	11.09	—	I2B.
14537	75.00	90.00	12.00	—	I5BB	23017	75.00	102.00	7.00	—	I5B.	13823	76.20	95.48	10.00	—	I5BB



# Retentores

Perfis - Ver Última Página



INCOVE VEDAÇÕES LTDA.

Cod.	Di	De	Ha1	Ha2	Mod	Cod.	Di	De	Ha1	Ha2	Mod	Cod.	Di	De	Ha1	Ha2	Mod
13823	76.20	95.48	10.00	—	I5BB	15734	76.20	108.00	19.05	—	I1	19097	77.79	123.80	14.29	—	I5B.
13219	76.20	98.43	7.94	—	I5BA	23058	76.20	109.93	12.70	—	I5B.	18680	77.79	127.00	11.91	—	I5B.
23046	76.20	98.43	8.33	—	I5BA	18672	76.20	110.30	14.29	—	I5B.	18003	77.80	108.05	19.05	—	I5B.
11647	76.20	98.43	9.53	—	I5BB	18672	76.20	110.30	14.29	—	I5C	23073	78.00	91.00	13.00	—	I2B.
16716	76.20	98.43	11.11	—	I2BA	16862	76.20	111.10	12.70	—	I5B.	12067	78.00	92.00	15.40	—	I5BB
12207	76.20	98.43	11.91	—	I5B.	17199	76.20	111.10	14.29	—	I5B.	13758	78.00	95.00	8.00	—	I5BB
12207	76.20	98.43	11.91	—	I5B.	23059	76.20	111.13	15.88	—	I2B.	22503	78.00	95.00	11.50	—	I5BB
23047	76.20	98.43	11.91	—	I2B.	15978	76.20	112.70	9.53	—	F	11344	78.00	95.00	13.00	—	I5B.
17452	76.20	98.43	12.70	—	I5BB	17174	76.20	112.70	18.27	—	ESPE	23074	78.00	95.00	13.00	—	I2B.
23048	76.20	98.43	12.70	—	I5BA	15756	76.20	114.30	12.70	—	I5JM	14545	78.00	100.00	10.00	—	I5BB
16311	76.20	98.43	12.70	—	I2BB	15756	76.20	114.30	12.70	—	I5B.	23075	78.00	100.00	10.00	—	I5BA
23049	76.20	98.43	12.70	—	I2B.	23060	76.20	114.30	14.29	—	I5B.	14545	78.00	100.00	10.00	—	I5BA
18330	76.20	98.43	18.26	—	ESPE	15974	76.20	114.30	15.88	—	I13	23076	78.00	100.00	12.00	—	I5B.
17747	76.20	98.55	13.00	—	ESPE	19074	76.20	114.30	17.46	—	I813	12221	78.00	100.00	13.00	—	I2BB
18671	76.20	100.00	12.70	—	I5B.	15277	76.20	114.30	20.64	—	I7B.	13575	78.00	100.00	13.00	—	I5BB
23051	76.20	101.60	6.35	—	I5BB	15332	76.20	117.50	12.70	—	I5B.	13575	78.00	100.00	13.00	—	I5B.
17058	76.20	101.60	6.35	—	I5BA	20217	76.20	117.50	14.28	—	I5B.	12221	78.00	100.00	13.00	—	I2BB
15190	76.20	101.60	9.53	—	F	23061	76.20	120.65	14.29	—	I5B.	12221	78.00	100.00	13.00	—	I2BA
11788	76.20	101.60	9.53	—	I2BA	13788	76.20	120.70	13.00	—	I5C	13575	78.00	100.00	13.00	—	I5BB
23052	76.20	101.60	9.53	—	I2BA	19094	76.20	120.70	14.29	—	I5B.	12221	78.00	100.00	13.00	—	I2BA
13264	76.20	101.60	11.10	—	I2B.	18673	76.20	123.80	7.94	—	I13	14546	78.00	105.00	12.00	—	I5BA
13264	76.20	101.60	11.11	—	I5BB	18674	76.20	123.80	15.88	—	I5BA	14546	78.00	105.00	12.00	—	I5BB
23053	76.20	101.60	11.11	—	I5B.	23062	76.20	123.83	7.94	—	I5BB	23077	78.00	105.00	12.00	—	I5B.
13264	76.20	101.60	11.11	—	I2BB	23063	76.20	123.83	15.88	—	I5B.	16265	78.00	105.00	12.50	—	I2BB
13264	76.20	101.60	11.11	—	I2B.	18073	76.20	127.00	11.91	—	I5B.	23079	78.00	105.00	13.00	—	I5B.
15091	76.20	101.60	11.90	—	I5BA	23064	76.20	127.00	12.70	—	I5BB	23080	78.00	108.00	13.00	—	I5BB
15091	76.20	101.60	11.90	—	I5B.	18675	76.20	127.00	22.23	—	I7	23081	78.00	109.00	13.00	—	I5B.
15091	76.20	101.60	11.91	—	I5BB	13908	76.20	133.40	15.87	—	I5C	14547	78.00	110.00	13.00	—	I5BB
15091	76.20	101.60	11.91	—	I5JM	19895	76.20	139.70	12.70	—	I5B.	14547	78.00	110.00	13.00	—	I5BB
15091	76.20	101.60	11.91	—	I5BA	18899	76.20	146.10	6.35	—	I815	23083	78.00	110.00	13.00	—	I5B.
15091	76.20	101.60	11.91	—	I5B.	18945	76.20	152.40	6.35	—	I815	23084	78.00	110.00	13.00	—	I2B.
15091	76.20	101.60	11.91	—	I5C	17854	76.20	157.20	14.29	—	ESPE	23085	78.00	120.00	15.00	—	I5B.
15091	76.20	101.60	11.91	—	I5BB	18329	76.20	158.00	15.08	—	ESPE	13887	78.00	128.00	12.70	—	I5BA
18101	76.20	101.60	12.70	—	I/2	15566	76.20	166.70	14.29	—	ESPE	20309	78.00	140.00	8.00	—	I5JL
17438	76.20	101.60	12.70	—	I80B	F1517	76.20	170.00	12.50	—	ESPE	11780	79.00	97.00	9.00	—	I5B.
17438	76.20	101.60	12.70	—	I80B	15091	76.20	101.60	11.91	—	I5BA	11780	79.00	97.00	9.00	—	I5BA
11980	76.20	101.60	12.70	—	I5BB	15091	76.20	101.60	11.91	—	I5B.	14897	79.00	99.00	8.00	—	I5BB
17438	76.20	101.60	12.70	—	I80C	18946	76.60	127.40	6.35	—	I815	11071	79.00	108.00	12.00	—	I5BB
18302	76.20	101.60	12.70	—	I813	19984	76.99	102.40	12.70	—	I12	25470	79.00	110.00	12.00	—	I5BB
23033	76.20	101.60	13.30	—	I2B.	17818	76.99	110.30	14.29	—	I5B.	13443	79.00	110.00	13.00	—	I5BB
25441	76.20	101.60	15.88	—	I5B.	23065	77.00	95.00	10.00	—	I5B.	12300	79.00	110.00	17.40	—	ESPE
13229	76.20	101.60	15.88	—	I3B.	20091	77.00	96.00	12.00	—	I5BB	23086	79.00	121.00	16.00	—	I5B.
17308	76.20	101.60	15.88	—	I2B.	23066	77.00	100.00	10.00	—	I5B.	23087	79.00	140.00	14.00	—	I2B.
23054	76.20	101.60	17.46	—	I5B.	.....	77.00	100.00	11.50	—	I2BB	11453	79.37	104.77	12.70	—	I2BB
13386	76.20	101.60	17.46	—	I2B.	11989	77.00	101.90	13.00	—	I5B.	15899	79.38	88.90	5.56	—	I4
17051	76.20	101.60	17.86	—	I12B	16500	77.00	110.00	13.00	—	I5B.	18188	79.38	92.08	6.35	—	I5BA
17051	76.20	101.60	17.86	—	I12B	18676	77.79	88.90	3.97	—	I4BA	15949	79.38	95.25	6.35	—	I4B
11795	76.20	101.60	19.05	—	I2BB	17254	77.79	95.25	9.53	—	I5BB	14846	79.38	96.84	8.73	—	I5BA
17436	76.20	101.60	19.05	—	I9BB	17254	77.79	95.25	9.53	—	I5BB	14846	79.38	96.84	8.73	—	I5C
17436	76.20	101.60	19.05	—	I9C	23067	77.79	101.60	9.53	—	I2BA	18682	79.38	98.43	6.35	—	I4
15651	76.20	101.60	19.05	—	I1FC	15317	77.79	101.60	11.11	—	F	23088	79.38	98.43	22.23	—	I5B.
17436	76.20	101.60	19.05	—	I9B.	23068	77.79	103.19	9.53	—	I2BB	15461	79.38	98.43	22.23	—	ESPE
18189	76.20	101.60	23.81	—	I7	17194	77.79	104.80	14.29	—	I5B.	15746	79.38	100.00	12.70	—	I/2
22509	76.20	101.80	11.11	—	I5B.	11431	77.79	108.00	12.70	—	I5BB	23089	79.38	100.01	11.11	—	I5BB
23055	76.20	104.78	14.29	—	I5BA	18677	77.79	108.00	15.87	—	I5B.	18683	79.38	101.60	6.35	—	I4
17528	76.20	104.80	6.35	—	I4	18003	77.79	108.00	19.05	—	I5FC	23090	79.38	101.60	11.11	—	I2B.
17204	76.20	104.80	14.29	—	I5B.	18003	77.79	108.00	19.05	—	I1BF	17603	79.38	101.60	11.91	—	I5BA
17204	76.20	104.80	14.29	—	I5C	18003	77.79	108.00	19.05	—	I1FC	23091	79.38	101.60	11.91	—	I5B.
15553	76.20	104.80	19.05	—	I3B.	13044	77.79	109.50	12.70	—	I5B.	13429	79.38	101.60	11.91	—	I2BA
17077	76.20	104.80	22.23	—	I1	18678	77.79	111.10	15.88	—	I5B.	13429	79.38	101.60	11.91	—	I2B.
15765	76.20	104.80	30.16	—	ESPE	18679	77.79	114.30	11.91	—	I5B.	23093	79.38	101.60	12.70	—	I5BB
23056	76.20	107.95	11.91	—	I5B.	23069	77.79	114.30	12.70	—	I5B.	23092	79.38	101.60	12.70	—	I2BA
23057	76.20	107.95	15.88	—	I5B.	18289	77.79	115.90	12.70	—	I5B.	23094	79.38	101.60	13.49	—	I5B.
17596	76.20	108.00	11.91	—	I5B.	23070	77.79	117.48	14.29	—	I5B.	17341	79.38	101.60	15.88	—	I2BB
15467	76.20	108.00	12.70	—	F	19095	77.79	117.50	14.29	—	I5BB	17341	79.38	101.60	15.88	—	I2B.
15482	76.20	108.00	15.88	—	I5B.	23071	77.79	120.65	14.29	—	I5B.	14720	79.38	101.60	19.05	—	I1FB
15229	76.20	108.00	16.67	—	I3BC	15104	77.79	120.70	30.16	—	I813	14720	79.38	101.60	19.05	—	I1B.





# Retenfores

Perfis - Ver Última Página



INCOLVE VEDAÇÕES LTDA.

Cod.	Di	De	Ha1	Ha2	Mod	Cod.	Di	De	Ha1	Ha2	Mod	Cod.	Di	De	Ha1	Ha2	Mod
14720	79.38	101.60	19.05	—	11FC	17136	79.38	112.70	12.70	—	15BB	11448	80.00	95.00	10.00	—	15BB
23095	79.38	102.79	9.53	—	12BB	17136	79.38	112.70	12.70	—	15B.	23121	80.00	95.00	10.00	—	15BA
23096	79.38	102.79	11.11	—	15BB	17136	79.38	112.70	12.70	—	15BB	16575	80.00	95.00	12.00	—	15BB
17514	79.38	103.20	11.11	—	15BB	23108	79.38	112.71	11.91	—	15BB	23122	80.00	95.00	12.00	—	15BB
17514	79.38	103.20	11.11	—	15B.	23107	79.38	112.71	11.91	—	15BA	16575	80.00	95.00	12.00	—	12BB
23097	79.38	104.78	9.53	—	15BB	23109	79.38	112.71	11.91	—	15B.	14548	80.00	95.00	12.00	—	15BB
23098	79.38	104.78	12.70	—	12B.	15815	79.38	114.30	11.91	—	15B.	16681	80.00	96.00	8.00	—	15BB
23099	79.38	104.78	15.88	—	15BA	15815	79.38	114.30	11.91	—	15C	23123	80.00	96.00	11.00	—	15BB
18681	79.38	104.80	7.94	—	14B.	15215	79.38	114.30	12.70	—	15BB	12417	80.00	96.00	12.00	—	15BB
16080	79.38	104.80	9.50	—	15BB	23111	79.38	114.30	12.70	—	15BB	—	80.00	100.00	8.00	—	12BB
11445	79.38	104.80	11.11	—	15B.	23112	79.38	114.30	12.70	—	15B.	14549	80.00	100.00	9.50	—	15BB
15020	79.38	104.80	12.70	—	15B.	13196	79.38	114.30	12.70	—	12B.	14549	80.00	100.00	10.00	—	15BA
18684	79.38	104.80	12.70	—	180	15215	79.38	114.30	12.70	—	15C	14549	80.00	100.00	10.00	—	15BB
15020	79.38	104.80	12.70	—	15B.	23113	79.38	114.30	14.29	—	15B.	12855	80.00	100.00	10.00	—	12BA
12809	79.38	104.80	12.70	—	12BB	23114	79.38	114.30	15.08	—	12B.	12855	80.00	100.00	10.00	—	12BB
12809	79.38	104.80	12.70	—	12B.	18688	79.38	114.30	15.08	—	13BC	14549	80.00	100.00	10.00	—	15BB
15020	79.38	104.80	12.70	—	15C	14080	79.38	114.30	16.67	—	ESPE	14549	80.00	100.00	10.00	—	15BA
15020	79.38	104.80	12.70	—	15BB	18289	79.38	115.90	12.70	—	15BA	14549	80.00	100.00	10.00	—	15B.
13249	79.38	104.80	14.29	—	15BB	18289	79.38	115.90	12.70	—	15B.	14549	80.00	100.00	10.00	—	15B.
13249	79.38	104.80	14.29	—	15B.	15751	79.38	115.90	17.46	—	113	12855	80.00	100.00	10.00	—	12BB
13250	79.38	104.80	14.29	—	12B.	14077	79.38	115.90	19.45	—	ESPE	12855	80.00	100.00	10.00	—	12BB
13249	79.38	104.80	14.29	—	15BA	15007	79.38	115.90	31.75	—	ESPE	14549	80.00	100.00	10.00	—	15BB
13250	79.38	104.80	14.29	—	12BA	15007	79.38	115.90	31.75	—	ESPE	13507	80.00	100.00	11.00	—	15BB
13250	79.38	104.80	14.29	—	12B.	15007	79.38	115.90	31.75	—	15C	—	80.00	100.00	12.00	—	12BA
13250	79.38	104.80	14.29	—	12BA	18141	79.38	115.90	34.93	—	SANF	—	80.00	100.00	12.00	—	12BB
13249	79.38	104.80	14.29	—	15C	23115	79.38	117.48	14.29	—	15B.	23124	80.00	100.00	12.00	—	15B.
17510	79.38	104.80	15.87	—	15BA	15196	79.38	117.50	14.29	—	15B.	23126	80.00	100.00	12.00	—	12BB
17408	79.38	104.80	44.45	—	ESPE	15196	79.38	117.50	14.29	—	15BB	11972	80.00	100.00	12.00	—	12BA
23100	79.38	105.17	9.92	—	15BB	15196	79.38	117.50	14.29	—	15C	—	80.00	100.00	12.00	—	15BA
23101	79.38	107.95	11.91	—	12B.	15196	79.38	117.50	19.45	—	15BB	—	80.00	100.00	12.00	—	12BB
23102	79.38	107.95	14.29	—	15BB	12726	79.38	118.00	12.70	—	12B.	14550	80.00	100.00	13.00	—	15BB
23103	79.38	107.95	15.88	—	15BB	17339	79.38	119.10	31.75	—	ESPE	14760	80.00	100.00	13.00	—	12B.
23104	79.38	107.95	15.88	—	12B.	23116	79.38	120.65	12.70	—	15B.	14550	80.00	100.00	13.00	—	15BB
18906	79.38	108.00	6.35	—	15BB	14893	79.38	120.70	9.53	—	15C	14550	80.00	100.00	13.00	—	15BB
18906	79.38	108.00	6.35	—	15BA	15817	79.38	120.70	15.88	—	15B.	14550	80.00	100.00	13.00	—	15BA
18906	79.38	108.00	6.35	—	15BA	15817	79.38	120.70	15.88	—	15C	14550	80.00	100.00	13.00	—	15B.
17865	79.38	108.00	12.70	—	F	18689	79.38	120.70	20.64	—	12	14760	80.00	100.00	13.00	—	12BB
14837	79.38	108.00	12.70	—	12B.	19098	79.38	123.80	12.70	—	15B.	14760	80.00	100.00	13.00	—	12BA
15582	79.38	108.00	14.29	—	14BB	23117	79.38	123.83	12.70	—	15B.	23125	80.00	100.00	13.00	—	12B.
13272	79.38	108.00	14.29	—	15BB	23118	79.38	123.83	14.29	—	15B.	14550	80.00	100.00	13.00	—	15BB
15582	79.38	108.00	14.29	—	14C	18690	79.38	125.40	15.88	—	15B.	14550	80.00	100.00	13.00	—	15B.
17495	79.38	108.00	14.29	—	ESPE	23119	79.38	127.00	11.91	—	15BB	11830	80.00	100.00	14.00	—	12BB
15582	79.38	108.00	14.29	—	ESPE	15645	79.38	127.00	11.91	—	15C	14709	80.00	101.00	12.50	—	15BB
15108	79.38	108.00	15.80	—	15BA	11784	79.38	127.00	12.70	—	15B.	14709	80.00	101.00	12.50	—	15BB
15108	79.38	108.00	15.88	—	15BB	17611	79.38	127.00	15.88	—	15B.	12075	80.00	102.00	14.00	—	12BA
15108	79.38	108.00	15.88	—	15B.	18691	79.38	127.00	15.88	—	13	23127	80.00	105.00	11.00	—	15BA
15108	79.38	108.00	15.88	—	15C	13548	79.38	127.00	15.88	—	12BF	23128	80.00	105.00	11.00	—	15BA
17007	79.38	108.00	19.05	—	13B.	15688	79.38	133.40	11.91	—	15C	15020	80.00	105.00	12.00	—	15C
19011	79.38	108.00	22.23	—	11BF	15915	79.38	139.70	6.35	—	1815	11381	80.00	105.00	13.00	—	15BB
18685	79.38	108.00	25.40	—	19	13171	79.38	149.20	53.98	—	11FC	23130	80.00	105.00	13.00	—	15B.
18692	79.38	111.10	10.70	—	15BA	17185	79.38	190.50	12.70	—	ESPE	14553	80.00	105.00	13.00	—	12BB
18692	79.38	111.10	10.70	—	15BA	17351	79.38	206.40	12.70	—	ESPE	14553	80.00	105.00	13.00	—	12BA
11041	79.38	111.10	11.11	—	12B.	14072	79.38	209.60	12.70	—	ESPE	23129	80.00	105.00	13.00	—	12B.
18686	79.38	111.10	12.70	—	180	17863	79.38	209.60	12.70	—	ESPE	23131	80.00	105.00	18.50	—	15BA
13285	79.38	111.10	12.70	—	15BA	17869	79.38	209.60	13.49	—	ESPE	12630	80.00	105.40	12.70	—	15B.
15389	79.38	111.10	12.70	—	F	13588	79.38	209.60	22.23	—	ESPE	14554	80.00	106.00	14.00	—	15B.
13285	79.38	111.10	12.70	—	15BA	17447	79.38	209.60	25.40	—	ESPE	14554	80.00	106.00	14.00	—	15BA
15850	79.38	111.10	15.88	—	F	23120	79.50	104.50	7.00	—	12BB	16529	80.00	108.00	6.00	—	14BA
15176	79.38	111.10	15.88	—	15BB	16836	79.50	111.30	15.50	—	15JM	16529	80.00	108.00	6.00	—	14BA
15176	79.38	111.10	15.88	—	15B.	11290	80.00	90.00	10.00	—	15BB	23152	80.00	108.00	16.00	—	15B
15551	79.38	111.10	15.88	—	11BF	11520	80.00	92.00	12.00	—	15BB	23132	80.00	108.00	16.00	—	12B.
18687	79.38	111.10	19.05	—	13	13624	80.00	95.00	5.00	—	14BA	23133	80.00	108.00	19.00	—	12BB
15065	79.38	111.10	27.78	—	19B.	16748	80.00	95.00	5.00	—	15BB	14555	80.00	109.00	13.00	—	15B.
23105	79.38	111.13	14.29	—	15B.	20186	80.00	95.00	5.00	—	12BB	16928	80.00	110.00	10.00	—	15BB
15212	79.38	111.50	12.70	—	ESPE	20186	80.00	95.00	5.00	—	12BB	23134	80.00	110.00	10.00	—	15BA
23106	79.38	111.52	10.32	—	15BA	11321	80.00	95.00	7.00	—	14BB	16772	80.00	110.00	10.00	—	12BA
15133	79.38	112.70	11.11	—	F	11448	80.00	95.00	8.00	—	15BB	23135	80.00	110.00	10.50	—	12BA



# Retentores

Perfis - Ver Última Página



INCOVE VEDAÇÕES LTDA.

Cod.	Di	De	Ha1	Ha2	Mod	Cod.	Di	De	Ha1	Ha2	Mod	Cod.	Di	De	Ha1	Ha2	Mod
14556	80.00	110.00	12.00	—	15BB	15757	80.96	115.90	17.46	—	1813	18907	82.55	101.60	19.05	—	11BF
14556	80.00	110.00	12.00	—	15BB	13112	80.96	116.70	17.46	—	180B	18164	82.55	103.20	4.76	—	F
23137	80.00	110.00	12.00	—	15BA	23159	80.96	117.48	11.11	—	15B.	23172	82.55	104.78	14.29	—	15B.
23136	80.00	110.00	12.00	—	15B.	23160	80.96	117.48	14.29	—	15B.	23173	82.55	104.78	24.21	—	12B.
23138	80.00	110.00	12.00	—	15B.	15294	80.96	117.50	11.11	—	113	18165	82.55	104.80	4.76	—	F
22563	80.00	110.00	12.00	—	12BB	15294	80.96	117.50	11.11	—	113	14039	82.55	104.80	9.52	—	12B.
14556	80.00	110.00	12.00	—	15BA	15294	80.96	117.50	11.11	—	113	13457	82.55	104.80	12.70	—	15B.
14556	80.00	110.00	12.00	—	15BB	13307	80.96	117.50	12.70	—	15B.	13457	82.55	104.80	12.70	—	15C
14556	80.00	110.00	13.00	—	15B.	15307	80.96	117.50	14.29	—	15B	15675	82.55	104.80	23.80	—	12B.
23139	80.00	110.00	13.00	—	15BA	15307	80.96	117.50	14.29	—	15C	15675	82.55	104.80	23.81	—	19C
23140	80.00	110.00	14.00	—	15BA	15263	80.96	117.50	14.30	—	ESP.	15675	82.55	104.80	23.81	—	19B.
20242	80.00	110.00	15.00	—	15BB	15263	80.96	117.50	19.05	—	ESPE	23174	82.55	106.36	11.91	—	15BB
11639	80.00	110.00	16.00	—	15JM	15263	80.96	117.50	19.05	—	15C	18163	82.55	106.40	9.52	—	F
.....	80.00	112.00	18.00	—	12BA	19099	80.96	120.70	11.91	—	15BA	23175	82.55	107.95	9.53	—	12BB
12418	80.00	114.50	12.70	—	15B	19099	80.96	120.70	11.91	—	15BA	23176	82.55	107.95	11.11	—	12B.
12418	80.00	114.50	12.70	—	15B.	16124	80.96	120.70	14.29	—	15B.	23178	82.55	107.95	11.91	—	15BB
16110	80.00	115.00	10.00	—	15BB	19100	80.96	123.80	12.70	—	15B.	23177	82.55	107.95	11.91	—	12B.
14557	80.00	115.00	12.00	—	15B.	11045	80.96	123.80	14.29	—	15BB	23179	82.55	107.95	12.70	—	15BA
23142	80.00	115.00	13.00	—	15BA	23160	80.96	123.83	12.70	—	15B.	13328	82.55	107.95	12.70	—	12BA
23143	80.00	115.00	14.00	—	15B.	23161	80.96	127.00	11.11	—	15BB	23181	82.55	107.95	14.28	—	15B.
14558	80.00	117.00	15.00	—	15BA	15857	80.96	127.00	11.11	—	14	15569	82.55	107.95	15.88	—	15B.
20311	80.00	120.00	12.00	—	15BB	17622	80.96	127.00	11.90	—	15C	15569	82.55	107.95	15.88	—	15BB
23144	80.00	120.00	13.00	—	15BB	23162	80.96	127.00	11.91	—	15BB	23185	82.55	107.95	19.05	—	12B.
14559	80.00	120.00	13.00	—	15B.	17623	80.96	127.00	11.91	—	15B.	11406	82.55	108.00	9.52	—	12BB
23145	80.00	120.00	15.00	—	15BA	17623	80.96	127.00	11.91	—	15C	12074	82.55	108.00	9.53	—	15BA
16929	80.00	125.00	13.00	—	15BB	15606	80.96	127.00	19.05	—	ESPE	20329	82.55	108.00	12.70	—	15JL
23146	80.00	125.00	13.00	—	15B.	17831	80.96	127.00	23.81	—	1813	11225	82.55	108.00	12.70	—	15BB
23147	80.00	125.00	13.00	—	12B.	15960	80.96	130.20	22.23	—	11BF	11225	82.55	108.00	12.70	—	15B.
11181	80.00	128.00	12.00	—	15BB	17617	80.96	138.10	14.29	—	15B.	11793	82.55	108.00	19.05	—	15B
16454	80.00	133.50	45.00	—	TDUO	23163	81.00	100.00	10.00	—	15B.	17035	82.55	108.00	19.05	—	15FC
17821	80.17	96.84	9.53	—	F	23164	81.00	100.00	10.00	—	12BB	18296	82.55	108.00	19.05	—	12B.
17900	80.17	98.43	11.91	—	15B.	20198	82.00	95.00	5.00	—	14BB	17035	82.55	108.00	19.05	—	11FC
23148	80.17	98.43	11.91	—	15BB	20198	82.00	95.00	5.00	—	14BB	11406	82.55	108.00	—	—	12BA
17900	80.17	98.43	11.91	—	15BA	23165	82.00	100.00	12.00	—	15BB	13327	82.55	108.05	14.29	—	15C
20075	80.17	104.78	14.29	—	12B.	18693	82.00	104.70	14.30	—	15B	13327	82.55	108.05	14.29	—	15B.
23149	80.17	107.95	11.91	—	15BB	18693	82.00	104.70	14.30	—	15B.	13327	82.55	108.05	14.29	—	15BB
18037	80.17	139.70	12.70	—	ESPE	11216	82.00	104.77	13.50	—	15BB	18694	82.55	110.30	6.35	—	14BA
18037	80.17	139.70	12.70	—	180C	12294	82.00	105.00	12.00	—	12BB	15136	82.55	111.10	9.52	—	F
22483	80.95	108.50	15.88	—	15BB	23167	82.00	105.00	12.00	—	12BB	17735	82.55	111.10	11.11	—	15BA
19901	80.96	104.80	12.70	—	15B.	14560	82.00	105.00	13.00	—	15BA	13362	82.55	111.10	14.28	—	15BB
15783	80.96	104.80	17.46	—	13BC	14560	82.00	105.00	13.00	—	15BB	13362	82.55	111.10	14.28	—	15B.
23150	80.96	107.95	9.53	—	15B.	14560	82.00	105.00	13.00	—	15BA	14745	82.55	111.10	14.28	—	ESPE
23151	80.96	107.95	11.91	—	15B.	14560	82.00	105.00	13.00	—	15B.	17112	82.55	111.10	15.87	—	15B.
23152	80.96	107.95	15.88	—	15B	14560	82.00	105.00	13.00	—	15C	13652	82.55	111.10	15.87	—	12B.
23153	80.96	107.95	19.05	—	12B.	23168	82.00	105.00	15.00	—	12BB	18695	82.55	111.10	19.05	—	13B.
18013	80.96	108.00	9.53	—	113	12294	82.00	105.40	12.00	—	12BB	23186	82.55	111.13	11.11	—	15B.
16751	80.96	108.00	9.53	—	15B.	11419	82.00	110.00	13.00	—	15B.	13362	82.55	111.14	14.20	—	15BB
15024	80.96	108.00	11.11	—	F	14561	82.00	110.00	14.00	—	15BA	15479	82.55	112.70	9.52	—	F
16293	80.96	108.00	12.70	—	15BB	14561	82.00	110.00	14.00	—	15B.	13693	82.55	112.70	11.90	—	15C
16119	80.96	108.00	12.70	—	12BB	16871	82.00	115.00	13.00	—	15BB	17160	82.55	112.70	12.70	—	15BB
17157	80.96	108.00	14.29	—	15B.	23169	82.00	120.00	12.00	—	12B.	17160	82.55	112.70	12.70	—	15BA
16140	80.96	108.00	14.29	—	12B.	14911	82.00	120.00	13.00	—	15B.	15564	82.55	112.70	12.70	—	15C
17016	80.96	108.00	19.05	—	11FB	23170	82.00	130.00	10.00	—	15BB	15393	82.55	112.70	13.89	—	1813
18290	80.96	108.00	19.05	—	12C	16044	82.50	100.00	9.00	—	15BB	23189	82.55	113.51	12.70	—	15B.
16413	80.96	111.10	15.88	—	15B.	14030	82.50	107.95	16.00	—	ESPE	16234	82.55	114.30	11.11	—	15C
17338	80.96	111.10	30.16	—	112B	13194	82.50	108.00	11.90	—	12B.	15177	82.55	114.30	11.90	—	15C
23154	80.96	111.13	15.88	—	12B.	13195	82.50	108.00	11.90	—	15B.	15177	82.55	114.30	11.90	—	15B.
17169	80.96	112.70	13.49	—	1813	13195	82.50	108.00	11.91	—	15BA	13978	82.55	114.30	11.90	—	12BB
23155	80.96	112.71	11.91	—	15B.	—	82.50	120.00	15.00	—	12BA	15177	82.55	114.30	11.90	—	15C
18013	80.96	114.30	9.53	—	113	RB11	82.50	120.00	15.00	—	1Z	15177	82.55	114.30	11.90	—	15C
15400	80.96	114.30	11.91	—	15B.	12325	82.50	134.60	41.20	—	ESPE	12222	82.55	114.30	12.70	—	12B.
15400	80.96	114.30	11.91	—	15B.	16600	82.55	101.60	11.90	—	12B	12222	82.55	114.30	12.70	—	12B.
23156	80.96	114.30	11.91	—	15B.	23171	82.55	101.60	12.70	—	15BB	13286	82.55	114.30	12.70	—	15BB
15400	80.96	114.30	11.91	—	15C	15909	82.55	101.60	12.70	—	15BA	13286	82.55	114.30	12.70	—	15B.
23158	80.96	114.30	12.70	—	15BB	15909	82.55	101.60	12.70	—	15BA	12222	82.55	114.30	12.70	—	12BA
23157	80.96	114.30	12.70	—	15B.	15909	82.55	101.60	12.70	—	15C	13286	82.55	114.30	12.70	—	15BB
17265	80.96	115.10	7.94	—	F	12564	82.55	101.60	19.05	—	17B.	13286	82.55	114.30	12.70	—	15C





# Retenfores

Perfis - Ver Última Página



INCOVE VEDAÇÕES LTDA.

Cod.	Di	De	Ha1	Ha2	Mod	Cod.	Di	De	Ha1	Ha2	Mod	Cod.	Di	De	Ha1	Ha2	Mod
13786	82.55	114.30	12.70	—	I3BC	23203	84.14	107.95	15.88	—	I5B.	23220	85.00	110.00	12.00	—	I5B.
15652	82.55	114.30	14.28	—	I80B	17052	84.14	108.00	6.35	—	F	11157	85.00	110.00	12.00	—	I2BB
15652	82.55	114.30	14.28	—	I80C	18351	84.14	108.00	15.87	—	I5JM	13246	85.00	110.00	13.00	—	I2BA
23190	82.55	114.30	15.88	—	I5B.	18700	84.14	111.10	12.70	—	I5BB	13875	85.00	110.00	13.00	—	I80B
15168	82.55	114.30	17.46	—	I3B.	18700	84.14	111.10	12.70	—	I5B.	14564	85.00	110.00	13.00	—	I5BB
13373	82.55	114.30	20.64	—	I2BC	23204	84.14	111.13	9.13	—	I2BA	14564	85.00	110.00	13.00	—	I5BA
17832	82.55	117.50	12.70	—	I5CC	23205	84.14	111.13	12.70	—	I5B.	14564	85.00	110.00	13.00	—	I5B.
17832	82.55	117.50	12.70	—	I5C	23206	84.14	111.13	15.88	—	I5B.	13246	85.00	110.00	13.00	—	I2BB
23191	82.55	119.06	12.70	—	I5B.	22538	84.14	114.30	12.70	—	I5BB	23221	85.00	110.00	13.00	—	I2BA
18696	82.55	119.10	12.70	—	I5B.	23207	84.14	114.30	12.70	—	I2B.	23222	85.00	110.00	13.00	—	I2B.
16637	82.55	119.10	12.70	—	I2B.	15870	84.14	114.30	15.87	—	I5B.	13246	85.00	110.00	13.00	—	I2BA
23192	82.55	119.85	11.91	—	I5B.	15870	84.14	114.30	15.87	—	I5B.	13508	85.00	110.00	14.00	—	I5BB
17162	82.55	119.90	11.90	—	I5B.	18042	84.14	119.10	12.70	—	I2/L	23224	85.00	110.00	14.00	—	I5BB
18697	82.55	119.90	16.67	—	I2B.	18701	84.14	120.70	15.87	—	I5B.	13508	85.00	110.00	14.00	—	I2BA
22440	82.55	120.65	15.87	—	I2B.	19104	84.14	123.80	12.70	—	I5B.	11307	85.00	110.00	15.00	—	I5JM
23193	82.55	120.65	15.88	—	I2B.	17317	84.14	127.00	11.90	—	I5B.	11307	85.00	110.00	15.00	—	I5B.
16501	82.55	120.70	11.91	—	I5BA	17598	84.14	127.00	22.22	—	I1	18190	85.00	110.00	21.00	—	I121
17189	82.55	120.70	12.70	—	I8B	19105	84.14	130.20	12.70	—	I5B.	23225	85.00	112.00	14.00	—	I5BB
17303	82.55	120.70	12.70	—	I813	19106	84.14	133.40	12.70	—	I5B.	23227	85.00	115.00	13.00	—	I5BB
18698	82.55	120.70	15.87	—	I5B.	17652	84.14	139.70	14.29	—	I5B.	23226	85.00	115.00	13.00	—	I5B.
19891	82.55	122.20	12.70	—	I5B.	11853	84.50	100.00	6.30	—	I5BB	16831	85.00	115.00	14.00	—	I5B.
19101	82.55	123.80	14.29	—	I5B.	15483	84.93	104.00	6.35	—	F	14565	85.00	115.00	15.00	—	I5B.
13720	82.55	123.80	15.87	—	I2B.	23208	84.93	104.78	9.53	—	I2BA	16377	85.00	115.00	16.00	—	I5BB
18246	82.55	123.80	15.87	—	I3BC	23209	84.93	130.18	12.70	—	I2BB	16377	85.00	115.00	16.00	—	I5JM
14834	82.55	123.80	15.87	—	I1BF	16863	85.00	100.00	7.00	—	I2BB	12766	85.00	117.70	14.50	—	I2B.
17570	82.55	123.80	19.05	—	F	12904	85.00	100.00	9.00	—	I5BB	23228	85.00	120.00	10.00	—	I5B.
23194	82.55	123.83	12.70	—	I5B.	23210	85.00	100.00	9.00	—	I5BA	23230	85.00	120.00	12.00	—	I5BB
17588	82.55	127.00	11.11	—	F	11995	85.00	100.00	10.00	—	I5BB	23229	85.00	120.00	12.00	—	I5BA
15139	82.55	127.00	11.90	—	I5B.	23211	85.00	100.00	12.00	—	I5BB	12926	85.00	120.00	12.00	—	I2BB
15139	82.55	127.00	11.90	—	I5C	20343	85.00	100.00	12.00	—	I2BA	23234	85.00	120.00	13.00	—	I5BB
17111	82.55	127.00	15.08	—	I3	12904	85.00	100.00	13.00	—	I5BB	23231	85.00	120.00	13.00	—	I5B.
17562	82.55	127.00	22.22	—	I1	13712	85.00	100.00	13.00	—	I5BB	13787	85.00	120.00	15.00	—	I5B.
19102	82.55	130.20	12.70	—	I5B.	23212	85.00	100.00	13.00	—	I5B.	13787	85.00	120.00	15.00	—	I5BA
23195	82.55	133.35	14.29	—	I5BA	13712	85.00	100.00	13.00	—	I5BB	25462	85.00	120.00	15.00	—	I2BB
18699	82.55	133.40	12.70	—	I5B.	16130	85.00	102.00	13.00	—	I5BA	23232	85.00	120.00	17.00	—	I2BA
13795	82.55	146.10	15.87	—	I5C	23213	85.00	102.00	13.00	—	I5B.	23233	85.00	121.00	12.00	—	I5BB
15667	82.55	152.40	12.70	—	I2/L	11819	85.00	105.00	10.00	—	I5BB	23235	85.00	125.00	13.00	—	I5B.
17592	82.55	190.50	12.70	—	D12F	14732	85.00	105.00	10.00	—	I5BA	14566	85.00	130.00	13.00	—	I5BA
17352	82.55	206.40	12.70	—	D7F	14732	85.00	105.00	10.00	—	I5BA	14566	85.00	130.00	13.00	—	I5B.
15252	82.55	209.60	12.70	—	DISC	14732	85.00	105.00	10.00	—	I5BB	12973	85.00	130.00	13.00	—	I2JM
23196	83.00	79.00	8.00	—	I5BB	14732	85.00	105.00	10.00	—	I5B.	20038	85.00	140.00	12.00	—	I5BB
16826	83.00	101.60	6.10	—	I5C	12419	85.00	105.00	10.00	—	I2BA	17160	85.55	112.70	12.70	—	I5BA
12921	83.00	103.00	10.00	—	I5BB	—	85.00	105.00	10.00	—	I5BA	.....	85.70	107.85	12.70	—	I5B.
25458	83.00	105.00	10.00	—	I5BB	—	85.00	105.00	10.00	—	I5BA	22428	85.70	111.28	9.50	—	I2BA
25459	83.00	105.00	10.00	—	I2BB	—	85.00	105.00	11.00	—	I2BB	12253	85.70	114.20	11.20	—	I2BB
11017	83.00	105.00	12.00	—	I2BB	11499	85.00	105.00	12.00	—	I5BB	22555	85.72	108.05	11.88	—	I2BA
12456	83.00	108.00	15.00	—	I5B.	12295	85.00	105.00	12.00	—	I2BA	11433	85.73	95.25	9.52	—	I5B.
11240	83.00	110.00	10.00	—	I5B.	.....	85.00	105.00	12.00	—	I2BB	11433	85.73	95.25	9.52	—	I5B.
12613	83.00	111.00	14.10	—	I5BB	11499	85.00	105.00	12.00	—	I5BB	18702	85.73	101.60	11.90	—	I5B.
23197	83.00	111.00	15.50	—	I5B.	12295	85.00	105.00	12.00	—	I2BB	19001	85.73	104.80	6.35	—	I4B.
23198	83.00	124.00	13.00	—	I5BB	14563	85.00	105.00	13.00	—	I5BB	17622	85.73	104.80	9.52	—	I5B.
23199	83.34	101.60	8.33	—	I5BA	14563	85.00	105.00	13.00	—	I5BB	18184	85.73	104.80	12.70	—	I5BB
12530	84.00	102.00	7.00	—	I5JL	14563	85.00	105.00	13.00	—	I5BA	23236	85.73	107.95	15.88	—	I5B.
12170	84.00	104.00	22.00	—	ESPE	14563	85.00	105.00	13.00	—	I5B.	12333	85.73	108.00	7.90	14.60	ESPE
23200	84.00	105.00	13.00	—	I5BB	23216	85.00	105.00	13.00	—	I2BA	12333	85.73	108.00	7.90	14.60	ESPE
23200	84.00	105.00	13.00	—	I5B.	23217	85.00	105.00	15.00	—	I5BB	11363	85.73	108.00	12.70	—	I5BB
12728	84.00	108.00	16.00	—	I5BB	12296	85.00	105.40	12.00	—	I2BB	14845	85.73	108.00	14.29	—	ESPE
23201	84.00	110.00	12.00	—	I5B.	12296	85.00	105.40	12.00	—	I2BB	17648	85.73	108.00	15.87	—	I5BB
14562	84.00	110.00	16.00	—	I5BB	23218	85.00	108.00	8.00	—	I5BB	17648	85.73	108.00	15.87	—	I5B.
14763	84.14	101.60	14.29	—	I7B.	20063	85.00	108.00	13.00	—	I4BB	17648	85.73	108.00	15.87	—	I5C
23202	84.14	104.78	14.29	—	I5B.	20301	85.00	110.00	7.00	—	I5BB	17583	85.73	111.10	9.52	—	F
13724	84.14	104.80	7.94	—	I4BA	14829	85.00	110.00	8.00	—	I5BB	14071	85.73	111.10	9.52	—	I5B.
11501	84.14	104.80	12.70	—	I5BB	12420	85.00	110.00	12.00	—	I5BB	18109	85.73	111.10	12.70	—	F
17443	84.14	104.80	14.29	—	I5BB	12420	85.00	110.00	12.00	—	I5BB	13297	85.73	111.10	14.29	—	I5BB
17443	84.14	104.80	14.29	—	I5B.	11157	85.00	110.00	12.00	—	I2BB	13297	85.73	111.10	14.29	—	I5B.
11457	84.14	104.80	14.29	—	I2BB	12420	85.00	110.00	12.00	—	I5BB	15180	85.73	111.10	15.80	—	I5B
11769	84.14	106.40	11.90	—	I5BA	12420	85.00	110.00	12.00	—	I5BB	15180	85.73	111.10	15.87	—	I5B.



# Retentores

Perfis - Ver Última Página



INCOVE VEDAÇÕES LTDA.

Cod.	Di	De	Ha1	Ha2	Mod	Cod.	Di	De	Ha1	Ha2	Mod	Cod.	Di	De	Ha1	Ha2	Mod
18104	85.73	111.10	15.87	---	I2B	11683	86.70	120.00	12.00	---	I5C	12677	88.00	115.00	13.00	---	I5B.
17517	85.73	111.10	19.05	---	I3BC	12823	87.00	108.00	9.50	---	I5BB	23272	88.00	120.00	13.00	---	I5B.
11482	85.73	111.10	22.22	---	I5B.	12823	87.00	108.00	9.50	---	I5BB	13095	88.00	125.00	13.00	---	I5BB
17691	85.73	111.10	22.22	---	I1CF	23255	87.00	110.00	13.00	---	I5B.	23273	88.00	126.00	13.00	---	I5BB
23237	85.73	111.13	9.53	---	I5BA	13667	87.00	115.00	12.00	---	I5BA	14528	88.00	128.00	12.00	---	I5BB
23238	85.73	111.13	9.53	---	I2BA	12669	87.00	124.00	12.80	---	I5BA	---	88.00	128.00	12.00	---	I5BB
23239	85.73	111.13	11.91	---	I5BA	23256	87.00	130.00	12.70	---	I5BB	11079	88.00	150.50	13.00	---	I5BB
23240	85.73	111.13	12.70	---	I5BB	14050	87.30	114.30	22.22	---	I1FB	12085	88.50	104.50	8.00	---	I5BA
22441	85.73	111.13	12.70	---	I2BB	15379	87.31	103.20	12.70	---	F	12324	88.90	99.00	39.10	---	ESPE
23241	85.73	111.13	14.29	---	I5B.	23257	87.31	107.95	9.53	---	I2BA	23275	88.90	104.78	9.53	---	I2BA
15524	85.73	114.30	11.11	---	F	14744	87.31	108.00	9.52	---	I2BA	23276	88.90	104.78	12.70	---	I5BB
23242	85.73	114.30	11.11	---	I2BB	17442	87.31	108.00	15.87	---	I5B.	18713	88.90	104.80	6.35	---	I4BA
23243	85.73	114.30	11.91	---	I5B.	17442	87.31	108.00	15.87	---	I5C	11042	88.90	104.80	11.11	---	I5B.
14045	85.73	114.30	12.70	---	IDI	14035	87.31	108.00	15.87	---	I1CF	23277	88.90	107.95	6.35	---	I5BB
13329	85.73	114.30	12.70	---	I5B.	18706	87.31	111.10	15.87	---	I5B.	23278	88.90	107.95	9.92	---	I5BB
13329	85.73	114.30	12.70	---	I5C	13473	87.31	111.11	9.52	---	I5C	15813	88.90	108.00	11.11	---	I5BA
13106	85.73	114.30	12.70	---	I80B	23258	87.31	114.30	9.53	---	I2BA	15813	88.90	108.00	11.11	---	I5B.
23245	85.73	114.30	14.29	---	I5BA	23259	87.31	114.30	11.11	---	I5B.	12676	88.90	108.00	12.70	---	I5BB
23244	85.73	114.30	14.29	---	I5B.	15657	87.31	114.30	11.90	---	I5B.	11699	88.90	108.00	15.87	---	I5B.
15647	85.73	114.30	14.29	---	I5B.	15657	87.31	114.30	11.90	---	I5C	16567	88.90	110.00	12.70	---	I7BB
15647	85.73	114.30	14.29	---	I5C	23260	87.31	114.30	11.91	---	I2B.	23279	88.90	110.00	13.00	---	I5B.
15579	85.73	114.30	15.88	---	I5BB	23261	87.31	114.30	12.70	---	I5BB	18663	88.90	111.10	9.52	---	I5BB
14703	85.73	114.30	17.46	---	I3B.	23262	87.31	114.30	14.29	---	I5BB	18663	88.90	111.10	9.52	---	I5JM
17311	85.73	114.30	19.05	---	I2B.	16804	87.31	114.30	15.87	---	I2BA	18663	88.90	111.10	9.52	---	I5BB
18025	85.73	117.47	20.65	---	I9C	17151	87.31	114.30	22.22	---	I1FB	12960	88.90	111.10	11.11	---	I5BA
17171	85.73	117.50	14.29	---	I813	17151	87.31	114.30	22.22	---	I1CF	13458	88.90	111.10	11.11	---	I2BA
15579	85.73	117.50	15.88	---	I5B.	18707	87.31	117.50	11.90	---	I80B	13458	88.90	111.10	11.11	---	I2B.
23246	85.73	119.06	12.70	---	I5B.	16181	87.31	117.50	12.70	---	I5JM	18712	88.90	111.10	11.90	---	I5B.
15401	85.73	119.10	12.70	---	I5BB	16181	87.31	117.50	12.70	---	I5JM	18712	88.90	111.10	11.90	---	ESPE
15401	85.73	119.10	12.70	---	I5B.	18708	87.31	117.50	15.87	---	I5B.	13460	88.90	111.10	12.70	---	I2B.
15401	85.73	119.10	12.70	---	I5C	16967	87.31	117.50	15.87	---	I2B.	22325	88.90	111.10	14.20	---	I2B
18703	85.73	119.90	11.90	---	I5BA	23263	87.31	120.65	12.70	---	I2BA	16662	88.90	111.10	14.29	---	I5BB
18703	85.73	119.90	11.90	---	I5B.	23264	87.31	120.65	14.29	---	I5BB	13459	88.90	111.10	14.29	---	I2B.
15762	85.73	119.90	22.22	---	I1BF	23265	87.31	120.65	14.29	---	I5B.	13533	88.90	111.10	15.87	---	I5B.
18200	85.73	120.70	12.70	---	I5B.	16270	87.31	120.70	12.70	---	I2BA	17307	88.90	111.10	19.00	---	I9C
18198	85.73	120.70	19.05	---	I1	19110	87.31	120.70	14.20	---	I5BB	17307	88.90	111.10	19.05	---	I9BB
19017	85.73	123.80	12.70	---	I5B.	19110	87.31	120.70	14.20	---	I5B.	17307	88.90	111.12	6.35	---	I4B.
14832	85.73	127.00	6.35	---	I4B.	19110	87.31	120.70	14.20	---	I5B.	23280	88.90	111.13	9.53	---	I5BA
23247	85.73	127.00	11.91	---	I5B.	19110	87.31	120.70	14.20	---	I5C	23281	88.90	111.13	9.53	---	I2BA
15496	85.73	127.00	12.70	---	I5BB	19110	87.31	120.70	14.29	---	I5BA	23282	88.90	111.13	10.72	---	I5B.
23248	85.73	127.00	12.70	---	I2BA	19110	87.31	120.70	14.29	---	I5B.	23283	88.90	111.13	12.70	---	I5BB
15496	85.73	127.00	12.70	---	I5C	19110	87.31	120.70	14.29	---	I5BB	23284	88.90	111.13	12.70	---	I2B.
18704	85.73	127.00	14.29	---	I80B	18709	87.31	122.20	19.05	---	I7	11882	88.90	111.28	9.53	---	I2BA
18705	85.73	127.00	22.22	---	I1	17386	87.31	123.80	15.87	---	I5B.	17643	88.90	112.70	11.11	---	I8
19108	85.73	130.20	12.70	---	I5B.	18710	87.31	123.80	22.22	---	I1	15601	88.90	114.30	2.38	---	CORT
12049	85.73	131.80	12.70	---	I5C	23266	87.31	123.83	15.88	---	I5BA	15088	88.90	114.30	6.35	---	I4B.
19109	85.73	133.40	12.70	---	I5B.	17384	87.31	127.00	11.11	---	F	13263	88.90	114.30	6.35	---	I5BB
23249	85.73	146.05	15.88	---	I5BA	17313	87.31	127.00	11.90	---	I5B.	23285	88.90	114.30	6.35	---	I5BB
17906	85.73	146.10	15.87	---	I5B.	14856	87.31	128.60	11.90	---	I5BB	15088	88.90	114.30	6.35	---	I4C
14862	85.73	150.80	13.49	---	I815	14856	87.31	128.60	11.90	---	I5BB	13263	88.90	114.30	6.35	---	I5BB
15955	85.73	151.60	17.46	---	DISC	15900	87.31	130.20	12.70	---	I5B.	12865	88.90	114.30	9.52	---	I2BA
15668	85.73	152.40	9.92	---	I1/2L	23267	87.31	133.35	12.70	---	I5B.	23286	88.90	114.30	9.70	---	I2BA
18258	85.73	152.40	14.29	---	I80	18711	87.31	133.40	12.70	---	I5B.	23287	88.90	114.30	9.92	---	I5B.
13923	85.80	123.80	13.00	---	I5C	17387	87.31	139.70	14.29	---	I5B.	17001	88.90	114.30	11.90	---	I5B.
.....	85.90	104.00	11.00	---	I2BB	12729	87.50	104.50	8.00	---	I5BB	17001	88.90	114.30	11.90	---	I5BA
11942	86.00	95.00	7.00	10.00	RASP	12944	87.50	121.00	6.35	---	I4BA	17001	88.90	114.30	11.90	---	I5B.
13885	86.00	108.00	10.00	---	I5BA	23268	88.00	105.00	8.00	---	I5BB	23288	88.90	114.30	11.91	---	I5BB
13885	86.00	108.00	10.00	---	I5BA	23269	88.00	110.00	10.00	---	I5BB	23289	88.90	114.30	11.91	---	I2B.
20255	86.00	108.90	10.30	---	I2BA	13783	88.00	110.00	10.00	---	I5BA	12421	88.90	114.30	12.70	---	I5B.
23250	86.00	110.00	13.00	---	I5BB	20120	88.00	110.00	12.00	---	I5BA	12421	88.90	114.30	12.70	---	I5BB
23251	86.00	110.00	16.00	---	I5B.	20120	88.00	110.00	12.00	---	I5BB	12421	88.90	114.30	12.70	---	I5JM
16757	86.00	110.00	16.50	---	I5JM	16089	88.00	110.00	12.80	---	I5B.	12421	88.90	114.30	12.70	---	I5JL
23252	86.00	115.00	12.00	---	I5BB	14568	88.00	110.00	13.00	---	I5BA	12421	88.90	114.30	12.70	---	I5B.
16978	86.00	120.00	13.00	---	I5JL	14568	88.00	110.00	13.00	---	I5BB	12195	88.90	114.30	12.70	---	I2BB
23253	86.00	120.00	14.00	---	I5BB	23270	88.00	110.00	13.00	---	I5B.	12195	88.90	114.30	12.70	---	I2BA
23254	86.52	111.13	12.70	---	I5B.	14568	88.00	110.00	13.00	---	I5BB	12195	88.90	114.30	12.70	---	I2B.
13329	86.60	114.42	12.70	---	I5C	23271	88.00	115.00	12.00	---	I5BA	13220	88.90	114.30	12.70	---	I7JM





Cod.	Di	De	Ha1	Ha2	Mod	Cod.	Di	De	Ha1	Ha2	Mod	Cod.	Di	De	Ha1	Ha2	Mod
12421	88.90	114.30	12.70	—	I5BA	15761	88.90	133.40	14.29	—	ESPE	20224	90.00	120.00	12.00	—	I5BB
12421	88.90	114.30	12.70	—	I5C	19111	88.90	136.50	12.70	—	I5BA	23324	90.00	120.00	12.00	—	I5BA
17323	88.90	114.30	14.29	—	F	23307	88.90	139.70	14.29	—	I5BB	.....	90.00	120.00	12.00	—	I2BA
17256	88.90	114.30	15.08	—	I2B.	18722	88.90	139.70	14.29	—	I5B.	23323	90.00	120.00	12.00	—	I5B.
15234	88.90	114.30	15.87	—	I5B	18723	88.90	146.10	14.29	—	I5B.	11299	90.00	120.00	12.00	—	I2BB
15216	88.90	114.30	15.87	—	I3B.	15595	88.90	149.20	15.87	—	I814	23325	90.00	120.00	12.00	—	I2BA
15216	88.90	114.30	15.87	—	I3BC	23308	88.90	150.81	15.88	—	I5BB	.....	90.00	120.00	12.00	—	I2BB
15234	88.90	114.30	15.87	—	I5C	15627	88.90	152.40	19.05	—	I813	14572	90.00	120.00	13.00	—	I2BB
23292	88.90	114.30	15.88	—	I5BB	15584	88.90	152.40	23.81	—	I813	14572	90.00	120.00	13.00	—	I2BB
13385	88.90	114.30	20.64	—	I2BC	23309	88.90	159.00	15.00	—	I5B.	14572	90.00	120.00	13.00	—	I2BB
23293	88.90	114.30	21.03	—	I5B.	17344	88.90	168.30	14.29	—	D12F	14571	90.00	120.00	13.00	—	I5BB
17962	88.90	114.30	22.22	—	I1FB	15769	88.90	206.40	14.29	—	D12F	14572	90.00	120.00	13.00	—	I2BB
23294	88.90	114.30	22.23	—	I2B.	15228	88.90	215.90	11.11	—	D7F	14571	90.00	120.00	13.00	—	I5BB
15751	88.90	115.90	12.70	—	I13	20212	89.00	102.00	9.00	—	I2BB	14571	90.00	120.00	13.00	—	I5JL
15992	88.90	115.90	12.70	—	I5B.	14892	89.00	109.00	8.00	—	I5BB	23328	90.00	120.00	13.00	—	I5BA
17232	88.90	115.90	17.46	—	I3	14892	89.00	109.00	8.00	—	I5B.	14571	90.00	120.00	13.00	—	I5B.
23295	88.90	117.48	12.70	—	I5BA	11735	89.00	110.40	9.00	—	I5BB	23326	90.00	120.00	13.00	—	I2BA
23296	88.90	117.48	17.46	—	I2B.	.....	89.00	114.25	12.70	—	I2B.	14571	90.00	120.00	13.00	—	I5B.
15181	88.90	117.50	15.87	—	I5B.	16412	89.00	121.00	6.30	—	I5BB	14571	90.00	120.00	13.00	—	I5B.
18714	88.90	117.50	17.46	—	I3	17220	89.69	108.00	19.05	—	I1BF	12425	90.00	120.00	14.00	—	I5BB
17224	88.90	119.10	11.11	—	F	12030	90.00	100.00	8.00	—	I5BB	12425	90.00	120.00	14.00	—	I5B.
15782	88.90	119.10	31.75	—	ESPE	16165	90.00	100.00	10.00	—	I5BB	16667	90.00	120.00	14.00	—	I2BB
23297	88.90	120.00	13.00	—	I5B.	20207	90.00	100.00	12.00	—	I5BB	23330	90.00	120.00	15.00	—	I5BB
23299	88.90	120.65	9.53	—	I5B.	11943	90.00	102.00	7.00	—	I5BB	22525	90.00	120.00	15.00	—	I5B.
23298	88.90	120.65	9.53	—	I2BA	16986	90.00	104.00	8.00	11.00	ESPE	20118	90.00	120.00	15.00	—	I2BA
23300	88.90	120.65	12.70	—	I2BA	11842	90.00	105.00	5.00	—	I4BA	23331	90.00	120.00	21.00	—	I2B.
18929	88.90	120.70	6.35	—	I4B.	23312	90.00	105.00	12.00	—	I2BB	16074	90.00	122.00	12.50	—	I5JL
16715	88.90	120.70	9.50	—	I2BA	12470	90.00	108.00	13.00	—	I4BB	20216	90.00	124.00	16.00	—	I5B.
15129	88.90	120.70	11.11	—	F	11619	90.00	108.00	13.00	—	I5BB	14573	90.00	125.00	13.00	—	I5B.
17375	88.90	120.70	12.70	—	I5BB	23313	90.00	110.00	8.00	—	I2BB	12426	90.00	125.00	13.00	—	I2BB
17375	88.90	120.70	12.70	—	I5JM	12550	90.00	110.00	8.00	—	I5BA	16284	90.00	125.00	15.00	—	I5BA
17375	88.90	120.70	12.70	—	I5B.	RB02	90.00	110.00	10.00	—	I5B.	23332	90.00	125.00	17.00	—	I2B.
17728	88.90	120.70	14.29	—	I5BB	23314	90.00	110.00	10.00	—	I5BB	20185	90.00	130.00	12.00	—	I5JL
17728	88.90	120.70	14.29	—	I5B.	23315	90.00	110.00	10.00	—	I2BB	20185	90.00	130.00	12.00	—	I5JM
11109	88.90	120.70	14.29	—	I7BA	16983	90.00	110.00	10.00	—	I7BB	11983	90.00	130.00	13.00	—	I5B.
15198	88.90	120.70	15.87	—	I5B.	25399	90.00	110.00	10.00	—	ESPE	22572	90.00	130.00	15.00	—	I2B.
15529	88.90	120.70	15.87	—	I13	13897	90.00	110.00	12.00	—	I5BB	12485	90.00	133.00	13.00	—	I5BA
15198	88.90	120.70	15.87	—	I5B.	13897	90.00	110.00	12.00	—	I5BB	20208	90.00	140.00	13.00	—	I5BB
15198	88.90	120.70	15.87	—	I5C	11332	90.00	110.00	12.00	—	I2BB	20208	90.00	140.00	13.00	—	I5BB
18715	88.90	120.70	15.87	—	I3B.	13897	90.00	110.00	12.00	—	I5BB	23333	90.00	140.00	13.00	—	I5B.
17828	88.90	120.70	15.87	—	I12B	11332	90.00	110.00	12.00	—	I2BB	20346	90.00	140.00	13.00	—	I2BA
17828	88.90	120.70	15.87	—	I12C	14672	90.00	110.00	13.00	—	I2BA	16823	90.00	162.00	15.00	—	I5BB
13461	88.90	120.70	20.64	—	I2B.	14672	90.00	110.00	13.00	—	I2BA	23334	90.00	162.00	15.00	—	I5BB
17587	88.90	123.00	22.22	—	ESPE	14569	90.00	110.00	13.00	—	I5JL	23310	90.00	.....	12.00	—	I5BA
18717	88.90	123.80	15.87	—	I5BA	14569	90.00	110.00	13.00	—	I5BB	.....	90.10	110.00	13.00	—	I2BB
18716	88.90	123.80	22.22	—	I1	14569	90.00	110.00	13.00	—	I5BA	15770	90.49	103.20	4.76	—	I815
14899	88.90	123.80	23.81	—	ESPE	14569	90.00	110.00	13.00	—	I5B.	17306	90.49	104.80	6.35	—	I4B.
23301	88.90	123.83	15.88	—	I5BB	23316	90.00	110.00	13.00	—	I2BB	17822	90.49	106.40	7.14	—	F
18720	88.90	127.00	6.35	—	I5B.	14569	90.00	110.00	13.00	—	I5BB	23335	90.49	107.95	12.70	—	I5BB
15512	88.90	127.00	11.11	—	F	11259	90.00	110.00	14.00	—	I2BA	17161	90.49	108.00	6.35	—	CORT
23302	88.90	127.00	11.11	—	I5B.	23317	90.00	110.00	15.00	—	I5B.	19973	90.49	111.10	9.52	—	I5BB
15235	88.90	127.00	11.90	—	I5BB	13204	90.00	110.00	15.00	—	I2BB	19973	90.49	111.10	9.52	—	I5B.
13299	88.90	127.00	11.90	—	I2B.	13204	90.00	110.00	15.00	—	I2BB	14799	90.49	111.10	34.93	—	ESPE
23303	88.90	127.00	11.91	—	I5B.	23318	90.00	111.00	7.00	—	I5BB	13041	90.49	112.70	12.70	—	I5B
15235	88.90	127.00	12.70	—	I5B.	23319	90.00	112.00	14.00	—	I5BB	13041	90.49	112.70	12.70	—	I5B
23304	88.90	127.00	12.70	—	I5B.	22493	90.00	112.66	13.00	—	I5B.	13041	90.49	112.70	12.70	—	I5B.
15235	88.90	127.00	12.70	—	I5C	11601	90.00	115.00	9.00	—	I5B.	13041	90.49	112.70	12.70	—	I5BA
12424	88.90	127.00	15.87	—	I5B.	14511	90.00	115.00	12.00	—	I5BA	23335	90.49	114.30	11.51	—	I2B.
18719	88.90	127.00	16.67	—	I2	14570	90.00	115.00	12.00	—	I5B.	18724	90.49	114.30	11.90	—	I5B.
15565	88.90	127.00	17.46	—	ESPE	14570	90.00	115.00	12.00	—	I5BB	23336	90.49	114.30	11.91	—	I2B.
18718	88.90	127.00	19.05	—	I12	14570	90.00	115.00	12.00	—	I5BA	22551	90.49	114.30	12.70	—	I2BA
17614	88.90	127.00	22.22	—	I1	23320	90.00	115.00	13.00	—	I5BB	23337	90.49	114.30	12.70	—	I2B.
23305	88.90	130.18	11.91	—	I2BB	11736	90.00	115.00	13.00	—	I2BB	23338	90.49	114.30	14.29	—	I5BB
15836	88.90	130.20	12.70	—	I5B.	16359	90.00	115.00	13.00	—	I5B.	18725	90.49	114.30	15.08	—	I2B.
15836	88.90	130.20	12.70	—	I5B.	23321	90.00	115.00	13.50	—	I5B.	23340	90.49	114.49	15.08	—	I2B.
23306	88.90	133.35	12.70	—	I5B.	16940	90.00	118.00	12.00	—	I2B.	23341	90.49	117.48	12.70	—	I5B.
18721	88.90	133.40	11.90	—	I5B.	23322	90.00	120.00	8.00	—	I5BA	17613	90.49	117.50	14.29	—	I5C



# Retenfores

Perfis - Ver Última Página



INCOVE VEDAÇÕES LTDA.

Cod.	Di	De	Ha1	Ha2	Mod	Cod.	Di	De	Ha1	Ha2	Mod	Cod.	Di	De	Ha1	Ha2	Mod
23342	90.49	120.65	15.88	---	I5B.	13437	92.08	123.80	12.70	---	I5B.	11990	95.00	110.00	9.00	---	I5BB
23343	90.49	120.65	21.03	---	I2B.	18112	92.08	123.80	14.29	---	I5BB	11990	95.00	110.00	9.00	---	I5BA
13654	90.49	120.70	9.52	---	I5B.	18112	92.08	123.80	14.29	---	I5B.	16210	95.00	110.00	12.00	---	I5BB
18726	90.49	120.70	15.87	---	I5BB	17239	92.08	123.80	15.87	---	I5B.	16210	95.00	110.00	13.00	---	I5BB
15188	90.49	123.80	11.11	---	F	17239	92.08	123.80	15.87	---	I5BB	14708	95.00	110.00	13.00	---	I5BA
17490	90.49	123.80	15.87	---	I5B.	17844	92.08	123.80	15.87	19.00	ESPE	14708	95.00	110.00	13.00	---	I5BA
15334	90.49	123.80	20.64	---	I2B.	17844	92.08	123.80	15.87	---	ESPE	12428	95.00	111.00	17.00	---	I5B.
17474	90.49	127.00	15.87	---	I5B.	17239	92.08	123.80	15.87	---	I5C	13778	95.00	115.00	8.00	---	I2L
23344	90.49	127.00	15.88	---	I5B.	14663	92.08	123.80	20.64	---	I2B.	16078	95.00	115.00	11.00	---	I5BB
18727	90.49	127.00	22.22	---	I1	15701	92.08	123.80	20.64	---	I3B	23375	95.00	115.00	13.00	---	I2BB
19112	90.49	130.20	12.70	---	I5B.	14663	92.08	123.80	20.64	---	I2C	14577	95.00	115.00	13.00	---	I5BB
19113	90.49	133.40	12.70	---	I5B.	17465	92.08	123.80	22.22	---	I1CF	23375	95.00	115.00	13.00	---	I2BB
19114	90.49	136.50	12.70	---	I5B.	23361	92.08	123.83	15.88	---	I5BB	14577	95.00	115.00	13.00	---	I5BB
19115	90.49	139.70	12.70	---	I5B.	23360	92.08	123.83	15.88	---	I5B.	14577	95.00	115.00	13.00	---	I5BA
17897	90.49	139.70	31.75	---	ESPE	23362	92.08	123.83	21.03	---	I2B.	14577	95.00	115.00	13.00	---	I5B.
17576	90.49	146.10	14.29	---	I5BB	13576	92.08	127.00	11.90	---	I2B.	14577	95.00	115.00	13.00	---	I5BB
12797	91.00	105.00	8.00	---	I5BB	23363	92.08	127.00	11.91	---	I5B.	12506	95.00	120.00	10.00	---	I5JM
12559	91.00	121.00	12.00	---	I5BB	11399	92.08	127.00	12.70	---	I5B.	12838	95.00	120.00	12.00	---	I5BB
12761	91.00	127.00	16.00	---	ESPE	18728	92.08	127.00	16.67	---	I3B.	12690	95.00	120.00	12.00	---	I5B
25395	91.00	133.00	9.00	---	I2B.	23364	92.08	127.00	16.67	---	I2B.	12690	95.00	120.00	12.00	---	I5BA
17353	91.69	127.00	20.64	---	I5B.	14751	92.08	127.00	19.84	---	I7B.	12838	95.00	120.00	12.00	---	I2BB
17353	91.69	127.00	20.64	---	I5C	18729	92.08	127.00	26.19	---	I9B.	20336	95.00	120.00	12.00	---	I9B.
20288	92.00	102.00	11.00	0.80	I5BB	18143	92.08	127.80	44.40	---	SANT	14578	95.00	120.00	13.00	---	I5BB
14574	92.00	102.00	12.00	---	I5BA	15213	92.08	128.60	23.81	---	ESPE	14578	95.00	120.00	13.00	---	I5BB
11418	92.00	104.50	10.00	---	I5BA	17742	92.08	131.80	20.64	---	I3B.	14578	95.00	120.00	13.00	---	I5BA
25409	92.00	105.35	12.00	---	I5BB	23365	92.08	133.35	15.88	---	I5B.	14578	95.00	120.00	13.00	---	I5B.
23345	92.00	106.00	8.00	---	I5BB	18094	92.08	133.40	15.87	---	I5C	11805	95.00	120.00	13.00	---	I2BB
23346	92.00	115.00	10.00	---	I5BB	19116	92.08	136.50	12.70	---	I5B.	23376	95.00	120.00	13.00	---	I2B.
23347	92.00	115.00	12.00	---	I5BB	19117	92.08	139.70	12.70	---	I5B.	14578	95.00	120.00	13.00	---	I5BA
23348	92.00	117.00	15.00	---	I5BA	12427	92.08	150.80	13.49	---	I815	16668	95.00	120.00	14.00	---	I5B
23349	92.00	120.00	12.00	---	I5B.	18309	92.08	155.60	9.52	---	I4B.	23377	95.00	120.00	14.00	---	I5B.
14575	92.00	120.00	13.00	---	I5BB	11425	92.08	161.90	12.70	---	I5BA	11544	95.00	120.00	15.00	---	I5BB
13020	92.00	120.00	13.00	---	I2BA	---	92.10	107.70	10.00	---	I2BB	23378	95.00	121.00	12.00	---	I2BB
23350	92.00	120.00	14.00	---	I5B.	15840	92.25	133.40	14.29	---	I5B.	23379	95.00	122.00	12.00	---	I5BB
14575	92.00	120.00	15.00	---	I5B.	15305	92.47	120.65	16.66	---	ESPE	11317	95.00	124.00	15.00	---	I5BA
14534	92.00	125.00	13.00	---	I5BB	18730	92.47	120.70	6.35	---	I4	23380	95.00	125.00	8.00	---	I5BB
14534	92.00	125.00	13.00	---	I5C	23366	93.00	101.00	16.00	---	I5BA	11371	95.00	125.00	10.00	---	I5BB
15640	92.00	126.85	12.70	---	I5B.	11832	93.00	108.00	6.50	---	I4BA	23381	95.00	125.00	12.00	---	I5BB
15640	92.00	126.85	12.70	---	I5C	20129	93.00	110.00	12.00	---	I2BB	16296	95.00	125.00	12.00	---	I2BB
16878	92.00	127.00	12.70	---	I5JM	23367	93.00	110.00	13.00	---	I5B.	16296	95.00	125.00	12.00	---	I2BA
12884	92.00	140.00	7.00	---	I2BA	14042	93.00	110.00	14.00	---	I5B.	14579	95.00	125.00	13.00	---	I5BB
15881	92.08	108.00	11.11	---	I2L	.....	93.00	157.00	7.40	---	ESPE	14579	95.00	125.00	13.00	---	I5BB
18351	92.08	108.00	15.87	---	I5JM	17071	93.30	130.00	13.00	---	I5BB	14579	95.00	125.00	13.00	---	I5B.
25468	92.08	111.10	9.53	---	I2BA	18353	93.66	114.30	11.90	---	I5B.	23383	95.00	125.00	13.00	---	I5BA
13920	92.08	114.30	11.90	---	I2BB	11095	93.66	117.50	18.00	---	I3C	23382	95.00	125.00	13.00	---	I5B.
18083	92.08	114.30	12.70	---	I5BB	23368	93.66	120.65	6.35	---	I5BA	14579	95.00	125.00	13.00	---	I5C
18083	92.08	114.30	12.70	---	I5B.	25407	93.66	120.65	11.11	---	I5BB	12531	95.00	125.00	13.00	---	I7BB
23351	92.08	114.30	12.70	---	I2B.	25419	93.66	120.65	11.11	---	I2JL	23384	95.00	125.00	15.00	---	I5B.
18083	92.08	114.30	12.70	---	I5C	23369	93.66	120.65	14.29	---	I5B.	11581	95.00	125.00	16.00	---	I5JM
23352	92.08	114.30	15.88	---	I5B.	23370	93.66	120.65	15.88	---	I5B.	20397	95.00	130.00	10.00	---	I5BA
12833	92.08	114.31	11.91	---	I2BB	18047	93.66	120.70	11.11	---	I5B.	17071	95.00	130.00	13.00	---	I5B
23353	92.08	117.48	9.53	---	I5BA	11489	93.66	120.70	12.70	---	I2B.	17071	95.00	130.00	13.00	---	I5B
23354	92.08	117.48	11.11	---	I5B.	18928	93.66	123.80	14.29	---	I5BA	17071	95.00	130.00	13.00	---	I5B.
23355	92.08	117.48	11.11	---	I2B.	17483	93.66	127.00	11.90	---	I5B.	17071	95.00	130.00	13.00	---	I5BB
23356	92.08	117.48	12.70	---	I5BA	17190	93.66	128.60	12.70	---	F	23385	95.00	130.00	13.00	---	I5B.
11880	92.08	117.50	9.52	---	I5BA	23372	93.66	130.18	13.49	---	I5BA	17071	95.00	130.00	13.00	---	I5BA
15237	92.08	117.50	14.29	---	I5B.	18355	93.66	130.20	12.70	---	I5BA	17071	95.00	130.00	13.00	---	I5BA
13300	92.08	117.50	15.87	---	I5C	18355	93.66	130.26	12.70	---	I5BA	17071	95.00	130.00	13.00	---	I5BA
18008	92.08	117.50	19.05	---	I2B.	23373	93.66	133.35	12.70	---	I2B.	16495	95.00	130.00	15.00	---	I5BB
18191	92.08	120.30	7.94	---	I5BA	19118	93.66	133.40	12.70	---	I5B.	23386	95.00	130.00	15.00	---	I5B.
14807	92.08	120.65	15.88	---	I5B.	19119	93.66	136.50	12.70	---	I5B.	23387	95.00	135.00	15.00	---	I5B.
23358	92.08	120.65	15.88	---	I2BB	18731	93.66	139.70	14.29	---	I5B.	16958	95.00	145.00	8.00	---	I5BB
19998	92.08	120.70	12.70	---	I80B	12192	94.00	120.00	12.70	---	I2B.	25384	95.00	145.00	13.00	---	I2BB
16185	92.08	120.70	15.87	---	I2BB	23374	94.00	120.00	13.00	---	I5B.	23388	95.00	162.00	17.00	---	I5BB
17246	92.08	123.00	12.70	---	I5BB	12843	94.40	114.00	10.00	---	I8BB	RB03	95.00	180.50	14.00	---	I5B.
16720	92.08	123.00	12.70	---	I2BA	25396	95.00	109.00	11.00	---	I2BA	12885	95.25	114.30	9.52	---	I5BA
23359	92.08	123.03	12.70	---	I5B.	11721	95.00	110.00	8.00	---	I5BA	12885	95.25	114.30	9.52	---	I5BA



# Retentores

Perfis - Ver Última Página



INCOVE VEDAÇÕES LTDA.

Cod.	Di	De	Ha1	Ha2	Mod	Cod.	Di	De	Ha1	Ha2	Mod	Cod.	Di	De	Ha1	Ha2	Mod
14007	95.25	114.30	11.11	—	I2B.	23399	95.25	150.02	12.70	—	I5BB	18198	98.43	120.70	19.05	—	I1
—	95.25	114.30	11.11	—	I2B.	11569	95.25	152.40	12.70	—	I5BB	18224	98.43	123.80	9.52	—	I5B.
16129	95.25	114.30	11.90	—	I2B.	14858	95.25	161.90	7.46	—	I5BB	13248	98.43	123.80	12.70	—	I5B.
17882	95.25	114.30	15.87	—	F	14858	95.25	161.90	17.46	—	I5BB	13334	98.43	123.80	14.29	—	I5C
13038	95.25	119.10	12.70	—	I5BA	.....	95.30	114.25	12.00	—	I2B.	15648	98.43	123.80	15.87	—	I5B.
23391	95.25	120.65	9.53	—	I2BA	16824	95.30	120.50	12.70	—	I5B.	17053	98.43	123.80	15.87	—	F
23392	95.25	120.65	11.11	—	I2B.	23400	96.00	120.00	8.00	—	I5B.	15994	98.43	123.80	15.87	—	I12C
23393	95.25	120.65	12.70	—	I2BB	23401	96.00	120.00	13.00	—	I5BB	18919	98.43	123.80	22.22	—	I1
17241	95.25	120.65	12.70	—	I5BA	23402	96.00	120.00	14.00	—	I5BB	23421	98.43	123.83	12.70	—	I5B.
11992	95.25	120.65	15.80	—	I2B.	11891	96.00	121.00	12.00	—	I5BB	23422	98.43	123.83	14.29	—	I5B.
19893	95.25	120.70	9.52	—	I5BB	23403	96.00	125.00	13.00	—	I5B.	23423	98.43	123.83	19.84	—	I5B.
19893	95.25	120.70	9.52	—	I5BB	RB11	96.00	135.70	12.00	—	I2	23424	98.43	127.00	11.11	—	I5BB
15165	95.25	120.70	11.11	—	F	23404	96.00	136.00	14.00	—	I5BB	15943	98.43	127.00	11.90	—	I5B.
17241	95.25	120.70	12.70	—	I5BB	11711	96.00	137.00	18.00	—	I5BA	15943	98.43	127.00	11.90	—	I5BB
17241	95.25	120.70	12.70	—	I5B.	16976	96.00	140.00	13.00	—	I5BB	15943	98.43	127.00	11.90	—	I5B.
17241	95.25	120.70	12.70	—	I5JL	12777	96.00	140.60	13.00	—	I5BA	15943	98.43	127.00	11.90	—	I5C
17241	95.25	120.70	12.70	—	I5BB	13561	96.04	114.30	6.35	—	I4BA	15805	98.43	127.00	12.70	—	I80B
17241	95.25	120.70	12.70	—	I5JM	23405	96.04	127.00	11.91	—	I5B.	12475	98.43	127.00	12.70	—	I5BB
17241	95.25	120.70	12.70	—	I5BA	23406	96.04	162.32	14.29	—	I5BB	12475	98.43	127.00	12.70	—	I5BB
17241	95.25	120.70	12.70	—	I5B.	23407	96.44	127.00	12.70	—	I2B.	15805	98.43	127.00	12.70	—	ESPE
11455	95.25	120.70	12.70	—	I2BB	17575	96.84	117.50	15.87	—	I5B.	18312	98.43	127.00	16.67	—	I2B.
11692	95.25	120.70	12.70	—	ESPE	23408	96.84	120.65	15.88	—	I5B.	23425	98.43	130.18	15.88	—	I5B.
13381	95.25	120.70	15.87	—	I5B.	18734	96.84	120.70	15.87	—	I5BB	15459	98.43	130.20	15.87	—	I5BB
17829	95.25	120.70	15.87	—	I12B	16297	96.84	123.80	12.70	—	I5BB	15459	98.43	130.20	15.87	—	I5JM
17829	95.25	120.70	15.87	—	I12C	17608	96.84	123.80	15.87	—	I5B.	15459	98.43	130.20	15.87	—	I5C
14704	95.25	120.70	19.00	—	I2B.	18138	96.84	125.40	15.87	—	I813	15459	98.43	130.20	15.87	—	I5B.
14704	95.25	120.70	19.05	—	I2B.	18735	96.84	127.00	11.90	—	I5C	23426	98.43	133.11	11.11	—	I5B.
14797	95.25	120.70	19.50	—	I5BB	17097	96.84	128.60	9.52	—	F	23427	98.43	133.35	11.91	—	I5B.
17348	95.25	120.70	22.22	—	I1FB	19122	96.84	130.20	12.70	—	I5B.	12609	98.43	133.40	11.90	—	I5BA
17833	95.25	120.70	22.22	—	I9C	23410	96.84	133.35	111.91	—	I5BA	15853	98.43	133.40	15.87	—	I5B.
17045	95.25	123.80	15.87	—	I5B.	15075	96.84	133.40	11.90	—	I5B.	17584	98.43	136.50	9.52	—	F
17618	95.25	123.80	17.46	—	I12B	16079	96.84	133.40	15.87	—	I2B.	15946	98.43	136.50	12.70	—	I5BB
17618	95.25	123.80	17.46	—	I12C	15063	96.84	133.40	15.87	—	I3BC	14062	98.43	136.50	12.70	—	I2B.
17599	95.25	123.80	22.22	—	I1CF	19125	96.84	136.50	12.70	—	I5BB	15946	98.43	136.50	12.70	—	I5C
23394	95.25	123.83	15.88	—	I2B.	23411	96.84	136.53	12.70	—	I5B.	16161	98.43	137.00	10.00	—	I813
18732	95.25	125.00	15.87	—	I5B.	19126	96.84	139.70	12.70	—	I5B.	15408	98.43	138.10	11.11	—	I5B.
23395	95.25	125.02	11.91	—	I2B.	15109	96.84	142.90	9.52	—	F	23428	98.43	138.11	11.11	—	I5BB
15653	95.25	127.00	11.90	—	I5BB	13662	97.00	120.00	13.00	—	I5B.	19127	98.43	139.70	12.70	—	I5B.
15653	95.25	127.00	11.90	—	I5B.	14580	97.00	126.00	25.00	—	I1FB	23428	98.43	140.49	15.88	—	I5B.
15224	95.25	127.00	11.90	—	I4	16430	97.50	119.00	10.00	—	I5BB	18153	98.43	141.30	12.70	—	F
15653	95.25	127.00	11.90	—	I5C	.....	97.80	116.00	16.00	—	ESPE	15704	98.43	142.90	20.64	—	I2C
15653	95.25	127.00	11.91	—	I5B.	16411	98.00	110.00	10.00	—	I5BB	23429	98.43	144.46	19.05	—	I5BB
15189	95.25	127.00	12.70	—	F	23412	98.00	116.00	8.00	—	I5B.	15009	98.43	144.50	19.05	—	I5B.
17589	95.25	127.00	12.70	—	F	13591	98.00	120.00	13.00	—	I5BB	15009	98.43	144.50	19.05	—	I5BA
11403	95.25	127.00	12.70	—	I5B.	14581	98.00	120.00	13.00	—	I5BB	15009	98.43	144.50	19.05	—	I5B.
19038	95.25	127.00	14.29	—	I80	14581	98.00	120.00	13.00	—	I5B.	15009	98.43	144.50	19.05	—	I5C
18733	95.25	127.00	16.67	—	I2BA	14581	98.00	120.00	13.00	—	I5B.	15009	98.43	144.50	19.05	—	I5B.
23396	95.25	130.00	13.49	—	I5BA	12076	98.00	124.00	15.00	—	I5B.	19012	98.43	152.40	14.29	—	I80
23398	95.25	130.18	13.49	—	I5BB	11357	98.00	125.00	12.00	—	I5BB	23430	98.47	127.00	11.91	—	I5BA
23397	95.25	130.18	13.49	—	I5B.	23413	98.00	125.00	12.00	—	I5B.	11535	98.50	143.00	20.60	—	I5BB
12429	95.25	130.20	11.90	—	I5BB	23414	98.00	125.00	12.00	—	I2BB	12524	100.00	112.00	7.00	—	I5BB
12429	95.25	130.20	11.90	—	I5BB	11357	98.00	125.00	12.00	—	I5BB	15501	100.00	114.30	14.29	—	I5B.
12429	95.25	130.20	11.90	—	I5C	23415	98.00	125.00	13.00	—	I5B.	23431	100.00	115.00	9.00	—	I5BA
12430	95.25	130.20	15.87	—	I5BB	11343	98.00	127.00	11.00	—	I5B.	14582	100.00	115.00	10.00	—	I5BB
12430	95.25	130.20	15.87	—	I5B.	20400	98.00	127.00	13.00	—	I5JL	14582	100.00	115.00	10.00	—	I5BA
15523	95.25	133.40	9.52	—	F	11732	98.00	127.00	13.00	—	I5BA	23432	100.00	115.00	10.00	—	I2BB
15840	95.25	133.40	14.29	—	I5BB	11539	98.00	128.00	10.00	—	I5BB	17902	100.00	117.50	14.29	—	F
15840	95.25	133.40	14.29	—	I5B.	23416	98.00	128.00	10.00	—	I5B.	23433	100.00	120.00	8.00	—	I5B.
20262	95.25	133.50	11.88	—	I2B.	23417	98.00	128.00	10.00	—	I2B.	23433	100.00	120.00	8.00	—	I5BB
15661	95.25	136.50	12.70	—	F	23418	98.00	130.00	13.00	—	I5B.	13579	100.00	120.00	10.00	—	I2BB
19120	95.25	136.50	12.70	—	I5B.	16828	98.00	135.00	14.00	—	I5B.	11187	100.00	120.00	10.00	—	I5BB
11311	95.25	136.50	14.29	—	I5B.	15082	98.43	114.30	6.35	—	I4B.	11187	100.00	120.00	10.00	—	I5BB
16579	95.25	139.70	12.70	—	I5B.	17903	98.43	114.30	11.11	—	I5B.	23434	100.00	120.00	10.00	—	I5BA
19121	95.25	139.70	14.29	—	I5B.	23419	98.43	120.65	11.11	—	I2B.	13579	100.00	120.00	10.00	—	I2BB
17982	95.25	139.70	23.80	—	ESPE	23420	98.43	120.65	11.91	—	I5B.	14583	100.00	120.00	11.00	—	I5BB
15844	95.25	146.10	11.10	—	I5B.	17198	98.43	120.70	14.29	—	I5B.	14583	100.00	120.00	11.00	—	I5BB
15844	95.25	146.10	11.10	—	I5C	15662	98.43	120.70	19.05	—	F	14583	100.00	120.00	11.00	—	I5B.



# Retentores

Perfis - Ver Última Página



INCOVE VEDAÇÕES LTDA.

Cod.	Di	De	Ha1	Ha2	Mod	Cod.	Di	De	Ha1	Ha2	Mod	Cod.	Di	De	Ha1	Ha2	Mod
11475	100.00	120.00	12.00	—	I5TG	19128	100.00	130.00	13.00	—	I5BB	20282	101.00	124.00	13.00	—	I5B.
13580	100.00	120.00	12.00	—	I2BB	19128	100.00	130.00	13.00	—	I5BB	23468	101.00	127.00	8.20	—	I5BB
11475	100.00	120.00	12.00	—	I5BA	23445	100.00	130.00	13.00	—	I5BA	23469	101.60	119.06	11.11	—	I5BB
13580	100.00	120.00	12.00	—	I2BB	19128	100.00	130.00	13.00	—	I5B.	13691	101.60	119.10	11.10	—	I5JM
11475	100.00	120.00	12.00	—	I5BB	23446	100.00	130.00	13.00	—	I2BA	19003	101.60	120.70	14.29	—	I5B.
11953	100.00	120.00	13.00	—	I5B.	12585	100.00	130.00	13.00	—	I2B	16264	101.60	120.80	7.92	—	I4BA
11953	100.00	120.00	13.00	—	I2B.	19128	100.00	130.00	13.00	—	I5BB	17621	101.60	123.80	6.35	—	I4B.
14774	100.00	120.00	13.00	—	I5BB	23447	100.00	130.00	15.00	—	I5BA	17269	101.60	123.80	7.94	—	F
14774	100.00	120.00	13.00	—	I5B.	23448	100.00	130.00	15.00	—	I2BA	16249	101.60	123.80	9.50	—	I5BB
11944	100.00	120.00	13.00	—	I5B.	16764	100.00	130.00	15.00	—	I5B.	15570	101.60	123.80	15.87	—	I5B.
11705	100.00	120.00	13.00	—	I2BB	11574	100.00	130.00	16.00	—	I5JM	15570	101.60	123.80	15.87	—	I5C
16497	100.00	120.00	13.00	—	I7BB	11860	100.00	130.17	15.87	—	I5JM	23470	101.60	123.83	15.88	—	I2BA
12028	100.00	120.00	14.00	—	I5B	17713	100.00	130.20	15.87	—	I5JM	18738	101.60	127.00	6.35	—	I4BA
23436	100.00	120.00	15.00	—	I5B.	14060	100.00	131.80	12.70	—	I2L	14692	101.60	127.00	7.90	—	I5BB
14012	100.00	122.20	33.34	—	ESPE	14060	100.00	131.80	12.70	—	I5JM	14692	101.60	127.00	7.94	—	I5BB
22520	100.00	123.00	10.00	—	I5B.	11176	100.00	132.00	12.50	—	I5BB	14692	101.60	127.00	7.94	—	I5B.
23437	100.00	123.00	10.00	—	I5B.	11176	100.00	132.00	12.50	—	I5B.	13803	101.60	127.00	7.94	—	I2BA
18223	100.00	123.80	12.70	—	F	23449	100.00	133.00	17.00	—	I5BB	23471	101.60	127.00	8.33	—	I5BA
13636	100.00	123.80	13.00	—	I5B	17835	100.00	133.40	11.90	—	I5B.	14011	101.60	127.00	9.50	—	I2BA
13636	100.00	123.80	13.00	—	I5BA	11207	100.00	133.40	12.70	—	I5BB	14011	101.60	127.00	9.52	—	I2BA
13636	100.00	123.80	13.00	—	I5B.	16650	100.00	133.40	12.70	—	I5BA	23472	101.60	127.00	9.53	—	I5B.
17889	100.00	123.80	15.87	—	I5B.	23450	100.00	135.00	9.00	—	I2BA	12242	101.60	127.00	11.00	—	I5BA
12821	100.00	125.00	8.00	—	I4BB	12390	100.00	135.00	12.00	—	I4JM	12242	101.60	127.00	11.11	—	I5BB
14585	100.00	125.00	12.00	—	I5BB	23451	100.00	135.00	15.00	—	I5B.	23473	101.60	127.00	11.11	—	I5BA
14585	100.00	125.00	12.00	—	I5BB	16586	100.00	135.00	15.80	—	I2BA	12242	101.60	127.00	11.11	—	I5B.
14585	100.00	125.00	12.00	—	I5BA	23452	100.00	135.00	16.00	—	I2BA	23474	101.60	127.00	11.11	—	I5C
14585	100.00	125.00	12.00	—	I5B.	14900	100.00	136.50	6.35	—	I4C	12242	101.60	127.00	11.11	—	I5B.
11204	100.00	125.00	12.00	—	I2BB	17697	100.00	136.50	12.70	—	I5B.	12242	101.60	127.00	11.20	—	I5BA
14585	100.00	125.00	12.00	—	I5BB	17697	100.00	136.50	12.70	—	I5C	12252	101.60	127.00	11.90	—	I2B
13690	100.00	125.00	13.00	—	I5JM	15008	100.00	136.50	26.99	—	ESPE	12252	101.60	127.00	11.90	—	I2B.
12431	100.00	125.00	13.00	—	I5BB	15008	100.00	136.50	26.99	—	ESPE	12252	101.60	127.00	11.90	—	I2B.
23439	100.00	125.00	13.00	—	I5BA	19002	100.00	139.70	14.29	—	I5B.	23475	101.60	127.00	11.91	—	I2BB
11215	100.00	125.00	13.00	—	I2BB	18737	100.00	139.70	23.81	—	I7C	20326	101.60	127.00	12.70	—	I5JL
23438	100.00	125.00	13.00	—	I2BA	14586	100.00	140.00	13.00	—	I5BA	16406	101.60	127.00	12.70	—	I5B.
16982	100.00	125.00	13.30	—	I5T	14586	100.00	140.00	13.00	—	I5B.	17000	101.60	127.00	12.70	—	I5B.
14585	100.00	125.00	14.00	—	I5C	14587	100.00	142.00	15.00	—	I5BB	17000	101.60	127.00	12.70	—	I5BB
16083	100.00	125.00	15.00	—	I5BB	14587	100.00	142.00	15.00	—	I5BB	17000	101.60	127.00	12.70	—	I5BB
16083	100.00	125.00	15.00	—	I5B.	14674	100.00	150.00	10.00	—	I5BB	17000	101.60	127.00	12.70	—	I5JM
23440	100.00	125.00	15.00	—	I2B.	23453	100.00	150.00	12.00	—	I5BB	13722	101.60	127.00	12.70	—	I5JM
16484	100.00	125.00	15.00	—	I7BB	23454	100.00	150.00	13.00	—	I2BB	16556	101.60	127.00	12.70	—	I2BB
16083	100.00	125.00	15.00	—	I5B.	16633	100.00	150.00	13.00	—	I2BB	13310	101.60	127.00	12.70	—	ESPE
15137	100.00	125.40	9.52	—	F	11751	100.00	150.00	13.00	—	I2JM	16595	101.60	127.00	12.70	—	I2B.
16903	100.00	126.00	11.00	—	I5BB	18151	100.00	158.80	14.29	—	I800	16595	101.60	127.00	12.70	—	I2B.
16903	100.00	126.00	11.00	—	I5BB	23455	100.00	160.00	15.00	—	I5BB	13310	101.60	127.00	12.70	—	I2BB
23441	100.00	126.00	11.00	—	I5B.	14674	100.00	160.25	10.00	—	I5BB	16595	101.60	127.00	12.70	—	I2B.
13806	100.00	127.00	7.00	—	I5C	14588	100.00	162.00	15.00	—	I5BB	17000	101.60	127.00	12.70	—	I5C
17329	100.00	127.00	9.52	—	F	14588	100.00	162.00	15.00	—	I5BB	17487	101.60	127.00	15.08	—	I3B.
16599	100.00	127.00	11.00	—	I5B.	14589	100.00	165.00	13.00	—	I5B.	15128	101.60	127.00	15.87	—	F
15636	100.00	127.00	11.90	—	I5BB	14590	100.00	182.00	15.00	—	I5BB	EM ES	101.60	127.00	15.87	—	I2
15636	100.00	127.00	11.90	—	I5B.	23456	100.00	182.00	15.00	—	I5BB	.....	101.60	127.00	16.00	—	ESPE
15636	100.00	127.00	11.90	—	I5B.	23457	100.01	114.30	14.29	—	I5BB	13403	101.60	127.00	17.46	—	I2B
18736	100.00	127.00	15.08	—	I2B.	23458	100.01	123.83	12.70	—	I5B.	13403	101.60	127.00	17.46	—	I2B.
23442	100.00	128.00	8.00	—	I5B.	23459	100.01	123.83	15.88	—	I5B.	13403	101.60	127.00	17.46	—	ESPE
13170	100.00	128.00	15.00	25.00	ESPE	23460	100.01	125.41	12.70	—	I5B.	23476	101.60	127.00	17.86	—	I2B.
13170	100.00	128.00	15.00	25.00	ESPE	23461	100.01	127.00	12.70	—	I5B.	18739	101.60	127.00	22.22	—	I9B.
16414	100.00	130.00	10.00	—	I5F	22518	100.01	127.00	12.70	—	I2B.	12242	101.60	127.10	11.10	—	I5B.
11394	100.00	130.00	10.00	—	I5BB	23462	100.01	127.00	15.88	—	I5B.	14011	101.60	127.12	9.52	—	I2BA
12432	100.00	130.00	12.00	—	I5BB	23463	100.01	133.35	15.88	—	I5B.	12481	101.60	128.60	9.92	—	I5JM
12432	100.00	130.00	12.00	—	I5C	23464	100.01	133.85	11.91	—	I5B.	23477	101.60	130.18	14.29	—	I5B.
12432	100.00	130.00	12.00	—	I5BB	23465	100.01	136.53	12.70	—	I2B.	23478	101.60	130.18	15.88	—	I2BB
12432	100.00	130.00	12.00	—	I2BB	23466	100.01	142.88	12.70	—	I5B.	17380	101.60	130.20	12.70	—	I5BB
12432	100.00	130.00	12.00	—	I5BB	23467	100.01	200.25	9.53	—	I5BA	13390	101.60	130.20	12.70	—	I5BB
20018	100.00	130.00	12.00	—	I5JM	12496	100.30	127.00	7.70	—	I5BA	11126	101.60	130.20	13.49	—	I5B.
23444	100.00	130.00	12.00	—	I2B	16503	100.50	120.50	12.00	—	I5B.	17380	101.60	130.20	14.30	—	I5B.
12854	100.00	130.00	12.00	—	I2BB	13004	100.60	115.90	9.52	—	I5BA	17380	101.60	130.20	14.30	—	I5BB
12585	100.00	130.00	13.00	—	I2BB	17889	100.80	123.80	15.87	—	I5B.	17391	101.60	130.20	15.08	—	I2B.
19128	100.00	130.00	13.00	—	I5BA	20230	101.00	114.00	8.00	12.00	RASP	23479	101.60	133.35	9.53	—	I5B.





Cod.	Di	De	Ha1	Ha2	Mod	Cod.	Di	De	Ha1	Ha2	Mod	Cod.	Di	De	Ha1	Ha2	Mod
23480	101.60	133.35	11.91	---	I2BA	13791	103.20	133.40	17.46	---	I4BB	15497	104.80	146.10	14.28	---	I5B.
23481	101.60	133.35	12.70	---	I2B.	19133	103.20	136.50	12.70	---	I5B.	15497	104.80	146.10	14.28	---	I5BB
17040	101.60	133.35	12.70	---	I5BB	15816	103.20	139.70	14.28	---	I5B.	15497	104.80	146.10	14.28	---	I4BB
23482	101.60	133.35	15.88	---	I5B.	15816	103.20	139.70	14.28	---	I5B.	18755	104.80	146.10	18.25	---	I3
12819	101.60	133.40	11.11	---	I5B.	19134	103.20	142.90	12.70	---	I5B.	19139	104.80	149.20	12.70	---	I5B.
12819	101.60	133.40	11.11	---	I5BA	18743	103.20	146.10	14.28	---	I5B.	18305	104.80	152.40	15.00	---	I5C
17040	101.60	133.40	12.70	---	I5BA	19135	103.20	149.20	12.70	---	I5B.	18305	104.80	152.40	15.87	---	I5B.
17040	101.60	133.40	12.70	---	I5B.	18744	103.20	152.40	15.87	---	I5B.	19140	104.80	155.60	12.70	---	I5B.
17040	101.60	133.40	12.70	---	I5C	19136	103.20	155.60	12.70	---	I5B.	18750	104.80	158.80	14.29	---	I5B.
12732	101.60	133.40	14.29	---	I5BA	15536	103.20	157.20	9.52	---	I13	19943	104.80	161.90	15.87	---	I5B.
12946	101.60	133.40	15.87	---	I5B.	18745	103.20	157.80	12.70	---	I80	23511	105.00	115.00	14.00	---	I5BA
15321	101.60	134.90	34.93	---	I5B.	18746	103.20	157.80	14.28	---	I5B.	23512	105.00	125.00	12.00	---	I5BA
20259	101.60	136.50	11.11	---	I5B.	16317	103.90	133.30	11.90	---	I5B.	12803	105.00	125.00	13.00	---	I5BB
15859	101.60	136.50	12.70	---	I5B.	23497	104.00	125.00	10.00	---	I5BB	12803	105.00	125.00	13.00	---	I5BA
15859	101.60	136.50	12.70	---	I5C	23498	104.00	130.00	13.00	---	I5B.	23513	105.00	125.00	13.00	---	I5B.
17845	101.60	136.50	19.05	---	ESPE	13683	104.00	135.00	13.00	---	I5B.	12803	105.00	125.00	13.00	---	I5BB
23483	101.60	136.53	15.88	---	I5B.	20395	104.00	139.00	8.00	---	I2BA	11239	105.00	130.00	7.50	---	I2BB
13120	101.60	139.70	14.29	---	I2B.	23520	104.00	180.00	15.00	---	I5B.	23514	105.00	130.00	8.00	---	I5BB
17196	101.60	139.70	14.29	---	I5B.	17240	104.77	133.35	11.90	---	I5BA	23516	105.00	130.00	12.00	---	I5BB
13120	101.60	139.70	14.29	---	I2B.	17240	104.77	133.35	11.90	---	I5B.	23515	105.00	130.00	12.00	---	I5BA
13120	101.60	139.70	14.29	---	I2C	23499	104.78	127.00	12.70	---	I2BA	23516	105.00	130.00	12.00	---	I2BB
17196	101.60	139.70	14.29	---	I5C	23500	104.78	127.00	14.29	---	I2B.	14592	105.00	130.00	13.00	---	I5BA
17696	101.60	139.70	18.26	---	I2C	23501	104.78	130.18	12.70	---	I5B.	14592	105.00	130.00	13.00	---	I5BB
17615	101.60	139.70	23.81	---	L1	23502	104.78	130.18	15.88	---	I5B.	14592	105.00	130.00	13.00	---	I5BA
23484	101.60	139.70	23.81	---	I5B.	23503	104.78	133.35	12.70	---	I5BB	23517	105.00	130.00	13.00	---	I5B.
23485	101.60	142.88	12.70	---	I5B.	23504	104.78	133.35	12.70	---	I2BB	12433	105.00	130.00	13.00	---	I2BB
15195	101.60	142.90	12.70	---	I5B.	23505	104.78	133.35	15.88	---	I2BB	12433	105.00	130.00	13.00	---	I2B.
15195	101.60	142.90	12.70	---	I5C	23506	104.78	136.53	11.91	---	I5BA	12433	105.00	130.00	13.00	---	I2BA
22467	101.60	143.02	9.52	---	I2BA	23507	104.78	142.88	12.70	---	I5BB	14592	105.00	130.00	13.00	---	I5BB
23486	101.60	146.05	12.70	---	I5B.	23508	104.78	146.05	14.29	---	I5BB	13090	105.00	130.00	13.11	---	I2B
23487	101.60	146.05	14.29	---	I5B.	14584	104.80	123.80	11.11	---	I4	23518	105.00	130.00	15.00	---	I5B.
15402	101.60	146.10	14.29	---	I5C	17997	104.80	127.00	7.90	---	I4BB	12534	105.00	130.00	16.00	---	I2B.
15402	101.60	146.10	14.29	---	I5B.	17997	104.80	127.00	7.93	---	I4BB	16634	105.00	130.00	18.00	---	I5BB
18740	101.60	146.10	20.64	---	I1FB	17997	104.80	127.00	7.93	---	I5C	13223	105.00	130.00	18.00	---	I5BB
15194	101.60	146.10	22.22	---	ESPE	11053	104.80	127.00	11.11	---	I5BB	.....	105.00	135.00	12.00	---	ESPE
15194	101.60	146.10	22.22	---	I5B.	19934	104.80	127.00	11.11	---	I5JM	14593	105.00	135.00	13.00	---	I5B.
19130	101.60	149.20	12.70	---	I5B.	17494	104.80	127.00	11.90	---	I5B.	14593	105.00	135.00	13.00	---	I5C
12570	101.60	152.40	12.70	---	I5F	17494	104.80	127.00	11.90	---	I5C	14593	105.00	135.00	14.00	---	I5BA
18741	101.60	152.40	15.87	---	I5B.	13405	104.80	127.00	12.70	---	I2B.	13247	105.00	135.00	15.00	---	I2BB
23488	101.60	155.88	12.70	---	I5B.	13405	104.80	127.00	12.70	---	I2BA	13247	105.00	135.00	15.00	---	I2BB
23489	101.60	158.75	14.29	---	I5B.	18038	104.80	127.00	14.28	---	I2B.	13247	105.00	135.00	15.00	---	I2BB
15819	101.60	158.80	14.29	---	I5B.	18301	104.80	127.00	15.87	---	I13	13247	105.00	135.00	15.00	---	I2BB
17688	101.60	161.90	14.29	---	I5B.	16434	104.80	127.10	12.00	---	I5C	23519	105.00	135.00	15.00	---	I2BB
14069	101.60	165.10	34.93	---	ESPE	18747	104.80	130.20	15.87	---	I5B.	13247	105.00	135.00	15.00	---	I2BB
17257	101.60	212.70	15.87	---	I5B.	18747	104.80	130.20	15.87	---	I2BB	16196	105.00	135.00	15.00	---	I2BB
11650	102.00	115.00	10.00	---	I5BB	17240	104.80	133.40	11.90	---	I5B.	14752	105.00	135.00	16.00	---	I7BB
13534	102.00	122.00	13.00	---	I5B.	11458	104.80	133.40	11.90	---	I2BB	14752	105.00	135.00	16.00	---	I7B.
14836	102.00	125.00	13.00	---	I5BB	11500	104.80	133.40	15.87	---	I5BB	11379	105.00	136.75	12.70	---	I5JM
23490	102.00	125.00	13.00	---	I5B.	13625	104.80	133.40	23.81	---	I1FC	12522	105.00	140.00	12.00	---	I5BB
16985	102.00	125.00	---	---	I4B.	13625	104.80	133.40	23.81	---	I1	12522	105.00	140.00	12.00	---	I5BB
13390	102.00	130.00	13.00	---	I5BB	18748	104.80	133.40	24.61	---	I7B.	23521	105.00	140.00	12.00	---	I5BA
13390	102.00	130.00	13.00	---	I5BB	14752	104.80	134.90	15.87	---	I7BB	23523	105.00	140.00	13.00	---	I5BA
23491	102.00	130.00	13.00	---	I5B.	19137	104.80	136.50	12.70	---	I5JM	12882	105.00	140.00	14.00	---	I5BB
16805	102.00	140.00	6.80	---	I5BB	19137	104.80	136.50	12.70	---	I5B.	12882	105.00	140.00	14.00	---	I5BB
14591	102.00	180.50	14.00	---	I5B.	19137	104.80	136.50	12.70	---	I5C	23524	105.00	140.00	15.00	---	I5B.
23492	102.39	127.00	12.00	---	I5BA	15981	104.80	136.50	17.46	---	ESPE	13670	105.00	140.00	17.00	---	I5BA
23493	102.39	130.18	12.70	---	I5B.	15862	104.80	139.70	11.11	---	I813	23525	105.00	145.00	14.00	---	I5B.
23494	103.00	125.00	13.00	---	I5B.	13015	104.80	139.70	14.28	---	I7B.	23526	105.00	145.00	15.00	---	I5BA
23495	103.00	128.00	13.00	---	I2BB	18749	104.80	139.70	14.28	---	I5B.	20016	105.00	145.00	16.00	---	I5B.
16664	103.00	133.50	16.50	---	I5BB	13015	104.80	139.70	14.28	---	I7BA	14594	105.00	145.00	16.00	---	I7
23496	103.00	140.00	10.00	---	I5B.	19947	104.80	139.70	19.05	---	I120	14594	105.00	145.00	16.00	---	I5C
13729	103.00	155.00	10.00	---	I5B.	19985	104.80	142.90	4.76	---	I4B.	23527	105.00	150.00	15.00	---	I5B.
13753	103.20	127.00	22.22	---	I2B.	19985	104.80	142.90	4.76	---	I4B.	13930	105.00	152.00	15.00	---	I5BB
19132	103.20	130.20	12.70	---	I5B.	19138	104.80	142.90	12.70	---	I5BA	13930	105.00	152.00	15.00	---	I5B.
12810	103.20	130.20	12.70	---	I2BA	19138	104.80	142.90	12.70	---	I5BA	19943	105.00	162.00	15.00	---	I5B.
12810	103.20	130.20	12.70	---	I2B.	14779	104.80	142.90	20.63	---	ESPE	19943	105.00	162.00	15.00	---	I5C
18742	103.20	133.40	11.90	---	I5B.	17315	104.80	146.10	11.11	---	I13	25469	105.70	130.20	9.00	---	I5BB



# Retentores

Perfis - Ver Última Página



INCOVE VEDAÇÕES LTDA.

Cod.	Di	De	Ha1	Ha2	Mod	Cod.	Di	De	Ha1	Ha2	Mod	Cod.	Di	De	Ha1	Ha2	Mod
13730	106.00	150.00	12.00	—	I5B.	23561	107.95	153.99	14.29	—	I5B.	18758	109.50	139.70	14.29	—	I5BA
23528	106.36	127.00	11.91	—	I5BB	23562	107.95	155.58	15.88	—	I5B.	18758	109.50	139.70	14.29	—	I5BB
23529	106.36	133.35	9.53	—	I2BA	23563	107.95	165.10	15.88	—	I5B.	11459	109.50	139.70	14.29	—	I2BB
23530	106.36	133.35	11.91	—	I5BA	23564	107.95	169.86	12.70	—	I5BB	15500	109.50	141.30	12.70	—	I13
23531	106.36	139.70	14.29	—	I2BB	23565	107.95	180.98	15.88	—	I5B.	19147	109.50	142.90	12.70	—	I5B.
23532	106.36	142.88	12.70	—	I5B.	12593	108.00	123.80	7.94	9.52	ESPE	20017	109.50	143.00	14.00	—	I5B.
23534	106.36	146.05	14.29	—	I5BB	11826	108.00	125.00	13.50	—	I5BB	18759	109.50	146.10	14.29	—	I5B.
23535	106.36	152.40	15.88	—	I5B.	15961	108.00	127.00	12.70	—	I5C	18759	109.50	146.10	14.29	—	I5B.
15863	106.40	125.40	12.70	—	I5B.	20132	108.00	128.00	9.00	—	I2BB	18760	109.50	150.00	14.29	—	I5B.
17610	106.40	127.00	11.90	—	I5B.	23566	108.00	130.00	12.00	—	I5BB	19149	109.50	155.60	12.70	—	I5B.
13411	106.40	127.00	11.90	—	I2BA	11652	108.00	130.00	13.00	—	I5BB	19897	109.50	161.90	14.29	—	I5B.
13411	106.40	127.00	11.90	—	I2B.	23567	108.00	130.00	13.00	—	I5B.	19898	109.50	169.90	12.70	—	I5B.
17610	106.40	127.00	11.90	—	I5B.	17980	108.00	130.20	7.94	—	I5JM	23570	109.54	133.75	12.30	—	I5B.
19979	106.40	130.20	6.35	—	I4B.	16773	108.00	133.30	12.70	—	ESPE	23571	109.54	136.53	19.05	—	I2B.
18751	106.40	133.40	11.90	—	I5B.	—	108.00	133.35	12.00	—	I2B.	23572	109.54	139.70	14.29	—	I5BA
19141	106.40	136.50	12.70	—	I5B.	19004	108.00	133.40	6.35	—	I4B.	23573	109.54	139.70	14.29	—	I5B.
19141	106.40	136.50	12.70	—	I5C	13016	108.00	133.40	9.52	—	I5B.	23574	109.54	139.71	12.70	—	I2BB
18752	106.40	139.70	14.29	—	I5C	13016	108.00	133.40	9.52	—	I5B.	23575	109.54	146.05	14.29	—	I2BA
19142	106.40	142.80	14.29	—	I5BA	17187	108.00	133.40	11.90	—	I5B.	23576	109.54	150.40	15.88	—	I5B.
17609	106.40	146.10	14.29	—	I5B.	20068	108.00	133.40	12.70	—	I5JM	23577	109.54	152.40	15.88	—	I2BA
19143	106.40	149.20	12.70	—	I5B.	16773	108.00	133.40	12.70	—	I2B.	23578	109.54	158.75	14.29	—	I5B.
18753	106.40	152.40	15.87	—	I5C	13372	108.00	133.40	14.30	—	I5BB	12332	109.70	140.00	12.00	40.00	ESPE
19144	106.40	155.60	12.70	—	I5B.	13371	108.00	133.40	15.88	—	I5B.	14596	110.00	120.00	12.00	—	I5B.
15818	106.40	158.80	14.29	—	I5C	17033	108.00	133.40	19.05	—	I1FC	16375	110.00	120.00	13.00	—	I5BA
17858	106.40	161.90	15.87	—	I5B.	12589	108.00	133.50	15.00	—	I5B.	23580	110.00	125.00	7.00	—	I5BB
17858	106.40	161.90	15.87	—	I5C	15962	108.00	136.50	12.70	—	I5B.	16696	110.00	125.00	12.00	—	I5BB
18154	106.40	165.10	19.05	—	D8F	15962	108.00	136.50	12.70	—	I5B.	11781	110.00	125.00	15.00	—	I5BB
14595	107.00	130.00	13.00	—	I5B.	18124	108.00	138.10	17.46	—	I5B.	16316	110.00	126.00	13.00	—	I5BA
23536	107.00	130.00	13.00	—	I2BB	12434	108.00	139.70	12.70	—	I5JM	16316	110.00	126.00	13.00	—	I5BA
23537	107.00	133.60	10.00	—	I2BA	12434	108.00	139.70	12.70	—	I5BB	23582	110.00	128.00	9.00	—	I5BA
23538	107.00	140.00	13.00	—	I5B.	11285	108.00	139.70	13.00	—	I5BA	23581	110.00	128.00	9.00	—	I5B.
17187	107.20	133.40	11.90	—	I5BB	11285	108.00	139.70	13.00	—	I5B.	16499	110.00	128.00	19.00	—	I5B.
17187	107.20	133.40	11.90	—	I5B.	12829	108.00	139.70	14.29	—	I5B.	23583	110.00	130.00	9.00	—	I5BA
17187	107.20	133.40	11.90	—	I5C	17489	108.00	139.70	14.29	—	I5B.	12202	110.00	130.00	12.00	—	I5BB
17187	107.20	133.40	12.70	—	I5BA	17489	108.00	139.70	14.29	—	I5C	12202	110.00	130.00	12.00	—	I5BB
18754	107.20	152.40	15.87	—	I5B.	19908	108.00	139.70	17.46	—	I2B.	12202	110.00	130.00	12.00	—	I5BA
18754	107.20	152.40	15.87	—	I5C	12435	108.00	139.70	19.00	—	I12B	12202	110.00	130.00	12.00	—	I5BA
17489	107.85	139.70	14.29	—	I5B.	17616	108.00	139.70	23.81	—	I1FB	12347	110.00	130.00	13.00	—	I2BA
23540	107.95	127.00	11.11	—	I5B.	23568	108.00	140.00	12.00	—	I5B.	12347	110.00	130.00	13.00	—	I2BA
23541	107.95	127.00	12.70	—	I5B.	23569	108.00	140.00	13.00	—	I5B.	12347	110.00	130.00	13.00	—	I2BB
23509	107.95	133.35	9.53	—	I5B.	17489	108.00	140.00	14.00	—	I5B.	14597	110.00	130.00	13.00	—	I5BA
23542	107.95	133.35	11.11	—	I5B.	17489	108.00	140.00	14.00	—	I5C	12347	110.00	130.00	13.00	—	I2BB
23543	107.95	133.35	11.11	—	I2BB	15906	108.00	142.90	12.70	—	I5B.	14597	110.00	130.00	13.00	—	I5BB
23544	107.95	133.35	11.91	—	I5BB	12638	108.00	144.50	190.05	—	I5B.	23584	110.00	130.00	13.00	—	I5BA
23547	107.95	133.35	12.70	—	I5BA	17048	108.00	146.10	14.29	—	I5B.	14597	110.00	130.00	13.00	—	I5B.
23545	107.95	133.35	12.70	—	I5B.	17848	108.00	146.10	28.58	—	I	12347	110.00	130.00	13.00	—	I2B.
23546	107.95	133.35	12.70	—	I2BB	19145	108.00	149.20	12.70	—	I5B.	14597	110.00	130.00	13.00	—	I5BB
23548	107.95	133.35	14.29	—	I5BB	18756	108.00	150.00	14.29	—	I5B.	14597	110.00	130.00	13.00	—	I5BB
23549	107.95	133.35	15.88	—	I5B.	15207	108.00	150.80	15.88	—	I5B.	12347	110.00	130.00	13.00	—	I5BA
16596	107.95	133.38	11.13	—	I5B.	20402	108.00	152.40	14.00	—	I5BA	12347	110.00	130.00	13.00	—	I2BA
11427	107.95	133.38	11.13	—	I2BB	17786	108.00	152.40	15.88	—	I8B.	11521	110.00	130.00	15.00	—	I5B.
11427	107.95	133.38	11.13	—	I2BA	19912	108.00	154.00	142.90	—	I5B.	20370	110.00	130.00	18.00	—	I5BA
11427	107.95	133.38	11.13	—	I2B.	20261	108.00	155.60	14.29	—	I2	22575	110.00	132.00	11.00	—	I5JL
23550	107.95	136.53	12.70	—	I5BB	17385	108.00	155.60	15.88	—	I5C	11988	110.00	135.00	10.00	—	I5B.
23551	107.95	136.53	15.88	—	I5B.	15253	108.00	158.80	15.88	—	I5C	25457	110.00	135.00	11.11	—	I5BB
16593	107.95	139.70	11.11	—	I5B.	15406	108.00	161.90	19.05	—	I1FB	11229	110.00	135.00	12.00	—	I5BB
12434	107.95	139.70	12.70	—	JM	15491	108.00	165.40	15.88	—	I5B.	23585	110.00	135.00	12.00	—	I5B.
12434	107.95	139.70	12.70	—	I5BB	18757	108.00	181.00	15.88	—	I5B.	20205	110.00	138.00	10.00	—	I5B.
23552	107.95	139.70	13.10	—	I5B.	11319	108.36	140.00	14.54	—	I5B.	16520	110.00	139.40	13.00	—	I5BB
23553	107.95	139.70	14.29	—	I5B.	15961	109.00	127.00	12.70	—	I5B.	13780	110.00	139.50	14.50	—	I5JL
23554	107.95	139.70	15.88	—	I5B.	20305	109.00	140.00	13.50	—	I9B.	11136	110.00	140.00	12.00	—	I5BB
23555	107.95	139.70	19.05	—	I5B.	11153	109.00	150.40	12.70	—	I5BB	23586	110.00	140.00	12.00	—	I5BA
23556	107.95	144.46	19.05	—	I5B.	18761	109.00	152.40	15.88	—	I5B.	11173	110.00	140.00	12.00	—	I2BB
23557	107.95	146.05	14.29	—	I5B.	17531	109.00	158.80	14.29	—	I5B.	11173	110.00	140.00	12.00	—	I2BB
23558	107.95	149.23	12.70	—	I5B.	19896	109.50	133.40	12.00	—	I5B.	—	110.00	140.00	12.50	—	I2BB
23559	107.95	149.23	15.88	—	I2B.	19146	109.50	136.50	12.70	—	I5B.	12436	110.00	140.00	13.00	—	I5B.
23560	107.95	150.05	14.29	—	I5B.	17586	109.50	139.70	9.53	—	I13	12436	110.00	140.00	13.00	—	I2B.





# Retentores

Perfis - Ver Última Página



INCOVE VEDAÇÕES LTDA.

Cod.	Di	De	Ha1	Ha2	Mod	Cod.	Di	De	Ha1	Ha2	Mod	Cod.	Di	De	Ha1	Ha2	Mod
12436	110.00	140.00	13.00	—	I2BA	17376	111.10	161.90	57.15	—	SANF	11152	114.30	136.50	14.29	—	I5BB
13197	110.00	140.00	13.00	—	I2B.	12967	111.10	183.30	12.50	—	I5B.	23620	114.30	136.53	9.53	—	I2BB
13197	110.00	140.00	13.00	—	I2B.	15081	111.12	139.70	14.29	—	I5B.	16968	114.30	136.53	11.11	—	I5BB
12436	110.00	140.00	13.00	—	I5BB	23599	111.13	133.35	12.70	—	I2BA	11823	114.30	139.50	12.70	—	I5B.
12436	110.00	140.00	13.00	—	I5B	23600	111.13	139.70	14.29	—	I2BB	15227	114.30	139.65	14.30	—	I5B.
12436	110.00	140.00	13.00	—	I5B	23601	111.13	139.70	15.88	—	I5B.	14043	114.30	139.70	9.53	—	I8B.
12436	110.00	140.00	13.00	—	I2B.	23602	111.13	142.88	12.70	—	I5BB	12392	114.30	139.70	9.53	—	I2BA
13197	110.00	140.00	13.00	—	I2B.	23603	111.13	146.05	14.29	—	I5B.	12392	114.30	139.70	9.53	—	I2BA
12436	110.00	140.00	13.00	—	I5BB	23604	111.13	149.23	14.29	—	I5B.	19041	114.30	139.70	11.11	—	I5JM
12436	110.00	140.00	13.00	—	I5BB	23605	111.13	155.58	15.88	—	I5B.	23621	114.30	139.70	11.11	—	I5B.
12436	110.00	140.00	13.00	—	I5B.	23606	111.13	158.75	14.29	—	I5BB	11823	114.30	139.70	12.70	—	I5JL
16010	110.00	140.00	13.00	—	I2JM	19985	111.30	142.90	4.76	—	ESPE	23622	114.30	139.70	12.70	—	I5B.
20306	110.00	140.00	13.50	—	I5BA	14021	111.30	174.50	4.00	—	ESPE	11452	114.30	139.70	12.70	—	I2BB
23589	110.00	140.00	14.00	—	I2BA	11050	112.00	130.00	10.00	—	I5BB	15227	114.30	139.70	14.29	—	I5BB
16552	110.00	140.00	14.00	—	I5BA	23607	112.00	130.00	12.00	—	I5BA	15227	114.30	139.70	14.29	—	I5JL
23588	110.00	140.00	14.00	—	I5B.	14601	112.00	140.00	13.00	—	I5BB	15227	114.30	139.70	14.29	—	I5B.
23589	110.00	140.00	14.00	—	I2BB	23608	112.00	140.00	13.00	—	I5B.	23623	114.30	139.70	14.29	—	I2B.
12993	110.00	140.00	14.00	—	I5BB	23609	112.00	140.00	13.00	—	I2BA	.....	114.30	139.70	14.29	—	I5C
14598	110.00	140.00	14.00	—	I8BB	12694	112.00	140.00	13.00	—	I7B.	15227	114.30	139.70	14.29	—	I5C
20294	110.00	140.00	15.00	—	I5BA	23610	112.00	150.00	12.00	—	I5BA	15227	114.30	139.70	14.29	—	I5BB
23590	110.00	140.00	15.00	—	I5B.	14602	112.00	150.00	12.00	—	I5B.	15227	114.30	139.70	14.29	—	I5B.
23591	110.00	140.00	16.00	—	I5B.	23612	112.00	150.00	15.00	—	I5B.	23624	114.30	139.70	15.88	—	I5B.
13108	110.00	140.00	16.00	—	I2BB	23611	112.00	150.00	15.00	—	I2B.	17842	114.30	139.70	15.88	—	I3BC
13108	110.00	140.00	16.00	—	I2BB	14603	112.00	152.00	13.00	—	I5B.	17844	114.30	139.70	15.88	—	ESPE
20369	110.00	140.00	18.00	—	I5BA	14604	112.00	160.00	15.00	—	I5B.	17842	114.30	139.70	15.88	—	I3B.
13197	110.00	140.30	13.00	—	I2BA	18105	112.70	133.40	15.88	—	I13	22513	114.30	139.85	14.29	—	I5B.
12526	110.00	145.00	14.00	—	I2BB	17044	112.70	139.70	14.29	—	I5BA	15240	114.30	142.90	15.88	—	I5B.
23592	110.00	145.00	15.00	—	I5BA	17044	112.70	139.70	14.29	—	I5B.	11058	114.30	146.05	11.11	—	I5B.
23593	110.00	145.00	15.00	—	I2BA	14601	112.70	140.00	13.00	—	I5BB	23625	114.30	146.05	12.70	—	I5B
12507	110.00	145.00	18.00	—	I5JM	14601	112.70	140.00	13.00	—	I5BB	11058	114.30	146.05	14.29	—	I5JL
11032	110.00	150.00	12.00	—	I5B.	19153	112.70	142.90	12.70	—	I5B.	17019	114.30	146.05	14.30	—	I5BA
11222	110.00	150.00	13.00	—	I5BB	14823	112.70	144.50	12.70	—	I5BB	11061	114.30	146.05	15.87	—	I2BB
23594	110.00	150.00	13.00	—	I5B.	17894	112.70	146.10	14.29	—	I5B.	14058	114.30	146.10	11.11	—	I5B.
11222	110.00	150.00	13.00	—	I5BB	19154	112.70	149.20	12.70	—	I5B.	11737	114.30	146.10	14.29	—	I5JM
14599	110.00	150.00	15.00	—	I5B.	18765	112.70	152.40	15.88	—	I5B.	17019	114.30	146.10	14.29	—	I5B.
23595	110.00	152.00	15.00	—	I5B.	19155	112.70	155.60	12.70	—	I5B.	17019	114.30	146.10	14.29	—	I5C
14600	110.00	160.00	12.00	—	I5BB	18766	112.70	158.80	14.29	—	I5B.	18096	114.30	146.10	15.08	—	ESPE
14600	110.00	160.00	12.00	—	I5BB	17125	112.70	163.50	12.70	—	I13	11061	114.30	146.10	15.88	—	I5JL
13179	110.00	165.00	15.00	26.00	ESPE	18767	112.70	169.30	15.88	—	I5B.	14904	114.30	146.10	31.75	—	I5B.
14675	110.00	180.00	15.00	—	I5BB	23613	112.71	139.70	12.70	—	I5B.	18768	114.30	149.20	15.88	—	I5B.
14675	110.00	180.00	15.00	—	I5BB	23614	112.71	146.05	14.29	—	I5BB	12439	114.30	152.40	12.70	—	I5B.
19896	110.30	133.40	12.00	—	I2BA	17894	112.71	146.05	14.29	—	I5BA	23626	114.30	152.40	12.70	—	I5B.
19896	110.30	133.40	12.00	—	I5B.	23615	112.71	155.88	12.70	—	I5B.	16594	114.30	152.40	12.70	—	I2B.
18762	110.30	136.50	12.70	—	I5B.	23616	113.00	140.00	13.00	—	I5B.	12440	114.30	152.40	14.29	—	I5BB
18761	110.30	152.40	15.88	—	I5B.	11722	113.00	140.00	16.00	—	I5B.	23627	114.30	152.40	14.29	—	I5B.
23596	110.33	133.35	11.91	—	I5B.	13705	113.00	153.00	16.00	—	I5C	12440	114.30	152.40	14.29	—	I5C
23597	110.33	136.53	12.70	—	I5B.	13705	113.00	153.00	16.00	—	I5B.	12440	114.30	152.40	14.29	—	I5B.
23598	110.33	136.53	14.29	—	I5B.	22526	114.00	130.00	9.50	—	I2BA	17523	114.30	152.40	15.88	—	I5BB
11875	111.00	140.00	9.50	—	I2BA	20280	114.00	139.00	8.00	—	I5BB	17523	114.30	152.40	15.88	—	I5B.
19150	111.10	136.50	12.70	—	I5B.	20280	114.00	139.00	8.00	—	I5B.	12746	114.30	154.25	14.30	—	I13
13197	111.10	139.70	12.70	—	I2B.	22542	114.00	140.00	9.50	—	I2BA	14817	114.30	155.55	14.00	—	I2B.
17600	111.10	139.70	12.70	—	I8B.	22543	114.00	140.00	13.00	—	I5JM	23629	114.30	155.58	14.29	—	I5B.
11488	111.10	139.70	14.29	—	I2BB	12569	114.00	140.00	13.00	—	I5BA	23630	114.30	155.58	14.29	—	I2B.
15081	111.10	139.70	14.29	—	I5C	12508	114.00	145.00	18.00	—	I5JM	17006	114.30	155.60	14.29	—	I4B.
11670	111.10	139.70	15.88	—	I5BB	14021	114.00	174.40	16.00	—	ESPE	23631	114.30	158.75	11.11	—	I2B.
19151	111.10	142.90	12.70	—	I5B.	11522	114.30	127.00	9.52	—	I2BA	23632	114.30	158.75	14.29	—	I2B.
17499	111.10	146.40	14.29	—	I5B.	11432	114.30	127.00	12.70	—	I5BA	14783	114.30	158.80	11.11	—	I2
19152	111.10	149.20	12.70	—	I5JM	11723	114.30	130.20	7.94	—	I4B.	17350	114.30	158.80	14.29	—	I5B.
18763	111.10	152.40	15.88	—	I5B.	23619	114.30	133.35	11.11	—	I5B.	17350	114.30	158.80	14.29	—	I5C
18763	111.10	152.40	15.88	—	I5C	14031	114.30	133.35	12.70	—	I2BB	14817	114.30	159.60	14.29	—	I2B.
17850	111.10	154.00	12.70	—	I13	13481	114.30	133.40	11.11	—	I2BB	18769	114.30	161.90	15.88	—	I5B.
17847	111.10	154.00	15.88	—	I5B.	17899	114.30	133.40	12.70	—	I5BB	18770	114.30	181.00	15.88	—	I5B.
17847	111.10	154.00	15.88	—	I5C	17899	114.30	133.40	12.70	—	I5B.	14815	114.30	181.80	24.61	—	I5B.
18764	111.10	155.60	12.70	—	I5B.	17899	114.30	133.40	12.70	—	I5C	16676	114.50	139.50	14.50	—	I9BC
15549	111.10	158.80	14.29	—	I5BA	12438	114.30	133.70	15.88	—	I2B.	14605	115.00	130.00	13.00	—	I5BA
15549	111.10	158.80	14.29	—	I5B.	18121	114.30	136.50	9.53	—	I5B.	14605	115.00	130.00	13.00	—	I5B.
15549	111.10	158.80	14.29	—	I5C	15422	114.30	136.50	12.70	—	I5B.	11577	115.00	135.00	13.00	—	I5BB







# Retentores

Perfis - Ver Última Página



INCOVE VEDAÇÕES LTDA.

Cod.	Di	De	Ha1	Ha2	Mod	Cod.	Di	De	Ha1	Ha2	Mod	Cod.	Di	De	Ha1	Ha2	Mod
16127	120.00	160.00	19.40	—	15B	15633	120.70	158.80	14.29	—	15B.	23732	123.83	152.40	15.88	—	15B.
18195	120.00	170.00	15.00	—	15B.	15633	120.70	158.80	14.29	—	15C	23733	123.83	158.28	14.29	—	15B.
23693	120.00	180.00	12.70	—	15BB	13266	120.70	158.80	15.88	—	15B.	23734	123.83	158.75	11.91	—	15BA
2356	120.00	180.00	15.00	—	15B.	19162	120.70	161.90	14.29	—	15B.	23735	123.83	158.75	14.29	—	15B.
14027	120.60	152.58	14.29	—	17B.	17024	120.70	168.30	15.88	—	15B.	23736	123.83	161.93	12.70	—	15B.
14027	120.60	152.58	14.29	—	17B.	17024	120.70	168.30	15.88	—	15C	23737	123.83	168.28	12.70	—	15B.
14027	120.60	152.68	14.30	—	17B.	18195	120.70	169.90	19.05	—	15B.	23738	123.83	171.45	14.29	—	15B.
23694	120.65	142.88	15.88	—	15BB	18782	120.70	177.80	15.88	—	15B.	23739	124.00	150.00	15.00	—	15B.
16158	120.65	144.23	15.88	—	15BB	12707	121.00	147.00	13.00	—	15BB	25353	124.00	152.50	10.00	—	12BB
23695	120.65	146.05	9.53	—	15B.	13858	122.00	150.00	10.00	—	15B.	14614	124.00	170.00	14.00	—	18B.
23697	120.65	146.05	12.50	—	15BB	13884	122.00	150.00	12.00	—	112B	11709	124.50	145.00	12.00	—	18BB
23696	120.65	146.05	12.50	—	15B.	23717	122.00	150.00	12.00	—	12BB	13510	125.00	135.00	15.00	—	15BA
16486	120.65	146.05	12.70	—	12BB	23718	122.00	150.00	12.50	—	12B.	20249	125.00	140.00	7.50	—	14BA
23698	120.65	146.05	12.70	—	15B.	14613	122.00	150.00	13.00	—	15BB	12071	125.00	140.00	13.00	—	15BA
16486	120.65	146.05	12.70	—	12BB	14613	122.00	150.00	13.00	—	15B.	23740	125.00	140.00	13.00	—	15B.
16486	120.65	146.05	12.70	—	12BB	23720	122.00	150.00	15.00	—	15B.	22560	125.00	140.00	13.00	—	15BB
23699	120.65	146.05	14.29	—	15BB	23719	122.00	150.00	15.00	—	12BB	20268	125.00	143.00	13.00	—	12
23700	120.65	146.05	14.29	—	15B.	23721	122.00	159.00	13.00	—	15B.	12040	125.00	145.00	13.00	—	18BB
23701	120.65	146.05	15.88	—	15B.	.....	122.20	140.80	11.80	—	12BB	12876	125.00	145.00	13.00	—	15BB
23702	120.65	146.84	12.70	—	12B.	.....	122.20	140.80	12.00	—	12BB	20269	125.00	150.00	12.00	—	15B.
23703	120.65	149.23	14.29	—	15B.	17361	122.20	146.10	14.29	—	15BB	23742	125.00	150.00	12.00	—	15BB
23704	120.65	149.23	15.88	—	15B.	17852	122.20	146.10	19.05	—	17B.	23741	125.00	150.00	12.00	—	15BA
23705	120.65	152.40	12.70	—	15B.	19163	122.20	149.20	14.29	—	15B.	14615	125.00	150.00	13.00	—	15B.
23706	120.65	152.40	14.29	—	15BB	15095	122.20	152.40	6.35	—	14B.	14615	125.00	150.00	13.00	—	15BB
23707	120.65	152.40	15.88	—	15B.	14008	122.20	152.40	14.29	—	12B.	14615	125.00	150.00	13.00	—	15BB
12012	120.65	155.56	14.29	—	15B	19164	122.20	155.60	14.29	—	15B.	23743	125.00	150.00	13.00	—	15BA
23708	120.65	155.58	14.29	—	15B.	17444	122.20	155.60	15.88	—	15B.	14615	125.00	150.00	13.00	—	15BA
23709	120.65	155.58	15.88	—	15B.	17511	122.20	158.80	14.29	—	15B.	13000	125.00	150.00	13.00	—	12BB
23710	120.65	158.75	12.70	—	15BA	19165	122.20	161.90	14.29	—	15B.	23744	125.00	150.00	13.00	—	12BA
23711	120.65	158.75	14.29	—	15B.	15245	122.20	165.10	15.08	—	18BB	13000	125.00	150.00	13.00	—	12B.
23712	120.65	158.75	15.88	—	15B.	17654	122.20	165.10	15.88	—	15B.	14615	125.00	150.00	13.00	—	15BB
23713	120.65	161.93	12.70	—	15C	19926	122.20	165.10	25.40	—	ESPE	.....	125.00	150.00	13.00	—	12BB
11839	120.65	165.10	15.88	—	15JM	16113	122.23	15.40	6.35	—	15BB	13917	125.00	150.00	14.00	—	15BB
23714	120.65	168.28	15.88	—	15BA	23722	122.24	141.29	11.91	—	15BB	23745	125.00	150.00	14.00	—	15BB
23715	120.65	169.86	19.05	—	15B.	23723	122.24	146.05	12.70	—	15BB	13510	125.00	150.00	15.00	—	15B
22545	120.65	177.80	12.70	—	15BB	23724	122.24	146.05	14.29	—	15B.	20184	125.00	150.00	15.00	—	15JM
23716	120.65	177.80	15.88	—	15B.	23725	122.24	168.28	15.48	—	15B.	13510	125.00	150.00	15.00	—	15BB
19073	120.70	139.70	15.88	—	12B.	15095	122.50	152.40	6.35	—	14BA	13510	125.00	150.00	15.00	—	15BA
14860	120.70	142.90	4.76	—	14B.	20193	123.00	140.00	8.50	—	12BA	23746	125.00	150.00	15.00	—	15BA
15221	120.70	142.90	15.88	—	15B.	20193	123.00	140.00	8.50	—	12BA	11108	125.00	150.00	15.00	—	12B.
17022	120.70	146.10	12.70	—	15BB	23726	123.00	149.23	14.29	—	15B.	11108	125.00	150.00	15.00	—	12B.
17022	120.70	146.10	12.70	—	15BB	18036	123.00	150.00	27.00	—	ESPE	11108	125.00	150.00	15.00	—	12BA
17022	120.70	146.10	12.70	—	15BB	22556	123.00	152.40	14.29	—	12BB	23747	125.00	150.00	16.00	—	12BB
17022	120.70	146.10	12.70	—	15BB	11811	123.00	152.40	14.29	—	12BB	20396	125.00	155.00	10.00	—	15BA
13397	120.70	146.10	14.29	—	12B.	23727	123.00	163.00	15.00	—	15B.	23748	125.00	155.00	14.00	—	15BB
13398	120.70	146.10	15.88	—	15B.	19166	123.80	149.22	14.29	—	15BB	11821	125.00	155.00	14.00	—	15BA
17259	120.70	146.10	18.26	—	13B.	19166	123.80	149.22	14.29	—	15B.	23749	125.00	155.00	14.00	—	15B.
19983	120.70	147.20	12.70	—	13B.	11811	123.80	152.40	14.20	—	12B.	16149	125.00	155.00	14.00	—	12BB
17318	120.70	149.20	14.20	—	15B.	17113	123.80	152.40	15.88	—	15C	23750	125.00	155.00	14.00	—	12BA
13392	120.70	150.40	14.29	—	15B.	15716	123.80	152.40	27.00	—	18B.	16149	125.00	155.00	14.00	—	12BB
11263	120.70	152.00	12.70	—	15B.	17653	123.80	155.60	14.29	—	15C	23751	125.00	155.00	15.00	—	15B.
18207	120.70	152.40	9.53	—	13B.	12594	123.80	155.60	15.88	—	15B.	16913	125.00	155.00	16.00	—	15BB
18781	120.70	152.40	12.70	—	18B.	17354	123.80	158.80	14.29	—	15B.	12509	125.00	155.00	18.00	—	15JM
11503	120.70	152.40	12.70	—	15B.	17354	123.80	158.80	14.29	—	15C	16706	125.00	157.00	14.70	—	15JL
13393	120.70	152.40	14.29	—	12B.	17354	123.80	158.80	14.29	—	15BA	12847	125.00	160.00	12.00	—	15B
17417	120.70	152.40	15.88	—	15BB	18783	123.80	158.80	15.88	—	12B.	14616	125.00	160.00	12.00	—	15BB
17417	120.70	152.40	15.88	—	15B.	15912	123.80	165.10	15.88	—	15B.	23752	125.00	160.00	12.00	—	15BA
17417	120.70	152.40	15.88	—	15C	19167	123.80	168.30	14.29	—	15B.	14616	125.00	160.00	12.00	—	15B.
17043	120.70	152.40	23.81	—	15B.	15912	123.80	174.60	15.88	—	15B.	12847	125.00	160.00	12.00	—	12BB
17043	120.70	152.40	23.81	—	11FB	17328	123.80	182.60	9.53	—	F	14616	125.00	160.00	12.00	—	15BB
17851	120.70	155.60	15.88	—	15B.	16526	123.82	152.20	15.87	—	15BB	14616	125.00	160.00	12.00	—	15C
15801	120.70	158.80	6.35	—	14B.	20058	123.82	152.40	12.70	—	15JM	11336	125.00	160.00	13.00	—	15BB
15470	120.70	158.80	12.70	—	F	23728	123.83	140.49	15.88	—	15BA	23753	125.00	160.00	13.00	—	15B.
13589	120.70	158.80	12.70	—	15BA	22449	123.83	146.05	12.70	—	12BA	13511	125.00	160.00	15.00	—	15B.
13589	120.70	158.80	12.70	—	15BA	23729	123.83	147.64	11.11	—	15BB	13511	125.00	160.00	15.00	—	15BB
15633	120.70	158.80	14.24	—	15B.	23730	123.83	152.40	12.70	—	15BB	13511	125.00	160.00	15.00	—	15B.
15633	120.70	158.80	14.29	—	15BB	23731	123.83	152.40	14.29	—	12BB	13511	125.00	160.00	15.00	—	15BA





# Retentores

Perfis - Ver Última Página



INCOVE VEDAÇÕES LTDA.

Cod.	Di	De	Ha1	Ha2	Mod	Cod.	Di	De	Ha1	Ha2	Mod	Cod.	Di	De	Ha1	Ha2	Mod
11167	125.00	165.00	16.00	—	I5JL	11359	127.00	158.80	17.46	—	I2B.	16790	129.00	159.00	15.00	—	I2BB
23754	125.00	170.00	13.00	—	I5B.	13408	127.00	158.80	17.46	—	I2B.	23787	129.00	160.00	15.00	—	I5B.
23755	125.00	170.00	15.00	—	I5B.	13547	127.00	158.80	17.46	—	I1FB	25377	129.00	165.50	15.00	—	I5BB
23756	125.00	170.00	15.00	—	I2B.	18208	127.00	158.80	21.43	—	I12B	17179	129.80	142.90	9.53	—	F
23757	125.00	200.00	14.00	—	I2BB	17524	127.00	158.80	22.23	—	I3BC	16570	130.00	138.00	5.00	7.00	RASP
23758	125.00	258.00	16.00	—	I5BB	18788	127.00	158.80	25.40	—	I7B.	16450	130.00	140.00	13.00	—	I5BB
17128	125.40	152.40	14.29	—	I5BB	22510	127.00	158.90	14.29	—	I5B.	16860	130.00	140.00	14.00	—	I2BA
17128	125.40	152.40	14.29	—	I5B.	12608	127.00	159.00	13.00	—	I5BA	12974	130.00	145.00	9.00	—	I5BA
16241	125.40	152.40	15.80	—	I2B.	16109	127.00	160.00	13.00	—	I5B.	13948	130.00	150.00	10.00	—	I5B
16248	125.40	152.40	15.80	—	I2B.	13412	127.00	161.90	12.70	—	I5B.	16647	130.00	150.00	12.00	—	I5BA
16248	125.40	152.40	15.88	—	I2BA	17636	127.00	161.90	15.88	—	I5C	16909	130.00	150.00	13.00	—	I5BB
19169	125.40	155.60	14.29	—	I5B.	23772	127.00	161.93	14.29	—	I2B.	23788	130.00	150.00	15.00	—	I2BB
15706	125.40	158.80	14.29	—	I5B.	15860	127.00	165.00	16.00	—	I5B.	16872	130.00	150.00	16.00	—	I5BA
15706	125.40	158.80	14.29	—	I5B.	15860	127.00	165.00	16.00	—	I5B	14825	130.00	155.00	10.00	—	I5B.
18784	125.40	161.90	15.88	—	I5B.	15952	127.00	165.10	11.11	—	F	14825	130.00	155.00	10.00	—	I5BB
11861	125.40	162.00	12.70	—	I2BB	23773	127.00	165.10	12.70	—	I5BA	16386	130.00	155.00	10.00	—	I2B.
19171	125.40	168.30	14.29	—	I5B.	23774	127.00	165.10	15.88	—	I5B.	12688	130.00	155.60	21.50	—	I5B.
19172	125.40	171.50	14.29	—	I5B.	17979	127.00	165.10	20.64	—	I3B.	13512	130.00	160.00	12.00	—	I5BB
23760	125.41	146.05	11.11	—	I5B.	20272	127.00	167.10	16.00	—	I5B.	23791	130.00	160.00	12.00	—	I2BB
23761	125.41	152.40	12.70	—	I5B.	19931	127.00	168.30	14.29	—	I5B.	16521	130.00	160.00	12.00	—	I5JM
23762	125.41	158.75	13.10	—	I2BA	14794	127.00	168.30	23.81	—	I2B.	23789	130.00	160.00	12.00	—	I5BA
23763	125.41	161.93	15.88	—	I2B.	18789	127.00	171.50	15.88	—	I5B.	23790	130.00	160.00	12.00	—	I5B.
19170	125.41	165.10	14.10	—	I5B.	17966	127.00	171.50	17.46	—	I2B.	16521	130.00	160.00	12.00	—	ESPE
16426	126.00	171.00	19.00	—	I5BA	18790	127.00	174.60	15.88	—	I5B.	23791	130.00	160.00	12.00	—	I2BB
16126	126.90	158.75	12.70	—	I5BA	19173	127.00	177.80	14.29	—	I5B.	13512	130.00	160.00	12.00	—	I5BB
16657	127.00	146.05	11.11	—	I5BA	23775	127.00	180.98	14.29	—	I5B.	13512	130.00	160.00	12.00	—	I5BB
18664	127.00	146.10	11.11	—	I5JM	19174	127.00	181.00	12.70	—	I5B.	12644	130.00	160.00	13.00	—	I2BB
17861	127.00	146.10	12.70	—	I5B.	23776	127.00	184.15	12.70	—	I5B.	14617	130.00	160.00	13.00	—	I5BB
17861	127.00	146.10	12.70	—	I5B.	19175	127.00	184.20	14.29	—	I5B.	16782	130.00	160.00	13.00	—	I5JM
17861	127.00	146.10	12.70	—	I5BA	19176	127.00	187.30	14.29	—	I5B.	16782	130.00	160.00	13.00	—	I5JM
17861	127.00	146.10	12.70	—	I5BA	19177	127.00	190.50	14.29	—	I5B.	14617	130.00	160.00	13.00	—	I5BA
16263	127.00	146.20	7.92	—	I4BA	13673	127.80	153.20	12.70	—	I5JM	14617	130.00	160.00	13.00	—	I5B.
23764	127.00	146.84	12.70	—	I5BB	23777	128.00	146.00	13.50	—	I5B.	11358	130.00	160.00	13.00	—	I2BB
16356	127.00	150.00	12.00	—	I2B.	20273	128.00	146.00	13.50	—	I2	23792	130.00	160.00	13.00	—	I2BA
23765	127.00	152.00	24.61	—	I2B.	14733	128.00	150.00	13.00	—	I5BB	14617	130.00	160.00	13.00	—	I2B.
23767	127.00	152.40	12.70	—	I5BB	23778	128.00	150.00	13.00	—	I5B.	14617	130.00	160.00	13.00	—	I5BA
13410	127.00	152.40	12.70	—	I5BA	11092	128.00	150.00	15.00	—	I5BB	14617	130.00	160.00	13.00	—	I5BB
13410	127.00	152.40	12.70	—	I5B.	23779	128.00	150.00	15.00	—	I5BA	13526	130.00	160.00	14.00	—	I5BB
16566	127.00	152.40	12.70	—	I2BB	11926	128.00	156.00	12.00	—	I5BB	13526	130.00	160.00	14.00	—	I5B.
13907	127.00	152.40	12.70	—	I2BA	23780	128.00	160.00	15.00	—	I5B.	11368	130.00	160.00	14.00	—	I2BA
18122	127.00	152.40	12.70	—	I2B.	16829	128.00	160.80	12.00	—	I5BB	13526	130.00	160.00	14.00	—	I5BB
13907	127.00	152.40	12.70	—	I2BA	23781	128.00	180.98	14.29	—	I5B.	12644	130.00	160.00	15.00	—	I2BB
16566	127.00	152.40	12.70	—	I2BB	23782	128.00	184.15	14.29	—	I5B.	23793	130.00	160.00	15.00	—	I5BB
17604	127.00	152.40	15.88	—	I5BB	16730	128.50	136.00	10.50	12.00	I4B.	23794	130.00	160.00	15.00	—	I5BA
17604	127.00	152.40	15.88	—	I5B.	16674	128.50	165.30	16.00	—	I2B.	12644	130.00	160.00	15.00	—	I2BB
13834	127.00	152.40	15.88	—	I2B.	23783	128.59	155.58	12.70	—	I5B.	12644	130.00	160.00	15.00	—	I2B
17604	127.00	152.40	15.88	—	I5C	23784	128.59	158.75	14.29	—	I5BA	12644	130.00	160.00	15.00	—	I2BB
18786	127.00	152.40	23.81	—	I12B	23785	128.59	171.45	14.29	—	I5B.	12510	130.00	163.00	18.00	—	I5JM
18785	127.00	152.40	24.61	—	I7B.	23786	128.59	187.33	14.29	—	I5B.	23795	130.00	165.00	13.00	—	I5B.
11999	127.00	153.00	13.00	—	I5BA	13626	128.60	146.10	11.11	—	I5BB	20410	130.00	165.00	13.00	—	I5JL
15147	127.00	154.00	15.88	—	F	11230	128.60	155.60	12.70	—	I5BB	20085	130.00	165.00	14.00	—	I5BA
18787	127.00	155.60	15.88	—	I5B.	19178	128.60	155.60	12.70	—	I5B.	23796	130.00	165.00	17.00	—	I5BB
12444	127.00	158.70	12.70	—	I5B.	11341	128.60	155.60	12.70	—	I2BB	11580	130.00	165.00	18.00	—	I5JM
13408	127.00	158.70	15.80	—	I2B.	16391	128.60	155.60	12.70	—	I2B.	20418	130.00	168.00	14.00	—	I2BA
23768	127.00	158.75	12.70	—	I5B.	16245	128.60	155.60	12.70	—	I2B.	23797	130.00	170.00	12.00	—	I5BB
23769	127.00	158.75	12.70	—	I2BA	16391	128.60	155.60	12.70	—	I2B.	13916	130.00	170.00	13.00	—	I5BB
15209	127.00	158.75	14.29	—	I5B	19179	128.60	158.80	14.29	—	I5B.	23798	130.00	170.00	13.00	—	I5B.
11960	127.00	158.75	14.29	—	I5B.	18354	128.60	161.90	15.88	—	I5B.	13545	130.00	170.00	14.00	—	I4BA
23770	127.00	158.75	15.08	—	I2B.	19180	128.60	165.10	14.29	—	I5B.	14618	130.00	170.00	14.00	—	I5BB
20362	127.00	158.75	16.00	—	ESPE	19181	128.60	168.30	14.29	—	I5B.	14618	130.00	170.00	14.00	—	I5B.
23771	127.00	158.75	22.23	—	I2B.	19182	128.60	171.50	14.29	—	I5B.	12017	130.00	170.00	15.00	—	I5B.
11318	127.00	158.80	12.70	—	I5BA	19183	128.60	174.60	14.60	—	I5B.	23800	130.00	170.00	15.00	—	I5BB
13835	127.00	158.80	12.70	—	I2BA	19184	128.60	177.80	14.29	—	I5B.	11437	130.00	170.00	15.00	—	I5BA
13835	127.00	158.80	12.70	—	I2B.	19185	128.60	181.00	14.29	—	I5B.	11437	130.00	170.00	15.00	—	I5B.
13293	127.00	158.80	14.29	—	I2B.	19186	128.60	184.20	14.29	—	I5B.	23799	130.00	170.00	15.00	—	I2B.
13294	127.00	158.80	15.88	—	I5BB	19187	128.60	187.30	14.29	—	I5B.	11231	130.00	170.00	16.00	—	I5JM
13294	127.00	158.80	15.88	—	I5B.	19188	128.60	190.50	14.29	—	I5B.	23801	130.00	170.00	16.00	—	I5B.



# Retentores

Perfis - Ver Última Página



INCOVE VEDAÇÕES LTDA.

Cod.	Di	De	Ha1	Ha2	Mod	Cod.	Di	De	Ha1	Ha2	Mod	Cod.	Di	De	Ha1	Ha2	Mod
23802	130.00	170.00	16.00	---	I2BA	11973	133.00	160.20	14.00	---	I5BA	23852	134.54	180.98	14.29	---	I5B.
11231	130.00	170.00	16.00	---	I5JL	20281	133.00	163.00	14.50	---	I5B.	23853	134.54	182.56	15.88	---	I5BB
11231	130.00	170.00	16.00	---	I5JM	12256	133.30	158.75	13.00	---	I5BB	23854	134.54	187.33	14.29	---	I5B.
12706	130.00	171.50	13.00	---	I5BB	---	133.30	158.75	13.00	---	I2BB	23855	134.54	190.50	14.50	---	I5B.
13857	130.00	180.00	15.00	---	I5BB	23824	133.35	152.40	9.53	---	I5BA	15420	134.90	154.00	12.70	---	I5B.
13857	130.00	180.00	15.00	---	I5B.	23825	133.35	155.58	13.49	---	I5BA	13023	134.90	158.80	12.70	---	I5BB
18791	130.18	142.88	6.35	---	I4BA	23826	133.35	155.58	14.29	---	I2BA	19215	134.90	161.90	14.29	---	I5
23803	130.18	155.58	12.70	---	I5B.	23828	133.35	158.75	12.70	---	I5BB	15105	134.90	163.50	14.29	---	I5B.
23804	130.18	155.58	14.29	---	I5B.	22466	133.35	158.75	12.70	---	I5B.	15507	134.90	165.10	11.11	---	I8B.
23805	130.18	158.75	14.29	---	I5B.	23827	133.35	158.75	12.70	---	I5B.	18795	134.90	165.10	15.88	---	I5BB
23806	130.18	161.93	15.88	---	I5B.	23829	133.35	158.75	14.29	---	I5BA	18795	134.90	165.10	15.88	---	I5BA
23807	130.18	161.93	17.46	---	I2B.	22485	133.35	161.92	12.70	---	I2B.	18795	134.90	165.10	15.88	---	I5B.
23808	130.18	162.72	15.88	---	I5B.	11836	133.35	161.92	15.88	---	I5B.	19216	134.90	168.30	14.29	---	I5B.
17478	130.18	165.10	15.80	---	I5BB	23830	133.35	161.93	14.29	---	I5B.	19217	134.90	171.50	14.29	---	I5B.
17478	130.18	165.10	15.80	---	I5B.	23831	133.35	165.10	15.88	---	I2BB	19218	134.90	174.60	14.29	---	I5B.
23809	130.18	171.45	15.88	---	I5B.	23832	133.35	168.28	14.29	---	I5B.	19219	134.90	177.80	14.29	---	I5B.
23810	130.18	174.63	14.29	---	I5B.	23833	133.35	171.45	15.88	---	I5B.	19220	134.90	181.00	14.29	---	I5B.
23811	130.18	177.80	14.29	---	I5B.	23834	133.35	174.63	14.29	---	I5B.	19221	134.90	184.20	14.29	---	I5B.
23812	130.18	180.98	14.29	---	I5B.	23835	133.35	177.80	15.88	---	I5B.	19222	134.90	187.30	14.29	---	I5B.
23813	130.18	184.15	14.29	---	I5B.	23837	133.35	184.15	14.29	---	I5B.	19223	134.90	190.50	14.29	---	I5B.
23814	130.18	187.33	14.29	---	I5B.	23838	133.35	185.74	12.70	---	I5B.	20263	135.00	150.00	13.00	---	I5B.
23815	130.18	190.50	14.29	---	I5B.	23839	133.35	187.33	14.29	---	I5B.	14048	135.00	155.00	18.00	---	I3B.
19189	130.20	155.60	12.70	---	I5B.	23840	133.35	190.50	14.29	---	I5B.	16522	135.00	160.00	12.00	---	I5JM
11121	130.20	155.60	14.29	---	I5B.	17502	133.40	152.40	9.53	---	F	11760	135.00	160.00	12.00	---	I2BB
19190	130.20	158.80	14.29	---	I5B.	20206	133.40	155.75	14.00	---	I2BA	14620	135.00	160.00	13.00	---	I5B.
20274	130.20	161.90	12.70	---	I5B.	17208	133.40	155.90	14.00	---	I5BA	11760	135.00	160.00	13.00	---	I2B.
17477	130.20	161.90	15.88	---	I5BB	13376	133.40	158.80	12.70	---	I4BA	23856	135.00	160.00	13.00	---	I2B.
17477	130.20	161.90	15.88	---	I5B.	13375	133.40	158.80	12.70	---	I5BA	12445	135.00	160.00	14.00	---	I5BB
17477	130.20	161.90	15.88	---	I5C	13375	133.40	158.80	12.70	---	I5BB	12445	135.00	160.00	14.00	---	I5BB
13401	130.20	161.90	17.46	---	I2B.	17208	133.40	158.80	14.29	---	I5BA	12446	135.00	160.00	15.00	---	I5BB
15903	130.20	168.30	14.29	---	I5B.	17208	133.40	158.80	14.29	---	I5B.	12446	135.00	160.00	15.00	---	I5BA
15903	130.20	168.30	14.29	---	ESPE	19207	133.40	161.90	14.29	---	I5B.	12446	135.00	160.00	15.00	---	I5B.
18139	130.20	168.30	36.51	---	SANF	19207	133.40	161.90	14.29	---	I5B.	11472	135.00	165.00	13.00	---	I5BB
18792	130.20	171.50	15.88	---	I5B.	18314	133.40	161.90	15.88	---	F	23857	135.00	165.00	13.00	---	I5B.
19191	130.20	174.60	14.29	---	I5B.	13550	133.40	161.90	22.23	---	I1FB	23858	135.00	165.00	14.00	---	I5BB
19191	130.20	174.60	14.29	---	I5C	.....	133.40	165.05	23.00	---	I1FC	16085	135.00	165.00	14.00	---	I5B.
19192	130.20	177.80	15.00	---	I5C	17163	133.40	165.10	15.88	---	I5BB	12103	135.00	165.00	15.00	---	I4JL
19193	130.20	181.00	14.29	---	I5B.	17163	133.40	165.10	15.88	---	I5BB	23859	135.00	165.00	15.00	---	I5BB
19194	130.20	184.20	14.29	---	I5B.	17163	133.40	165.10	15.88	---	I5B.	23860	135.00	165.00	15.00	---	I5B.
19195	130.20	187.30	14.29	---	I5B.	12627	133.40	165.10	15.88	---	I2BA	22465	135.00	165.00	15.00	---	I2BB
19196	130.20	190.50	14.29	---	I5B.	17163	133.40	165.10	15.88	---	I5BA	18795	135.00	165.00	16.00	---	I5BB
15913	130.70	160.30	30.16	---	I2B.	17163	133.40	165.10	15.88	---	I5B.	18795	135.00	165.00	16.00	---	I5BA
11278	131.76	158.75	12.70	---	I2JL	17163	133.40	165.10	15.88	---	I5B.	18795	135.00	165.00	16.00	---	I5B.
23816	131.76	158.75	14.29	---	I5B.	17163	133.40	165.10	15.88	---	I5C	16162	135.00	165.00	16.00	---	I2BA
23818	131.76	165.10	15.88	---	I5B.	18117	133.40	165.10	23.81	---	I1FB	23861	135.00	165.00	16.00	---	I2B.
23819	131.76	184.15	14.29	---	I5B.	19208	133.40	168.30	14.29	---	I5B.	14621	135.00	168.00	15.00	---	I5B.
19197	131.80	158.80	12.70	---	I5B.	.....	133.40	171.50	15.88	---	I5B.	11515	135.00	170.00	12.00	---	I5BB
19198	131.80	161.90	14.29	---	I5B.	18265	133.40	171.50	19.05	---	I5JM	14622	135.00	170.00	13.00	---	I5B.
17856	131.80	165.10	15.88	---	I5BB	19209	133.40	174.60	15.88	---	I5B.	23862	135.00	170.00	13.00	---	I5B.
18793	131.80	165.10	27.78	---	I7B.	19210	133.40	177.80	15.88	---	I5B.	11820	135.00	170.00	14.00	---	I5BB
19199	131.80	168.30	14.29	---	I5B.	19211	133.40	181.00	14.29	---	I5B.	11820	135.00	170.00	14.00	---	I5BB
19200	131.80	171.50	14.29	---	I5B.	19212	133.40	184.20	14.29	---	I5B.	23863	135.00	170.00	14.00	---	I5BA
19201	131.80	174.60	14.29	---	I5B.	19899	133.40	185.70	12.70	---	I5B.	12500	135.00	170.00	15.00	---	I5JL
19202	131.80	177.80	14.29	---	I5B.	19213	133.40	187.30	14.29	---	I5B.	23864	135.00	170.00	15.00	---	I5B.
19203	131.80	181.00	14.29	---	I5B.	19214	133.40	190.50	14.29	---	I5B.	12511	135.00	170.00	18.00	---	I5JM
18097	131.80	182.60	15.88	---	I5B.	19039	133.40	190.50	25.40	---	I3C	23865	135.00	180.00	15.00	---	I5B.
19204	131.80	184.20	14.29	---	I5B.	14854	133.40	192.10	15.88	---	I5BB	14623	135.00	189.95	15.00	---	I5BB
19205	131.80	187.30	14.29	---	I5B.	23841	134.54	153.99	12.70	---	I5B.	14623	135.00	190.00	15.00	---	I5BB
19206	131.80	190.50	14.29	---	I5B.	23842	134.54	155.58	9.53	---	I5BB	14623	135.00	190.00	15.00	---	I5BB
23820	132.00	150.00	13.00	---	I5BB	23843	134.54	158.75	12.70	---	I5BB	23866	135.00	190.00	15.00	---	I5BA
23821	132.00	160.00	13.00	---	I5BB	23844	134.54	160.34	15.88	---	I2B.	20285	135.00	192.00	16.00	---	I5BB
16883	132.00	160.00	15.00	19.00	I4B.	23845	134.54	161.93	14.29	---	I5B.	23867	135.00	192.00	16.00	---	I5BB
23822	132.00	160.00	15.00	---	I5BB	23846	134.54	165.10	15.88	---	I5B.	23868	135.00	210.00	15.00	---	I5BB
16962	132.00	165.00	15.00	---	I5BB	23847	134.54	168.28	14.29	---	I5B.	36926	135.00	---	---	---	ANEL
12246	133.00	160.00	15.00	---	I2BB	23849	134.54	171.45	14.29	---	I5B.	16398	136.00	152.00	8.50	---	I5BA
12246	133.00	160.00	15.00	---	I2BB	23850	134.54	174.63	14.29	---	I5B.	16781	136.00	160.00	14.00	---	I2BB
12246	133.00	160.00	15.00	---	I2BB	23851	134.54	177.80	14.29	---	I5B.	20384	136.00	165.00	15.50	---	ESPE



# Retentores

Perfis - Ver Última Página



INCOVE VEDAÇÕES LTDA.

Cod.	Di	De	Ha1	Ha2	Mod	Cod.	Di	De	Ha1	Ha2	Mod	Cod.	Di	De	Ha1	Ha2	Mod
20334	136.00	165.00	16.00	---	I9B.	23882	139.70	158.75	12.70	---	I2BA	13558	140.00	170.00	14.00	---	I5B.
13552	136.00	180.00	12.00	---	I5BA	14628	139.70	158.75	12.70	---	I2BA	11013	140.00	170.00	14.00	---	I2B.
11404	136.50	161.90	12.70	---	I5BB	18319	139.70	160.30	30.16	---	I2B.	12519	140.00	170.00	14.00	---	I4BA
15954	136.50	161.90	14.29	---	F	23883	139.70	160.34	30.16	---	I2BA	11148	140.00	170.00	15.00	---	I5JL
18796	136.50	161.90	15.80	---	I5B.	.....	139.70	165.05	31.70	---	ESPE	13558	140.00	170.00	15.00	---	I5TG
18797	136.50	165.10	14.29	---	I5B.	13462	139.70	165.10	12.70	---	I5BB	23908	140.00	170.00	15.00	---	I5BB
18798	136.50	165.10	26.99	---	I7B.	23884	139.70	165.10	12.70	---	I5B.	13558	140.00	170.00	15.00	---	I5B.
18799	136.50	165.10	26.99	---	I9B.	23885	139.70	165.10	12.70	---	I2BB	11174	140.00	170.00	15.00	---	I2BB
11986	136.50	168.20	12.70	---	I2B.	11238	139.70	165.10	14.29	---	I5BB	11174	140.00	170.00	15.00	---	I2BA
16758	136.50	168.20	15.90	---	I5JM	18802	139.70	165.10	15.88	---	I5B.	11174	140.00	170.00	15.00	---	I2B.
12869	136.50	168.30	12.70	---	I5B.	19006	139.70	168.30	19.32	---	I5B.	13558	140.00	170.00	15.00	---	I5B.
13394	136.50	168.30	14.29	---	I5BB	23886	139.70	171.45	12.70	---	I2BA	11174	140.00	170.00	15.00	---	I2BB
13394	136.50	168.30	14.29	---	I5BA	16233	139.70	171.45	12.70	---	I5B.	11040	140.00	170.00	16.00	---	I5B.
19987	136.50	168.30	14.29	---	I2BB	16364	139.70	171.45	14.28	---	I5B.	23909	140.00	170.00	16.00	---	I2B.
13394	136.50	168.30	14.29	---	I5C	23887	139.70	171.45	14.29	---	I5B.	11040	140.00	170.00	16.00	---	I5BB
11550	136.50	168.30	15.88	---	I2BB	23888	139.70	171.45	15.88	---	I2B.	23910	140.00	170.00	24.00	---	I2BB
17020	136.50	168.30	15.88	---	I5B.	23889	139.70	171.45	16.67	---	I2B.	22454	140.00	171.00	13.00	---	I2BA
15997	136.50	168.30	15.88	---	I7B.	23890	139.70	171.45	19.05	---	I2B.	12586	140.00	171.00	14.50	---	I5BA
19987	136.50	168.30	15.90	---	I5B.	15773	139.70	171.50	15.88	---	I5C	11714	140.00	172.00	15.60	---	I5BB
19987	136.50	168.30	15.90	---	I2B.	15773	139.70	171.50	15.88	---	I5BB	11758	140.00	172.00	15.60	---	I5JM
19892	136.50	169.90	14.29	---	I5B.	15773	139.70	171.50	15.88	---	I5BA	12448	140.00	173.00	18.00	---	I5B.
19013	136.50	169.90	14.29	---	I8B.	15773	139.70	171.50	15.88	---	I5B.	11590	140.00	173.00	18.00	---	I5JM
18350	136.50	171.50	15.88	---	I5B.	15773	139.70	171.50	15.88	---	I5B.	14869	140.00	174.00	23.00	---	I2B
19225	136.50	174.60	14.29	---	I5B.	22487	139.70	171.60	12.70	---	I2BA	14869	140.00	174.00	23.50	---	I2B.
19226	136.50	177.80	12.70	---	I5B.	19238	139.70	174.60	14.29	---	I5BB	12179	140.00	175.00	18.00	---	I5BA
19227	136.50	181.00	14.29	---	I5B.	13632	139.70	174.60	22.22	---	I2B.	12730	140.00	175.00	20.00	---	I5BA
19228	136.50	184.20	14.29	---	I5B.	23891	139.70	174.63	12.70	---	I2BA	13513	140.00	180.00	12.00	---	I5B.
19229	136.50	187.30	14.29	---	I5B.	23892	139.70	174.63	14.29	---	I5B.	13513	140.00	180.00	12.00	---	I5BB
19230	136.50	190.50	14.29	---	I5B.	23893	139.70	174.63	20.64	---	I2B.	13514	140.00	180.00	13.00	---	I5B.
11859	136.52	158.75	12.70	---	I7B.	23894	139.70	177.80	14.29	---	I5B.	12842	140.00	180.00	14.00	---	I5BA
23869	136.53	161.93	15.88	---	I5BB	23895	139.70	177.80	15.88	---	I5BB	14626	140.00	180.00	15.00	---	I5B
23869	136.53	165.10	14.29	---	I5B.	23896	139.70	180.98	14.29	---	I5B.	23911	140.00	180.00	15.00	---	I5BB
16908	136.53	165.10	14.29	---	I2BB	19241	139.70	184.10	14.29	---	I5B.	14626	140.00	180.00	15.00	---	I5B.
23870	136.53	165.10	15.88	---	I2B.	23897	139.70	187.33	14.29	---	I5B.	23912	140.00	180.00	15.00	---	I2BA
23871	136.53	168.28	12.70	---	I2B.	25454	139.70	190.50	9.50	---	I5BA	14626	140.00	180.00	15.00	---	I5B.
23872	136.53	168.28	14.29	---	I2B.	23898	139.70	190.50	14.29	---	I5B.	18178	140.00	180.00	15.00	---	F
23873	136.53	168.28	15.88	---	I5BB	23899	139.70	200.82	14.29	---	I2B.	11027	140.00	180.00	15.00	---	I2BB
23874	136.53	168.28	15.88	---	I2BA	14628	139.75	158.75	12.70	---	I5BA	12740	140.00	180.00	16.00	---	I5BB
16271	136.53	171.45	15.88	---	I5BB	12447	140.00	155.00	9.00	---	I5B.	12785	140.00	180.00	16.50	---	I5JL
23875	136.53	171.45	15.88	---	I5BB	20284	140.00	160.00	9.50	---	I5BB	23913	140.00	185.00	16.00	---	I5BB
23876	136.53	177.80	14.29	---	I5B.	20284	140.00	160.00	9.50	---	I5B.	23912	140.00	185.00	16.00	---	I2BA
25411	137.00	160.50	12.00	---	I5BB	16712	140.00	160.00	10.00	14.00	I5B.	14627	140.00	185.00	18.00	---	I5B.
11809	137.00	170.70	13.00	---	I5BB	14624	140.00	160.00	12.00	---	I5BB	23914	140.00	190.00	15.00	---	I5B.
12553	138.00	160.00	15.00	---	I5BA	20320	140.00	160.00	12.00	---	I2BB	23915	140.00	200.00	14.00	---	I5BB
23877	138.00	160.00	15.00	---	I5B.	14624	140.00	160.00	12.00	---	I5B	12736	141.00	168.30	17.00	---	I7BA
12681	138.00	160.00	15.00	---	I2B.	23900	140.00	160.00	13.00	---	I5BA	19244	141.29	168.27	14.29	---	I5BB
16502	138.00	165.00	15.00	---	I5BA	13888	140.00	160.00	15.00	---	I5B.	23916	141.29	168.28	14.29	---	I5B.
16502	138.00	165.00	15.00	---	I5B.	23901	140.00	160.00	15.00	---	I2BA	19245	141.29	171.45	14.29	---	I5BB
23879	138.00	170.00	15.00	---	I5B.	13462	140.00	165.00	12.00	13.00	I5BB	19245	141.29	171.45	14.29	---	I5B.
15164	138.10	163.50	7.94	---	F	23902	140.00	165.00	13.00	---	I5B.	23917	141.29	174.63	14.29	---	I5B.
11392	138.10	168.30	12.70	---	I5BB	13462	140.00	165.00	13.00	---	I5BB	23918	141.29	177.80	14.29	---	I5B.
19231	138.10	168.30	14.29	---	I5B.	18802	140.00	165.00	15.00	---	I5B.	23919	141.29	184.15	14.29	---	I5B.
18800	138.10	171.50	15.88	---	I5B.	23903	140.00	165.00	15.00	---	I2BA	23920	141.29	187.33	14.29	---	I5B.
19232	138.10	174.60	14.29	---	I5B.	.....	140.00	165.00	15.00	---	I2BA	23921	141.29	190.50	14.29	---	I5B.
19233	138.10	177.80	14.29	---	I5B.	20032	140.00	165.00	18.00	---	I5BB	17262	142.87	168.27	15.88	---	ESPE
19234	138.10	181.00	14.29	---	I5B.	20201	140.00	166.00	15.00	---	I5B.	17262	142.87	168.27	15.88	---	I5C
12306	138.10	184.20	12.00	38.00	ESPE	20201	140.00	166.00	15.00	---	I5BB	19251	142.87	180.97	14.29	---	I5JM
19235	138.10	184.20	14.29	---	I5B.	20033	140.00	168.00	14.50	---	I5B.	23922	142.88	168.28	12.70	---	I5BB
19236	138.10	187.30	14.29	---	I5B.	23905	140.00	170.00	12.00	---	I5BB	23923	142.88	168.28	14.29	---	I5B.
19236	138.10	187.30	14.29	---	I5BB	23904	140.00	170.00	12.00	---	I2BB	23924	142.88	168.28	15.88	---	I5B.
19237	138.10	190.30	14.29	---	I5B.	14625	140.00	170.00	13.00	---	I5BA	23925	142.88	168.28	19.05	---	I5BB
23880	138.11	168.28	12.70	---	I5BB	14625	140.00	170.00	13.00	---	I5BA	11546	142.88	171.40	14.30	---	I2BB
16176	139.00	170.00	12.00	---	I2B.	14625	140.00	170.00	13.00	---	I5BB	11546	142.88	171.40	14.30	---	I2BB
19021	139.00	174.00	48.00	---	SANF	23906	140.00	170.00	13.00	---	I5B.	23926	142.88	171.45	14.29	---	I5BB
20102	139.60	171.50	11.80	---	I5B.	14625	140.00	170.00	13.00	---	I5BB	23927	142.88	174.63	12.70	---	I5B.
11858	139.60	171.50	16.00	---	I2B.	13558	140.00	170.00	14.00	---	I5BA	23928	142.88	177.80	14.29	---	I5B.
23881	139.70	128.28	11.91	---	I5B.	23907	140.00	170.00	14.00	---	I5BB	23929	142.88	180.98	14.29	---	I5B.





# Retenfores

Perfis - Ver Última Página



INCOVE VEDAÇÕES LTDA.

Cod.	Di	De	Ha1	Ha2	Mod	Cod.	Di	De	Ha1	Ha2	Mod	Cod.	Di	De	Ha1	Ha2	Mod
23930	142.88	184.15	14.29	—	I5B.	11928	145.00	180.00	15.00	—	I5BB	23994	149.23	184.15	14.29	—	I5B.
23931	142.88	187.33	14.29	—	I5B.	23962	145.00	180.00	15.00	—	I5B.	23995	149.23	187.33	14.29	—	I5B.
23932	142.88	190.50	14.29	—	I5B.	13616	145.00	184.00	16.00	—	I5B.	23996	149.23	190.50	14.29	—	I5B.
11355	142.90	168.45	15.90	—	I2BB	13616	145.00	184.00	16.00	—	I5BA	22464	149.23	203.20	19.05	—	I5BB
19250	142.90	171.05	14.30	—	I5BB	12502	145.00	190.00	20.00	—	I5B.	16136	150.00	168.00	13.00	—	I5BA
16108	142.90	174.78	13.00	—	I2B.	13623	145.00	200.00	19.00	—	I5B.	12735	150.00	170.00	10.00	—	I5B.
12449	142.90	174.78	15.88	—	I5C	17209	146.00	168.25	16.00	—	I5B.	11864	150.00	170.00	12.00	—	I5BA
17901	142.90	181.13	22.20	—	I3C	17209	146.00	168.00	15.87	—	I5B.	11033	150.00	170.00	15.00	—	I5BB
12008	143.00	168.00	13.00	—	I5BB	17486	146.00	178.00	16.00	—	I5BB	11033	150.00	170.00	15.00	—	I5BA
12185	143.00	168.00	16.00	—	I5B.	23964	146.05	168.28	15.88	—	I5BB	23998	150.00	170.00	15.00	—	I5B.
12971	143.00	176.50	12.70	—	I5B.	23963	146.05	168.28	15.88	—	I5B.	11033	150.00	170.00	15.00	—	I5B.
23933	143.00	225.00	16.00	—	I2BA	23965	146.05	171.45	12.30	—	I5B.	13072	150.00	172.00	18.00	—	I5BA
12303	143.30	150.00	39.50	—	ESPE	20388	146.05	171.45	12.30	—	I2BA	23999	150.00	172.00	18.50	—	I5BB
23934	144.00	160.00	12.00	—	I5BA	20390	146.05	171.45	12.70	—	I5BB	24000	150.00	175.00	10.00	—	I5BA
25375	144.00	166.50	12.70	—	I2TG	22462	146.05	171.45	15.88	—	I5B.	12875	150.00	175.00	13.00	—	I5B.
11511	144.00	175.50	15.50	—	I5BB	16527	146.05	171.45	19.05	—	I5BB	14631	150.00	175.00	14.30	—	I5C
23935	144.07	174.63	18.02	—	I2B.	23966	146.05	174.63	14.29	—	I5B.	15741	150.00	178.00	12.00	—	I5BB
18287	144.20	171.00	10.00	—	F	23967	146.05	177.80	12.70	—	I5BA	15741	150.00	178.00	13.00	—	I5B.
23936	144.46	168.67	19.05	—	I2B.	23968	146.05	177.80	14.29	—	I5B.	24001	150.00	180.00	8.00	—	I5BB
23937	144.46	171.45	14.29	—	I5B.	13402	146.05	177.80	15.87	—	I5C	16444	150.00	180.00	8.00	—	I2BA
23938	144.46	174.63	14.29	—	I5B.	13402	146.05	177.80	15.87	—	I5BB	14632	150.00	180.00	12.00	—	I5BB
23940	144.46	177.80	14.29	—	I5B.	13402	146.05	177.80	15.87	—	I5B.	14632	150.00	180.00	13.00	—	I5BB
23941	144.46	180.98	14.29	—	I5B.	13402	146.05	177.80	15.87	—	I5BB	14632	150.00	180.00	13.00	—	I5BB
23943	144.46	184.15	14.29	—	I5B.	13402	146.05	177.80	15.87	—	I5BB	14632	150.00	180.00	13.00	—	I5B.
23944	144.46	184.15	15.88	—	I5B.	23969	146.05	179.39	15.88	—	I5BB	14632	150.00	180.00	13.00	—	I5BB
23945	144.46	187.33	14.29	—	I5B.	23970	146.05	180.98	14.29	—	I5B.	24002	150.00	180.00	14.00	—	I2B.
23946	144.46	190.50	14.29	—	I5B.	23971	146.05	184.15	14.29	—	I5B.	24003	150.00	180.00	14.00	—	I2BB
11056	144.50	171.50	12.70	—	I5BB	23972	146.05	187.33	14.29	—	I5B.	12862	150.00	180.00	15.00	—	I2BB
15849	144.80	190.30	16.00	—	F	19266	146.05	190.50	14.29	—	I5B	—	150.00	180.00	15.00	—	I2BB
13544	145.00	165.00	10.00	—	I5B.	23973	146.05	190.50	14.29	—	I5B.	13515	150.00	180.00	15.00	—	I5BB
13663	145.00	165.00	13.00	—	I5BB	19266	146.05	190.50	14.29	—	I5B.	24004	150.00	180.00	15.00	—	I5BA
16290	145.00	165.00	13.00	—	I5B.	23974	146.05	200.03	19.05	—	I5B.	13515	150.00	180.00	15.00	—	I5B.
13663	145.00	165.00	13.00	—	I5B.	12812	146.10	177.80	15.87	—	I5B	12862	150.00	180.00	15.00	—	I2BB
23948	145.00	165.00	15.00	—	I5B.	13574	146.10	184.20	26.19	—	I7B	12862	150.00	180.00	15.00	—	I2BB
23949	145.00	165.00	19.00	—	I5B.	16965	147.00	168.00	13.00	—	I5BA	12862	150.00	180.00	15.00	—	I2BA
11950	145.00	168.00	16.00	—	I5B.	23976	147.00	174.63	14.29	—	I5B.	24005	150.00	180.00	15.00	—	I2B.
23952	145.00	170.00	12.70	—	I2B	23977	147.00	180.00	11.00	—	I5BB	—	150.00	180.00	15.00	—	I2BA
13686	145.00	170.00	13.00	—	I5BB	20171	147.00	180.00	12.00	—	I5BB	13515	150.00	180.00	15.00	—	I5BB
13686	145.00	170.00	13.00	—	I5BA	23978	147.00	180.98	12.70	—	I2B.	13515	150.00	180.00	15.00	—	I5TG
23951	145.00	170.00	13.00	—	I5B.	23979	147.00	180.98	14.29	—	I5B.	20003	150.00	180.00	20.00	—	I5B.
16366	145.00	170.00	13.00	—	I2BB	23980	147.00	181.37	15.88	—	I5B.	20392	150.00	180.00	—	—	I2JL
23954	145.00	170.00	14.00	—	I5BB	23981	147.00	184.15	14.29	—	I5B.	24005	150.00	182.70	16.00	—	I5BA
23953	145.00	170.00	14.00	—	I5BA	23982	147.00	187.33	14.29	—	I5BA	20013	150.00	185.00	18.00	—	I5JM
23955	145.00	170.00	14.00	—	I5B.	23983	147.00	190.50	14.29	—	I5B.	20013	150.00	185.00	18.00	—	I5BA
23956	145.00	170.00	14.00	—	I2BA	23984	147.00	191.00	14.00	—	I5BB	12450	150.00	186.00	20.00	—	I5B.
13913	145.00	170.00	15.00	—	I5B.	16832	147.60	181.30	15.80	—	I5BB	17506	150.00	190.00	15.00	—	I5BB
11881	145.00	170.00	15.00	—	I5BB	19270	147.63	184.15	14.29	—	I5B.	14633	150.00	196.00	16.00	—	I5B.
23957	145.00	170.00	15.00	—	I5BA	11410	148.00	170.00	14.50	—	I2B.	24006	150.00	200.00	13.00	—	I5BB
23959	145.00	170.00	15.00	—	I5BA	23985	148.00	170.00	15.00	—	I5B.	20312	150.00	200.00	15.00	—	I5B.
23958	145.00	170.00	15.00	—	I5B.	16628	148.00	172.00	15.00	—	I5BB	20312	150.00	200.00	15.00	—	I5B.
11323	145.00	170.00	15.00	—	I2BA	23986	148.00	180.00	15.00	—	I5BB	11022	150.00	200.00	15.00	—	I2BB
11323	145.00	170.00	15.00	—	I2B.	14630	148.00	180.00	15.00	—	I5B.	14634	150.00	200.00	20.00	—	I5B.
16084	145.00	175.00	5.00	—	I5BB	23987	148.00	190.00	15.00	—	I5B.	24008	150.00	200.00	20.00	—	I5BB
14629	145.00	175.00	13.00	—	I5BB	16622	149.00	171.00	14.00	—	I5BB	24007	150.00	200.00	20.00	—	I5BA
—	145.00	175.00	13.00	—	I5B.	20335	149.00	181.00	16.00	—	I9B.	16530	150.00	250.00	15.00	—	I5BB
—	145.00	175.00	14.00	—	I2BB	13439	149.20	181.00	12.70	—	I2B.	16153	150.40	176.65	10.60	—	I2BB
14629	145.00	175.00	14.00	—	I5BB	18014	149.20	181.00	14.29	—	I5B	19276	150.80	177.80	14.29	—	I2B
25434	145.00	175.00	15.00	—	I5BB	14009	149.20	181.00	20.64	—	I5B	12649	150.80	178.00	12.50	—	I2BB
11099	145.00	175.00	15.00	—	I2BB	13431	149.20	181.20	16.00	—	I5C	12327	150.80	229.40	28.60	—	DISC
11099	145.00	175.15	15.00	—	I2BA	17506	149.20	190.50	14.29	—	I5B.	12327	150.80	229.40	28.60	—	DISC
17486	145.00	178.00	14.00	—	I5B.	17012	149.22	174.62	12.70	—	I5BB	24009	150.81	177.80	12.50	—	I2BB
17486	145.00	178.00	14.00	—	I5B.	23988	149.23	171.45	14.29	—	I5B.	24010	150.81	177.80	12.70	—	I5B.
23960	145.00	180.00	12.00	—	I5BB	23989	149.23	174.63	12.70	—	I5B.	11887	150.81	177.80	14.28	—	I5B.
14795	145.00	180.00	13.00	—	I5BA	23990	149.23	177.80	12.70	—	I5B.	24011	150.81	180.98	14.29	—	I5B.
14795	145.00	180.00	13.00	—	I5BB	23991	149.23	180.98	12.70	—	I2B.	22498	150.81	180.98	15.88	—	I2B.
23961	145.00	180.00	13.00	—	I5BB	23992	149.23	180.98	15.88	—	I5B.	24012	150.81	182.56	15.88	—	I5BB
14795	145.00	180.00	13.00	—	I5B.	23993	149.23	180.98	15.88	—	I2BB	24013	150.81	184.15	14.29	—	I5B.



Cod.	Di	De	Ha1	Ha2	Mod	Cod.	Di	De	Ha1	Ha2	Mod	Cod.	Di	De	Ha1	Ha2	Mod
24014	150.81	187.33	14.29	—	I5B.	24049	155.58	187.33	14.29	—	I5B.	12178	160.00	195.00	18.00	—	I5BA
24015	150.81	190.50	14.29	—	I5B.	24050	155.58	190.50	14.29	—	I5B.	12178	160.00	195.00	18.00	—	I5JM
24016	150.81	193.68	14.29	—	I5B.	24051	155.58	190.50	14.29	—	I2B.	12452	160.00	196.00	20.00	—	I5BB
24017	152.00	181.50	14.00	—	I5BB	11532	155.58	193.68	19.05	—	I2BB	13006	160.00	200.00	12.00	—	I5BB
11055	152.00	190.00	19.00	—	I5BB	11064	155.58	193.69	15.87	—	I5B.	16528	160.00	200.00	12.00	—	I5JM
24018	152.00	191.50	18.00	—	I5BB	12198	155.60	184.20	13.50	—	I5BB	24069	160.00	200.00	12.00	—	I5BB
11347	152.20	173.00	11.80	—	I5BB	12839	155.60	190.50	15.08	—	I7B	13006	160.00	200.00	12.00	—	I5BB
12579	152.40	158.80	6.35	—	I4BA	17413	155.60	190.50	15.87	—	I5JL	14641	160.00	200.00	14.00	—	I5BB
16683	152.40	171.45	4.76	—	I4BA	14636	156.00	183.00	13.00	—	I5BB	24070	160.00	200.00	14.00	—	I5B.
24019	152.40	171.45	9.53	—	I5B.	24052	156.00	183.00	13.00	—	I5B.	14641	160.00	200.00	14.00	—	I5BB
24020	152.40	171.45	11.91	—	I5BB	16432	156.00	196.50	16.00	—	I5BA	14641	160.00	200.00	14.00	—	I5BB
14451	152.40	171.45	12.70	—	I5BA	24053	156.37	190.50	19.05	—	I5B.	22511	160.00	200.00	15.00	—	I5B.
14451	152.40	171.45	12.70	—	I2BA	20079	157.00	178.00	13.50	—	I5BB	12880	160.00	200.00	15.00	—	I2BB
13689	152.40	171.50	11.90	—	I2BA	14718	157.00	181.00	11.00	—	I5BA	24071	160.00	200.00	15.00	—	I2BA
13689	152.40	171.50	11.90	—	I2BA	14718	157.00	181.00	11.20	—	I5BA	11177	160.00	200.00	16.00	—	I5BB
24021	152.40	177.80	11.11	—	I2BA	14718	157.00	181.00	11.50	—	I5BA	11177	160.00	200.00	16.00	—	I5JM
24022	152.40	177.80	12.70	—	I5B.	16350	157.00	184.00	13.50	—	I5BB	12880	160.00	200.00	16.00	—	I2
24023	152.40	177.80	12.70	—	I2BB	20122	157.00	185.00	12.00	—	I5B.	13829	160.00	200.00	19.50	—	I5B.
24024	152.40	177.80	15.88	—	I5B.	24054	157.16	169.85	19.45	—	I5B.	12059	160.00	225.00	19.00	—	I5JM
24025	152.40	179.39	19.05	—	I2B.	24055	157.16	180.98	11.11	—	I5B.	20213	160.00	254.00	16.30	—	I5B.
24026	152.40	180.98	14.29	—	I5B.	16256	157.16	184.15	19.05	—	I5BB	20213	160.00	254.00	16.30	—	I5BB
24027	152.40	180.98	15.88	—	I2B.	16890	157.16	184.15	19.05	—	I2BA	11063	160.34	190.50	15.87	—	I5JL
24028	152.40	184.15	14.29	—	I5BA	16890	157.16	184.15	19.05	—	I2BA	12236	161.90	187.30	9.50	—	I5BB
11213	152.40	184.20	14.29	—	I2BB	15097	157.16	190.50	6.35	—	I4BA	13361	161.90	200.20	19.05	—	I2B.
19283	152.40	187.33	14.29	—	I5B	24056	157.16	190.50	14.29	—	I5B.	18356	161.92	187.32	15.87	—	I5C
16019	152.40	190.50	12.70	—	I5BB	12759	157.30	193.80	19.23	—	ESPE	17145	161.92	196.85	19.05	—	I5B.
16019	152.40	190.50	12.70	—	I5B.	24057	157.56	180.98	11.11	—	I5B.	17145	161.92	196.85	19.05	—	I5C
24030	152.40	190.50	12.70	—	I5B.	11560	158.00	178.00	24.50	—	ESPE	24072	161.93	187.33	9.53	—	I5BB
20415	152.40	190.50	12.70	—	I2BA	24058	158.00	180.00	15.00	—	I5BB	24073	161.93	187.33	11.11	—	I5BB
15498	152.40	190.50	14.28	—	I5B.	24059	158.00	186.00	15.00	—	I5B.	24074	161.93	187.33	15.88	—	I5B.
12873	152.40	190.50	14.29	—	I2BA	22559	158.70	190.00	18.00	—	I7BA	24076	161.93	190.50	14.29	—	I5B.
25421	152.40	190.50	14.70	—	I2JL	11798	158.70	196.85	14.28	—	I5B.	19292	161.93	190.50	14.02	—	I5B.
12874	152.40	190.50	15.87	—	I5BB	11451	158.72	214.32	14.30	—	I2BB	24077	161.93	193.68	14.29	—	I5B.
12874	152.40	190.50	15.87	—	I5BA	17342	158.75	182.56	15.87	—	I5BB	11931	161.93	200.02	19.05	—	I5BA
24033	152.40	190.50	15.88	—	I5B.	17342	158.75	182.56	15.87	—	I5C	11931	161.93	200.02	19.05	—	I5B.
16519	152.40	190.50	17.00	—	I5BB	12199	158.75	190.50	14.28	—	I5BB	24078	161.93	200.03	19.50	—	I2B.
24034	152.40	190.50	19.05	—	I5BB	12970	158.75	196.85	19.05	—	I5JM	24079	161.93	200.03	20.64	—	I2B.
16980	152.40	190.50	19.50	—	I5B.	18811	158.75	196.85	19.05	—	I5BA	24080	161.93	203.20	19.05	—	I5B.
24035	152.40	193.68	19.05	—	I5BB	13782	158.80	187.30	15.87	—	I5B.	24081	161.93	209.55	15.88	—	I5B.
19284	152.40	193.70	14.29	—	I5B.	17698	158.80	193.70	19.05	—	I5B.	24082	162.00	190.00	12.00	—	I5BB
24036	153.00	190.00	16.00	—	I5BB	24060	159.00	185.00	16.00	—	I5B.	16125	162.00	190.00	15.00	—	I5B.
12191	153.06	172.30	12.00	—	I5BB	13464	159.00	191.00	19.00	—	I5BB	12828	162.00	200.00	13.00	—	I5B.
12956	153.06	172.30	24.00	—	I7C	24061	160.00	175.00	15.00	—	I5B.	24083	162.00	200.00	19.00	—	I5B.
19285	153.99	190.50	14.29	—	I5B.	14637	160.00	180.00	10.00	—	I8BB	16597	162.00	200.30	12.50	—	I2B.
12799	154.00	200.00	15.00	—	I5BB	14638	160.00	180.00	13.00	—	I5B.	14610	163.50	197.00	6.40	—	I4BA
24037	155.00	174.00	12.00	—	I5BB	24062	160.00	180.00	14.00	—	I5B.	24084	163.51	190.50	12.70	—	I5B.
22450	155.00	174.00	12.00	—	I5BA	12870	160.00	180.00	15.00	—	I5B.	24085	163.51	190.50	14.29	—	I5B.
24038	155.00	175.00	12.00	—	I2BB	12870	160.00	180.00	15.00	—	I5BB	24086	163.51	196.85	19.05	—	I5B.
16048	155.00	180.00	13.00	—	I5BB	14639	160.00	185.00	10.00	—	I5BB	24087	165.00	180.00	13.00	—	I5BB
24039	155.00	180.00	13.00	—	I5BB	24063	160.00	185.00	10.00	—	I5BA	20243	165.00	185.00	10.00	—	I5BB
14635	155.00	180.00	15.00	—	I5BB	24064	160.00	185.00	12.00	—	I5BB	14642	165.00	190.00	13.00	—	I5BB
14635	155.00	180.00	15.00	—	I5B.	11413	160.00	185.00	12.00	—	I5BB	24090	165.00	190.00	13.00	—	I2BA
20172	155.00	185.00	12.00	—	I5BB	16123	160.00	185.00	15.00	—	I5BB	14642	165.00	190.00	13.00	—	I5JL
24040	155.00	190.00	13.00	—	I5BB	11014	160.00	190.00	9.00	—	I5BA	24088	165.00	190.00	13.00	—	I5BB
24042	155.00	190.00	15.00	—	I2B.	24065	160.00	190.00	9.00	—	I5BA	24089	165.00	190.00	13.00	—	I5BA
17860	155.00	190.00	15.00	—	I5BB	14640	160.00	190.00	13.00	—	I5BB	24090	165.00	190.00	13.00	—	I2BA
24043	155.00	190.00	15.00	—	I5BA	14640	160.00	190.00	13.00	—	I5B.	14642	165.00	190.00	13.00	—	I5BB
17860	155.00	190.00	15.00	—	I5B.	24067	160.00	190.00	14.00	—	I5B.	14642	165.00	190.00	13.00	—	I5BA
24044	155.00	200.00	15.00	—	I5BB	13516	160.00	190.00	15.00	—	I5BB	12917	165.00	190.00	15.00	—	I5B.
12451	155.00	200.00	22.50	—	I2	13516	160.00	190.00	15.00	—	I5BB	24091	165.00	190.00	15.00	—	I5B.
13463	155.18	190.50	19.05	—	I5B.	24068	160.00	190.00	15.00	—	I5BA	12917	165.00	190.00	15.00	—	I5BA
11991	155.50	190.55	13.00	—	I5JL	13516	160.00	190.00	15.00	—	I5BA	22455	165.00	190.50	12.70	—	I2BA
11848	155.50	190.55	15.87	—	I5JL	11029	160.00	190.00	15.00	—	I2BB	12640	165.00	190.85	12.70	—	I5BB
17023	155.57	193.67	19.05	—	I5C	11029	160.00	190.00	15.00	—	I2BB	20176	165.00	195.00	12.50	—	I5BB
24045	155.58	180.98	12.70	—	I5BA	22516	160.00	190.00	15.00	—	I2B.	11147	165.00	195.00	15.00	—	I5JL
24046	155.58	180.98	15.88	—	I5B.	16336	160.00	190.00	16.00	—	I2BA	24093	165.00	200.00	12.00	—	I5B.
24048	155.58	184.15	14.29	—	I5B.	11182	160.00	190.00	17.00	—	I5BA	19297	165.00	200.00	15.00	—	I5B



# Retentores

Perfis - Ver Última Página



INCOVE VEDAÇÕES LTDA.

Cod.	Di	De	Ha1	Ha2	Mod	Cod.	Di	De	Ha1	Ha2	Mod	Cod.	Di	De	Ha1	Ha2	Mod
19297	165.00	200.00	15.00	—	15BA	19307	169.86	196.85	15.88	—	15B.	19315	174.62	203.20	14.29	—	15B.
24094	165.00	205.00	16.00	—	15BB	16145	170.00	190.00	13.00	—	15BB	13573	174.62	203.20	15.00	—	15BA
22437	165.00	205.00	16.00	—	12BB	13777	170.00	190.00	15.00	—	15B.	13573	174.62	203.20	15.88	—	15B.
12503	165.00	220.00	20.00	—	15BA	16410	170.00	200.00	12.50	—	15JL	20314	174.62	203.20	19.05	—	15BB
24095	165.10	177.80	19.05	—	15BB	24129	170.00	200.00	13.00	—	15BA	20314	174.62	203.20	19.05	—	15BB
24096	165.10	184.15	15.48	—	15BA	11214	170.00	200.00	13.00	—	15BB	11623	174.62	212.95	15.87	—	15JM
24097	165.10	185.75	14.29	—	15B.	11034	170.00	200.00	15.00	—	15BB	24154	174.63	206.38	14.29	—	15B.
12710	165.10	186.53	14.28	—	15BA	22530	170.00	200.00	15.00	—	15JM	24155	174.63	209.55	14.29	—	15B.
24099	165.10	190.00	12.70	—	15BB	11034	170.00	200.00	15.00	—	15B.	24156	174.63	209.55	20.64	—	15BA
24098	165.10	190.00	12.70	—	12BA	11023	170.00	200.00	15.00	—	12BB	24157	174.63	212.73	15.88	—	15B.
24100	165.10	190.00	14.29	—	15BB	24130	170.00	200.00	15.00	—	12BA	16900	174.63	212.73	15.88	—	12BB
24101	165.10	190.00	22.23	—	15B.	11034	170.00	200.00	15.00	—	15BB	17266	174.63	212.73	19.05	—	15BB
13745	165.10	190.50	15.87	—	15B.	11023	170.00	200.00	15.00	—	12BB	24159	174.63	215.90	20.64	—	15B.
18814	165.10	190.65	14.30	—	15B.	14643	170.00	200.00	16.00	—	15B.	24160	174.63	219.08	14.29	—	15B.
25460	165.10	190.70	13.00	—	15B.	24131	170.00	200.00	16.00	—	15BA	24161	174.63	222.25	14.29	—	15B.
18814	165.10	190.70	14.20	—	15BB	11256	170.00	200.00	16.00	—	12BA	14644	175.00	200.00	13.00	—	15BA
18814	165.10	190.70	14.28	—	15B.	14643	170.00	200.00	16.00	—	15BA	14644	175.00	200.00	13.00	—	15BB
18814	165.10	190.70	14.28	—	15BA	11256	170.00	200.00	16.00	—	12BA	14644	175.00	200.00	13.00	—	15B.
12280	165.10	193.65	15.70	—	15B.	24132	170.00	206.00	15.00	—	15B.	13517	175.00	200.00	15.00	—	15JL
22488	165.10	193.68	14.29	—	15B.	12453	170.00	206.00	20.00	—	15BB	13517	175.00	200.00	15.00	—	12BB
24102	165.10	193.68	15.88	—	15B.	13878	170.00	210.00	15.00	—	15B.	13517	175.00	200.00	15.00	—	15B.
19295	165.10	193.70	14.28	—	15B.	11486	170.00	210.00	16.00	—	15BA	13517	175.00	200.00	15.00	—	15BB
16179	165.10	196.65	15.87	—	15BB	16157	170.00	210.00	20.00	—	15JM	24162	175.00	200.00	16.00	—	15B.
16259	165.10	196.65	17.00	—	15BB	16157	170.00	210.00	20.00	—	12BB	11933	175.00	203.00	16.00	—	15BA
24104	165.10	196.85	14.29	—	15B.	24133	170.00	213.00	19.00	—	15B.	24163	175.00	205.00	15.00	—	15BB
24105	165.10	200.03	14.29	—	15B.	11633	170.00	215.00	16.00	—	15BB	24164	175.00	210.00	16.00	—	15BA
17320	165.10	203.00	19.00	—	15BA	11633	170.00	215.00	16.00	—	15B.	16796	175.00	213.00	15.88	—	15JM
24106	165.10	203.20	12.70	—	15B.	24134	170.00	220.00	12.00	—	15BB	24165	175.00	215.00	16.00	—	15B.
13387	165.10	203.20	12.70	—	15B.	24135	170.00	220.00	20.00	—	15B.	16956	175.00	215.07	12.00	—	15BB
24107	165.10	203.20	19.05	—	15B.	16546	170.00	225.00	20.00	—	15BA	16274	175.00	215.07	16.00	—	12B.
17320	165.10	203.20	19.05	—	15B.	11851	171.40	208.20	17.00	—	15JM	14768	175.00	220.00	15.00	—	15B.
24108	165.10	203.20	25.40	—	12B.	15991	171.45	196.85	12.70	—	15JL	18817	176.00	206.00	9.50	—	15BA
17498	165.10	203.20	25.40	—	15C	24136	171.45	196.85	14.29	—	15B.	16047	176.00	206.00	15.00	—	15B.
19982	165.10	206.80	12.70	—	19B	12937	171.45	196.85	19.05	—	15JL	16047	176.00	206.00	15.00	—	15BB
24109	165.10	212.73	19.05	—	15B.	12937	171.45	196.85	19.05	—	15BB	24166	176.21	206.38	15.88	—	15B.
24110	165.10	215.90	12.70	—	12B.	24137	171.45	203.20	14.29	—	15BA	24167	176.21	206.38	19.05	—	15B.
24111	165.10	215.90	15.88	—	15B.	24138	171.45	203.20	15.88	—	15BA	24168	176.21	212.13	14.29	—	15B.
13627	166.70	209.60	22.22	—	15BA	12856	171.45	203.20	19.05	—	15BB	24169	176.21	215.90	14.29	—	15B.
12705	167.00	191.00	17.00	—	15BB	16174	171.45	203.20	19.05	—	12BB	15208	177.50	146.10	14.29	—	15B.
11715	168.00	188.00	31.70	—	12BA	24140	171.45	206.38	14.29	—	15B.	24170	177.80	203.20	15.88	—	15B.
24112	168.00	190.00	15.00	—	15B.	22475	171.45	209.55	12.70	—	15B.	24171	177.80	203.20	15.88	—	12BB
24113	168.00	200.00	15.00	—	15B.	24141	171.45	209.55	15.88	—	15B.	24172	177.80	203.20	19.05	—	15B.
11850	168.00	203.20	19.00	—	15JL	11387	171.45	209.55	17.46	—	15BB	17868	177.80	203.43	19.00	—	15B.
11757	168.15	203.15	19.05	—	15JL	24143	171.45	209.55	19.05	—	15B.	17868	177.80	203.43	19.00	—	15B.
11757	168.15	203.15	19.05	—	15JM	24144	171.45	209.55	19.05	—	15B.	24173	177.80	206.38	14.29	—	15B.
19302	168.20	109.55	14.29	—	15B.	24145	171.45	212.73	14.29	—	15B.	24174	177.80	207.96	15.88	—	15B.
19302	168.20	209.55	14.29	—	15B.	24147	171.45	215.90	14.29	—	15B.	12782	177.80	209.55	15.87	—	15BA
13901	168.27	200.02	16.69	—	15BB	24148	171.45	219.08	14.29	—	15B.	24175	177.80	209.55	15.88	—	15B.
13902	168.27	204.60	17.46	—	15BB	24149	171.45	222.25	14.29	—	15B.	18818	177.80	209.55	19.05	—	15BB
12928	168.27	206.37	19.00	—	15B.	12108	171.50	196.90	12.70	—	15BB	24176	177.80	209.55	19.05	—	15B.
18815	168.28	190.50	14.29	—	15B.	19309	171.50	200.00	14.29	—	15BB	18818	177.80	209.55	19.05	—	15B.
18815	168.28	190.50	14.29	—	15BA	11862	171.50	203.15	16.00	—	15JL	19323	177.80	212.72	14.28	—	15B.
24115	168.28	190.50	31.75	—	12BA	11981	171.50	203.15	16.00	—	15JM	24177	177.80	212.73	14.29	—	15B.
24116	168.28	193.68	14.29	—	15BB	12789	171.50	209.60	19.05	—	15B.	24178	177.80	212.73	15.88	—	15BA
22432	168.28	193.68	15.87	—	15B.	24150	172.00	152.40	14.29	—	15B.	24179	177.80	212.73	15.88	—	12BB
24117	168.28	193.68	15.88	—	15BB	24151	172.00	200.00	15.00	—	15B.	24180	177.80	212.73	19.05	—	15B.
24118	168.28	196.85	14.29	—	15B.	24152	172.00	216.00	19.00	—	15B.	24181	177.80	215.90	12.70	—	12B.
24119	168.28	200.03	14.29	—	15B.	12825	172.00	216.00	25.00	—	11FC	11868	177.80	215.90	15.87	—	15C
24120	168.28	203.20	14.29	—	15B.	12825	172.00	216.00	25.00	—	15B.	18307	177.80	215.90	15.88	—	12BA
24121	168.28	206.38	12.70	—	15B.	12490	172.80	229.40	11.80	28.80	DISC	24183	177.80	215.90	15.88	—	15BA
24122	168.28	206.38	15.88	—	15B.	24153	174.00	177.80	14.29	—	15B.	17188	177.80	215.90	19.05	—	15BB
24123	168.28	209.55	14.29	—	15B.	16457	174.00	192.00	13.00	—	15JM	17188	177.80	215.90	19.05	—	15B.
24124	168.28	212.73	14.29	—	15B.	17266	174.40	212.90	19.00	—	15B.	17188	177.80	215.90	19.05	—	15C
24125	168.28	215.90	14.29	—	15B.	20093	174.42	202.30	236.30	45.00	ESPE	17260	177.80	215.90	22.22	—	19C
24126	168.28	219.08	14.29	—	15B.	19319	174.42	222.25	14.29	—	15B.	17260	177.80	216.08	22.20	—	15C
24127	168.28	222.25	14.29	—	15B.	16112	174.60	200.25	16.00	—	15B.	24187	177.80	219.08	14.29	—	15B.
17261	168.30	206.40	15.87	—	15B.	19316	174.60	206.40	15.87	—	15B.	24188	177.80	219.08	19.05	—	15B.







# Retentores

Perfis - Ver Última Página



INCOVE VEDAÇÕES LTDA.

Cod.	Di	De	Ha1	Ha2	Mod	Cod.	Di	De	Ha1	Ha2	Mod	Cod.	Di	De	Ha1	Ha2	Mod
20353	195.00	235.00	16.00	—	I5B.	14787	200.00	285.80	31.75	—	I3C	16096	209.55	234.95	12.70	—	I5B.
24297	195.00	235.00	20.00	—	I5B.	18238	200.02	254.00	25.40	—	I5B.	16096	209.55	234.95	12.70	—	I5BB
24298	196.00	230.00	18.00	—	I2B.	24323	200.03	215.50	15.88	—	I5BB	24375	209.55	234.95	15.88	—	I5B.
11838	196.65	222.25	11.11	—	I5B.	24324	200.03	220.15	15.88	—	I5B.	24376	209.55	238.13	15.88	—	I5B.
24299	196.85	214.30	19.05	—	I5B.	24325	200.03	222.25	15.88	—	I5B.	16175	209.55	241.30	15.87	—	I2BB
24300	196.85	219.08	15.88	—	I5B.	24326	200.03	225.43	15.88	—	I5B.	24377	209.55	241.30	15.88	—	I5B.
19351	196.85	222.20	15.87	—	I5JL	24327	200.03	228.60	11.11	—	I5B.	18834	209.55	241.30	19.05	—	I5B.
19351	196.85	222.20	15.87	—	I5B.	24328	200.03	228.60	11.11	—	I2BB	24378	209.55	247.65	15.88	—	I2B.
24301	196.85	222.25	11.11	—	I5BA	24330	200.03	231.78	15.88	8.00	I5B.	24379	209.55	254.00	19.05	—	I5B.
24302	196.85	222.25	12.70	—	I5B.	24331	200.03	233.36	17.46	—	I5B.	16182	209.55	254.50	33.30	—	I7JL
24303	196.85	225.43	15.88	—	I5BB	24332	200.03	233.36	19.05	—	I5B.	24380	209.55	260.35	17.46	—	I5B.
22496	196.85	228.60	15.87	—	I5BA	24333	200.03	234.95	15.88	—	I5B.	24381	209.55	266.70	20.64	—	I5B.
24304	196.85	228.60	15.88	—	I5B.	24334	200.03	238.13	19.05	—	I5B.	12709	209.60	241.30	22.22	—	I5B.
24305	196.85	231.78	15.88	—	I5B.	24335	200.03	238.13	25.40	—	I5B.	12018	209.60	241.30	22.22	—	I7B.
24306	196.85	234.95	15.88	—	I2BA	24336	200.03	238.13	31.75	—	I5B.	24382	210.00	240.00	13.00	—	I5B.
16680	196.85	234.95	16.00	—	I2BA	24337	200.03	241.30	15.88	—	I5B.	14651	210.00	240.00	13.00	16.00	I8BB
16680	196.85	234.95	16.00	—	I2BA	24338	200.03	241.30	19.05	—	I5B.	24383	210.00	240.00	14.00	—	I5B.
18828	196.85	234.95	19.05	—	I5B.	24339	200.03	254.00	19.05	—	I2B.	12601	210.00	240.00	15.00	—	I5BB
24307	196.85	234.95	23.81	—	I2B.	24340	200.03	254.00	25.40	—	I5B.	24384	210.00	240.00	15.00	—	I5BA
11266	196.90	222.30	11.11	—	I5B.	16610	200.30	225.40	19.05	—	I5B.	12601	210.00	240.00	15.00	16.00	I5B.
17324	196.90	235.00	19.05	—	I5JM	24341	201.61	231.78	15.88	—	I5B.	20105	210.00	240.00	15.00	16.00	I2BB
16819	197.00	204.00	19.00	—	I5C	24342	201.61	239.71	19.05	—	I5B.	24385	210.00	240.00	16.00	—	I5B.
11504	197.00	235.00	15.00	—	I5BB	24343	203.00	230.00	15.00	—	I5BB	11026	210.00	245.00	15.00	16.00	I5B.
16708	198.00	225.50	19.05	—	I5B.	16759	203.00	235.00	19.50	—	I5JM	12459	210.00	249.00	22.00	—	I5B.
25400	198.00	310.00	15.00	—	I5BB	16353	203.00	254.00	19.00	—	I2B	11543	210.00	250.00	15.00	—	I2BB
25443	198.40	233.40	19.05	—	I2B	16353	203.00	254.00	19.00	—	I2B.	14830	210.00	250.00	16.00	—	I5B.
24308	200.00	215.00	30.00	—	I2BA	16353	203.00	254.00	19.00	—	I2B.	14830	210.00	250.00	16.00	—	I5JM
13750	200.00	226.00	13.00	—	I5JM	24344	203.00	270.00	16.00	—	I5BB	24386	210.00	250.00	16.00	—	I5BB
13750	200.00	226.00	13.00	—	I5BB	24345	203.20	228.60	12.70	—	I5BB	24387	210.00	260.00	16.00	—	I5B.
11084	200.00	228.60	11.10	—	I5JL	24346	203.20	228.60	15.88	—	I5B.	24388	210.00	260.00	25.00	—	I5B.
11084	200.00	228.60	11.10	—	I2BB	24347	203.20	228.60	15.88	—	I2BB	24389	212.00	266.70	19.00	—	I5B.
24309	200.00	230.00	12.50	—	I5BA	18832	203.20	228.60	19.05	—	I5B.	24390	212.73	247.65	19.05	—	I5B.
11576	200.00	230.00	13.00	—	I5BB	22544	203.20	229.20	12.70	—	I5BB	24391	212.73	250.83	17.46	—	I5BB
12237	200.00	230.00	15.00	—	I5BB	19368	203.20	231.78	15.88	—	DISC	24392	212.73	263.53	19.05	—	I5B.
24310	200.00	230.00	15.00	—	I5B.	19368	203.20	231.78	15.88	—	I5B.	11583	213.00	250.00	16.00	—	I5BB
24311	200.00	230.00	15.00	—	I2BA	19977	203.20	232.60	17.46	—	I3B.	17480	214.30	248.46	25.40	—	I3BC
12237	200.00	230.00	15.00	—	I5BB	24349	203.20	233.36	15.88	—	I5BB	17480	214.30	248.46	25.40	—	I9B.
14648	200.00	230.00	16.00	—	I5BA	24350	203.20	237.95	19.05	—	I5B.	24393	214.31	254.00	15.88	—	I5B.
14648	200.00	230.00	16.00	—	I5BB	19369	203.20	238.10	15.88	—	I5BA	24394	215.00	240.00	12.00	—	I5BB
14648	200.00	230.00	16.00	—	I5B	24351	203.20	238.13	16.00	—	I5B.	22436	215.00	240.00	12.00	—	I2BB
14648	200.00	230.00	16.00	—	I5BB	24352	203.20	238.13	19.05	—	I5B.	11987	215.00	240.00	12.00	—	I5B
14648	200.00	230.00	16.00	—	I5JM	11208	203.20	241.30	15.87	—	I5B.	12472	215.00	240.00	15.00	—	I2
16152	200.00	230.00	17.00	—	I2B.	12801	203.20	241.30	15.88	—	I5JM	12685	215.00	245.00	16.00	—	I5BA
16152	200.00	230.00	17.00	—	I2B.	24353	203.20	241.30	17.46	—	I5B.	11360	215.00	250.00	16.00	—	I5BB
11015	200.00	230.00	18.00	—	I5BB	17411	203.20	241.30	19.05	—	I5B.	16363	215.00	250.00	16.00	—	I5B.
24313	200.00	235.00	16.00	—	I2BA	24354	203.20	250.83	19.05	—	I5B.	11360	215.00	250.00	16.00	—	I5BB
24314	200.00	235.00	18.00	—	I5BA	16609	203.20	254.00	15.90	—	I2B.	24396	215.00	270.00	26.00	—	I2B.
11087	200.00	235.00	18.00	—	I2BA	24355	203.20	254.00	17.46	—	I5B.	25452	215.90	241.30	15.87	—	I5B.
15488	200.00	238.10	19.05	—	I5B	17479	203.20	254.00	19.05	—	I5B.	25452	215.90	241.30	15.87	—	I5JL
14649	200.00	240.00	16.00	—	I5B.	13804	203.20	254.00	19.05	—	I2B.	20383	215.90	241.30	17.46	—	I5B.
14649	200.00	240.00	16.00	—	I5BB	24358	203.20	254.00	22.23	—	I5BA	12772	215.90	247.65	15.87	—	I5B.
24315	200.00	240.00	16.00	—	I2BB	24359	203.20	254.00	24.61	—	I2B.	24397	215.90	247.65	19.05	—	I5B.
16018	200.00	240.00	16.00	—	I5JL	14650	205.00	230.00	10.00	—	I5B.	25321	215.90	254.00	19.05	—	I5B.
16547	200.00	240.00	20.00	—	I5B.	12057	205.00	230.00	15.00	—	I5BA	18838	215.90	254.00	19.05	—	I5B.
16547	200.00	240.00	20.00	—	I5JM	24366	205.00	230.00	15.00	—	I5BA	11622	215.90	254.00	19.05	—	I2JM
16547	200.00	240.00	20.00	—	I5BA	16077	205.00	230.00	16.00	—	I5B.	24398	215.90	266.70	15.88	—	I2BA
24316	200.00	240.00	20.00	—	I5B.	11234	205.00	240.00	16.00	—	I5JM	24399	215.90	266.70	17.46	—	I5B.
24317	200.00	240.00	20.00	—	I2BA	24367	205.00	250.00	15.00	—	I5B.	24400	215.90	266.70	17.46	—	I2BA
15861	200.00	241.30	19.05	—	I5B	24368	205.00	250.00	16.00	—	I5B.	22515	215.90	266.70	19.05	—	I5C
24318	200.00	245.00	12.00	—	I5BA	12764	205.00	255.00	25.00	—	I5B.	22515	215.90	266.70	19.05	—	I5B.
11528	200.00	245.00	20.00	—	I5BB	12458	205.00	260.00	23.00	—	I5B.	13432	215.90	266.70	25.40	—	I5B
13784	200.00	250.00	15.00	—	I5B.	24369	206.00	257.00	25.00	—	I5B.	22452	215.90	266.90	15.88	—	I2BA
24319	200.00	250.00	15.00	—	I5BB	19374	206.37	250.82	19.05	—	I5B.	11770	215.90	269.87	25.40	—	I2BA
24320	200.00	250.00	16.00	—	I5B.	24370	206.38	244.48	19.05	—	I5B.	11770	215.90	269.87	25.40	—	I2B.
12879	200.00	250.00	16.00	—	I2BB	24371	206.38	247.65	19.05	—	I5B.	24401	215.90	269.88	19.05	—	I2B.
24321	200.00	250.00	16.00	—	I2BA	24373	206.38	254.00	19.05	—	I5B.	24402	215.90	269.88	25.40	—	I2BB
20086	200.00	270.00	15.00	—	I5B.	24374	206.38	257.18	19.05	—	I5B.	13805	215.90	269.90	19.05	—	I2B



# Retentores

Perfis - Ver Última Página



INCOVE VEDAÇÕES LTDA.

Cod.	Di	De	Ha1	Ha2	Mod	Cod.	Di	De	Ha1	Ha2	Mod	Cod.	Di	De	Ha1	Ha2	Mod
24403	216.00	261.00	17.30	—	I5B.	16761	225.42	254.00	15.80	—	I5BA	24477	231.78	273.05	17.46	—	I5B.
24404	218.00	250.00	16.00	—	I5B.	11637	225.42	285.75	15.87	—	I2B.	24478	231.78	273.05	19.05	—	I5B.
19382	219.07	260.35	19.05	—	I2BB	24440	225.43	247.65	14.29	—	I5B.	24479	231.78	276.23	19.05	—	I5B.
24405	219.08	246.86	25.40	—	I5B.	24441	225.43	257.18	19.05	—	I5B.	24480	231.78	279.40	19.05	—	I5B.
24406	219.08	257.18	19.05	—	I5B.	24442	225.43	263.53	19.05	—	I5B.	18847	231.78	282.58	25.40	—	I5B.
24407	219.08	260.35	19.05	—	I5B.	24443	225.43	265.40	16.00	—	I5BB	24482	233.36	269.88	15.88	—	I5B.
24408	219.08	263.53	19.05	—	I5B.	24444	225.43	276.23	19.05	—	I5B.	16399	234.00	260.00	15.80	—	I5BA
24410	219.08	266.70	12.70	—	I5BB	24445	225.43	276.23	20.64	—	I5B.	24483	234.95	254.00	11.11	—	I5B.
24409	219.08	266.70	12.70	—	I5B.	24446	225.43	276.23	25.00	—	I5B.	24484	234.95	260.35	15.88	—	I5B.
24411	219.08	266.70	24.61	—	I2B.	16405	226.70	240.00	12.70	—	I5B.	24485	234.95	263.53	19.05	—	I5B.
16671	219.08	269.88	17.46	—	I5B.	24448	227.00	255.00	12.70	—	I5BB	24486	234.95	266.70	12.70	—	I5B.
24412	219.08	269.88	25.40	—	I5B.	20034	227.00	270.00	17.50	—	I5B.	24487	234.95	269.88	19.05	—	I5B.
24413	219.08	273.05	25.40	—	I5B.	12721	227.00	285.00	19.00	—	I5B.	24488	234.95	273.05	17.46	—	I5B.
19384	219.10	266.70	19.50	—	I5B.	11778	228.40	268.40	17.00	—	I5JL	24489	234.95	273.05	19.05	—	I5B.
24414	220.00	230.00	16.00	—	I5B.	16215	228.40	268.40	17.00	—	I5JL	24490	234.95	276.23	19.05	—	I5B.
16103	220.00	235.00	16.00	—	I5BB	24449	228.60	254.00	12.70	—	I5B.	24491	234.95	282.58	19.05	—	I5B.
24415	220.00	240.00	10.00	—	I5BA	22616	228.60	254.00	15.80	—	I5B.	24492	234.95	285.75	15.88	—	I2BA
13587	220.00	250.00	11.00	—	I5B.	13435	228.60	254.00	19.05	—	I5B.	24493	234.95	285.75	19.05	—	I5B.
24416	220.00	250.00	11.00	—	I5BB	24450	228.60	254.00	22.23	—	I2B.	24494	234.95	285.75	25.40	—	I5B.
13587	220.00	250.00	11.00	—	I5BA	24451	228.60	257.18	15.88	—	I5B.	22514	234.95	285.95	15.80	—	I2B.
14652	220.00	250.00	15.00	—	I5BB	24452	228.60	260.35	19.05	—	I5B.	24495	234.95	288.93	19.05	—	I5B.
14652	220.00	250.00	15.00	—	I5BA	24453	228.60	263.53	15.88	—	I5B.	24496	234.95	292.10	19.05	—	I5B.
24418	220.00	250.00	15.00	—	I5B.	24454	228.60	266.70	17.46	—	I5B.	24497	234.95	323.85	31.75	—	I2B.
24419	220.00	250.00	15.00	—	I2B.	24455	228.60	266.70	19.05	—	I5BB	24498	235.00	260.00	12.70	—	I5BB
13586	220.00	250.00	16.00	—	I5BA	24456	228.60	266.70	19.05	—	I2B.	24499	235.00	265.00	16.00	—	I5B.
24420	220.00	250.00	16.00	—	I2BA	25439	228.60	269.40	14.00	—	I5BA	24500	235.00	270.00	13.00	—	I5BB
13586	220.00	250.00	16.00	—	I5B.	19393	228.60	269.40	15.87	—	I5B.	24501	235.00	270.00	15.00	—	I5BA
25426	220.00	250.00	18.00	—	I2BB	24457	228.60	269.88	15.88	—	I5B.	13918	235.00	270.00	16.00	—	I5B.
11020	220.00	255.00	18.00	—	I5B.	20385	228.60	273.00	19.05	—	I5B.	12628	235.00	270.00	18.00	—	I5B.
24421	220.00	255.00	41.00	—	I5B.	20385	228.60	273.00	19.05	—	I2B.	12062	235.00	279.40	34.93	—	I7BA
12826	220.00	258.00	19.00	—	I5BB	24458	228.60	273.84	25.40	—	I5B.	12765	235.00	285.00	25.00	—	I5B.
11694	220.00	260.00	14.00	—	I5B.	24459	228.60	279.40	16.67	—	I2BB	16243	235.00	286.00	16.00	—	I2BB
16752	220.00	260.00	16.00	—	I2BB	24460	228.60	279.40	17.46	—	I5B.	13772	235.00	287.75	19.60	—	I5B.
16752	220.00	260.00	16.00	—	I2BB	16810	228.60	279.40	19.00	—	I5JM	11772	236.50	285.80	15.87	—	I2B.
11912	220.00	260.00	18.00	—	I2BB	17496	228.60	279.40	25.40	—	I5BB	13708	237.00	286.00	19.00	—	I5C
13097	220.00	260.00	20.00	—	I5JM	12978	228.60	279.45	19.40	—	I5B.	13708	237.00	286.00	19.00	—	I5B.
11019	220.00	260.00	22.00	—	I5BA	17496	229.40	279.40	25.40	—	I5B.	24502	237.13	276.23	19.05	—	I5B.
24422	220.00	260.00	22.00	—	I2BA	24461	230.00	253.00	11.50	—	I5BB	12667	238.00	286.00	17.00	—	I5C
16014	220.00	262.00	15.00	—	I5JM	24462	230.00	255.00	10.00	—	I5BA	11674	238.00	292.00	20.50	—	I5BB
24423	220.00	270.00	15.00	—	I5B.	16682	230.00	255.00	15.00	—	I5B.	19414	238.10	279.70	19.05	—	I5BB
24424	220.00	270.00	25.00	—	I5C	24463	230.00	255.00	15.00	—	I5BB	18012	238.10	289.20	25.40	—	I5B.
20341	220.00	275.00	23.00	—	I5BA	24464	230.00	256.00	12.70	—	I5BB	18012	238.10	289.20	25.40	—	I5B.
20341	220.00	275.00	23.00	—	I5BA	14661	230.00	260.00	15.00	—	I5BB	24503	238.13	279.40	19.05	—	I5B.
24425	220.00	275.00	23.00	—	I5B.	24465	230.00	260.00	15.00	—	I5BA	24504	238.13	282.58	19.05	—	I5B.
24426	220.00	275.00	23.00	—	I2BA	16289	230.00	260.00	15.00	—	I5B.	24505	238.13	285.75	19.05	—	I5B.
12717	222.00	260.00	19.00	—	I5B.	24466	230.00	260.00	15.00	—	I5B.	24506	238.13	288.93	25.40	—	I5B.
11628	222.00	260.00	19.00	—	I2	24467	230.00	260.00	15.00	—	I2B.	24507	238.13	292.10	19.05	—	I5B.
24428	222.25	254.00	15.88	—	I5B.	11492	230.00	260.00	15.00	—	I2BB	24508	239.71	266.70	15.88	—	I5B.
24429	222.25	254.00	15.88	—	I2BB	14661	230.00	260.00	15.00	—	I5BB	24509	239.71	266.70	19.05	—	I5B.
24430	222.25	260.35	17.46	—	I5B.	11199	230.00	269.00	33.00	—	I5JM	24510	239.71	269.88	19.05	—	I5B.
24431	222.25	263.53	19.05	—	I5B.	14654	230.00	270.00	15.00	—	I5B.	24511	239.71	292.10	25.40	—	I5B.
24432	222.25	266.70	19.05	—	I5B.	14654	230.00	270.00	15.00	—	I5BB	16624	240.00	263.00	12.00	—	I5JM
24433	222.25	273.05	19.05	—	I5B.	11086	230.00	270.00	16.00	—	I5BB	24512	240.00	264.00	14.00	—	I2BB
24434	222.25	273.05	25.40	—	I5B.	24469	230.00	270.00	16.00	—	I5BB	24513	240.00	270.00	12.00	—	I2B.
12794	222.30	273.10	15.88	—	I5B.	11086	230.00	270.00	16.00	—	I2BB	13798	240.00	270.00	15.00	—	I5BA
11954	223.80	250.82	15.08	—	I2BB	13135	230.00	280.00	15.00	—	I5B.	24515	240.00	270.00	15.00	—	I5BB
24435	224.63	250.83	15.08	—	I5B.	24470	230.00	280.00	16.00	—	I5B.	13798	240.00	270.00	15.00	—	I5B.
14653	225.00	250.00	12.00	—	I5B.	13136	230.00	280.00	25.00	—	I5B.	14655	240.00	270.00	16.00	—	I5BB
22614	225.00	250.00	13.00	—	I5B.	24471	230.00	285.00	23.00	—	I5B.	14655	240.00	270.00	16.00	—	I5B.
13551	225.00	250.00	16.00	—	I5B.	24472	230.00	285.00	25.00	—	I2B.	24517	240.00	270.00	16.00	—	I5B.
11947	225.00	250.00	16.00	—	I5B.	14789	230.00	300.00	15.00	—	I5B.	24518	240.00	270.00	16.00	—	I2BB
24437	225.00	270.00	15.00	—	I5B.	24473	230.20	254.00	25.40	—	I5B.	24519	240.00	270.00	18.00	—	I2BB
24438	225.00	270.00	16.00	—	I5B.	11250	231.77	263.53	15.88	—	I2BB	24520	240.00	270.00	19.00	—	I2BA
11417	225.00	271.40	17.80	—	I5JM	13785	231.77	290.00	15.00	—	I5B.	20040	240.00	270.00	20.00	—	I5BB
24439	225.00	280.00	15.00	—	I5BA	24474	231.78	263.53	15.88	—	I2B.	16548	240.00	275.00	16.00	—	I5BB
13854	225.35	266.07	15.87	—	I5JL	24475	231.78	266.70	17.46	—	I5B.	12460	240.00	279.00	22.00	—	I5B.
11298	225.40	257.18	19.05	—	I5B.	24476	231.78	269.88	19.05	—	I5B.	16154	240.00	280.00	15.00	—	I2BB



# Retentores

Perfis - Ver Última Página



INCOVE VEDAÇÕES LTDA.

Cod.	Di	De	Ha1	Ha2	Mod	Cod.	Di	De	Ha1	Ha2	Mod	Cod.	Di	De	Ha1	Ha2	Mod
13760	240.00	280.00	15.00	—	I5B.	24555	250.83	288.93	19.05	—	I5B.	11116	263.50	317.50	25.40	—	I2B.
16154	240.00	280.00	15.00	—	I2BB	24556	250.83	292.10	19.05	—	I5B.	24598	263.53	295.28	22.23	—	I5B.
13760	240.00	280.00	15.00	—	I5BB	24557	250.83	304.83	25.40	—	I5B.	24599	263.53	309.56	25.40	—	I5B.
12788	240.00	280.00	16.00	—	I5JL	11117	251.00	287.00	15.50	—	I2BB	24600	263.53	317.50	25.40	—	I5B.
16147	240.00	280.00	19.00	—	I4BB	24558	252.41	304.80	15.88	—	I2BB	24602	265.00	290.00	16.00	—	I5B.
20245	240.00	280.00	19.00	—	I2BA	24559	252.41	307.98	25.40	—	I5B.	24601	265.00	290.00	16.00	—	I2B.
11589	240.00	280.00	20.00	—	I5JM	14053	254.00	279.40	9.53	—	I5BB	14659	265.00	300.00	16.00	—	I5B.
22578	240.00	280.00	20.00	—	I5B.	24560	254.00	279.40	12.70	—	I5BB	24603	265.00	301.00	18.00	—	I5B.
16015	240.00	288.00	16.00	—	I5JM	24561	254.00	279.40	14.29	—	I5B.	24604	265.00	310.00	16.00	—	I5B.
24521	240.00	290.00	16.00	—	I5B.	24562	254.00	279.40	15.88	—	I5B.	24605	266.70	298.45	15.88	—	I5BA
12998	240.00	300.00	25.00	—	I5BA	22495	254.00	279.40	19.60	—	I5BA	24606	266.70	298.45	17.46	—	I5B.
11849	241.00	273.05	15.88	—	I5B.	16817	254.00	279.50	16.00	—	I5B.	24607	266.70	304.80	15.88	—	I5BB
11314	241.30	266.70	11.11	—	I5B.	24563	254.00	282.58	14.29	—	I5B.	24608	266.70	304.80	15.88	—	I2BB
19420	241.30	266.70	15.87	—	I5B.	24564	254.00	284.75	14.29	—	I5B.	24609	266.70	304.80	15.88	—	I2BB
24522	241.30	266.70	19.05	—	I5B.	24565	254.00	285.75	15.88	—	I5B.	19456	266.70	304.80	17.46	—	I5BB
24523	241.30	269.88	15.88	—	I5B.	24566	254.00	285.75	15.88	—	I2BB	24610	266.70	304.80	17.46	—	I5B.
24524	241.30	273.05	15.88	—	I5B.	24567	254.00	288.00	17.00	—	I5BB	17998	266.70	304.80	19.05	—	I5BB
24525	241.30	276.23	19.05	—	I5B.	24568	254.00	288.93	14.29	—	I5B.	11481	266.70	307.97	19.05	—	I5JL
19423	241.30	279.40	15.87	—	I5B.	24569	254.00	292.10	14.29	—	I5B.	24611	266.70	307.98	19.05	—	I5B.
24526	241.30	279.40	15.88	—	I5B.	11426	254.00	292.35	17.46	—	I5B.	24612	266.70	311.15	19.05	—	I5B.
24527	241.30	282.58	19.05	—	I5B.	24570	254.00	295.28	14.29	—	I5B.	25380	266.70	311.15	25.40	—	I5JL
24528	241.30	285.75	15.88	—	I5B.	24571	254.00	298.45	14.29	—	I5BB	24613	266.70	314.33	19.05	—	I5B.
24529	241.30	288.93	15.88	—	I5B.	24572	254.00	301.63	14.29	—	I5BB	16763	266.70	317.50	15.87	—	I5B.
24530	241.30	292.10	15.88	—	I5B.	16718	254.00	304.80	15.87	—	I2BA	24614	266.70	317.50	19.05	—	I5B.
24531	241.30	292.10	19.05	—	I5BB	16781	254.00	304.80	15.88	—	I5BA	24615	266.70	317.50	25.40	—	I5B.
24532	241.30	292.10	19.84	—	I5B.	16718	254.00	304.80	15.88	—	I2BA	18858	266.70	317.75	25.40	—	I5C
24533	241.30	292.10	25.40	—	I5B.	24573	254.00	304.80	17.46	—	I5B.	11621	266.70	317.75	25.40	—	I5JM
24534	241.50	266.50	12.50	—	I5B.	24574	254.00	304.80	25.40	—	I5B.	18858	266.70	317.75	25.40	—	I5B.
24535	244.48	276.23	19.05	—	I5B.	16718	254.00	305.00	15.87	—	I2B.	24616	266.70	320.68	25.40	—	I5B.
24536	244.48	295.28	25.40	—	I5B.	16739	254.00	305.00	22.50	—	I5B.	12680	267.00	299.00	16.00	—	I5JM
24537	244.48	301.63	15.88	—	I5BB	24575	254.00	311.15	19.05	—	I5B.	11054	268.00	298.00	20.00	—	I5BB
11201	245.00	260.00	15.00	—	I5BB	14801	255.00	285.00	15.00	—	I5B.	24617	268.00	300.00	16.00	—	I5B.
14813	245.00	270.00	16.00	—	I5B.	14657	255.00	290.00	16.00	—	I5B.	24618	269.88	307.98	19.05	—	I5B.
24539	246.06	323.85	31.75	—	I2B.	24576	255.00	315.00	28.00	—	I2B.	24619	269.88	311.15	19.05	—	I5B.
19428	247.65	273.05	15.88	—	I5B.	24577	257.18	295.28	17.46	—	I5B.	24620	269.88	314.33	19.05	—	I5B.
24541	247.65	276.23	15.88	—	I5B.	24578	257.18	298.45	19.05	—	I5B.	24621	269.88	317.50	19.05	—	I5B.
24542	247.65	279.40	19.05	—	I5B.	24579	257.18	301.63	19.05	—	I5B.	13718	269.90	298.50	15.87	—	I5JL
24544	247.65	282.58	19.05	—	I5B.	24580	257.18	304.80	19.05	—	I5B.	16753	270.00	299.00	14.60	—	I5JL
24545	247.65	285.75	19.05	—	I5B.	24581	258.76	311.15	25.40	—	I5B.	14820	270.00	300.00	15.00	—	I5B.
24546	247.65	288.93	19.05	—	I5B.	24582	260.00	258.00	12.00	—	I5BB	24622	270.00	300.00	15.00	—	I5BB
24547	247.65	292.10	19.05	—	I5B.	24583	260.00	258.00	16.00	—	I5B.	13674	270.00	302.00	16.00	—	I5JM
24548	247.65	295.28	19.05	—	I5B.	11090	260.00	280.00	16.00	—	I5JL	16946	270.00	310.00	16.00	—	I5JM
20046	247.65	298.45	19.05	—	I5JM	14658	260.00	290.00	15.00	—	I5B.	24623	270.00	310.00	16.00	—	I5B.
24549	247.65	298.45	25.40	—	I5B.	24584	260.00	290.00	15.00	—	I2BA	24624	270.00	310.00	16.00	—	I2BA
16183	247.65	305.60	38.10	—	I7JL	24585	260.00	290.00	16.00	—	I5B.	16946	270.00	310.00	16.00	—	I2B.
18852	247.70	285.80	19.05	—	I5B.	11384	260.00	298.10	15.87	—	I5JM	16348	271.00	311.50	14.00	—	I5B.
13756	247.70	304.80	38.10	—	I7C	24586	260.00	300.00	14.00	—	I5B.	24625	273.05	268.45	14.29	—	I5B.
14656	250.00	280.00	15.00	—	I5BB	12423	260.00	300.00	20.00	—	I5BA	24626	273.05	301.63	14.29	—	I5B.
24551	250.00	280.00	15.00	—	I5B.	24587	260.00	300.00	20.00	—	I2B.	24627	273.05	304.80	15.88	—	I5B.
24550	250.00	280.00	15.00	—	I2BB	11948	260.00	300.00	20.00	—	I5BB	24628	273.05	307.98	14.29	—	I5B.
14656	250.00	280.00	15.00	—	I5BB	11948	260.00	300.00	20.00	—	I5BB	19467	273.05	311.15	14.29	—	I5B.
14656	250.00	280.00	16.00	—	I5B.	16046	260.00	304.00	20.00	—	I5BB	24629	273.05	311.15	19.84	—	I5B.
16235	250.00	280.00	18.80	—	I5B.	24588	260.00	310.00	16.00	—	I5B.	24630	273.05	314.33	14.29	—	I5B.
25376	250.00	281.00	14.00	—	I5BA	11536	260.00	310.00	16.00	—	I2B.	24632	273.05	317.50	14.29	—	I2BB
24552	250.00	285.00	13.00	—	I5B.	24589	260.00	310.00	25.00	—	I2BB	24631	273.05	317.50	14.29	—	I5B.
11897	250.00	285.00	16.00	—	I5JM	16994	260.00	340.00	20.00	—	I5BB	22554	273.05	317.50	19.05	—	I5C
11680	250.00	285.00	18.00	—	I5BA	24590	260.35	285.75	14.29	—	I5BA	25307	273.05	319.98	21.00	—	I2BB
11330	250.00	290.00	15.00	—	I5B.	22447	260.35	285.75	14.29	—	I5B.	11961	273.05	319.98	25.40	—	I2BB
11545	250.00	290.00	16.00	—	I5B.	16825	260.35	298.40	19.05	—	I5B.	24633	273.05	320.68	14.29	—	I5B.
24553	250.00	290.00	16.00	—	I2B.	24591	260.35	298.45	17.46	—	I5BB	24634	273.05	323.85	25.40	—	I5B.
12529	250.00	290.00	17.00	—	I5JM	11710	260.35	298.45	17.46	—	I5B.	15923	273.05	344.49	20.64	—	I5B.
12529	250.00	290.00	17.00	—	I2JM	24592	260.35	301.63	19.05	—	I5B.	24635	275.00	300.00	15.00	—	I5B.
16213	250.00	290.00	17.00	—	I7JL	19452	260.35	304.80	19.05	—	I5B.	12945	275.00	307.00	25.00	—	I5B.
13682	250.00	292.00	19.00	—	I5B.	24594	260.35	307.98	19.05	—	I5B.	24637	275.00	310.00	16.00	—	I5BB
20366	250.00	296.00	17.40	—	I5B.	24595	260.35	311.15	17.46	—	I5B.	24638	276.23	314.33	19.05	—	I5B.
16453	250.00	300.00	43.50	—	TDUO	24596	260.35	311.15	19.05	—	I2B.	24639	276.23	317.50	19.05	—	I5B.
24554	250.00	310.00	25.00	—	I5B.	24597	260.35	311.15	25.40	—	I5B.	24640	276.40	330.20	15.88	—	I2BA



# Retentores

Perfis - Ver Última Página



INCOVE VEDAÇÕES LTDA.

Cod.	Di	De	Ha1	Ha2	Mod	Cod.	Di	De	Ha1	Ha2	Mod	Cod.	Di	De	Ha1	Ha2	Mod
24641	276.40	330.20	20.64	—	15BA	24690	292.10	336.55	19.05	—	15B.	16948	317.50	355.60	19.05	—	15JL
16216	278.00	326.00	17.00	—	15JL	24691	292.10	339.73	19.05	—	15B.	24741	317.50	361.95	19.05	—	15B.
19473	279.40	304.80	15.88	—	15B.	12464	292.10	342.90	19.05	—	15JM	17905	317.50	368.30	20.64	—	15JM
24643	279.40	307.98	15.88	—	15B.	24692	292.10	342.90	19.05	—	15B.	18837	317.50	368.30	25.40	—	15JL
24644	279.40	311.15	15.88	—	15B.	24693	292.10	342.90	22.23	—	15BB	24742	317.50	371.48	25.40	—	15B.
24645	279.40	314.33	15.88	—	15B.	24694	292.10	352.43	25.40	—	15B.	24743	317.50	374.65	25.40	—	15B.
13842	279.40	315.91	20.64	—	17B.	16017	292.40	342.90	20.50	—	15BB	14788	320.00	350.00	16.00	—	15B.
24646	279.40	317.50	15.88	—	15B.	16582	296.90	328.60	15.87	—	15JM	24744	320.00	350.00	18.00	—	15B.
11606	279.40	317.50	19.05	—	15JL	19499	298.45	336.55	17.46	—	15B.	24745	320.00	355.00	16.00	—	15BA
22439	279.40	330.20	15.88	—	12BA	24695	298.45	336.55	22.23	—	15B.	13941	320.00	360.00	18.00	—	15B
22439	279.40	330.20	15.88	—	12B	24696	298.45	349.25	25.40	—	15B.	24746	320.00	360.00	18.00	—	15BB
13466	279.40	330.20	15.88	—	15B.	24697	298.45	352.43	25.40	—	15B.	12743	320.00	360.00	18.30	—	15JL
24647	279.40	330.20	25.40	—	15B.	24698	298.45	355.60	25.40	—	15B.	24747	320.00	360.00	20.00	—	15B.
24648	279.40	336.55	25.40	—	15B.	13024	300.00	330.00	15.00	—	15B.	16943	320.00	360.00	20.00	—	12B.
24649	279.40	339.73	25.40	—	15B.	24700	300.00	330.00	15.00	—	15BB	24748	320.00	370.00	25.00	—	12BB
24650	279.40	342.90	19.05	—	15B.	24701	300.00	332.00	16.00	—	15B.	24749	320.68	358.78	19.05	—	15B.
24651	279.40	342.90	25.40	—	15B.	24702	300.00	335.00	18.00	—	15B.	24750	320.68	361.05	19.05	—	15B.
14722	280.00	307.00	12.00	—	15B.	24703	300.00	340.00	16.00	—	15BB	24751	320.68	371.48	19.05	—	15B.
14199	280.00	310.00	15.00	—	15BB	24704	300.00	340.00	18.00	—	15B.	24752	320.68	374.65	25.40	—	15B.
14199	280.00	310.00	16.00	—	15B	24705	300.00	340.00	20.00	—	15B.	24753	320.68	388.30	19.05	—	15B.
24652	280.00	310.00	16.00	—	15B.	11533	300.00	340.00	20.00	—	12BA	24754	323.85	361.95	17.46	—	15B.
11345	280.00	316.00	21.00	—	15BB	16820	300.00	340.00	25.00	—	15BB	24755	323.85	377.83	25.40	—	15B.
12633	280.00	320.00	17.00	—	15BA	16101	300.00	345.00	22.00	—	15JL	24756	323.85	381.00	25.40	—	15B.
12422	280.00	320.00	20.00	—	15B.	24706	300.00	350.00	20.00	—	15B.	24757	323.85	400.05	25.40	—	15B.
24653	280.00	320.00	20.00	—	15BA	24707	300.00	360.00	25.00	—	12BA	24758	325.00	365.00	16.00	—	15B.
24654	280.00	320.00	20.00	—	12B.	24708	301.63	336.55	25.40	—	15B.	16822	325.00	370.00	19.00	—	15B.
24655	280.00	324.00	20.00	—	12BB	20021	304.00	330.00	12.00	—	14B.	16685	327.00	346.00	14.29	—	15B.
12890	280.00	330.00	25.00	—	15B.	24710	304.80	336.55	25.40	—	15B.	24759	327.03	346.08	14.29	—	15B.
24656	280.00	330.00	25.00	—	12B.	24711	304.80	342.90	17.46	—	15B.	24760	327.03	374.65	25.40	—	15B.
12890	280.00	330.00	25.00	—	15	24712	304.80	342.90	19.05	—	15B.	24761	330.00	360.00	15.00	—	15B.
24657	280.00	340.00	25.00	—	12BA	24713	304.80	342.90	19.05	—	12BB	16111	330.00	370.00	18.00	—	15B
24658	280.99	320.68	19.05	—	15B.	19504	304.80	343.10	19.00	—	15B.	16305	330.00	370.00	18.00	—	15B.
24659	280.99	323.85	19.05	—	15B.	24714	304.80	344.49	9.92	—	15B.	16111	330.00	370.00	18.00	—	15B.
24660	280.99	327.03	19.05	—	15B.	24715	304.80	344.94	11.11	—	12BA	11383	330.00	370.00	20.00	—	15JM
24661	280.99	330.20	15.88	—	12BA	24716	304.80	346.08	19.05	—	15B.	24762	330.20	368.30	19.05	—	15B.
24662	282.58	320.68	19.05	—	15B.	24718	304.80	349.25	19.05	—	15B.	24763	330.20	371.48	19.05	—	15B.
24663	282.58	323.85	19.05	—	15B.	24719	304.80	352.43	19.05	—	15B.	24764	330.20	374.65	19.05	—	15B.
24664	282.58	327.03	19.05	—	15B.	11616	304.80	355.55	19.05	—	15JM	19532	330.20	377.83	19.05	—	15B.
24665	282.58	342.90	19.05	—	15B.	24720	304.80	355.60	17.46	—	15BA	24766	330.20	381.00	23.81	—	15BB
24666	285.00	310.00	12.70	—	15B.	24721	304.80	355.60	20.64	—	15B.	24767	330.20	381.00	25.40	—	15B.
14792	285.00	310.00	15.00	—	15B.	24722	304.80	355.60	25.40	—	15B.	24769	333.00	368.30	17.46	—	15B.
24668	285.00	310.00	16.00	—	15B.	24723	304.80	361.95	25.40	—	15B.	16629	333.37	374.65	25.40	—	15BB
24667	285.00	310.00	16.00	—	12BB	24724	304.80	368.30	25.40	—	15B.	24770	333.38	384.18	25.40	—	15B.
24669	285.00	325.00	16.00	—	15BB	24725	304.80	374.65	25.40	—	15B.	24771	335.00	370.00	18.00	—	15BB
11688	285.75	323.85	17.46	—	15JM	13672	305.00	343.00	19.00	—	15JM	24774	335.00	375.00	18.00	—	15BB
24670	285.75	323.85	17.46	—	15B.	24726	306.00	320.00	13.00	—	15BB	20062	335.00	482.00	46.00	—	ESPE
22523	285.75	323.85	19.05	—	15B.	24727	307.98	355.60	25.40	—	15B.	24775	336.55	374.65	17.46	—	15B.
24672	285.75	330.20	17.46	—	15BA	24728	310.00	307.00	25.00	—	15BA	24776	336.55	377.83	19.05	—	15B.
24673	285.75	336.55	20.64	—	15B.	24729	310.00	340.00	15.00	—	15B.	24777	336.55	381.00	19.05	—	15B.
24674	285.75	336.55	25.40	—	15BB	24730	310.00	345.00	19.00	—	15B.	24778	336.55	384.18	19.05	—	15B.
24675	285.75	342.90	25.40	—	15B.	11479	310.00	350.00	18.00	—	15B.	19537	336.55	387.35	19.05	—	15JM
24676	287.34	339.73	25.40	—	15B.	19518	311.15	349.20	19.00	—	15JM	24779	336.55	387.35	19.05	—	15B.
11857	287.34	355.66	25.46	—	15BA	19512	311.15	349.20	19.00	—	15B.	16180	336.55	387.35	20.60	—	15JM
24677	288.93	327.03	19.05	—	15B.	19512	311.15	349.20	19.05	—	15JM	24780	336.55	390.53	19.05	—	15B.
24678	288.93	330.20	19.05	—	15B.	24731	311.15	349.25	19.05	—	15B.	24781	336.55	392.11	19.05	—	15B.
24679	288.93	339.73	20.64	—	15B.	24732	311.15	349.25	19.05	—	12BB	24783	336.55	393.70	19.05	—	15B.
24680	288.93	342.90	25.40	—	15B.	24733	311.15	361.95	20.64	—	15B.	24785	336.55	396.88	19.05	—	15B.
24681	290.00	330.00	18.00	—	15BB	24734	314.33	352.43	17.46	—	15B.	24786	336.55	400.05	19.05	—	15B.
14660	290.00	330.00	18.00	—	15B.	24735	314.33	368.30	25.40	—	15B.	24787	336.55	406.40	19.05	—	15B.
24682	290.00	332.00	16.00	—	15B.	24736	314.35	552.45	19.05	—	15B.	24788	339.73	381.00	19.05	—	15B.
24683	290.00	334.00	20.00	—	15BB	25350	315.00	355.00	18.00	—	15B.	24789	339.73	390.53	25.40	—	15B.
24684	290.51	330.20	17.46	—	15B.	24737	315.00	365.00	20.00	—	15B.	24790	340.00	370.00	15.00	—	15BB
24686	292.10	317.50	12.70	—	12BB	24738	315.00	370.00	20.00	—	15BB	13882	340.00	372.00	16.00	—	15B.
24685	292.10	317.50	12.70	—	15B.	13808	316.00	355.50	16.00	—	15JL	13882	340.00	372.00	16.00	—	15BB
24687	292.10	330.20	17.46	—	15B.	24739	317.50	349.25	19.45	—	15B.	24792	340.00	372.00	16.00	—	15B.
24688	292.10	330.20	19.05	—	15B.	24740	317.50	355.60	17.46	—	15B.	24793	340.00	375.00	16.00	—	15BB
24689	292.10	330.20	19.05	—	12BA	16948	317.50	355.60	19.00	—	15JM	24794	340.00	375.00	18.00	—	15B.





# Retentores

Perfis - Ver Última Página



INCOVE VEDAÇÕES LTDA.

Cod.	Di	De	Ha1	Ha2	Mod	Cod.	Di	De	Ha1	Ha2	Mod	Cod.	Di	De	Ha1	Ha2	Mod
24795	340.00	380.00	18.00	---	15BB	24846	374.65	412.75	19.05	---	15B.	16838	406.40	457.00	46.00	---	17BB
24796	340.00	380.00	20.00	---	15B.	24847	374.65	419.10	19.05	---	15B.	16950	406.40	457.20	19.05	---	15JM
11346	340.00	380.00	20.00	---	12B.	11739	375.00	419.00	20.00	---	15JL	24890	406.40	457.20	23.02	---	15BB
24797	340.00	400.00	28.00	---	12BA	24848	375.00	420.00	18.00	---	15B.	18881	406.40	457.20	25.40	---	15B.
24798	342.00	393.70	20.64	---	12BB	24849	377.83	428.63	25.40	---	15B.	24891	406.40	457.20	25.40	---	15B.
24799	342.90	381.00	19.05	---	15BB	24850	380.00	412.00	16.00	---	15B.	18882	406.40	469.90	31.75	---	15B.
24800	342.90	381.00	19.05	---	15BA	20020	380.00	420.00	18.00	---	15JM	11171	410.00	450.00	16.00	---	15JL
24801	342.90	384.18	19.05	---	15B.	16933	380.00	420.00	18.00	---	15BB	24892	412.75	450.85	19.05	---	15B.
19546	342.90	387.35	19.05	---	15B.	16933	380.00	420.00	20.00	---	15BB	24893	412.75	454.03	19.05	---	15B.
24802	342.90	390.53	19.05	---	15B.	16933	380.00	420.00	20.00	---	15BA	24894	412.75	457.20	19.05	---	15B.
24803	342.90	392.11	19.05	---	15B.	24851	380.00	420.00	20.00	---	15B.	11976	415.92	446.10	25.40	---	15B.
24804	342.90	393.70	19.05	---	15B.	11390	380.00	424.20	20.00	---	15JM	16025	415.92	466.72	25.40	---	15B.
24805	342.90	393.70	20.64	---	15B.	24852	380.00	430.00	19.00	---	15B.	16025	415.92	466.72	25.40	---	15B.
24806	342.90	393.70	20.64	---	12BB	11552	380.00	430.00	22.00	---	15JL	24895	419.10	457.20	19.05	---	15B.
18870	343.00	381.20	19.00	---	15B.	12943	380.00	440.00	25.00	---	15BA	24896	419.10	469.90	25.40	---	15B.
16462	345.00	395.00	17.00	---	15B.	12943	380.00	440.00	25.00	---	15BB	24897	419.10	482.60	19.05	---	15B.
24807	346.08	393.70	25.00	---	15B.	12193	381.00	419.00	19.00	---	15JM	16227	419.10	482.60	25.40	---	15C
24808	349.25	387.35	19.05	---	15B.	24853	381.00	419.10	19.05	---	15B.	24898	420.00	460.00	20.00	---	15B.
24809	349.25	387.35	19.05	---	12B.	24855	381.00	425.45	19.05	---	15B.	24899	420.00	470.00	20.00	---	15BB
24810	349.25	393.70	19.05	---	15B.	24856	381.00	428.63	19.05	---	15B.	12492	425.00	475.00	22.00	---	15BB
16814	349.25	393.70	19.05	---	15B.	16702	381.00	431.80	19.05	---	15B.	24901	425.00	480.00	19.00	---	15BA
24811	349.25	393.70	19.05	---	12B.	16702	381.00	431.80	19.05	---	15B.	24902	425.45	476.25	25.40	---	15B.
24812	349.25	395.29	25.40	---	15B.	24857	381.00	431.80	19.05	---	15B.	24903	425.45	482.60	22.23	---	15B.
24813	349.25	400.05	25.40	---	15B.	24858	381.00	431.80	31.75	---	12B.	24904	430.00	470.00	16.00	---	15BB
24814	349.25	406.40	25.40	---	15B.	24859	381.00	438.15	19.05	---	15B.	24905	430.00	480.00	22.00	---	15BB
14910	350.00	380.00	16.00	---	15B.	24860	381.00	444.50	25.40	---	15B.	24907	431.80	469.90	19.05	---	15BB
24815	350.00	380.00	16.00	---	15BA	12171	387.35	422.28	13.49	---	15JL	12695	431.80	470.15	17.46	---	15B.
16949	350.00	390.00	16.00	---	15JL	12771	387.35	425.45	19.05	---	12BB	24908	431.80	482.60	20.64	---	15B.
14790	350.00	390.00	18.00	---	15B.	24861	387.35	425.45	19.05	---	12B.	24909	431.80	482.60	23.42	---	15B.
24816	350.00	390.00	18.00	---	15BB	24862	387.35	428.63	19.05	---	15B.	24910	431.80	482.60	23.42	---	15B.
16469	350.00	390.00	18.00	---	12BB	24863	387.35	438.15	19.05	---	15B.	24911	431.80	490.14	30.16	---	15B.
16932	350.00	390.00	20.00	---	15BB	24864	390.00	430.00	18.00	---	15B.	24912	431.80	490.14	30.16	---	15B.
12465	350.00	400.00	25.00	---	15B.	16327	390.00	434.00	20.00	---	12JM	24913	432.00	485.00	25.00	---	15B.
24817	352.43	390.53	19.05	---	15BB	24865	390.53	428.63	19.05	---	15B.	24914	433.39	482.60	23.42	---	15BB
24818	352.43	400.05	25.40	---	15B.	24866	390.53	441.33	19.05	---	15B.	24915	435.00	465.00	18.00	---	15B.
24819	352.43	406.40	21.03	---	15BB	24867	390.53	450.06	30.16	---	15B.	24916	438.15	488.95	20.64	---	15B.
24820	354.01	392.11	19.05	---	15B.	24868	391.32	457.50	19.05	---	15B.	24917	440.00	470.00	20.00	---	15B.
24821	355.60	393.70	19.05	---	15B.	24869	392.91	438.15	22.23	---	15BB	25461	440.00	480.00	20.00	---	12B.
24822	355.60	396.88	19.05	---	15B.	24870	392.91	444.50	25.40	---	15B.	16937	440.00	480.00	20.00	---	15B.
24823	355.60	400.05	19.05	---	15B.	18880	393.60	444.50	25.40	---	15BB	16937	440.40	480.00	20.00	---	15JL
11978	355.60	400.05	19.05	---	12BB	19578	393.70	431.80	19.05	---	15B.	11309	441.10	459.30	20.63	---	12BB
24824	355.60	412.75	25.42	---	15B.	24871	393.70	444.50	20.64	---	15BB	24918	444.50	482.60	17.46	---	15B.
24825	355.60	419.10	25.40	---	15B.	24872	393.70	444.50	25.40	---	15B.	24919	444.50	482.60	19.05	---	15B.
19558	358.78	412.75	25.40	---	15B.	24873	393.70	450.85	25.40	---	15B.	24920	444.50	488.95	19.05	---	15B.
24827	358.78	419.10	25.40	---	15B.	24874	393.70	457.20	25.40	---	15B.	24921	444.50	495.30	20.64	---	15B.
24828	358.78	425.45	25.40	---	15B.	13881	394.00	420.00	16.00	---	15BB	19606	447.68	488.95	17.46	---	15B.
24829	360.00	392.00	20.00	---	15B.	24876	395.00	430.00	18.00	---	15B.	11122	450.00	500.00	22.00	---	15JM
24830	360.00	400.00	18.00	---	15B.	11930	396.87	450.85	25.40	---	12BB	12786	450.00	500.00	26.00	---	15JM
---	360.00	400.00	20.00	---	15BA	24877	396.88	444.50	21.43	---	15B.	24922	450.85	501.65	20.64	---	15B.
24832	360.36	393.70	15.88	---	15BB	24878	396.88	454.03	25.40	---	15B.	24923	450.85	510.38	25.40	---	15B.
24833	361.95	412.75	25.40	---	15B.	24879	398.00	450.00	18.00	---	15BA	24924	454.03	504.83	20.64	---	15B.
24834	365.00	405.00	18.00	---	15B.	16834	400.00	438.00	35.70	---	17BB	24925	454.03	508.00	19.05	---	15B.
11478	366.00	404.70	12.70	---	15JM	24880	400.00	440.00	20.00	---	15BA	24926	457.20	495.30	19.05	---	15BB
11478	366.00	404.70	12.70	---	15JL	12614	400.00	460.00	25.00	---	15BA	24927	457.20	501.65	19.05	---	15B.
18878	368.20	419.10	25.40	---	12BA	19585	400.05	438.15	17.46	---	15BA	24928	457.20	504.83	19.05	---	15B.
24835	368.30	406.40	25.40	---	15B.	12815	400.05	450.85	17.46	---	15B.	24929	457.20	508.00	22.23	---	15B.
24836	368.30	412.75	19.05	---	15B.	19586	400.05	450.85	25.40	---	15BB	24930	457.20	508.00	25.40	---	15BB
24837	368.30	419.10	19.05	---	15B.	24882	400.05	454.03	25.40	---	15B.	13931	458.00	495.00	19.50	---	15JM
24838	368.30	419.10	25.40	---	12B.	24883	400.05	457.20	25.40	---	15B.	24931	460.00	500.00	20.00	---	15BA
24839	368.30	425.45	19.05	---	15B.	24884	400.05	463.55	25.45	---	15B.	12689	460.00	515.00	28.00	---	15JM
24840	369.88	447.68	25.40	---	15B.	24885	400.05	469.90	25.40	---	15B.	12512	460.00	520.00	25.00	---	15JM
24841	369.88	450.06	25.40	---	15B.	24886	403.23	454.03	20.64	---	15B.	24932	463.55	501.65	19.05	---	15B.
24842	369.88	450.85	25.40	---	15B.	14902	405.00	430.00	16.00	---	15B.	24933	463.55	504.83	19.05	---	15B.
24843	370.00	410.00	21.00	---	15B.	13915	406.00	440.00	19.05	---	15JM	24934	466.73	504.83	19.05	---	15B.
11846	370.00	420.00	14.00	---	14	24887	406.40	444.50	19.05	---	15BB	24935	466.73	508.00	19.05	---	15B.
24844	371.48	425.50	25.40	---	15B.	24888	406.40	444.50	20.64	---	15B.	24936	466.73	517.53	25.40	---	15B.
24845	374.65	412.75	17.46	---	12B.	24889	406.40	447.68	19.05	---	15B.	24937	466.73	520.70	25.40	---	15B.





# Retentores

Perfis - Ver Última Página



INCOVE VEDAÇÕES LTDA.

Cod.	Di	De	Ha1	Ha2	Mod	Cod.	Di	De	Ha1	Ha2	Mod	Cod.	Di	De	Ha1	Ha2	Mod
24938	467.00	510.00	20.00	—	15B.	24995	549.28	593.73	22.23	—	15B.	25051	641.35	711.20	25.40	—	15B.
14796	468.00	489.50	14.00	—	15B.	24996	549.28	600.08	22.23	—	15B.	25052	641.35	717.55	25.40	—	15B.
24939	469.00	488.95	14.29	—	15B.	16328	550.00	600.00	25.00	—	15JL	25053	641.35	741.38	25.40	—	15B.
24940	469.00	520.70	22.23	—	15B.	24997	552.45	603.25	22.23	—	15B.	25054	647.70	685.80	19.05	—	15B.
24941	469.00	520.70	23.81	—	15B.	24998	552.45	615.95	25.40	—	15B.	25055	647.70	698.50	22.23	—	15B.
19620	469.90	520.90	22.20	—	15B	24999	552.45	690.60	25.40	—	15B.	19717	650.88	711.20	25.40	—	15B.
16187	476.25	514.35	19.05	—	15JM	25000	554.51	588.96	17.46	—	15B.	25057	657.23	711.20	22.23	—	15B.
24942	476.25	514.35	19.05	—	15B.	25001	558.80	596.90	19.05	—	15B.	25058	657.23	717.55	22.23	—	15B.
24943	476.25	527.05	25.40	—	15B.	12549	558.80	603.25	20.62	—	15BB	25059	657.23	723.90	22.23	—	15B.
24945	480.00	520.00	20.00	—	15BB	25002	558.80	609.60	25.40	—	15BA	25060	657.23	730.25	22.23	—	15B.
24944	480.00	520.00	20.00	—	15BA	25003	558.80	609.60	30.16	—	15B.	25061	660.40	711.20	25.40	—	15B.
24946	482.00	520.00	24.00	—	15B.	25004	558.80	615.95	25.40	—	15B.	25062	660.40	714.38	25.40	—	15B.
24947	482.60	520.70	19.05	—	15B.	25005	558.80	622.30	25.40	—	15B.	25063	660.40	717.55	25.40	—	15B.
24948	482.60	533.40	22.23	—	15BB	25006	558.80	628.65	25.40	—	15B.	25064	660.40	736.60	25.40	—	15B.
24949	482.60	533.40	22.23	—	12BB	25007	558.80	635.00	25.40	—	15B.	25065	663.58	701.68	19.05	—	15B.
24950	488.95	539.75	25.40	—	15B.	11910	558.80	729.90	44.50	—	ESPE	25066	663.58	714.38	22.23	—	15B.
24951	492.13	536.58	19.05	—	15B.	16268	559.50	609.60	31.00	—	15BB	25067	669.93	708.03	19.05	—	15B.
12769	493.71	539.75	22.22	—	15B.	25008	560.00	610.00	20.00	—	15BB	25068	669.93	714.38	22.23	—	15B.
24952	495.30	546.10	22.23	—	15B.	25009	565.15	615.95	22.23	—	15B.	25069	673.10	711.20	19.01	—	15B.
24953	495.30	549.28	22.23	—	15B.	25010	569.33	622.30	22.23	—	15B.	25070	673.10	721.12	25.40	—	15BB
24954	495.30	552.45	25.40	—	15B.	25011	569.91	609.60	19.05	—	15BB	25071	673.10	722.31	25.40	—	15BB
24955	495.30	558.80	25.40	—	15B.	25012	569.91	615.95	19.05	—	15B.	25072	685.80	736.60	25.40	—	15B.
24956	495.30	561.98	25.40	—	15B.	25013	569.91	620.71	22.23	—	15B.	25073	685.80	749.30	25.40	—	15B.
24957	495.30	565.15	25.40	—	15B.	11892	571.30	622.30	25.40	—	12	25074	685.80	752.48	25.40	—	15B.
24958	495.30	571.50	25.40	—	15B.	25014	571.50	622.30	25.40	—	15B.	25075	685.80	757.24	25.40	—	15B.
11334	495.30	666.40	44.50	—	ESPE	25015	577.85	628.65	22.23	—	15B.	25076	685.80	762.00	25.40	—	15B.
24959	500.00	540.00	20.00	—	15B.	22477	584.20	615.95	19.05	—	15B.	25077	688.98	736.60	25.40	—	15B.
24960	500.00	550.00	20.00	—	15BB	20111	584.20	628.65	19.05	—	15B.	25078	690.56	742.95	22.23	—	15B.
11553	500.00	550.00	22.00	—	15JL	22476	584.20	635.00	25.40	—	15B.	25079	698.50	759.62	25.40	—	15B.
13564	500.00	550.00	23.00	—	15B.	25016	584.20	641.35	25.40	—	15B.	25080	701.68	749.30	19.05	—	15B.
11402	500.00	550.00	25.40	—	15JM	25017	584.20	644.53	25.40	—	15B.	25081	708.03	757.24	22.23	—	15B.
24961	500.00	560.00	30.00	—	15BA	25018	584.20	647.70	25.40	—	15B.	25082	710.00	760.00	20.00	—	15B.
24962	501.65	546.10	25.40	—	12BB	25019	590.55	641.35	25.40	—	15B.	25083	711.20	762.00	22.23	—	15B.
24963	501.65	552.45	22.23	—	15B.	25020	596.90	647.70	25.40	—	15B.	25084	711.20	774.70	25.40	—	15B.
24964	501.65	558.80	25.40	—	15B.	25021	598.49	641.35	19.05	—	15B.	25085	711.20	787.40	25.40	—	15B.
24965	501.65	561.98	25.40	—	15B.	25022	598.49	644.53	19.05	—	15B.	25086	711.20	794.30	19.05	—	15B.
24966	501.65	565.15	25.40	—	15B.	25023	600.00	640.00	20.00	—	15B.	25087	723.90	774.70	25.40	—	15B.
24967	504.83	558.80	25.40	—	15B.	25024	600.08	660.40	19.05	—	15B.	25088	723.90	778.40	25.40	—	15B.
16441	506.41	549.28	15.88	—	15B.	25025	606.43	660.40	22.23	—	15B.	25089	723.90	800.10	25.40	—	15B.
24968	508.00	536.58	15.88	—	15B.	16506	609.60	660.40	20.64	—	15B.	11910	729.90	558.80	44.50	—	ESPE
24969	508.00	546.10	19.05	—	15B.	25026	609.60	660.40	25.40	—	15B.	25090	736.60	774.70	19.05	—	15B.
24970	508.00	552.45	19.05	—	15B.	25027	609.60	666.75	25.40	—	15B.	25091	736.60	787.40	25.40	—	15B.
24971	508.00	558.80	22.23	—	15B.	25028	609.60	673.10	25.40	—	15B.	25092	736.60	812.80	25.40	—	15B.
24972	508.00	561.98	25.40	—	15B.	25029	609.60	682.63	25.40	—	15B.	25093	739.78	815.98	22.23	—	15B.
24973	514.35	565.15	22.23	—	15B.	25030	609.60	685.80	25.40	—	15B.	25094	749.30	800.01	25.40	—	15B.
24974	514.35	565.15	25.40	—	15B.	25031	609.60	692.15	25.40	—	15B.	25095	749.30	800.89	22.23	—	15B.
24975	514.35	609.60	22.23	—	15B.	25032	609.60	698.50	25.40	—	15B.	25096	749.30	812.80	25.40	—	15B.
24976	519.11	571.50	25.40	—	15B.	25033	615.95	666.75	19.05	—	15B.	25097	749.30	825.50	25.40	—	15B.
24977	519.11	584.20	22.23	—	15B.	12947	620.00	690.00	35.00	—	15BA	25098	752.48	803.28	25.40	—	15B.
24978	519.11	596.60	22.23	—	15B.	25035	620.71	660.40	19.05	—	15B.	25099	752.48	812.80	25.40	—	15B.
24979	519.11	609.60	22.23	—	15B.	25036	620.71	666.75	19.05	—	15B.	25100	752.48	825.50	25.40	—	15B.
24980	519.11	622.30	22.23	—	15B.	25037	620.71	671.51	19.05	—	15B.	25101	752.48	828.68	25.40	—	15B.
24981	520.70	571.50	22.23	—	15BB	25038	622.30	673.10	25.40	—	15B.	25102	752.48	831.85	25.40	—	15B.
24982	520.70	577.85	25.40	—	15B.	25039	622.30	682.63	25.40	—	15B.	25103	760.00	800.00	20.00	—	15B.
24983	526.23	574.68	25.40	—	15B.	25040	622.30	685.80	25.40	—	15B.	25104	762.00	800.10	19.05	—	15B.
24984	527.05	577.85	22.23	—	15B.	25041	622.30	692.15	25.40	—	15B.	25105	762.00	812.80	22.23	—	15BB
24985	530.25	581.03	22.23	—	15B.	25042	622.30	692.15	25.40	—	15B.	25106	762.00	812.80	25.40	—	15B.
24986	530.25	584.20	25.40	—	15B.	25044	622.30	698.15	—	—	15B.	25107	762.00	825.50	25.40	—	15B.
24987	530.25	589.76	23.81	—	15B.	20315	630.00	694.00	25.00	—	15B.	25108	762.00	831.85	22.23	—	15B.
24988	533.40	584.20	22.23	—	15B.	22481	635.00	673.10	22.23	—	15B.	25109	762.00	838.20	22.23	—	15B.
24989	533.40	596.90	25.40	—	15B.	25045	635.00	673.10	22.23	—	15B.	25110	769.94	822.38	22.23	—	15B.
24990	539.75	590.55	22.23	—	15B.	25046	635.00	685.80	25.40	—	15B.	25111	769.94	825.50	25.40	—	15B.
24991	541.34	592.14	25.40	—	15B.	22482	635.00	692.15	25.40	—	15B.	25112	769.94	831.85	25.40	—	15B.
24992	542.93	593.73	25.40	—	15B.	25047	635.00	698.50	25.40	—	15B.	25113	769.94	838.20	25.40	—	15B.
11158	545.00	600.00	25.00	—	15B.	25048	639.76	682.63	19.05	—	15B.	25114	769.94	844.45	25.40	—	15B.
24993	546.10	596.90	22.23	—	15B.	25049	641.35	692.15	25.40	—	15B.	25115	769.94	854.34	25.40	—	15B.
24994	546.10	609.60	25.40	—	15B.	25050	641.35	698.50	25.40	—	15B.	20078	770.00	810.00	29.00	—	ESPE



# Retentores

Perfis - Ver Última Página



INCOVE VEDAÇÕES LTDA.

Cod.	Di	De	Ha1	Ha2	Mod	Cod.	Di	De	Ha1	Ha2	Mod	Cod.	Di	De	Ha1	Ha2	Mod
25116	774.70	825.50	25.40	—	I5B.	25158	860.43	914.40	22.23	—	I5B.	25202	942.98	993.78	15.88	—	I5B.
25117	774.70	831.85	25.40	—	I5B.	25159	860.43	927.10	22.23	—	I5B.	25203	946.15	996.95	22.23	—	I5B.
25118	774.70	838.20	25.40	—	I5B.	25160	860.43	930.28	22.23	—	I5B.	25204	950.91	1003.30	22.23	—	I5B.
25119	774.70	850.90	25.40	—	I5B.	25161	863.60	914.40	22.23	—	I5B.	25205	950.91	1016.00	22.23	—	I5B.
25120	787.00	825.50	19.50	—	I5B.	25162	863.60	927.10	22.23	—	I5B.	25206	950.91	1028.70	22.23	—	I5B.
25121	787.40	838.20	25.40	—	I5B.	25163	863.60	939.80	22.23	—	I5B.	25207	952.51	1003.30	25.40	—	I5B.
25122	787.40	850.90	25.40	—	I5B.	25164	869.95	920.75	22.23	—	I5B.	25208	960.44	1016.00	25.40	—	I5B.
25123	787.40	863.60	25.40	—	I5B.	25165	869.95	927.10	22.23	—	I5B.	25209	960.44	1028.70	25.40	—	I5B.
25124	812.80	863.60	25.40	—	I5B.	25166	869.95	933.45	22.23	—	I5B.	25210	960.44	1035.05	25.40	—	I5B.
25125	812.80	869.95	25.40	—	I5B.	25167	876.30	927.10	22.23	—	I5B.	25211	960.44	1040.61	25.40	—	I5B.
25126	815.98	866.78	22.23	—	I5B.	25168	882.65	933.45	22.23	—	I5B.	25212	965.20	1016.00	22.23	—	I5B.
25127	815.98	879.48	22.23	—	I5B.	25169	882.65	939.80	25.40	—	I5B.	25213	965.20	1028.70	22.23	—	I5B.
25128	820.74	873.13	22.23	—	I5B.	25170	882.65	949.33	25.40	—	I5B.	25214	965.20	1035.05	25.40	—	I5B.
25129	820.74	876.30	22.23	—	I5B.	25171	882.65	952.50	22.23	—	I5B.	25215	965.20	1041.40	25.40	—	I5B.
25130	820.74	889.00	22.23	—	I5B.	25172	882.65	958.85	25.40	—	I5B.	25216	965.20	1047.75	25.40	—	I5B.
25131	820.74	892.18	22.23	—	I5B.	25173	889.00	939.80	25.40	—	I5B.	25217	971.55	1022.35	25.40	—	I5B.
25132	825.50	869.95	23.81	—	I5B.	25174	889.00	949.33	25.40	—	I5B.	25218	971.55	1028.70	25.40	—	I5B.
25133	825.50	876.30	22.23	—	I5B.	25175	889.00	952.50	25.40	—	I5B.	25219	971.55	1035.05	25.40	—	I5B.
25134	831.85	876.30	25.40	—	I5B.	25176	889.00	958.85	25.40	—	I5B.	25220	971.55	1041.40	25.40	—	I5B.
25135	831.85	882.65	25.40	—	I5B.	25177	889.00	965.20	25.40	—	I5B.	25221	971.55	1047.75	25.40	—	I5B.
25136	831.85	889.00	19.05	—	I5B.	25178	895.35	946.15	22.23	—	I5B.	25222	984.25	1041.40	22.23	—	I5B.
25137	831.85	889.00	25.40	—	I5B.	25179	900.00	950.00	25.00	—	I5BA	25223	984.25	1047.75	25.40	—	I5B.
25138	831.85	895.35	25.40	—	I5B.	25180	901.70	952.50	22.23	—	I5B.	25224	984.25	1066.80	25.40	—	I5B.
25139	831.85	901.70	25.40	—	I5B.	25181	901.70	958.85	25.40	—	I5B.	25225	984.25	1073.15	25.40	—	I5B.
25140	831.85	908.05	25.40	—	I5B.	25182	901.70	965.20	25.40	—	I5B.	25226	984.75	1035.05	25.40	—	I5B.
16564	836.00	915.40	22.22	—	I5B.	25183	901.70	971.55	25.40	—	I5B.	25227	989.53	949.33	22.23	—	I5B.
25141	838.20	869.95	19.05	—	I5B.	25184	901.70	977.90	25.40	—	I5B.	25228	990.60	1041.40	25.40	—	I5B.
25142	838.20	889.00	15.88	—	I5B.	25185	911.23	962.03	22.23	—	I5B.	25229	990.60	1047.75	25.40	—	I5B.
25143	838.20	889.00	22.23	—	I5B.	25186	914.40	965.20	25.40	—	I5B.	25230	990.60	1057.10	25.40	—	I5B.
25144	838.20	895.35	25.40	—	I5B.	25187	914.40	971.55	25.40	—	I5B.	25231	990.60	1066.80	25.40	—	I5B.
25145	838.20	901.70	22.23	—	I5BB	25188	914.40	977.90	25.40	—	I5B.	25232	990.60	1073.15	25.40	—	I5B.
25146	838.20	901.70	23.81	—	I5BA	25189	914.40	984.25	25.40	—	I5B.	25233	1016.00	1066.80	22.23	—	I5B.
25147	838.20	904.88	22.23	—	I5B.	25190	914.40	990.60	25.40	—	I5B.	25234	1028.70	1079.50	25.40	—	I5B.
25148	838.20	909.05	25.40	—	I5B.	25191	920.75	971.55	25.40	—	I5B.	25235	1057.28	1117.60	25.40	—	I5B.
25149	838.20	914.40	25.40	—	I5B.	25192	920.75	977.90	25.40	—	I5B.	25236	1062.04	1117.60	25.40	—	I5B.
25150	850.90	901.70	22.23	—	I5B.	25193	920.75	984.25	25.40	—	I5B.	25237	1065.21	1104.90	19.05	—	I5B.
25151	850.90	904.88	25.40	—	I5B.	25194	920.75	990.60	25.40	—	I5B.	16912	1498.60	1549.40	22.50	—	I5BB
25152	850.90	908.05	25.40	—	I5B.	25196	927.10	965.20	19.05	—	I5B.	16334	—	101.60	22.70	—	TDUO
25153	850.90	914.90	25.40	—	I5B.	25197	927.10	977.90	25.40	—	I5B.	17839	—	—	—	—	ESPE
25154	850.90	920.75	25.40	—	I5B.	25198	927.10	984.25	25.40	—	I5B.	—	—	—	—	—	ESPE
25155	850.90	925.51	25.40	—	I5B.	25199	927.10	990.60	25.40	—	I5B.	—	—	—	—	—	ESPE
25156	854.08	904.88	25.40	—	I5B.	25200	933.45	984.25	25.40	—	I5B.	15800	—	—	—	—	NT
25157	860.43	911.23	22.23	—	I5B.	25201	939.80	990.60	25.40	—	I5B.	—	—	—	—	—	ESPE



**INCOVE**<sup>®</sup>

INCOVE VEDAÇÕES LTDA.

**GAxetas**



## GAXETAS

As gaxetas constituem a forma tradicional de vedadores utilizados em selos de alojamento e podem ser fabricadas em uma grande variedade de materiais. Assim, uma gaxeta pode consistir em pedaços de pano de forma irregular, geralmente misturados com um lubrificante, com os quais se enche o alojamento ou a caixa de gaxeta; em cordões (de seção geralmente retangular mas às vezes circular) cortados em pedaços de tamanho adequado, enrolados em espiral; ou em seções confeccionadas especialmente, colocadas no alojamento na forma de anéis cortados. Em todos os casos, a vedação é obtida por meio do aperto da sobreposta (também denominada preme-gaxeta), ou, em alguns casos, pelo uso de uma mola dentro de um espaço não ajustável do alojamento, de modo que a gaxeta seja forçada contra ou comprimida sobre a superfície a ser selada. Deve-se notar que o termo *aperto* é usado num sentido amplo. Algumas gaxetas expandem-se em serviço, em consequência, por exemplo, de um aumento de temperatura, requerendo então um aperto inicial muito pequeno. Em outros casos, pode ser necessário um reaperto periódico da sobreposta para compensar desgaste e relaxamento e manter uma vedação satisfatória.

Outros tipos de vedadores podem ser classificados como gaxetas de compressão quando usados em serviços alternativos ou rotativos. Isso se aplica principalmente aos anéis inteiriços de materiais elásticos ou rígidos. No primeiro caso, a pressão radial necessária para assegurar a vedação é obtida pela compressão do material, produzida pelo aperto da sobreposta. Quanto aos anéis de engaxetamento rígidos, eles geralmente possuem uma forma tal que o aperto da sobreposta provoca uma ação de cunha que os desloca radialmente de modo a se apoiarem na superfície a ser selada.

As gaxetas permanecem como a primeira escolha em muitas aplicações, principalmente aquelas em que se encontram caixas de gaxeta de grandes dimensões e condições severas de serviço, tais como os serviços de vapor e o manuseio de grandes massas de água. As gaxetas de compressão apresentam ainda a vantagem de poderem ser usadas em serviços tanto rotativos como alternativos. Assim, enquanto em muitos serviços

alternativos, principalmente em projetos novos, os vedadores flexíveis, individualmente ou em jogos, podem substituir as gaxetas, já em selos de eixos rotativos as gaxetas continuam a ser o tipo principal de vedador, principalmente em tamanhos grandes e serviços pesados, a menos que se requeira um vazamento mínimo como exigência básica, caso em que pode ser necessário o emprego de um selo mecânico ou de um selo de tipo especial.

A maioria das gaxetas modernas é de seção praticamente quadrada e fabricada com uma grande variedade de materiais. Estes podem abranger desde materiais simples, como amianto ou algodão trançado, até construções mistas com reforço de fios metálicos e uso de borracha como impregnante ou ligante. As gaxetas podem tornar-se autolubrificadas mediante a impregnação de um lubrificante adequado, ou possuir superfícies de apoio de baixo atrito proporcionadas por insertos metálicos de baixo atrito ou envoltórios de metal macio. Os materiais (ou o material) básicos das gaxetas são escolhidos em função do serviço visado, isto é, temperatura e compatibilidade, ao passo que a forma de sua construção determina a capacidade de pressão, a expansão transversal da gaxeta quando comprimida pela sobreposta e o comportamento mecânico em movimentos alternativos ou rotativos. As seções das gaxetas podem ser projetadas especificamente apenas para serviços alternativos, apenas para serviços rotativos ou, simplesmente, para serviços alternativos e rotativos. Algumas seções são também projetadas especificamente para aplicações estáticas.

A maioria das gaxetas é perfeitamente elástica, variando de "mole" ou semiplástica a moderadamente dura, segundo as necessidades do serviço. Existe ainda a classe das gaxetas duras, geralmente providas de uma capa metálica externa, destinadas primordialmente a aplicações rotativas, frequentemente em altas temperaturas. As gaxetas calçadas constituem um grupo intermediário, pois embora elas apresentem uma face dura à superfície deslizante, essa face é apoiada por uma seção elástica que fornece o aperto de calçamento quando comprimida. Os anéis de calço, por outro lado, podem ser fabricados exclusivamente de material duro e ser virtualmente incompressíveis.

As gaxetas soltas encontram uma aplicação especial nas caixas de gaxeta de válvulas e bombas e possuem a



vantagem da grande facilidade de colocação. Para isso, é suficiente aplicar-lhes pequenos golpes que as façam penetrar na caixa de gaxeta; elas se tornam densas e homogêneas com o correr da operação e apresentam alto grau de permeabilidade. Como regra geral, é recomendável usar, com as gaxetas soltas, anéis terminais inteiros ou anéis cindidos de gaxeta maciça, destinados a evitar extrusão da gaxeta solta; isso, contudo, poderá ser desnecessário se a sobreposta e a bucha estiverem em perfeitas condições.

Dado que as gaxetas de compressão requerem uma alta pressão na interface gaxeta/superfície, torna-se desejável o uso de um material de baixo atrito em aplicações dinâmicas, para minimizar a resistência ao movimento e eliminar o desgaste. Nos pontos em que não se possa assegurar a lubrificação da superfície que passa pela face da gaxeta, pode ser possível introduzir um lubrificante na própria gaxeta ou usar uma superfície de baixo atrito na interface.

A grafita é o lubrificante geralmente aplicado às gaxetas, proporcionando excelentes propriedades de autolubrificação para muitos serviços em que, sem isso, as gaxetas trabalhariam a seco ou em contato com um fluido não lubrificante. Assim, a lubrificação pela grafita é especialmente adequada para serviços de vapor e água, e em particular água salgada. Em alguns casos, contudo, a presença de grafita solta pode ser desaconselhável; ou, no caso de gaxetas que trabalham em contato com hastes de aço inoxidável, a grafita pode causar corrosão do aço por ataque eletrolítico. Um lubrificante impregnante alternativo que supera essas dificuldades é a mica.

O teor de lubrificante usado varia com o serviço. Assim, uma gaxeta destinada a movimentos de grande velocidade, principalmente altas velocidades de rotação, deve ser normalmente de um tipo macio para manter flexibilidade por longos períodos e poder conter grande quantidade de lubrificante. Uma gaxeta destinada exclusivamente a aplicações estáticas normalmente não contém lubrificante algum. E se for destinada a serviços alternativos, poderá conter um reforço de arame antifricção de preferência a um lubrificante, possivelmente com uma aplicação final de grafita. Outras poderão conter reforço de arame antifricção de metal macio e ser impregnadas de lubrificante.

O valor desses reforços de arame está no fato de que eles asseguram lubrificação contínua ao eixo e contribuem para remover o calor da superfície de trabalho.

Em alguns casos, os alojamentos de vedação ou caixas de gaxeta podem ser encheidos vantajosamente com gaxetas mistas. Assim, quando o serviço requer o uso de uma gaxeta macia ou semiplástica para vedar um líquido de baixa viscosidade, pode-se empregar uma combinação dessa gaxeta com anéis terminais mais duros para minimizar o perigo de extrusão e apoiar devidamente os anéis macios. Analogamente, podem-se usar alternadamente anéis duros e macios para conferir rigidez a um engaxetamento relativamente mole; ou conferir elasticidade a um engaxetamento basicamente duro (por exemplo, para absorver cargas laterais).

#### Vapor em Alta Temperatura

Para temperaturas entre 290°C e 400°C, serão usados provavelmente fios de amianto trançado com impregnação de grafita. Para temperaturas mais elevadas, é suficiente um reforço de arame de cobre (até 450°C), ou um trançado externo de arame fino de cobre (até 680°C).

#### Vapor em Média e Baixa Temperatura

Nessa faixa podem ser usados tecidos de amianto impermeabilizados, com ou sem uma alma de borracha resistente ao calor.

#### Serviços de Água

Gaxetas de tecido impermeabilizado, gaxetas de fio lubrificado trançado, gaxetas de borracha e gaxetas de couro, são todas adequadas, embora o tipo de construção dependa do uso previsto, se serviços alternativos ou rotativos. As gaxetas de folhas metálicas também são largamente usadas, embora geralmente não sejam adequadas para eixos gastos ou riscados ou eixos de metal macio. As gaxetas de fio de cânhamo lubrificado, bem como as de couro, são bem aceitas em serviços de água. O couro tem a vantagem de permanecer macio e exercer uma suave ação de desgaste sobre os eixos.

#### Salmoura e Amônia

Para esses serviços, são largamente preferidas as gaxetas





de lona de algodão e as gaxetas de borracha de seção definida, lubrificadas com grafita.

## Óleos e Hidrocarbonetos Leves

Os materiais comumente empregados para esses serviços incluem as gaxetas de tecido impermeabilizado, as gaxetas de borracha, os fios de algodão e amianto lubrificadas e trançadas, as gaxetas de amianto e silicone e as gaxetas de folhas metálicas.

## Ácidos e Álcalis

Os materiais específicos para ácidos incluem os fios de amianto azul de alta qualidade com ou sem reforço de arame e lubrificante, PTFE e amianto azul ou branco impregnado de silicone (com limitações).

Para álcalis, os materiais indicados incluem os fios de amianto azul com ou sem reforço e lubrificante, PTFE, amianto e silicone etc.

**Nota: Muitas gaxetas são de construção mista. Assim, pode-se usar um material de engaxetamento relativamente duro com uma alma mole para conferir-lhe resiliência ou um material mais mole pode ser reforçado ou enrijecido com *fibra de vidro* ou *tela de arame*. As gaxetas metálicas são feitas comumente de folha enrolada em torno de uma alma de amianto e podem ser enrugadas para aumentar a resiliência ou reter lubrificante. Também podem ser usadas capas metálicas trançadas para esse fim.**

### Relações de Medidas:

- 1º Seqüência de medidas interno x externo e alturas
- 2º Conferir modelos na última página
- 3º Alguns modelos estão sem identificação (favor consultar)
- 4º Gaxetas UL (ver desenho U093)





Cód	Mod	Di x	De x	Esp. x	Ha1 x	Ha2	Cód	Mod	Di x	De x	Esp. x	Ha1 x	Ha2
3291	C	— x	4.60 x	1.60 x	9.52 x	—	53566	U002	4.00 x	8.00 x	— x	2.00 x	—
3399	C	— x	17.00 x	— x	4.80 x	—	52619	U001	4.00 x	8.00 x	— x	3.20 x	—
3034	C	— x	17.00 x	— x	9.50 x	—	50725	U031	4.00 x	8.00 x	— x	6.30 x	—
3043	C	— x	17.50 x	— x	7.00 x	—	52192	U063	4.00 x	8.50 x	— x	6.80 x	—
3030	C	— x	19.05 x	— x	5.16 x	—	52192	U063	4.00 x	8.50 x	— x	6.80 x	—
3076	C	— x	20.20 x	— x	7.00 x	—	50774	U	4.00 x	9.00 x	— x	3.00 x	—
3536	C	— x	21.80 x	— x	8.50 x	—	3210	C	4.00 x	9.00 x	— x	4.50 x	—
3052	C	— x	23.00 x	8.00 x	27.00 x	—	53567	U001	4.00 x	10.00 x	— x	4.00 x	—
3109	C	— x	25.40 x	— x	10.00 x	—	53568	U002	4.00 x	10.00 x	— x	4.00 x	—
3233	C	— x	26.00 x	8.00 x	27.00 x	—	53569	U031	4.00 x	10.00 x	— x	4.00 x	—
3430	C	— x	27.00 x	— x	10.00 x	—	53570	U002	4.00 x	12.00 x	— x	4.00 x	—
3423	C	— x	30.00 x	— x	10.00 x	—	51301	U	4.00 x	12.00 x	— x	4.50 x	—
3480	C	— x	31.00 x	— x	6.00 x	—	53571	U001	4.00 x	12.00 x	— x	5.20 x	—
3297	C	— x	31.00 x	— x	7.50 x	—	53572	U002	4.00 x	12.00 x	— x	5.20 x	—
3479	C	— x	35.00 x	— x	8.00 x	—	53573	U004	4.00 x	12.00 x	— x	6.00 x	—
3165	C	— x	38.10 x	— x	9.52 x	—	59228	U001	4.00 x	12.00 x	— x	8.00 x	—
3165	C	— x	38.10 x	— x	9.52 x	—	53574	U002	4.00 x	12.00 x	— x	8.00 x	—
3063	C	— x	44.45 x	— x	11.50 x	—	53575	U007	4.00 x	12.00 x	— x	8.00 x	—
3476	C	— x	52.70 x	— x	10.00 x	—	50956	U	4.00 x	12.20 x	— x	5.70 x	—
3477	C	— x	72.40 x	— x	9.00 x	—	53576	U001	4.00 x	13.00 x	— x	8.00 x	—
3302	C	— x	78.50 x	— x	15.00 x	—	53577	U002	4.00 x	13.00 x	— x	8.00 x	—
3525	C	— x	80.00 x	— x	6.00 x	—	53578	U001	4.00 x	14.00 x	— x	4.50 x	—
3470	C	— x	80.00 x	3.50 x	13.00 x	—	53579	U002	4.00 x	14.00 x	— x	4.50 x	—
3499	C024	— x	120.00 x	5.00 x	12.00 x	—	53580	U	4.00 x	17.00 x	— x	9.40 x	—
3543	C	1.00 x	20.00 x	2.00 x	8.00 x	—	50012	U097	4.00 x	17.00 x	— x	9.40 x	—
55600	U	1.50 x	3.50 x	— x	1.40 x	—	3503	C	4.00 x	18.30 x	5.00 x	16.00 x	—
59310	U001	1.50 x	4.20 x	— x	1.60 x	2.00	3452	C	4.00 x	20.50 x	2.50 x	8.00 x	—
51300	U004	2.00 x	5.00 x	— x	2.00 x	—	3069	C	4.00 x	23.00 x	2.50 x	6.50 x	—
51300	U004	2.00 x	5.00 x	— x	2.00 x	—	55738	U007	4.20 x	9.50 x	— x	2.70 x	3.20
53549	U002	2.00 x	5.00 x	— x	2.50 x	—	52617	U	4.50 x	7.50 x	— x	2.80 x	—
53550	U001	2.00 x	10.00 x	— x	3.80 x	—	53581	U001	4.50 x	7.50 x	— x	3.00 x	—
53551	U002	2.00 x	10.00 x	— x	3.80 x	—	53582	U002	4.50 x	7.50 x	— x	3.00 x	—
59227	U001	2.00 x	12.00 x	— x	5.00 x	—	53583	U001	4.50 x	8.00 x	— x	3.00 x	—
53552	U002	2.00 x	12.00 x	— x	5.00 x	—	53584	U002	4.50 x	8.00 x	— x	3.00 x	—
3387	C	2.30 x	6.00 x	— x	3.20 x	—	55715	U	4.50 x	8.00 x	— x	3.20 x	—
3049	C	2.30 x	9.50 x	4.00 x	10.00 x	—	53585	U005	4.50 x	10.00 x	— x	2.50 x	—
53359	U	2.50 x	4.50 x	— x	1.40 x	—	53586	U006	4.50 x	10.00 x	— x	2.50 x	—
53359	U002	2.50 x	4.50 x	— x	1.40 x	—	52841	U	4.50 x	10.00 x	— x	4.00 x	—
55609	U002	2.50 x	4.80 x	— x	1.50 x	—	52841	U002	4.50 x	10.00 x	— x	4.00 x	—
55577	U	2.60 x	10.80 x	— x	4.80 x	—	53587	U002	4.50 x	10.00 x	— x	4.00 x	—
55543	U	2.60 x	16.50 x	— x	2.20 x	—	52068	U	4.50 x	10.50 x	— x	2.70 x	—
3070	C	2.60 x	22.80 x	1.00 x	8.00 x	—	52871	U011	4.50 x	11.30 x	— x	4.60 x	—
53155	U001	3.00 x	5.80 x	— x	2.00 x	—	52065	U	4.50 x	11.80 x	— x	7.90 x	—
52625	U001	3.00 x	7.00 x	— x	5.00 x	—	51985	U	4.50 x	12.00 x	— x	4.70 x	—
53553	U002	3.00 x	7.00 x	— x	5.00 x	—	51985	U	4.50 x	12.00 x	— x	4.70 x	—
51286	U003	3.00 x	7.14 x	— x	4.00 x	—	53588	U001	4.60 x	12.00 x	— x	5.00 x	—
51286	U003	3.00 x	7.14 x	— x	4.00 x	—	53589	U002	4.60 x	12.00 x	— x	5.00 x	—
50984	U	3.00 x	7.50 x	— x	2.50 x	—	53590	U001	4.70 x	7.50 x	— x	3.00 x	—
53554	U001	3.00 x	8.00 x	— x	3.50 x	—	53591	U002	4.70 x	7.50 x	— x	3.00 x	—
53555	U002	3.00 x	8.00 x	— x	3.50 x	—	53592	U019	4.70 x	10.50 x	— x	4.00 x	—
53556	U001	3.00 x	8.00 x	— x	4.00 x	—	52107	U001	4.70 x	12.00 x	— x	4.00 x	—
53557	U002	3.00 x	8.00 x	— x	4.00 x	—	53593	U002	4.70 x	12.00 x	— x	4.00 x	—
51137	U	3.00 x	8.50 x	— x	3.00 x	—	50135	U081	4.75 x	9.45 x	— x	3.17 x	—
53558	U003	3.00 x	8.50 x	— x	3.50 x	—	53594	U001	4.75 x	11.00 x	— x	4.00 x	—
53559	U001	3.00 x	9.00 x	— x	4.00 x	—	52658	U	4.75 x	11.00 x	— x	4.50 x	—
53560	U002	3.00 x	9.00 x	— x	4.00 x	—	50153	U098	4.76 x	9.52 x	— x	3.97 x	—
52575	U	3.00 x	9.50 x	— x	3.20 x	—	53595	U019	4.76 x	9.53 x	— x	2.38 x	—
52575	U	3.00 x	9.50 x	— x	3.20 x	—	52120	U	4.76 x	10.80 x	— x	2.38 x	—
53561	U004	3.00 x	10.00 x	— x	6.00 x	—	53596	U002	4.76 x	11.00 x	— x	4.00 x	—
59459	U-02	3.17 x	6.35 x	— x	3.17 x	—	53597	U005	4.76 x	11.11 x	— x	4.76 x	—
53562	U019	3.18 x	7.94 x	— x	2.38 x	—	53598	U002	4.76 x	11.91 x	— x	9.92 x	—
53563	U003	3.18 x	7.94 x	— x	3.18 x	—	50469	U002	4.76 x	12.70 x	— x	4.76 x	—
55670	U031	3.30 x	5.70 x	— x	1.20 x	1.70	3039	C	4.76 x	12.70 x	2.00 x	7.94 x	—
52121	U004	3.40 x	6.60 x	— x	1.94 x	—	53599	U002	4.76 x	12.70 x	— x	10.32 x	—
51418	U	3.50 x	7.50 x	— x	2.50 x	—	50194	U002	4.76 x	14.29 x	— x	4.76 x	—
52726	U	3.50 x	8.00 x	— x	3.00 x	—	50511	U077	4.76 x	14.29 x	— x	4.76 x	—
50808	U	3.50 x	12.00 x	— x	8.30 x	—	53600	U002	4.76 x	14.29 x	— x	5.16 x	—
53564	U001	3.90 x	7.50 x	— x	3.00 x	—	50442	U005	4.76 x	15.87 x	— x	7.14 x	—
50019	U002	3.90 x	14.00 x	— x	4.50 x	—	55686	U007	4.80 x	9.70 x	— x	2.75 x	3.20
50019	U002	3.90 x	14.00 x	— x	4.50 x	—	53601	U001	4.90 x	30.00 x	— x	10.00 x	—
52607	U	4.00 x	6.00 x	— x	3.00 x	—	53602	U002	4.90 x	30.00 x	— x	10.00 x	—
52607	U002	4.00 x	6.00 x	— x	3.00 x	—	55734	U031	5.00 x	7.80 x	— x	1.60 x	—
52673	U	4.00 x	7.00 x	— x	3.00 x	—	55608	U	5.00 x	8.00 x	— x	2.50 x	—
50008	U006	4.00 x	7.50 x	— x	2.80 x	—	53603	U	5.00 x	9.00 x	— x	2.40 x	—
50008	U006	4.00 x	7.50 x	— x	2.80 x	—	50014	U002	5.00 x	9.00 x	— x	2.40 x	—
51097	U	4.00 x	7.50 x	— x	3.00 x	—	53604	U002	5.00 x	9.00 x	— x	3.00 x	—
52966	U001	4.00 x	7.50 x	— x	3.00 x	—	55598	U	5.00 x	10.00 x	— x	3.00 x	—
53565	U002	4.00 x	7.50 x	— x	3.00 x	—	53605	U007	5.00 x	10.00 x	— x	3.20 x	—
8295	V	4.00 x	7.50 x	— x	3.00 x	—	53606	U008	5.00 x	10.00 x	— x	3.20 x	—
3260	C	4.00 x	7.80 x	— x	3.00 x	—	53607	U008	5.00 x	10.00 x	— x	3.20 x	—



Cód	Mod	Di x	De x	Esp. x	Ha1 x	Ha2	Cód	Mod	Di x	De x	Esp. x	Ha1 x	Ha2
53608	U007	5.00 x	10.00 x	— x	6.50 x	—	51006	U013	6.00 x	12.00 x	— x	5.00 x	—
53609	U008	5.00 x	10.00 x	— x	6.50 x	—	53646	U001	6.00 x	12.00 x	— x	6.00 x	—
53610	U008	5.00 x	10.00 x	— x	6.50 x	—	51160	U021	6.00 x	12.00 x	— x	6.00 x	—
53104	U	5.00 x	11.00 x	— x	3.50 x	—	53647	U003	6.00 x	12.00 x	— x	7.00 x	—
53611	U001	5.00 x	11.00 x	— x	5.00 x	—	53648	U002	6.00 x	12.00 x	— x	8.00 x	—
53612	U002	5.00 x	11.00 x	— x	5.00 x	—	53649	U003	6.00 x	12.50 x	— x	4.70 x	—
53613	U002	5.00 x	12.00 x	— x	3.50 x	—	53650	U007	6.00 x	12.50 x	— x	5.00 x	—
52130	U002	5.00 x	12.00 x	— x	5.00 x	—	51606	U	6.00 x	13.00 x	— x	8.00 x	—
52130	U002	5.00 x	12.00 x	— x	5.00 x	—	53651	U004	6.00 x	13.00 x	— x	8.00 x	—
53614	U002	5.00 x	12.00 x	— x	5.00 x	—	3393	C	6.00 x	14.00 x	— x	5.00 x	—
53615	U019	5.00 x	12.00 x	— x	5.00 x	—	50451	U019	6.00 x	14.00 x	— x	5.00 x	—
53616	U004	5.00 x	12.00 x	— x	5.50 x	—	59237	U004	6.00 x	14.00 x	— x	5.70 x	—
53617	U004	5.00 x	12.00 x	— x	6.00 x	—	53652	U005	6.00 x	14.00 x	— x	9.00 x	—
51405	U	5.00 x	12.00 x	— x	9.00 x	7.00	53654	U006	6.00 x	14.00 x	— x	9.00 x	—
53618	U005	5.00 x	12.00 x	— x	9.00 x	—	53653	U006	6.00 x	14.00 x	— x	9.00 x	—
53619	U006	5.00 x	12.00 x	— x	9.00 x	—	53655	U001	6.00 x	15.00 x	— x	5.00 x	—
3548	C	5.00 x	12.00 x	— x	10.00 x	—	53656	U002	6.00 x	15.00 x	— x	5.00 x	—
51623	U002	5.00 x	12.50 x	— x	4.00 x	—	53657	U001	6.00 x	15.00 x	— x	6.00 x	—
50021	U056	5.00 x	12.70 x	— x	5.00 x	—	50978	U	6.00 x	15.00 x	— x	8.00 x	—
55727	U002	5.00 x	12.70 x	— x	6.00 x	—	50978	U	6.00 x	15.00 x	— x	8.00 x	—
53620	U001	5.00 x	13.00 x	— x	4.50 x	—	53658	U003	6.00 x	15.50 x	— x	4.50 x	—
53621	U002	5.00 x	13.00 x	— x	4.50 x	—	53660	U001	6.00 x	16.00 x	— x	5.00 x	—
53622	U002	5.00 x	13.00 x	— x	5.00 x	—	51822	U002	6.00 x	16.00 x	— x	5.00 x	—
53623	U004	5.00 x	13.00 x	— x	6.00 x	—	53659	U002	6.00 x	16.00 x	— x	5.00 x	—
53625	U001	5.00 x	14.00 x	— x	4.50 x	—	53661	U002	6.00 x	16.00 x	— x	7.00 x	—
53626	U002	5.00 x	14.00 x	— x	4.50 x	—	53662	U001	6.00 x	16.00 x	— x	8.00 x	—
53627	U001	5.00 x	14.00 x	— x	7.00 x	—	53663	U002	6.00 x	16.00 x	— x	8.00 x	—
53628	U002	5.00 x	14.00 x	— x	7.00 x	—	F15451	W	6.00 x	16.50 x	— x	3.20 x	4.30
50519	U002	5.00 x	15.00 x	— x	4.00 x	—	F15451	U007	6.00 x	16.50 x	3.20 x	4.30 x	—
53629	U001	5.00 x	15.00 x	— x	5.00 x	—	50960	U	6.00 x	16.50 x	— x	6.30 x	—
53630	U002	5.00 x	15.00 x	— x	5.00 x	—	51946	U001	6.00 x	16.70 x	— x	6.00 x	—
53631	U004	5.00 x	15.00 x	— x	5.00 x	—	53665	U002	6.00 x	17.00 x	— x	6.00 x	—
53632	U001	5.00 x	15.00 x	— x	8.00 x	—	53666	U019	6.00 x	17.00 x	— x	6.00 x	—
F13518	ESPE	5.00 x	15.00 x	— x	16.50 x	1.00	52680	U031	6.00 x	17.00 x	— x	6.00 x	—
53633	U001	5.00 x	16.00 x	— x	8.00 x	—	50018	U002	6.00 x	17.00 x	— x	7.00 x	—
53634	U001	5.00 x	17.00 x	— x	9.00 x	—	50016	U031	6.00 x	17.50 x	— x	8.30 x	—
53635	U002	5.00 x	17.00 x	— x	9.00 x	—	53667	U001	6.00 x	18.00 x	— x	8.00 x	—
52681	U032	5.00 x	18.50 x	— x	4.50 x	—	53668	U002	6.00 x	18.00 x	— x	8.00 x	—
3053	C	5.20 x	34.50 x	— x	12.00 x	—	53669	U019	6.00 x	18.00 x	— x	8.00 x	—
50939	U	5.50 x	8.00 x	— x	4.00 x	—	53670	U002	6.00 x	18.00 x	— x	8.50 x	—
53316	U031	5.50 x	10.00 x	— x	4.00 x	—	53671	U001	6.00 x	18.00 x	— x	9.00 x	—
53637	U001	5.50 x	11.00 x	— x	3.00 x	—	53672	U002	6.00 x	18.00 x	— x	9.00 x	—
52865	U077	5.50 x	11.00 x	— x	7.00 x	—	53673	U002	6.00 x	18.00 x	— x	9.00 x	—
52865	U077	5.50 x	11.00 x	— x	7.00 x	—	53045	U	6.00 x	18.00 x	— x	9.50 x	—
53639	U002	5.50 x	11.10 x	— x	3.00 x	—	53045	U001	6.00 x	18.00 x	— x	10.00 x	9.50
52009	U031	5.50 x	11.10 x	— x	3.00 x	—	53045	U001	6.00 x	18.00 x	— x	10.00 x	—
53640	U001	5.50 x	11.20 x	— x	3.00 x	—	53674	U002	6.00 x	18.00 x	— x	10.00 x	—
53514	UL	5.50 x	12.00 x	— x	4.30 x	6.00	53302	U001	6.00 x	20.00 x	— x	8.00 x	—
53641	U008	5.50 x	12.50 x	— x	8.00 x	—	53675	U002	6.00 x	20.00 x	— x	8.00 x	—
53642	U008	5.50 x	12.50 x	— x	8.00 x	—	53676	U019	6.00 x	20.00 x	— x	8.00 x	—
59270	U026	5.50 x	12.60 x	— x	3.50 x	—	53677	U001	6.00 x	20.00 x	— x	11.00 x	—
53643	U007	5.56 x	11.11 x	— x	3.97 x	—	53678	U002	6.00 x	20.00 x	— x	11.00 x	—
53644	U005	5.90 x	12.00 x	— x	4.00 x	—	53679	U002	6.00 x	20.00 x	— x	11.00 x	—
53645	U006	5.90 x	12.00 x	— x	4.00 x	—	53680	U003	6.00 x	20.00 x	— x	13.00 x	—
51838	U002	6.00 x	9.20 x	— x	2.50 x	—	53681	U001	6.00 x	22.00 x	— x	8.00 x	—
59281	U	6.00 x	10.00 x	— x	2.40 x	—	53682	U002	6.00 x	22.00 x	— x	8.00 x	—
55634	U	6.00 x	10.00 x	— x	3.00 x	—	53683	U003	6.00 x	22.00 x	— x	8.00 x	—
51312	U030	6.00 x	10.00 x	— x	3.00 x	2.50	53684	U003	6.00 x	22.00 x	— x	15.00 x	—
52132	U	6.00 x	10.00 x	— x	4.00 x	—	53685	U001	6.00 x	25.00 x	— x	6.00 x	—
51271	U002	6.00 x	11.00 x	— x	2.50 x	—	53686	U002	6.00 x	25.00 x	— x	6.00 x	—
50914	U031	6.00 x	11.00 x	— x	3.50 x	—	53048	U	6.00 x	26.00 x	— x	13.00 x	—
51666	U049	6.00 x	11.00 x	— x	4.50 x	—	53048	U	6.00 x	26.00 x	— x	13.50 x	—
53476	U	6.00 x	11.00 x	— x	7.00 x	—	53687	U002	6.30 x	11.00 x	— x	2.50 x	—
50669	U002	6.00 x	11.50 x	— x	4.00 x	—	53688	U001	6.30 x	12.00 x	— x	6.00 x	—
—	U001	6.00 x	12.00 x	— x	4.00 x	—	53689	U002	6.30 x	12.00 x	— x	6.00 x	—
51126	U031	6.00 x	12.00 x	— x	4.00 x	—	50365	U006	6.30 x	12.40 x	— x	4.20 x	—
53414	U005	6.00 x	12.00 x	— x	4.40 x	—	53690	U001	6.30 x	12.60 x	— x	5.00 x	—



Cód	Mod	Di x	De x	Esp. x	Ha1 x	Ha2	Cód	Mod	Di x	De x	Esp. x	Ha1 x	Ha2
53691	U002	6.30 x	12.60 x	— x	5.00 x	—	53721	U002	7.00 x	12.50 x	— x	3.50 x	—
53692	U008	6.30 x	14.00 x	— x	6.00 x	—	52609	U	7.00 x	12.50 x	— x	4.00 x	—
53693	U008	6.30 x	14.00 x	— x	6.00 x	—	59269	U004	7.00 x	12.60 x	— x	4.00 x	—
53694	U002	6.35 x	9.53 x	— x	2.38 x	—	50237	U002	7.00 x	12.70 x	— x	3.00 x	—
52981	U	6.35 x	11.00 x	— x	2.50 x	—	53722	U002	7.00 x	14.00 x	— x	3.00 x	—
52981	U031	6.35 x	11.00 x	— x	2.50 x	—	53723	U001	7.00 x	14.00 x	— x	3.50 x	—
51075	U	6.35 x	11.11 x	— x	3.17 x	—	53724	U002	7.00 x	14.00 x	— x	3.50 x	—
53695	U019	6.35 x	11.11 x	— x	3.18 x	—	55602	U	7.00 x	14.00 x	— x	3.80 x	—
50392	U003	6.35 x	11.11 x	— x	3.40 x	—	53726	U002	7.00 x	15.00 x	— x	5.00 x	—
53696	U002	6.35 x	11.11 x	— x	3.57 x	—	53725	U004	7.00 x	15.00 x	— x	5.00 x	—
53697	U001	6.35 x	11.11 x	— x	5.00 x	—	53725	U004	7.00 x	15.00 x	— x	5.00 x	—
53698	U002	6.35 x	11.11 x	— x	5.00 x	—	51020	U	7.00 x	15.00 x	— x	5.50 x	4.00
52855	U	6.35 x	12.00 x	— x	3.50 x	—	53727	U001	7.00 x	15.00 x	— x	7.00 x	—
55548	U005	6.35 x	12.00 x	— x	4.00 x	—	53728	U002	7.00 x	15.00 x	— x	7.00 x	—
51477	U002	6.35 x	12.50 x	— x	3.00 x	—	53729	U004	7.00 x	15.00 x	— x	8.00 x	—
50773	U	6.35 x	12.70 x	— x	3.17 x	—	52293	U020	7.00 x	16.50 x	— x	6.00 x	—
53699	U002	6.35 x	12.70 x	— x	3.18 x	—	50024	U002	7.00 x	17.00 x	— x	7.00 x	—
53700	U002	6.35 x	12.70 x	— x	3.57 x	—	53730	U003	7.00 x	18.00 x	— x	6.00 x	—
52448	U	6.35 x	12.70 x	— x	3.97 x	—	3007	C	7.00 x	19.00 x	3.00 x	9.00 x	3.00
53701	U	6.35 x	12.70 x	— x	4.76 x	—	53731	U001	7.00 x	22.00 x	— x	8.00 x	—
50340	U002	6.35 x	12.70 x	— x	4.76 x	—	53732	U002	7.00 x	22.00 x	— x	8.00 x	—
50443	U002	6.35 x	12.70 x	— x	6.35 x	—	50491	U061	7.00 x	25.00 x	— x	8.00 x	—
55756	U002	6.35 x	12.70 x	— x	6.35 x	—	3466	C	7.00 x	102.00 x	— x	5.50 x	—
53702	U004	6.35 x	12.70 x	— x	6.35 x	—	3466	C	7.00 x	102.00 x	5.50 x	23.90 x	—
51769	U031	6.35 x	12.70 x	— x	9.50 x	—	3466	C	7.00 x	102.00 x	— x	23.90 x	—
51769	U031	6.35 x	12.70 x	— x	9.50 x	—	3035	C	7.14 x	25.40 x	2.50 x	9.52 x	—
50719	U	6.35 x	13.10 x	— x	3.57 x	—	59447	U	7.20 x	12.80 x	— x	4.60 x	—
50796	U	6.35 x	14.29 x	— x	4.76 x	—	53733	U001	7.20 x	28.00 x	— x	10.00 x	—
50422	U002	6.35 x	15.87 x	— x	7.94 x	—	53734	U002	7.20 x	28.00 x	— x	10.00 x	—
3000	C	6.35 x	15.87 x	1.59 x	9.52 x	—	53735	U001	7.20 x	30.00 x	— x	10.00 x	—
53703	U002	6.35 x	15.88 x	— x	3.57 x	—	53736	U002	7.20 x	30.00 x	— x	10.00 x	—
6363	CH	6.35 x	15.88 x	— x	11.91 x	—	52068	U	7.50 x	10.50 x	— x	2.70 x	—
3282	C	6.35 x	19.05 x	— x	7.93 x	—	51512	U	7.50 x	13.00 x	— x	3.30 x	—
—	CH	6.35 x	22.23 x	— x	29.00 x	—	52148	U	7.50 x	14.00 x	— x	4.00 x	—
3506	C	6.40 x	37.00 x	— x	12.70 x	—	51600	U	7.50 x	14.50 x	— x	4.50 x	—
53704	U002	6.50 x	11.00 x	— x	3.00 x	—	53737	U002	7.50 x	14.50 x	— x	4.50 x	—
53705	U001	6.50 x	11.00 x	— x	3.50 x	—	53738	U001	7.50 x	15.00 x	— x	5.00 x	—
53706	U003	6.50 x	12.00 x	— x	4.00 x	—	53739	U002	7.50 x	15.00 x	— x	5.00 x	—
53707	U007	6.50 x	12.00 x	— x	4.00 x	—	3283	C	7.50 x	16.00 x	— x	5.00 x	—
53708	U002	6.50 x	12.50 x	— x	3.00 x	—	6290	CH	7.50 x	17.50 x	— x	26.00 x	—
53709	U002	6.50 x	14.00 x	— x	4.00 x	—	53740	U003	7.54 x	19.05 x	— x	4.37 x	—
53710	U	6.50 x	14.50 x	— x	4.00 x	5.50	3335	C	7.54 x	25.40 x	2.30 x	7.93 x	—
50383	U009	6.50 x	14.50 x	— x	5.50 x	4.00	53741	U001	7.80 x	15.00 x	— x	3.50 x	—
53711	U002	6.50 x	15.00 x	— x	6.00 x	—	53742	U002	7.80 x	15.00 x	— x	3.50 x	—
53712	U004	6.50 x	16.00 x	— x	8.30 x	—	53494	U	7.93 x	14.28 x	— x	3.17 x	—
53713	U004	6.50 x	16.00 x	— x	8.30 x	—	50470	U003	7.94 x	12.70 x	— x	4.76 x	—
3310	C	6.50 x	17.00 x	— x	5.50 x	—	53743	U019	7.94 x	14.29 x	— x	3.18 x	—
53714	U	6.50 x	28.50 x	— x	3.70 x	4.70	53455	U	7.94 x	14.29 x	— x	6.35 x	—
50499	U100	6.50 x	28.50 x	— x	4.70 x	3.70	53744	U	7.94 x	15.08 x	— x	6.35 x	—
53381	U002	6.52 x	32.50 x	— x	7.70 x	—	50455	U077	7.94 x	15.08 x	— x	6.75 x	—
59282	U008	6.70 x	11.20 x	— x	2.20 x	2.50	50209	U002	7.94 x	15.87 x	— x	3.17 x	—
52516	U001	6.70 x	12.00 x	— x	2.60 x	—	50674	U002	7.94 x	15.87 x	— x	3.97 x	—
50010	U031	6.70 x	13.00 x	— x	3.50 x	—	50338	U002	7.94 x	15.87 x	— x	6.00 x	—
55680	U	6.80 x	10.50 x	— x	3.90 x	—	50181	U002	7.94 x	15.87 x	— x	6.35 x	—
55672	U004	6.90 x	11.50 x	— x	2.50 x	—	50815	U008	7.94 x	15.87 x	— x	6.35 x	—
53715	U002	7.00 x	10.00 x	— x	3.00 x	—	53745	U008	7.94 x	15.88 x	— x	5.56 x	—
52743	U	7.00 x	10.50 x	— x	5.30 x	—	53746	U008	7.94 x	15.88 x	— x	5.56 x	—
50772	U	7.00 x	11.00 x	— x	4.50 x	—	53747	U002	7.94 x	15.88 x	— x	6.35 x	—
53172	U001	7.00 x	12.00 x	— x	2.60 x	—	53748	U002	7.94 x	15.88 x	— x	7.94 x	—
53172	U001	7.00 x	12.00 x	— x	2.60 x	—	53749	U002	7.94 x	17.46 x	— x	4.76 x	—
53420	U003	7.00 x	12.00 x	— x	3.50 x	—	50221	U002	7.94 x	17.46 x	— x	5.56 x	—
53716	U002	7.00 x	12.00 x	— x	4.00 x	—	53456	U	7.94 x	17.46 x	— x	7.94 x	—
53717	U007	7.00 x	12.00 x	— x	4.00 x	—	53457	U	7.94 x	20.64 x	— x	9.53 x	—
53719	U008	7.00 x	12.00 x	— x	4.00 x	—	53457	U	7.94 x	20.64 x	— x	9.53 x	—
53718	U008	7.00 x	12.00 x	— x	4.00 x	—	3213	C	7.94 x	22.22 x	3.00 x	8.73 x	—
53421	U031	7.00 x	12.00 x	— x	4.40 x	—	3115	C	7.94 x	38.10 x	— x	11.91 x	—
53720	U001	7.00 x	12.50 x	— x	3.50 x	—	3097	C	7.94 x	201.61 x	6.35 x	23.81 x	—



Cód	Mod	Di x	De x	Esp. x	Ha1 x	Ha2	Cód	Mod	Di x	De x	Esp. x	Ha1 x	Ha2
52731	U031	8.00 x	12.00 x	— x	2.60 x	—	53788	U001	8.00 x	24.00 x	— x	8.00 x	—
50496	U006	8.00 x	13.00 x	— x	4.00 x	—	53789	U001	8.00 x	24.00 x	— x	10.00 x	—
53750	U005	8.00 x	13.50 x	— x	5.00 x	—	53790	U001	8.00 x	24.00 x	— x	12.00 x	—
53751	U001	8.00 x	14.00 x	— x	3.00 x	—	53791	U002	8.00 x	24.00 x	— x	12.00 x	—
53752	U001	8.00 x	14.00 x	— x	3.00 x	—	53792	U001	8.00 x	25.00 x	— x	6.00 x	—
53753	U002	8.00 x	14.00 x	— x	3.50 x	—	53793	U002	8.00 x	25.00 x	— x	6.00 x	—
53754	U002	8.00 x	14.00 x	— x	4.00 x	—	53794	U019	8.00 x	25.00 x	— x	6.00 x	—
50471	U003	8.00 x	14.00 x	— x	4.00 x	—	53796	U	8.00 x	26.00 x	— x	8.00 x	—
53755	U019	8.00 x	14.00 x	— x	4.00 x	—	53795	U001	8.00 x	26.00 x	— x	8.00 x	—
51066	U	8.00 x	14.00 x	— x	4.50 x	—	—	CH	8.00 x	26.00 x	— x	49.00 x	—
51031	U065	8.00 x	14.00 x	— x	4.50 x	—	3376	C	8.00 x	27.00 x	1.50 x	3.50 x	—
53756	U001	8.00 x	14.00 x	— x	6.00 x	—	53797	U001	8.00 x	28.00 x	— x	8.00 x	—
53757	U002	8.00 x	14.00 x	— x	6.00 x	—	53798	U002	8.00 x	28.00 x	— x	8.00 x	—
52834	U011	8.00 x	14.30 x	— x	3.90 x	—	53799	U001	8.00 x	30.00 x	— x	10.00 x	—
59338	U021	8.00 x	14.50 x	— x	4.00 x	5.20	53800	U002	8.00 x	30.00 x	— x	10.00 x	—
50660	U047	8.00 x	14.50 x	— x	4.00 x	—	3439	C	8.00 x	34.00 x	4.50 x	7.50 x	—
51212	U002	8.00 x	15.00 x	— x	3.00 x	—	3441	C	8.25 x	30.50 x	2.10 x	7.00 x	—
51202	U007	8.00 x	15.00 x	— x	5.50 x	4.50	3026	C	8.30 x	27.00 x	2.90 x	8.30 x	—
53758	U007	8.00 x	15.00 x	— x	5.50 x	—	53801	U006	8.33 x	14.29 x	— x	3.97 x	—
53759	U002	8.00 x	15.00 x	— x	6.00 x	—	53039	U028	8.50 x	14.00 x	— x	3.20 x	2.20
50577	U002	8.00 x	15.00 x	— x	6.00 x	—	51854	U	8.50 x	14.00 x	— x	4.00 x	—
53760	U019	8.00 x	15.00 x	— x	6.00 x	—	53802	U006	8.50 x	14.00 x	— x	4.00 x	—
50577	U031	8.00 x	15.00 x	— x	6.00 x	—	59437	U033	8.50 x	14.00 x	— x	4.00 x	—
53761	U004	8.00 x	15.00 x	— x	8.00 x	—	53039	U028	8.50 x	14.22 x	— x	3.20 x	—
53762	U007	8.00 x	15.50 x	— x	5.50 x	—	50251	U031	8.50 x	15.50 x	— x	3.00 x	—
53768	U	8.00 x	16.00 x	— x	3.50 x	5.50	59280	U002	8.50 x	15.70 x	— x	6.00 x	—
53763	U001	8.00 x	16.00 x	— x	4.00 x	—	53803	U001	8.50 x	17.00 x	— x	6.50 x	—
53764	U002	8.00 x	16.00 x	— x	4.00 x	—	52774	U	8.50 x	20.00 x	— x	8.50 x	—
50659	U088	8.00 x	16.00 x	— x	5.30 x	4.30	3341	C001	8.50 x	22.50 x	— x	12.00 x	—
50378	U101	8.00 x	16.00 x	— x	5.50 x	3.50	3420	C	8.50 x	48.80 x	— x	12.50 x	—
51608	U	8.00 x	16.00 x	— x	6.00 x	—	8247	V	8.70 x	19.05 x	— x	3.96 x	—
53765	U002	8.00 x	16.00 x	— x	6.00 x	—	53804	U006	8.73 x	14.29 x	— x	3.79 x	—
53766	U019	8.00 x	16.00 x	— x	6.00 x	—	53805	U007	8.73 x	15.88 x	— x	5.56 x	—
59285	U004	8.00 x	16.00 x	— x	6.35 x	—	53806	U008	8.73 x	15.88 x	— x	5.56 x	—
3397	C	8.00 x	16.00 x	— x	6.50 x	—	53075	U021	8.80 x	14.00 x	— x	2.20 x	—
3397	C	8.00 x	16.00 x	— x	6.50 x	—	53075	U	8.80 x	14.00 x	— x	3.20 x	—
53767	U004	8.00 x	16.00 x	— x	8.00 x	—	50162	U031	8.80 x	19.30 x	— x	6.00 x	—
51656	U031	8.00 x	16.00 x	— x	8.00 x	—	51887	U004	9.00 x	12.00 x	— x	2.00 x	—
6365	CH	8.00 x	16.00 x	— x	15.85 x	—	59431	U	9.00 x	12.00 x	— x	2.30 x	—
53769	U002	8.00 x	17.00 x	— x	5.00 x	—	53808	U002	9.00 x	12.00 x	— x	2.50 x	—
53770	U001	8.00 x	17.00 x	— x	6.00 x	—	52947	U	9.00 x	13.00 x	— x	5.50 x	—
53771	U002	8.00 x	17.00 x	— x	6.00 x	—	52947	U007	9.00 x	13.00 x	— x	5.50 x	—
51969	U	8.00 x	17.00 x	— x	6.50 x	—	53809	U001	9.00 x	13.50 x	— x	4.00 x	—
3081	C	8.00 x	18.00 x	— x	8.00 x	—	53810	U002	9.00 x	13.50 x	— x	4.00 x	—
51782	U001	8.00 x	18.00 x	— x	8.00 x	—	50483	U019	9.00 x	14.00 x	— x	4.00 x	—
53772	U002	8.00 x	18.00 x	— x	8.00 x	—	51438	U002	9.00 x	14.50 x	— x	4.30 x	—
53773	U002	8.00 x	18.00 x	— x	9.00 x	—	53811	U001	9.00 x	15.00 x	— x	8.00 x	—
53774	U001	8.00 x	18.00 x	— x	10.00 x	—	53812	U002	9.00 x	15.00 x	— x	8.00 x	—
53775	U002	8.00 x	18.00 x	— x	10.00 x	—	53813	U005	9.00 x	15.00 x	— x	8.00 x	—
—	CH	8.00 x	18.00 x	— x	22.00 x	—	53814	U007	9.00 x	15.00 x	— x	8.00 x	—
53776	U002	8.00 x	19.00 x	— x	5.00 x	—	53815	U011	9.00 x	15.00 x	— x	8.00 x	—
51043	U	8.00 x	19.00 x	— x	6.00 x	—	52141	U	9.00 x	15.50 x	— x	8.00 x	—
53777	U002	8.00 x	20.00 x	— x	6.00 x	—	52883	U	9.00 x	15.80 x	— x	4.00 x	—
3128	C	8.00 x	20.00 x	2.50 x	7.00 x	—	53816	U001	9.00 x	16.00 x	— x	4.00 x	—
53778	U001	8.00 x	20.00 x	— x	8.00 x	—	53817	U002	9.00 x	16.00 x	— x	4.00 x	—
53779	U002	8.00 x	20.00 x	— x	8.00 x	—	51665	U	9.00 x	16.00 x	— x	5.00 x	—
53780	U005	8.00 x	20.00 x	— x	8.00 x	—	53818	U003	9.00 x	16.00 x	— x	5.00 x	—
53781	U006	8.00 x	20.00 x	— x	8.00 x	—	50465	U019	9.00 x	16.00 x	— x	5.00 x	—
53782	U002	8.00 x	20.00 x	— x	9.00 x	—	53819	U002	9.00 x	16.00 x	— x	6.00 x	—
53783	U002	8.00 x	20.00 x	— x	13.00 x	—	51536	U004	9.00 x	16.40 x	— x	4.80 x	—
52204	U017	8.00 x	22.00 x	— x	7.00 x	—	51943	U027	9.00 x	16.50 x	— x	4.00 x	—
53784	U001	8.00 x	22.00 x	— x	8.00 x	—	53820	U001	9.00 x	16.50 x	— x	6.00 x	—
53785	U002	8.00 x	22.00 x	— x	8.00 x	—	53821	U031	9.00 x	17.00 x	— x	4.00 x	—
50891	U	8.00 x	22.00 x	— x	10.00 x	—	53822	U001	9.00 x	17.00 x	— x	6.00 x	—
3368	C	8.00 x	22.50 x	— x	7.00 x	—	53823	U002	9.00 x	17.00 x	— x	6.00 x	—
53786	U001	8.00 x	24.00 x	— x	6.00 x	—	53824	U007	9.00 x	17.00 x	— x	8.00 x	—
53787	U002	8.00 x	24.00 x	— x	6.00 x	—	53825	U008	9.00 x	17.00 x	— x	8.00 x	—





Cód	Mod	Di x	De x	Esp. x	Ha1 x	Ha2	Cód	Mod	Di x	De x	Esp. x	Ha1 x	Ha2
50004	U031	9.00 x	19.00 x	— x	5.50 x	—	3040	C	9.52 x	22.22 x	2.80 x	15.87 x	—
53826	U001	9.00 x	19.00 x	— x	6.00 x	—	3137	C	9.52 x	32.00 x	— x	10.00 x	—
53827	U002	9.00 x	19.00 x	— x	6.00 x	—	3023	C	9.52 x	44.45 x	4.00 x	12.70 x	—
52967	U	9.00 x	19.00 x	— x	8.00 x	—	53850	U002	9.53 x	14.29 x	— x	3.18 x	—
52967	U002	9.00 x	19.00 x	— x	8.00 x	—	53851	U002	9.53 x	15.88 x	— x	3.18 x	—
53828	U031	9.00 x	19.00 x	— x	8.00 x	—	53852	U019	9.53 x	15.88 x	— x	3.18 x	—
—	CH	9.00 x	19.00 x	— x	22.00 x	—	51392	U	9.53 x	15.88 x	— x	6.35 x	—
52472	U002	9.00 x	20.00 x	— x	5.50 x	—	53853	U002	9.53 x	19.05 x	— x	3.97 x	—
53829	U001	9.00 x	20.00 x	— x	8.00 x	—	53854	U004	9.53 x	22.23 x	— x	7.94 x	—
53830	U002	9.00 x	20.00 x	— x	8.00 x	—	—	CH	9.53 x	22.23 x	— x	25.00 x	—
3340	C	9.00 x	21.04 x	— x	12.00 x	—	59226	U	9.53 x	25.40 x	— x	7.94 x	—
51535	U002	9.00 x	22.00 x	— x	8.00 x	—	53451	U04A	9.53 x	25.40 x	— x	7.94 x	—
53831	U002	9.00 x	22.00 x	— x	8.00 x	—	3266	C	9.60 x	101.80 x	3.00 x	11.00 x	—
53832	U001	9.00 x	23.00 x	— x	9.00 x	—	50133	U002	9.80 x	15.30 x	— x	4.50 x	—
53833	U002	9.00 x	23.00 x	— x	9.00 x	—	50992	U067	9.80 x	21.70 x	— x	8.90 x	7.80
53834	U002	9.00 x	23.00 x	— x	9.00 x	—	53855	U002	9.92 x	14.68 x	— x	5.16 x	—
3465	C	9.00 x	25.40 x	3.00 x	14.50 x	—	50576	U034	10.00 x	13.50 x	— x	2.30 x	—
3408	C	9.00 x	27.00 x	— x	10.00 x	—	53256	U027	10.00 x	14.00 x	— x	7.00 x	—
3459	C	9.00 x	35.00 x	— x	2.00 x	—	52150	U	10.00 x	14.50 x	— x	4.50 x	4.00
3459	C	9.00 x	35.00 x	2.00 x	8.00 x	—	51311	U006	10.00 x	15.00 x	— x	3.50 x	2.50
3459	C	9.00 x	35.00 x	— x	8.00 x	—	53856	U001	10.00 x	15.00 x	— x	4.00 x	—
51518	U	9.05 x	17.70 x	— x	3.17 x	—	53857	U002	10.00 x	15.00 x	— x	4.00 x	—
3405	C	9.12 x	12.70 x	— x	4.76 x	—	53859	U002	10.00 x	15.00 x	— x	5.00 x	—
50025	U102	9.20 x	16.80 x	— x	6.35 x	—	53860	U007	10.00 x	15.00 x	— x	5.00 x	—
53835	U001	9.20 x	57.50 x	— x	9.50 x	—	53861	U008	10.00 x	15.00 x	— x	5.00 x	—
53836	U002	9.20 x	57.50 x	— x	9.50 x	—	53858	U04A	10.00 x	15.00 x	— x	5.00 x	—
53837	U002	9.40 x	16.70 x	— x	4.00 x	—	52147	U	10.00 x	15.00 x	— x	6.00 x	—
50961	U002	9.40 x	20.70 x	— x	7.00 x	—	52111	U	10.00 x	15.70 x	— x	5.50 x	—
53838	U004	9.40 x	23.80 x	— x	10.00 x	—	51900	U019	10.00 x	15.80 x	— x	6.00 x	—
53839	U002	9.50 x	14.50 x	— x	3.00 x	—	53863	U	10.00 x	16.00 x	— x	2.50 x	3.00
53840	U007	9.50 x	14.50 x	— x	3.00 x	—	53864	U004	10.00 x	16.00 x	— x	2.50 x	3.00
53841	U	9.50 x	16.00 x	— x	4.00 x	—	50022	U008	10.00 x	16.00 x	— x	3.00 x	2.50
53842	U002	9.50 x	16.50 x	— x	4.00 x	—	52754	U003	10.00 x	16.00 x	— x	3.50 x	—
8273	V	9.50 x	18.00 x	— x	3.50 x	—	53865	U007	10.00 x	16.00 x	— x	3.50 x	—
F10456	J	9.50 x	18.00 x	— x	3.70 x	5.00	50245	U004	10.00 x	16.00 x	— x	4.00 x	—
52407	U	9.50 x	18.00 x	— x	4.50 x	—	52944	U008	10.00 x	16.00 x	— x	4.00 x	—
53843	U005	9.50 x	18.00 x	— x	4.50 x	—	51309	U031	10.00 x	16.00 x	— x	4.00 x	—
53844	U006	9.50 x	18.00 x	— x	5.50 x	—	53866	U004	10.00 x	16.00 x	— x	4.30 x	—
3539	C	9.50 x	19.05 x	2.50 x	6.00 x	—	53867	U001	10.00 x	16.00 x	— x	5.00 x	—
6114	CH	9.50 x	20.00 x	— x	20.00 x	—	53868	U002	10.00 x	16.00 x	— x	5.00 x	—
53845	U004	9.50 x	21.50 x	— x	7.50 x	—	50727	U	10.00 x	16.00 x	— x	5.50 x	—
8058	V	9.50 x	22.00 x	— x	4.00 x	—	52515	U04A	10.00 x	16.00 x	— x	5.80 x	—
53846	U001	9.50 x	22.00 x	— x	5.50 x	—	55604	U04A	10.00 x	16.00 x	— x	5.80 x	—
6328	CH	9.50 x	22.20 x	— x	30.16 x	—	53157	U001	10.00 x	16.00 x	— x	6.00 x	—
52220	U	9.50 x	25.40 x	— x	9.80 x	5.20	51387	U026	10.00 x	16.00 x	— x	6.00 x	—
50310	U031	9.50 x	27.50 x	— x	9.00 x	—	52461	U013	10.00 x	16.00 x	— x	7.00 x	—
3246	C	9.50 x	31.50 x	3.00 x	10.00 x	—	55547	UL	10.00 x	16.40 x	— x	5.00 x	5.80
3071	C	9.50 x	65.00 x	5.00 x	14.00 x	—	53869	U005	10.00 x	16.50 x	— x	4.00 x	—
3457	C	9.50 x	67.00 x	4.00 x	21.00 x	—	50005	U002	10.00 x	17.00 x	— x	4.00 x	—
50400	U004	9.52 x	14.29 x	— x	4.76 x	—	51937	U031	10.00 x	17.00 x	— x	5.00 x	—
51392	U	9.52 x	15.87 x	— x	3.17 x	—	53870	U001	10.00 x	17.00 x	— x	6.00 x	—
50744	U	9.52 x	15.87 x	— x	3.17 x	—	53871	U002	10.00 x	17.00 x	— x	6.00 x	—
50744	U	9.52 x	15.87 x	— x	3.17 x	—	USINADO	V	10.00 x	18.00 x	— x	3.20 x	—
51774	U001	9.52 x	15.87 x	— x	3.17 x	—	53872	U001	10.00 x	18.00 x	— x	4.00 x	—
50436	U002	9.52 x	15.87 x	— x	3.17 x	—	51895	U	10.00 x	18.00 x	— x	5.00 x	—
50436	U002	9.52 x	15.87 x	— x	3.17 x	—	53873	U002	10.00 x	18.00 x	— x	5.00 x	—
50228	U008	9.52 x	15.87 x	— x	3.17 x	—	51174	U006	10.00 x	18.00 x	— x	5.40 x	3.50
50334	U008	9.52 x	15.87 x	— x	3.17 x	—	51310	U006	10.00 x	18.00 x	— x	5.50 x	3.50
53848	U	9.52 x	15.87 x	— x	3.97 x	—	50255	U015	10.00 x	18.00 x	— x	5.50 x	—
50678	U002	9.52 x	17.46 x	— x	6.35 x	—	52505	U	10.00 x	18.00 x	— x	6.00 x	—
53849	U001	9.52 x	19.05 x	— x	3.96 x	—	53874	U004	10.00 x	18.00 x	— x	6.00 x	—
50388	U002	9.52 x	19.05 x	— x	4.00 x	—	53100	U008	10.00 x	18.00 x	— x	6.00 x	—
50404	U002	9.52 x	19.05 x	— x	4.37 x	—	51813	U04A	10.00 x	18.00 x	— x	6.00 x	—
51146	U	9.52 x	19.05 x	— x	4.76 x	—	51813	U04A	10.00 x	18.00 x	— x	6.00 x	—
8118	V	9.52 x	19.05 x	— x	4.76 x	—	51813	U04A	10.00 x	18.00 x	— x	6.00 x	—
—	U04A	9.52 x	19.05 x	— x	7.94 x	—	53100	U099	10.00 x	18.00 x	— x	6.00 x	—
6006	CH	9.52 x	19.05 x	— x	15.87 x	—	53875	U001	10.00 x	18.00 x	— x	8.00 x	—



Cód	Mod	Di x	De x	Esp. x	Ha1 x	Ha2	Cód	Mod	Di x	De x	Esp. x	Ha1 x	Ha2
53876	U002	10.00 x	18.00 x	— x	8.00 x	—	3036	C	10.00 x	45.00 x	3.00 x	15.00 x	—
53877	U007	10.00 x	18.00 x	— x	8.00 x	—	3064	C	10.00 x	46.00 x	3.00 x	15.00 x	—
53878	U008	10.00 x	18.00 x	— x	8.00 x	—	3008	C	10.00 x	55.00 x	3.00 x	20.00 x	—
53879	U005	10.00 x	18.00 x	— x	13.50 x	—	3523	C	10.00 x	64.00 x	— x	16.00 x	—
53880	U006	10.00 x	18.00 x	— x	13.50 x	—	3031	C	10.00 x	67.70 x	3.10 x	20.00 x	—
6416	CH	10.00 x	18.00 x	— x	17.00 x	—	3012	C	10.00 x	70.00 x	3.00 x	20.00 x	—
—	CH	10.00 x	19.00 x	— x	20.50 x	—	3017	C	10.00 x	72.00 x	3.50 x	20.00 x	—
53881	U	10.00 x	19.10 x	— x	5.00 x	6.00	3013	C	10.00 x	79.00 x	3.30 x	20.00 x	—
50475	U037	10.00 x	19.10 x	— x	6.00 x	5.00	3051	C	10.00 x	95.00 x	3.00 x	20.00 x	—
55607	U002	10.00 x	20.00 x	— x	5.00 x	—	53268	U031	10.00 x	102.00 x	— x	10.00 x	—
53883	U006	10.00 x	20.00 x	— x	7.00 x	—	53268	U031	10.00 x	102.00 x	— x	10.00 x	—
51162	U004	10.00 x	20.00 x	— x	8.00 x	—	3535	C001	10.00 x	115.00 x	— x	11.80 x	—
53884	U004	10.00 x	20.00 x	— x	8.00 x	—	3073	C	10.00 x	120.00 x	3.00 x	20.00 x	—
52659	U006	10.00 x	20.00 x	— x	8.00 x	—	3080	C	10.00 x	124.00 x	3.00 x	20.00 x	—
50248	U041	10.00 x	20.00 x	— x	8.00 x	—	3083	C	10.00 x	140.00 x	3.50 x	35.00 x	—
53885	U007	10.00 x	20.00 x	— x	8.50 x	—	3084	C	10.00 x	143.00 x	3.50 x	20.00 x	—
53886	U008	10.00 x	20.00 x	— x	8.50 x	—	3528	C	10.00 x	198.00 x	— x	30.00 x	—
53887	U002	10.00 x	20.00 x	— x	9.00 x	—	3094	C	10.00 x	222.00 x	4.00 x	30.00 x	—
6359	CH	10.00 x	20.00 x	— x	12.50 x	—	51449	U	10.20 x	14.20 x	— x	3.00 x	—
6361	CH	10.00 x	20.00 x	— x	16.50 x	—	59445	U	10.20 x	16.30 x	— x	4.60 x	—
6401	CH	10.00 x	20.00 x	— x	30.00 x	—	59449	U	10.20 x	17.80 x	— x	6.00 x	—
52206	U053	10.00 x	20.70 x	— x	4.00 x	—	52505	U011	10.30 x	18.85 x	— x	5.40 x	—
53888	U001	10.00 x	21.50 x	— x	6.50 x	—	53918	U005	10.32 x	17.07 x	— x	10.32 x	—
8129	V	10.00 x	22.00 x	— x	4.20 x	—	59312	U006	10.40 x	17.85 x	— x	5.90 x	—
51778	U019	10.00 x	22.00 x	— x	6.00 x	—	53919	U002	10.50 x	16.00 x	— x	6.00 x	—
53889	U019	10.00 x	22.00 x	— x	6.00 x	—	50250	U031	10.50 x	16.00 x	— x	6.00 x	—
50020	U003	10.00 x	22.00 x	— x	6.50 x	—	55668	UL	10.50 x	17.00 x	— x	4.00 x	5.00
53890	U005	10.00 x	22.00 x	— x	7.00 x	—	53920	U001	10.50 x	18.50 x	— x	4.50 x	—
50452	U089	10.00 x	22.00 x	— x	7.00 x	—	53921	U003	10.50 x	19.00 x	— x	4.00 x	—
53892	U004	10.00 x	22.00 x	— x	8.00 x	—	53922	U003	10.50 x	19.00 x	— x	4.50 x	—
50881	U046	10.00 x	22.00 x	— x	8.00 x	6.00	53923	U002	10.50 x	19.50 x	— x	4.00 x	—
53893	U007	10.00 x	22.00 x	— x	9.00 x	—	53924	U003	10.50 x	21.00 x	— x	5.00 x	—
53894	U008	10.00 x	22.00 x	— x	9.00 x	—	53099	U	10.50 x	22.00 x	— x	6.00 x	—
50017	U021	10.00 x	22.00 x	— x	9.00 x	8.00	53099	U001	10.50 x	22.00 x	— x	6.00 x	—
51690	U	10.00 x	23.00 x	— x	6.50 x	—	53317	U029	10.50 x	27.80 x	— x	9.50 x	—
51163	U002	10.00 x	23.00 x	— x	6.50 x	—	53925	U004	10.60 x	19.70 x	— x	4.10 x	—
53895	U002	10.00 x	23.00 x	— x	12.00 x	—	59339	U007	10.70 x	19.00 x	— x	3.90 x	4.60
52146	U019	10.00 x	24.50 x	— x	3.70 x	—	50771	U026	10.70 x	19.00 x	— x	4.50 x	—
53896	U001	10.00 x	25.00 x	— x	6.00 x	—	52029	U004	11.00 x	16.00 x	— x	3.00 x	—
53897	U002	10.00 x	25.00 x	— x	6.00 x	—	52098	U	11.00 x	16.00 x	— x	4.00 x	—
53898	U002	10.00 x	25.00 x	— x	8.00 x	—	53926	U002	11.00 x	16.00 x	— x	4.00 x	—
52357	U019	10.00 x	25.00 x	— x	8.00 x	—	52557	U	11.00 x	16.00 x	— x	6.00 x	—
53899	U004	10.00 x	25.00 x	— x	10.00 x	—	52815	U	11.00 x	16.30 x	— x	4.50 x	3.00
53900	U001	10.00 x	26.00 x	— x	8.00 x	—	52815	U	11.00 x	16.30 x	— x	4.50 x	—
53901	U002	10.00 x	26.00 x	— x	8.00 x	—	53102	U012	11.00 x	17.00 x	— x	4.80 x	—
53902	U019	10.00 x	26.00 x	— x	8.00 x	—	53506	U031	11.00 x	18.00 x	— x	4.00 x	—
53903	U001	10.00 x	27.00 x	— x	10.00 x	—	53927	U006	11.00 x	18.00 x	— x	5.50 x	—
52099	U002	10.00 x	27.00 x	— x	10.00 x	—	52363	U009	11.00 x	18.30 x	— x	4.20 x	3.10
53904	U002	10.00 x	27.00 x	— x	10.00 x	—	50009	U006	11.00 x	18.50 x	— x	4.20 x	—
53905	U001	10.00 x	27.00 x	— x	12.00 x	—	52161	U002	11.00 x	18.50 x	— x	5.60 x	—
53906	U002	10.00 x	27.00 x	— x	12.00 x	—	59259	U006	11.00 x	18.50 x	— x	6.00 x	—
53907	U001	10.00 x	28.00 x	— x	8.00 x	—	53928	U001	11.00 x	19.00 x	— x	4.00 x	—
53908	U002	10.00 x	28.00 x	— x	8.00 x	—	53929	U002	11.00 x	19.00 x	— x	4.00 x	—
53909	U001	10.00 x	28.00 x	— x	8.50 x	—	53930	U001	11.00 x	19.00 x	— x	4.50 x	—
53910	U002	10.00 x	28.00 x	— x	8.50 x	—	53931	U019	11.00 x	19.00 x	— x	6.00 x	—
53911	U001	10.00 x	28.00 x	— x	9.00 x	—	53117	U	11.00 x	20.00 x	— x	6.10 x	—
53912	U002	10.00 x	28.00 x	— x	9.00 x	—	53117	U	11.00 x	20.00 x	— x	6.80 x	—
52882	U	10.00 x	28.00 x	— x	9.50 x	—	53932	U001	11.00 x	21.00 x	— x	6.00 x	—
52882	U	10.00 x	28.00 x	— x	9.50 x	—	—	CH	11.00 x	21.00 x	— x	22.00 x	—
50002	U018	10.00 x	28.00 x	— x	10.00 x	—	51439	U002	11.00 x	21.80 x	— x	6.20 x	5.80
53913	U001	10.00 x	30.00 x	— x	10.00 x	—	53933	U001	11.00 x	22.00 x	— x	8.00 x	—
53914	U002	10.00 x	30.00 x	— x	10.00 x	—	53934	U002	11.00 x	22.00 x	— x	8.00 x	—
53915	U019	10.00 x	30.00 x	— x	10.00 x	—	53935	U001	11.00 x	23.00 x	— x	6.00 x	—
53916	U001	10.00 x	32.00 x	— x	9.50 x	—	53936	U002	11.00 x	23.00 x	— x	6.00 x	—
53917	U002	10.00 x	32.00 x	— x	10.00 x	—	8060	V	11.00 x	23.00 x	— x	6.00 x	—
55692	U002	10.00 x	40.00 x	— x	10.00 x	—	53937	U004	11.00 x	24.00 x	— x	10.00 x	—
55693	U002	10.00 x	40.00 x	— x	10.00 x	—	50856	U019	11.00 x	24.50 x	— x	11.00 x	—



Cód	Mod	Di x	De x	Esp. x	Ha1 x	Ha2	Cód	Mod	Di x	De x	Esp. x	Ha1 x	Ha2
51621	U013	11.00 x	25.00 x	— x	6.50 x	—	50587	U031	12.00 x	18.00 x	— x	4.00 x	—
53938	U001	11.00 x	25.00 x	— x	7.00 x	—	8189	V	12.00 x	18.00 x	— x	4.00 x	—
53939	U002	11.00 x	25.00 x	— x	7.00 x	—	51808	U	12.00 x	18.00 x	— x	4.50 x	4.00
53940	U001	11.00 x	25.00 x	— x	8.00 x	—	51612	U001	12.00 x	18.00 x	— x	4.50 x	—
53941	U002	11.00 x	25.00 x	— x	8.00 x	—	53965	U002	12.00 x	18.00 x	— x	5.00 x	—
53942	U001	11.00 x	26.00 x	— x	8.00 x	—	50058	U031	12.00 x	18.00 x	— x	5.00 x	—
53943	U002	11.00 x	26.00 x	— x	8.00 x	—	53023	U04A	12.00 x	18.00 x	— x	5.00 x	—
—	CH	11.00 x	28.50 x	— x	33.00 x	—	51664	U	12.00 x	18.00 x	— x	5.50 x	—
3293	C	11.00 x	35.00 x	— x	8.00 x	—	50199	U008	12.00 x	18.00 x	— x	5.50 x	—
3453	C	11.00 x	54.00 x	5.00 x	15.30 x	—	53966	U002	12.00 x	18.00 x	— x	6.00 x	—
53077	U	11.10 x	16.00 x	— x	3.90 x	—	53016	U002	12.00 x	18.00 x	— x	6.00 x	—
53077	U	11.10 x	16.00 x	— x	5.30 x	—	51296	U013	12.00 x	18.00 x	— x	6.00 x	5.00
53012	U002	11.10 x	17.40 x	— x	3.18 x	—	53016	U031	12.00 x	18.00 x	— x	6.00 x	—
53012	U002	11.10 x	17.40 x	— x	3.18 x	—	53061	U011	12.00 x	18.30 x	— x	5.80 x	—
53012	U002	11.10 x	17.40 x	— x	3.18 x	—	50731	U005	12.00 x	19.00 x	— x	4.50 x	4.00
51491	U003	11.10 x	17.45 x	— x	6.35 x	—	50731	U005	12.00 x	19.00 x	— x	4.50 x	—
51729	U	11.10 x	25.40 x	— x	8.00 x	—	53967	U006	12.00 x	19.00 x	— x	4.50 x	—
51465	U003	11.11 x	14.29 x	— x	6.35 x	—	55580	UL	12.00 x	19.00 x	— x	4.50 x	5.00
53945	U001	11.11 x	15.47 x	— x	4.37 x	—	53968	U	12.00 x	19.00 x	— x	5.00 x	6.00
53946	U019	11.11 x	17.46 x	— x	4.76 x	—	53969	U	12.00 x	19.00 x	— x	5.00 x	6.00
50110	U002	11.11 x	19.05 x	— x	4.76 x	—	53970	U031	12.00 x	19.00 x	— x	5.00 x	—
53947	U019	11.11 x	19.05 x	— x	4.76 x	—	50036	U007	12.00 x	19.00 x	— x	6.00 x	5.00
50418	U002	11.11 x	19.05 x	— x	5.56 x	—	53971	U002	12.00 x	19.00 x	— x	7.50 x	—
53948	U007	11.11 x	20.64 x	— x	11.11 x	—	51044	U031	12.00 x	19.00 x	— x	7.50 x	—
—	CH	11.11 x	20.64 x	— x	16.00 x	—	51298	U	12.00 x	19.00 x	— x	8.00 x	6.50
3322	C	11.11 x	25.40 x	— x	6.35 x	—	6460	CH	12.00 x	19.00 x	— x	20.00 x	—
3041	C	11.11 x	25.40 x	1.78 x	11.91 x	—	55580	UL	12.00 x	19.50 x	— x	4.00 x	5.50
53949	U001	11.11 x	28.57 x	— x	12.00 x	—	55580	UL	12.00 x	19.50 x	— x	4.00 x	5.50
53950	U002	11.11 x	28.58 x	— x	12.00 x	—	53972	U008	12.00 x	20.00 x	— x	3.80 x	—
3015	C	11.11 x	31.75 x	3.17 x	6.35 x	—	53973	U001	12.00 x	20.00 x	— x	4.00 x	—
3180	C	11.11 x	34.92 x	3.17 x	7.14 x	—	8360	V	12.00 x	20.00 x	— x	4.00 x	—
59240	U004	11.25 x	17.80 x	— x	4.10 x	—	50649	U	12.00 x	20.00 x	— x	4.50 x	—
59242	U004	11.25 x	17.80 x	— x	4.30 x	—	53974	U002	12.00 x	20.00 x	— x	5.00 x	—
53102	U006	11.30 x	17.50 x	— x	3.35 x	—	51995	U	12.00 x	20.00 x	— x	5.50 x	—
3518	C	11.30 x	22.00 x	— x	6.30 x	—	51798	U	12.00 x	20.00 x	— x	5.50 x	—
3116	C	11.40 x	38.10 x	3.00 x	10.00 x	—	55572	U004	12.00 x	20.00 x	— x	5.50 x	—
53951	U002	11.50 x	16.50 x	— x	3.50 x	—	51995	U005	12.00 x	20.00 x	— x	5.50 x	3.50
53952	U002	11.50 x	16.50 x	— x	5.00 x	—	50547	U006	12.00 x	20.00 x	— x	5.50 x	—
53365	U008	11.50 x	17.40 x	— x	2.62 x	—	52476	U017	12.00 x	20.00 x	— x	5.50 x	—
51524	U031	11.50 x	18.00 x	— x	4.00 x	—	51618	U028	12.00 x	20.00 x	— x	5.50 x	4.50
53953	U001	11.50 x	18.00 x	— x	5.00 x	—	53379	U	12.00 x	20.00 x	— x	6.00 x	8.50
53954	U002	11.50 x	18.00 x	— x	5.00 x	—	53975	U019	12.00 x	20.00 x	— x	6.00 x	—
51848	U003	11.50 x	19.60 x	— x	3.50 x	—	52518	U002	12.00 x	20.00 x	— x	8.00 x	—
55596	UL	11.50 x	20.00 x	— x	4.00 x	5.50	53976	U002	12.00 x	20.00 x	— x	8.00 x	—
53005	UL	11.50 x	20.00 x	— x	4.50 x	—	53977	U004	12.00 x	20.00 x	— x	8.00 x	—
53005	UL	11.50 x	20.00 x	— x	6.00 x	4.50	53978	U002	12.00 x	20.00 x	— x	9.00 x	—
52935	U	11.50 x	25.40 x	— x	7.50 x	—	53979	U007	12.00 x	20.00 x	— x	13.50 x	—
50065	U006	11.60 x	18.50 x	— x	4.00 x	—	53980	U008	12.00 x	20.00 x	— x	13.50 x	—
50348	U007	11.91 x	17.43 x	— x	3.17 x	—	53344	U008	12.00 x	20.50 x	— x	4.50 x	5.50
50380	U004	11.91 x	17.46 x	— x	3.17 x	—	59377	UL	12.00 x	20.50 x	— x	4.50 x	5.50
50348	U007	11.91 x	17.46 x	— x	3.17 x	—	53981	U005	12.00 x	20.50 x	— x	5.50 x	—
53955	U002	11.91 x	17.46 x	— x	3.53 x	—	53498	U005	12.00 x	20.50 x	— x	5.50 x	—
53956	U007	11.91 x	18.65 x	— x	4.76 x	—	53982	U001	12.00 x	20.50 x	— x	6.00 x	—
50112	U031	11.91 x	19.05 x	— x	4.76 x	—	52248	U	12.00 x	20.50 x	— x	8.00 x	—
53957	U007	11.91 x	19.05 x	— x	5.40 x	—	51332	U	12.00 x	22.00 x	— x	4.50 x	—
53958	U008	11.91 x	19.05 x	— x	5.56 x	—	53983	U002	12.00 x	22.00 x	— x	5.00 x	—
50516	U003	11.91 x	25.40 x	— x	7.14 x	—	52089	U002	12.00 x	22.00 x	— x	5.00 x	—
53397	U031	12.00 x	15.50 x	— x	4.00 x	4.80	52089	U003	12.00 x	22.00 x	— x	5.00 x	—
53959	U007	12.00 x	17.00 x	— x	3.00 x	—	50283	U090	12.00 x	22.00 x	— x	5.00 x	—
53960	U007	12.00 x	17.00 x	— x	4.50 x	—	8152	V	12.00 x	22.00 x	— x	5.00 x	—
53961	U008	12.00 x	17.00 x	— x	4.50 x	—	52385	U017	12.00 x	22.00 x	— x	6.00 x	—
53962	U002	12.00 x	17.50 x	— x	6.00 x	—	52027	U002	12.00 x	22.00 x	— x	7.00 x	—
55627	U	12.00 x	17.70 x	— x	2.70 x	—	53984	U002	12.00 x	22.00 x	— x	7.00 x	—
53360	U	12.00 x	18.00 x	— x	2.50 x	—	53985	U005	12.00 x	22.00 x	— x	7.00 x	—
53509	U002	12.00 x	18.00 x	— x	2.50 x	—	53986	U006	12.00 x	22.00 x	— x	7.00 x	—
53963	U007	12.00 x	18.00 x	— x	3.20 x	—	53987	U005	12.00 x	22.00 x	— x	7.50 x	—
53964	U002	12.00 x	18.00 x	— x	4.00 x	—	53988	U006	12.00 x	22.00 x	— x	7.50 x	—



Cód	Mod	Di x	De x	Esp. x	Ha1 x	Ha2	Cód	Mod	Di x	De x	Esp. x	Ha1 x	Ha2
50838	U	12.00 x	22.00 x	— x	8.00 x	—	52373	U	12.20 x	20.20 x	— x	8.20 x	—
53989	U002	12.00 x	22.00 x	— x	8.00 x	—	53281	U002	12.20 x	27.80 x	— x	12.00 x	—
50838	U004	12.00 x	22.00 x	— x	8.00 x	—	52876	U008	12.30 x	18.00 x	— x	6.30 x	—
53517	U04A	12.00 x	22.00 x	— x	8.00 x	—	51586	U	12.30 x	19.30 x	— x	3.20 x	—
8312	V	12.00 x	22.00 x	— x	8.00 x	—	53504	U	12.30 x	20.20 x	— x	4.40 x	—
6110	CH	12.00 x	22.00 x	— x	20.00 x	—	54029	U002	12.50 x	17.50 x	— x	2.50 x	—
—	CH	12.00 x	22.00 x	— x	22.00 x	—	50666	U005	12.50 x	17.50 x	— x	3.40 x	—
53990	U	12.00 x	22.30 x	— x	6.50 x	7.50	50211	U005	12.50 x	17.90 x	— x	5.50 x	—
50478	U037	12.00 x	22.30 x	— x	7.50 x	6.50	50569	U003	12.50 x	18.00 x	— x	2.00 x	—
53991	U001	12.00 x	23.00 x	— x	5.50 x	—	3099	C	12.50 x	18.00 x	1.00 x	6.50 x	—
53241	U	12.00 x	23.20 x	— x	4.80 x	—	51434	U	12.50 x	18.50 x	— x	3.00 x	—
53241	U	12.00 x	23.20 x	— x	6.30 x	—	54030	U002	12.50 x	18.50 x	— x	3.00 x	—
52453	U	12.00 x	24.00 x	— x	6.00 x	—	54031	U007	12.50 x	18.50 x	— x	5.50 x	—
53992	U002	12.00 x	24.00 x	— x	6.00 x	—	52899	U	12.50 x	19.00 x	— x	3.00 x	—
53993	U019	12.00 x	24.00 x	— x	6.00 x	—	52870	U	12.50 x	19.00 x	— x	3.30 x	2.70
8274	V	12.00 x	24.00 x	— x	6.00 x	—	52899	U	12.50 x	19.00 x	— x	4.50 x	—
53994	U001	12.00 x	24.00 x	— x	9.00 x	—	52899	U047	12.50 x	19.00 x	— x	4.50 x	3.00
53995	U002	12.00 x	24.00 x	— x	9.00 x	—	54032	U005	12.50 x	20.00 x	— x	9.00 x	—
53233	U004	12.00 x	24.00 x	— x	10.00 x	—	50656	U	12.50 x	20.50 x	— x	5.00 x	—
53996	U002	12.00 x	24.00 x	— x	11.50 x	—	54033	U004	12.50 x	21.00 x	— x	6.00 x	—
—	C	12.00 x	24.00 x	— x	15.00 x	—	3325	C	12.50 x	22.00 x	— x	8.00 x	—
—	CH	12.00 x	24.00 x	— x	32.50 x	—	3325	C	12.50 x	22.00 x	— x	8.00 x	—
8173	V	12.00 x	25.00 x	— x	4.00 x	—	53251	U	12.50 x	22.00 x	— x	8.00 x	—
55614	U002	12.00 x	25.00 x	— x	5.00 x	—	53251	U006	12.50 x	22.00 x	— x	8.00 x	—
52749	U001	12.00 x	25.00 x	— x	8.00 x	—	54034	U005	12.50 x	22.70 x	— x	13.00 x	—
53997	U004	12.00 x	25.00 x	— x	10.00 x	—	54035	U006	12.50 x	22.70 x	— x	13.00 x	—
51660	U	12.00 x	26.00 x	— x	5.00 x	—	F8097	W	12.50 x	25.00 x	— x	4.00 x	3.50
51868	U035	12.00 x	26.00 x	— x	5.00 x	—	54036	U002	12.50 x	25.00 x	— x	6.00 x	—
52623	U	12.00 x	26.00 x	— x	8.00 x	—	51278	U002	12.50 x	25.50 x	— x	6.50 x	—
53999	U001	12.00 x	26.00 x	— x	8.00 x	—	54037	U001	12.50 x	28.00 x	— x	13.00 x	—
54000	U007	12.00 x	26.00 x	— x	9.50 x	—	54038	U002	12.50 x	28.00 x	— x	13.00 x	—
50989	U004	12.00 x	26.00 x	— x	10.00 x	—	54039	U001	12.50 x	30.00 x	— x	10.00 x	—
54001	U004	12.00 x	26.00 x	— x	10.00 x	—	54040	U002	12.50 x	30.00 x	— x	10.00 x	—
54002	U007	12.00 x	26.00 x	— x	10.50 x	—	54041	U001	12.50 x	32.00 x	— x	12.00 x	—
54003	U008	12.00 x	26.00 x	— x	10.50 x	—	54042	U002	12.50 x	32.00 x	— x	12.00 x	—
54004	U001	12.00 x	26.00 x	— x	12.00 x	—	54043	U003	12.50 x	34.50 x	— x	8.00 x	—
54005	U002	12.00 x	26.00 x	— x	12.00 x	—	54044	U001	12.50 x	35.00 x	— x	12.00 x	—
54006	U001	12.00 x	28.00 x	— x	8.00 x	—	54045	U002	12.50 x	35.00 x	— x	12.00 x	—
54007	U002	12.00 x	28.00 x	— x	8.00 x	—	3369	C	12.50 x	38.00 x	— x	11.00 x	—
54008	U001	12.00 x	28.00 x	— x	9.00 x	—	—	C	12.50 x	47.60 x	— x	5.00 x	—
54009	U002	12.00 x	28.00 x	— x	9.00 x	—	3406	C	12.60 x	111.00 x	— x	9.00 x	—
54010	U001	12.00 x	28.00 x	— x	10.00 x	—	52114	U031	12.69 x	17.00 x	— x	4.80 x	—
54011	U002	12.00 x	28.00 x	— x	10.00 x	—	50264	U031	12.70 x	15.87 x	— x	3.17 x	—
54012	U019	12.00 x	28.00 x	— x	10.00 x	—	52976	U	12.70 x	17.46 x	— x	3.18 x	—
54013	U001	12.00 x	28.00 x	— x	26.00 x	—	52976	U007	12.70 x	17.46 x	— x	3.18 x	—
54014	U001	12.00 x	28.00 x	— x	26.00 x	—	51874	U007	12.70 x	17.80 x	— x	5.55 x	—
54015	U002	12.00 x	28.00 x	— x	26.00 x	—	55725	U04A	12.70 x	19.00 x	— x	6.50 x	—
54016	U001	12.00 x	30.00 x	— x	9.00 x	—	54046	U001	12.70 x	19.05 x	— x	2.38 x	—
54017	U002	12.00 x	30.00 x	— x	9.00 x	—	54047	U002	12.70 x	19.05 x	— x	2.38 x	—
6461	CH	12.00 x	30.00 x	— x	20.00 x	—	50163	U004	12.70 x	19.05 x	— x	3.17 x	—
3045	C	12.00 x	32.00 x	3.00 x	10.00 x	—	51482	U	12.70 x	19.05 x	— x	3.18 x	—
54018	U001	12.00 x	32.00 x	— x	10.00 x	—	53174	U	12.70 x	19.05 x	— x	3.18 x	—
54019	U002	12.00 x	32.00 x	— x	10.00 x	—	8342	V	12.70 x	19.05 x	— x	3.18 x	—
54020	U001	12.00 x	34.00 x	— x	10.00 x	—	53479	U002	12.70 x	19.05 x	— x	3.70 x	—
54021	U002	12.00 x	34.00 x	— x	10.00 x	—	50453	U031	12.70 x	19.05 x	— x	5.56 x	—
54022	U004	12.00 x	34.00 x	— x	10.00 x	—	8358	V	12.70 x	19.05 x	— x	5.56 x	—
54023	U019	12.00 x	35.00 x	— x	12.00 x	—	52002	U002	12.70 x	19.05 x	— x	6.35 x	—
54024	U001	12.00 x	35.00 x	— x	14.00 x	—	52002	U002	12.70 x	19.05 x	— x	6.35 x	—
54025	U002	12.00 x	35.00 x	— x	14.00 x	—	52656	U031	12.70 x	20.00 x	— x	4.00 x	—
54026	U001	12.00 x	36.00 x	— x	12.00 x	—	F9903	J	12.70 x	20.00 x	— x	5.50 x	6.40
54027	U002	12.00 x	36.00 x	— x	12.00 x	—	54049	U003	12.70 x	20.64 x	— x	4.76 x	—
52380	U001	12.00 x	40.00 x	— x	10.00 x	—	54050	U019	12.70 x	20.64 x	— x	5.56 x	—
54028	U002	12.00 x	40.00 x	— x	10.00 x	—	54051	U004	12.70 x	22.00 x	— x	10.00 x	—
3054	C	12.00 x	83.00 x	6.00 x	13.00 x	—	8146	V	12.70 x	22.20 x	— x	3.80 x	—
3426	C	12.00 x	86.00 x	4.00 x	12.70 x	—	59438	U04A	12.70 x	22.20 x	— x	7.95 x	—
3379	C	12.00 x	105.00 x	1.00 x	7.00 x	—	54052	U	12.70 x	22.22 x	— x	3.97 x	4.76
51145	U	12.15 x	23.80 x	— x	3.40 x	—	8199	V	12.70 x	22.22 x	— x	3.97 x	—





Cód	Mod	Di x	De x	Esp. x	Ha1 x	Ha2	Cód	Mod	Di x	De x	Esp. x	Ha1 x	Ha2
50747	U001	12.70 x	22.22 x	— x	4.76 x	—	54077	U001	13.00 x	30.00 x	— x	8.00 x	—
51876	U002	12.70 x	22.22 x	— x	4.76 x	—	54078	U002	13.00 x	30.00 x	— x	8.00 x	—
50510	U074	12.70 x	22.22 x	— x	4.76 x	3.97	51488	U002	13.00 x	30.00 x	— x	8.20 x	—
8032	V	12.70 x	22.22 x	— x	4.76 x	—	54079	U001	13.00 x	30.00 x	— x	10.00 x	—
8038	V	12.70 x	22.22 x	— x	4.76 x	—	54080	U002	13.00 x	30.00 x	— x	10.00 x	—
8032	V	12.70 x	22.22 x	— x	4.76 x	—	54081	U019	13.00 x	30.00 x	— x	10.00 x	—
54053	U004	12.70 x	22.23 x	— x	4.76 x	—	54082	U001	13.00 x	36.00 x	— x	10.00 x	—
54054	U019	12.70 x	22.23 x	— x	4.76 x	—	54083	U002	13.00 x	36.00 x	— x	10.00 x	—
51028	U	12.70 x	25.40 x	— x	4.00 x	—	54084	U001	13.00 x	40.00 x	— x	8.00 x	—
8288	V	12.70 x	25.40 x	— x	4.50 x	—	54085	U002	13.00 x	40.00 x	— x	8.00 x	—
54054	U002	12.70 x	25.40 x	— x	6.35 x	—	3464	C	13.00 x	42.80 x	4.00 x	12.00 x	—
53135	U006	12.70 x	25.40 x	— x	6.35 x	—	3276	C	13.00 x	50.00 x	3.00 x	11.00 x	—
50219	U031	12.70 x	25.40 x	— x	6.35 x	—	3349	C	13.00 x	57.00 x	4.00 x	16.00 x	—
52918	U	12.70 x	25.40 x	— x	9.00 x	—	—	C	13.00 x	80.00 x	— x	4.00 x	—
53044	U	12.70 x	25.40 x	— x	9.50 x	—	3455	C	13.00 x	101.00 x	— x	5.00 x	—
53044	U	12.70 x	25.40 x	— x	9.50 x	—	3455	C	13.00 x	101.00 x	— x	25.80 x	—
6010	CH	12.70 x	25.40 x	— x	21.40 x	—	3425	C	13.00 x	101.60 x	— x	5.00 x	—
6010	CH	12.70 x	25.40 x	— x	21.40 x	—	3425	C	13.00 x	101.60 x	— x	26.00 x	—
3194	C001	12.70 x	26.90 x	3.20 x	9.50 x	—	8343	V	13.20 x	29.00 x	— x	6.80 x	—
—	CH	12.70 x	28.58 x	— x	29.00 x	—	3451	C	13.20 x	112.50 x	5.00 x	20.00 x	—
55545	U	12.70 x	29.00 x	— x	10.00 x	—	53343	U002	13.30 x	19.30 x	— x	3.40 x	—
51515	U	12.70 x	30.00 x	— x	6.00 x	—	F3742	W	13.40 x	25.00 x	— x	4.10 x	5.30
3038	C	12.70 x	31.75 x	3.50 x	7.14 x	—	F13607	W	13.40 x	25.00 x	— x	5.30 x	6.10
3044	C	12.70 x	38.10 x	3.17 x	7.94 x	—	55735	UL	13.50 x	18.00 x	— x	3.50 x	4.80
3175	C	12.70 x	50.00 x	3.00 x	16.00 x	—	55687	U007	13.50 x	19.00 x	— x	2.75 x	3.40
3027	C	12.70 x	50.80 x	3.17 x	12.70 x	—	54086	U002	13.50 x	19.00 x	— x	3.50 x	—
3111	C	12.70 x	63.50 x	3.50 x	12.70 x	—	54087	U007	13.50 x	19.50 x	— x	6.30 x	—
54055	U002	13.00 x	17.00 x	— x	5.00 x	—	54089	U002	13.50 x	23.50 x	— x	6.00 x	—
52910	U001	13.00 x	18.00 x	— x	2.60 x	—	3162	C	13.50 x	24.50 x	— x	7.00 x	—
52910	U001	13.00 x	18.00 x	— x	2.60 x	—	3436	C	13.50 x	51.00 x	— x	15.00 x	—
51266	U	13.00 x	18.50 x	— x	3.00 x	—	54090	U002	13.70 x	20.00 x	— x	4.50 x	—
55646	U002	13.00 x	18.50 x	— x	3.80 x	—	50535	U091	13.80 x	22.50 x	— x	2.20 x	—
59435	U04A	13.00 x	19.00 x	— x	3.30 x	—	55726	U007	14.00 x	19.50 x	— x	3.30 x	4.00
54056	U031	13.00 x	19.00 x	— x	4.00 x	—	53142	U002	14.00 x	20.00 x	— x	2.50 x	—
54057	U001	13.00 x	20.00 x	— x	3.00 x	—	51562	U04A	14.00 x	20.00 x	— x	3.18 x	—
54058	U002	13.00 x	20.00 x	— x	3.00 x	—	54226	U	14.00 x	20.00 x	— x	4.00 x	4.70
54059	U006	13.00 x	20.00 x	— x	4.50 x	—	50492	U001	14.00 x	20.00 x	— x	4.00 x	—
54060	U001	13.00 x	20.00 x	— x	5.50 x	—	54223	U002	14.00 x	20.00 x	— x	4.00 x	—
54061	U002	13.00 x	20.00 x	— x	5.50 x	—	54224	U005	14.00 x	20.00 x	— x	4.00 x	—
54062	U007	13.00 x	20.00 x	— x	6.60 x	—	54225	U006	14.00 x	20.00 x	— x	4.00 x	—
54063	U008	13.00 x	20.00 x	— x	7.60 x	—	54227	U001	14.00 x	20.00 x	— x	4.50 x	—
3214	C	13.00 x	20.00 x	5.00 x	9.50 x	—	54228	U002	14.00 x	20.00 x	— x	4.50 x	—
—	CH	13.00 x	20.00 x	— x	26.00 x	—	50226	U077	14.00 x	20.00 x	— x	4.70 x	4.00
54064	U003	13.00 x	20.50 x	— x	5.50 x	—	52912	U004	14.00 x	20.00 x	— x	5.00 x	—
50067	U006	13.00 x	21.00 x	— x	4.60 x	—	59258	U004	14.00 x	20.00 x	— x	5.00 x	—
54065	U004	13.00 x	21.00 x	— x	5.00 x	—	52629	U007	14.00 x	20.00 x	— x	5.00 x	—
53217	U	13.00 x	21.00 x	— x	5.50 x	—	52912	U007	14.00 x	20.00 x	— x	5.00 x	—
54066	U002	13.00 x	21.00 x	— x	6.00 x	—	54229	U008	14.00 x	20.00 x	— x	5.00 x	—
54067	U005	13.00 x	21.00 x	— x	6.00 x	—	54230	U001	14.00 x	20.00 x	— x	6.00 x	—
53217	U	13.00 x	21.00 x	— x	8.00 x	—	54231	U004	14.00 x	20.00 x	— x	6.00 x	—
8028	V	13.00 x	21.60 x	— x	3.30 x	—	50995	U002	14.00 x	20.00 x	— x	8.00 x	—
54068	U019	13.00 x	22.00 x	— x	4.50 x	—	54231	U005	14.00 x	20.50 x	— x	4.50 x	—
53177	U017	13.00 x	22.00 x	— x	7.20 x	—	54232	U001	14.00 x	21.00 x	— x	5.00 x	—
54069	U004	13.00 x	22.00 x	— x	7.50 x	—	51787	U	14.00 x	22.00 x	— x	4.00 x	—
52750	U031	13.00 x	22.00 x	— x	7.90 x	—	52087	U	14.00 x	22.00 x	— x	4.00 x	—
53207	U	13.00 x	22.00 x	— x	75.00 x	—	54233	U031	14.00 x	22.00 x	— x	4.50 x	—
—	CH	13.00 x	23.00 x	— x	22.00 x	—	51934	U004	14.00 x	22.00 x	— x	5.00 x	—
54070	U001	13.00 x	24.00 x	— x	6.00 x	—	51187	U005	14.00 x	22.00 x	— x	5.00 x	4.00
54071	U002	13.00 x	24.00 x	— x	6.00 x	—	52506	U006	14.00 x	22.00 x	— x	5.50 x	—
8299	V	13.00 x	24.00 x	— x	6.00 x	—	50658	U	14.00 x	22.00 x	— x	6.00 x	5.00
54072	U001	13.00 x	25.00 x	— x	7.00 x	—	54234	U001	14.00 x	22.00 x	— x	6.00 x	—
54073	U004	13.00 x	25.00 x	— x	8.00 x	—	52429	U002	14.00 x	22.00 x	— x	6.00 x	—
54074	U001	13.00 x	25.50 x	— x	10.00 x	—	54235	U005	14.00 x	22.00 x	— x	7.00 x	—
6376	CH	13.00 x	25.60 x	— x	25.00 x	—	54236	U006	14.00 x	22.00 x	— x	7.00 x	—
—	CH	13.00 x	26.00 x	— x	29.00 x	—	54237	U001	14.00 x	22.00 x	— x	8.00 x	—
54075	U001	13.00 x	28.00 x	— x	9.00 x	—	54238	U002	14.00 x	22.00 x	— x	8.00 x	—
54076	U002	13.00 x	28.00 x	— x	9.00 x	—	54239	U006	14.00 x	22.50 x	— x	5.50 x	—



Cód	Mod	Di x	De x	Esp. x	Ha1 x	Ha2	Cód	Mod	Di x	De x	Esp. x	Ha1 x	Ha2
54240	U001	14.00 x	23.50 x	— x	12.00 x	—	50233	U031	14.29 x	19.05 x	— x	3.57 x	—
54241	U002	14.00 x	23.50 x	— x	12.00 x	—	54278	U006	14.29 x	20.64 x	— x	5.56 x	—
51866	U003	14.00 x	24.00 x	— x	4.80 x	—	54279	U007	14.29 x	20.64 x	— x	6.35 x	—
51740	U	14.00 x	24.00 x	— x	5.00 x	—	54280	U008	14.29 x	20.64 x	— x	6.35 x	—
51740	U005	14.00 x	24.00 x	— x	5.00 x	—	54281	U019	14.29 x	23.81 x	— x	4.76 x	—
54242	U005	14.00 x	24.00 x	— x	5.00 x	—	F3875	J	14.29 x	23.81 x	— x	7.14 x	9.52
54243	U006	14.00 x	24.00 x	— x	5.00 x	—	6407	CH	14.29 x	23.81 x	— x	10.00 x	—
54244	U002	14.00 x	24.00 x	— x	7.00 x	—	8200	V	14.29 x	26.99 x	— x	4.76 x	—
51723	U	14.00 x	24.00 x	— x	7.30 x	—	8130	V	14.29 x	28.57 x	— x	6.35 x	—
54245	U004	14.00 x	24.00 x	— x	8.00 x	—	8130	V	14.29 x	28.57 x	— x	6.35 x	—
54246	U001	14.00 x	24.00 x	— x	20.00 x	—	54282	U	14.29 x	40.08 x	— x	7.94 x	9.52
54247	U002	14.00 x	24.00 x	— x	20.00 x	—	50563	U103	14.29 x	40.08 x	— x	9.52 x	7.94
—	CH	14.00 x	24.00 x	— x	22.00 x	—	54283	U003	14.29 x	50.80 x	— x	6.35 x	—
F8459	J	14.00 x	24.50 x	— x	7.50 x	8.00	3222	C001	14.29 x	63.50 x	3.18 x	13.00 x	—
52097	U002	14.00 x	24.60 x	— x	6.60 x	—	55665	U004	14.30 x	20.50 x	— x	2.20 x	—
54248	U	14.00 x	25.00 x	— x	5.50 x	6.50	52104	U006	14.30 x	20.50 x	— x	6.40 x	—
50474	U002	14.00 x	25.00 x	— x	6.50 x	—	6408	CH	14.40 x	21.00 x	— x	15.00 x	—
50474	U037	14.00 x	25.00 x	— x	6.50 x	5.50	54284	U005	14.50 x	20.50 x	— x	4.50 x	—
51410	U	14.00 x	25.00 x	— x	7.00 x	—	50003	U005	14.50 x	20.50 x	— x	4.70 x	—
54249	U003	14.00 x	25.00 x	— x	7.00 x	—	50497	U019	14.50 x	20.50 x	— x	5.00 x	—
52862	U	14.00 x	25.00 x	— x	8.00 x	—	52110	U028	14.50 x	20.50 x	— x	6.10 x	4.50
54250	U001	14.00 x	25.00 x	— x	10.00 x	—	50295	U027	14.50 x	21.50 x	— x	2.50 x	—
54251	U002	14.00 x	25.00 x	— x	10.00 x	—	54285	U031	14.50 x	24.00 x	— x	5.00 x	—
54252	U001	14.00 x	25.40 x	— x	6.00 x	—	50062	U002	14.50 x	24.00 x	— x	5.50 x	—
54253	U002	14.00 x	25.40 x	— x	6.00 x	—	52450	U002	14.50 x	30.00 x	— x	8.20 x	—
54254	U001	14.00 x	26.00 x	— x	8.00 x	—	3374	C	14.50 x	31.50 x	— x	9.00 x	—
52733	U029	14.00 x	26.00 x	— x	8.00 x	—	3021	C	14.50 x	33.00 x	5.00 x	8.50 x	—
59347	U004	14.00 x	26.50 x	— x	5.00 x	—	54286	U003	14.50 x	36.00 x	— x	10.00 x	—
6452	CH	14.00 x	26.50 x	— x	15.00 x	—	51960	U	14.50 x	38.10 x	— x	9.50 x	—
50244	U011	14.00 x	27.00 x	— x	10.00 x	—	52934	U	14.50 x	40.00 x	— x	10.60 x	8.10
54255	U001	14.00 x	27.00 x	— x	12.00 x	—	3461	C	14.50 x	41.50 x	— x	4.00 x	—
54256	U002	14.00 x	27.00 x	— x	12.00 x	—	3461	C	14.50 x	41.50 x	4.00 x	11.00 x	—
—	CH	14.00 x	27.00 x	— x	29.00 x	—	3461	C	14.50 x	41.50 x	— x	11.00 x	—
54257	U004	14.00 x	28.00 x	— x	10.00 x	—	3469	C	14.50 x	72.50 x	4.50 x	14.50 x	—
54258	U001	14.00 x	29.00 x	— x	7.00 x	—	50001	U014	14.80 x	30.00 x	— x	8.00 x	—
53170	U019	14.00 x	29.00 x	— x	10.00 x	—	3336	C	14.80 x	32.00 x	— x	5.80 x	—
54259	U002	14.00 x	29.50 x	— x	8.00 x	—	53458	U04A	14.80 x	42.00 x	— x	5.00 x	—
53098	U019	14.00 x	29.50 x	— x	10.15 x	—	52941	U	15.00 x	18.00 x	— x	6.00 x	—
55642	U008	14.00 x	29.70 x	— x	9.10 x	10.30	54287	U005	15.00 x	18.50 x	— x	6.00 x	—
3328	C	14.00 x	30.00 x	— x	6.50 x	—	54288	U006	15.00 x	18.50 x	— x	6.00 x	—
52884	U	14.00 x	30.00 x	— x	8.00 x	—	52941	U031	15.00 x	18.50 x	— x	6.00 x	—
54260	U001	14.00 x	30.00 x	— x	8.00 x	—	53065	U	15.00 x	19.00 x	— x	4.00 x	—
50445	U012	14.00 x	30.00 x	— x	10.00 x	—	53065	U005	15.00 x	19.00 x	— x	5.00 x	—
52897	U002	14.00 x	30.00 x	— x	10.50 x	—	52725	U	15.00 x	19.50 x	— x	4.40 x	—
6434	CH	14.00 x	30.00 x	— x	25.00 x	—	59423	U002	15.00 x	20.00 x	— x	2.30 x	—
55641	U050	14.00 x	30.50 x	— x	8.60 x	10.00	54289	U001	15.00 x	20.00 x	— x	3.00 x	—
54261	U004	14.00 x	30.50 x	— x	9.00 x	—	54290	U002	15.00 x	20.00 x	— x	3.00 x	—
54262	U001	14.00 x	32.00 x	— x	10.00 x	—	54291	U002	15.00 x	20.00 x	— x	5.00 x	—
54263	U002	14.00 x	32.00 x	— x	10.00 x	—	55597	U031	15.00 x	21.00 x	— x	4.90 x	—
54264	U019	14.00 x	32.00 x	— x	10.00 x	—	3056	C	15.00 x	21.00 x	1.00 x	9.00 x	—
54265	U001	14.00 x	34.00 x	— x	10.00 x	—	54292	U002	15.00 x	21.00 x	— x	10.00 x	—
50726	U021	14.00 x	34.00 x	— x	10.00 x	8.50	53521	U005	15.00 x	21.50 x	— x	6.35 x	—
54266	U003	14.00 x	35.00 x	— x	10.00 x	—	59264	U031	15.00 x	21.80 x	— x	—	4.50
54267	U001	14.00 x	35.00 x	— x	12.00 x	—	54293	U001	15.00 x	22.00 x	— x	4.00 x	—
54268	U002	14.00 x	35.00 x	— x	12.00 x	—	50566	U031	15.00 x	22.00 x	— x	4.00 x	—
54269	U001	14.00 x	37.00 x	— x	12.00 x	—	54294	U005	15.00 x	22.00 x	— x	5.00 x	—
54270	U002	14.00 x	37.00 x	— x	12.00 x	—	54295	U005	15.00 x	22.00 x	— x	5.00 x	—
54271	U001	14.00 x	40.00 x	— x	10.00 x	—	54296	U006	15.00 x	22.00 x	— x	5.00 x	—
54272	U002	14.00 x	40.00 x	— x	10.00 x	—	53386	U04A	15.00 x	22.00 x	— x	5.00 x	—
54273	U001	14.00 x	40.00 x	— x	12.00 x	—	52140	U077	15.00 x	22.00 x	— x	5.00 x	—
54274	U002	14.00 x	40.00 x	— x	12.00 x	—	51758	U031	15.00 x	22.50 x	— x	3.18 x	—
54275	U001	14.00 x	50.00 x	— x	15.00 x	—	55560	U005	15.00 x	22.50 x	— x	3.90 x	5.70
54276	U002	14.00 x	50.00 x	— x	15.00 x	—	54297	U004	15.00 x	23.00 x	— x	6.00 x	—
59444	U	14.20 x	21.80 x	— x	6.00 x	—	51904	U005	15.00 x	23.00 x	— x	10.00 x	—
52511	U004	14.20 x	29.70 x	— x	6.50 x	—	54298	U005	15.00 x	23.00 x	— x	10.00 x	—
54277	U001	14.28 x	22.22 x	— x	4.20 x	—	54299	U006	15.00 x	23.00 x	— x	10.00 x	—
53288	U	14.28 x	25.40 x	— x	5.50 x	—	52761	U	15.00 x	23.00 x	— x	16.00 x	—



Cód	Mod	Di x	De x	Esp. x	Ha1 x	Ha2	Cód	Mod	Di x	De x	Esp. x	Ha1 x	Ha2
50770	U011	15.00 x	23.50 x	— x	6.00 x	5.00	50033	U002	15.50 x	24.30 x	— x	6.30 x	—
54300	U001	15.00 x	24.00 x	— x	7.00 x	—	54333	U002	15.50 x	25.50 x	— x	8.00 x	—
54301	U002	15.00 x	24.00 x	— x	7.00 x	—	54334	U019	15.50 x	26.00 x	— x	5.00 x	—
54302	U001	15.00 x	24.00 x	— x	11.00 x	—	6333	CH	15.50 x	26.00 x	— x	31.00 x	—
54303	U002	15.00 x	24.00 x	— x	11.00 x	—	52698	U	15.50 x	27.50 x	— x	10.00 x	—
54304	U031	15.00 x	24.50 x	— x	10.00 x	—	54335	U003	15.50 x	30.50 x	— x	8.00 x	—
54305	U001	15.00 x	25.00 x	— x	5.00 x	—	F4793	W	15.50 x	31.70 x	— x	4.00 x	5.00
51340	U002	15.00 x	25.00 x	— x	5.00 x	—	6150	CH	15.50 x	31.70 x	— x	20.00 x	—
51313	U030	15.00 x	25.00 x	— x	5.00 x	—	50945	U001	15.50 x	38.00 x	— x	6.00 x	—
54306	U006	15.00 x	25.00 x	— x	5.50 x	—	52050	U001	15.80 x	22.00 x	— x	4.50 x	—
51517	U003	15.00 x	25.00 x	— x	6.00 x	—	52300	U031	15.80 x	22.20 x	— x	5.00 x	—
50309	U003	15.00 x	25.00 x	— x	7.00 x	—	52459	UL	15.80 x	23.50 x	— x	4.60 x	5.80
54307	U004	15.00 x	25.00 x	— x	7.00 x	—	53015	U04A	15.80 x	23.80 x	— x	3.80 x	—
54308	U	15.00 x	25.00 x	— x	8.00 x	—	52728	U001	15.80 x	24.50 x	— x	6.00 x	—
52116	U004	15.00 x	25.00 x	— x	8.00 x	—	8315	V	15.80 x	25.40 x	— x	3.90 x	—
54309	U004	15.00 x	25.00 x	— x	8.00 x	—	55603	U	15.80 x	27.00 x	— x	9.00 x	12.00
52116	U004	15.00 x	25.00 x	— x	8.00 x	—	55659	U04A	15.80 x	28.50 x	— x	6.30 x	—
52117	U026	15.00 x	25.00 x	— x	8.00 x	—	52953	U	15.80 x	31.00 x	— x	10.00 x	—
54310	U002	15.00 x	25.00 x	— x	9.00 x	—	3540	C	15.80 x	36.00 x	— x	10.00 x	—
53290	U031	15.00 x	25.00 x	— x	10.00 x	—	59245	UL	15.85 x	24.00 x	— x	5.80 x	8.00
54311	U001	15.00 x	25.00 x	— x	14.00 x	—	51205	U020	15.87 x	20.64 x	— x	6.35 x	—
54312	U002	15.00 x	25.00 x	— x	14.00 x	—	50769	U	15.87 x	22.22 x	— x	3.17 x	—
6272	CH	15.00 x	25.00 x	— x	17.00 x	—	50111	U031	15.87 x	22.22 x	— x	3.57 x	—
50261	U002	15.00 x	27.00 x	— x	4.00 x	—	53410	U04A	15.87 x	22.22 x	— x	3.57 x	—
50011	U020	15.00 x	27.00 x	— x	8.50 x	—	50402	U041	15.87 x	22.22 x	— x	4.76 x	—
51591	U04A	15.00 x	28.00 x	— x	6.00 x	—	51228	U031	15.87 x	22.22 x	— x	6.35 x	—
8071	V	15.00 x	28.00 x	— x	6.00 x	—	50105	U033	15.87 x	22.22 x	— x	6.35 x	—
54313	U001	15.00 x	28.00 x	— x	10.00 x	—	52345	U017	15.87 x	22.22 x	— x	8.00 x	—
54314	U002	15.00 x	28.00 x	— x	10.00 x	—	59382	UL	15.87 x	23.40 x	— x	4.76 x	6.35
54315	U004	15.00 x	28.00 x	— x	10.00 x	—	52812	U001	15.87 x	24.40 x	— x	6.00 x	—
54316	U001	15.00 x	28.00 x	— x	22.00 x	—	54336	U	15.87 x	25.40 x	— x	4.76 x	6.35
54317	U002	15.00 x	28.00 x	— x	22.00 x	—	54337	U001	15.87 x	25.40 x	— x	4.76 x	—
—	CH	15.00 x	28.00 x	— x	29.00 x	—	—	U04A	15.87 x	25.40 x	— x	4.76 x	—
—	CH	15.00 x	29.00 x	— x	27.00 x	—	52021	U019	15.87 x	25.40 x	— x	5.50 x	—
—	CH	15.00 x	29.00 x	— x	30.00 x	—	54338	U001	15.87 x	25.40 x	— x	6.00 x	—
54318	U001	15.00 x	30.00 x	— x	8.00 x	—	50407	U002	15.87 x	25.40 x	— x	6.35 x	—
54319	U002	15.00 x	30.00 x	— x	8.00 x	—	50432	U002	15.87 x	25.40 x	— x	6.35 x	—
54320	U019	15.00 x	30.00 x	— x	8.00 x	—	50586	U008	15.87 x	25.40 x	— x	6.35 x	4.76
54321	U004	15.00 x	30.00 x	— x	10.00 x	—	52133	U004	15.87 x	25.40 x	— x	7.95 x	—
54322	U001	15.00 x	31.00 x	— x	8.00 x	—	F8473	W	15.87 x	25.40 x	— x	9.52 x	—
54323	U002	15.00 x	31.00 x	— x	8.00 x	—	8109	V	15.87 x	28.57 x	— x	5.30 x	—
52853	U001	15.00 x	31.00 x	— x	10.00 x	—	50681	UL	15.87 x	28.57 x	— x	6.35 x	—
54324	U003	15.00 x	31.00 x	— x	10.00 x	—	8020	V	15.87 x	28.57 x	— x	6.35 x	—
3191	C	15.00 x	32.00 x	2.80 x	6.00 x	—	50425	U033	15.87 x	28.57 x	— x	7.14 x	—
54325	U001	15.00 x	34.00 x	— x	8.00 x	—	6260	CH	15.87 x	28.58 x	— x	8.73 x	—
54326	U002	15.00 x	34.00 x	— x	8.00 x	—	8119	V	15.87 x	30.00 x	— x	8.00 x	—
3463	C	15.00 x	35.00 x	3.50 x	10.00 x	—	6062	CH	15.87 x	30.00 x	— x	22.00 x	—
54327	U001	15.00 x	35.00 x	— x	10.00 x	—	50607	U012	15.87 x	30.16 x	— x	10.32 x	—
50276	U002	15.00 x	35.00 x	— x	10.00 x	—	54338	U001	15.87 x	31.75 x	— x	11.11 x	—
54328	U019	15.00 x	35.00 x	— x	10.00 x	—	8186	V	15.87 x	38.10 x	— x	6.35 x	—
54329	U001	15.00 x	35.00 x	— x	15.00 x	—	8056	V	15.87 x	50.01 x	— x	8.73 x	—
54330	U002	15.00 x	35.00 x	— x	15.00 x	—	3060	C	15.87 x	50.80 x	3.17 x	12.70 x	—
54331	U001	15.00 x	40.00 x	— x	10.00 x	—	3255	C	15.87 x	76.20 x	— x	15.87 x	—
54332	U002	15.00 x	40.00 x	— x	10.00 x	—	54339	U002	15.88 x	20.64 x	— x	2.38 x	—
3344	C	15.00 x	40.50 x	— x	14.00 x	—	54340	U002	15.88 x	22.23 x	— x	3.18 x	—
3010	C	15.00 x	42.00 x	4.50 x	12.00 x	—	51574	U	15.88 x	22.23 x	— x	3.57 x	—
—	C	15.00 x	45.00 x	— x	21.00 x	—	54341	U003	15.88 x	22.23 x	— x	3.57 x	—
3482	C	15.00 x	45.00 x	— x	21.00 x	—	54342	U004	15.88 x	22.23 x	— x	3.60 x	—
3228	C	15.00 x	46.00 x	3.00 x	12.00 x	—	54343	U002	15.88 x	22.23 x	— x	6.35 x	—
50973	U002	15.02 x	23.00 x	— x	3.00 x	—	54344	U004	15.88 x	23.02 x	— x	11.11 x	—
50968	U007	15.20 x	24.00 x	— x	6.00 x	5.00	54345	U002	15.88 x	23.81 x	— x	4.76 x	—
3435	C	15.20 x	74.00 x	3.00 x	13.50 x	—	54346	U002	15.88 x	25.40 x	— x	6.00 x	—
F3390	W	15.46 x	31.75 x	— x	5.50 x	4.57	54347	U003	15.88 x	25.40 x	— x	6.35 x	—
3216	C	15.47 x	34.92 x	2.78 x	7.54 x	—	54348	U019	15.88 x	25.40 x	— x	6.35 x	—
53393	U	15.50 x	22.00 x	— x	4.00 x	—	53510	U04A	15.88 x	25.40 x	— x	7.94 x	—
59376	UL	15.50 x	24.30 x	— x	4.00 x	8.00	6263	CH	15.88 x	25.40 x	— x	12.70 x	—
59376	UL	15.50 x	24.30 x	— x	4.00 x	8.00	6363	CH	15.88 x	25.40 x	— x	12.70 x	—



Cód	Mod	Di x	De x	Esp. x	Ha1 x	Ha2	Cód	Mod	Di x	De x	Esp. x	Ha1 x	Ha2
52256	U002	15.88 x	28.58 x	— x	6.35 x	—	50068	U002	16.00 x	25.00 x	— x	5.00 x	4.00
52256	U002	15.88 x	28.58 x	— x	6.35 x	—	54381	U002	16.00 x	25.00 x	— x	5.00 x	—
52256	U002	15.88 x	28.58 x	— x	6.35 x	—	51502	U	16.00 x	25.00 x	— x	5.50 x	—
53407	U04A	15.88 x	28.58 x	— x	6.35 x	—	54382	U031	16.00 x	25.00 x	— x	6.00 x	—
54349	U003	15.88 x	28.58 x	— x	9.53 x	—	54383	U002	16.00 x	25.00 x	— x	6.50 x	—
6073	CH	15.88 x	28.58 x	— x	23.81 x	—	54384	U002	16.00 x	25.00 x	— x	7.00 x	—
54350	U019	15.88 x	31.75 x	— x	6.35 x	—	51645	U005	16.00 x	25.00 x	— x	7.50 x	6.50
—	CH	15.88 x	31.75 x	— x	17.00 x	—	51681	U	16.00 x	25.50 x	— x	5.00 x	—
53369	U	16.00 x	20.00 x	— x	3.00 x	—	54386	U002	16.00 x	25.50 x	— x	5.00 x	—
54351	U002	16.00 x	21.00 x	— x	3.00 x	—	54387	U004	16.00 x	25.50 x	— x	8.00 x	—
52703	U	16.00 x	21.00 x	— x	6.00 x	—	50464	U001	16.00 x	26.00 x	— x	5.00 x	—
54352	U002	16.00 x	21.00 x	— x	6.00 x	—	53496	U04A	16.00 x	26.00 x	— x	5.00 x	—
51133	U008	16.00 x	21.00 x	— x	6.30 x	—	52808	U	16.00 x	26.00 x	— x	6.50 x	6.00
54353	U	16.00 x	21.50 x	— x	4.00 x	5.00	51713	U007	16.00 x	26.00 x	— x	6.80 x	4.80
50538	U004	16.00 x	21.50 x	— x	4.00 x	—	51713	U007	16.00 x	26.00 x	— x	6.80 x	—
54354	U002	16.00 x	21.50 x	— x	4.70 x	—	54388	U005	16.00 x	26.00 x	— x	7.00 x	—
54355	U031	16.00 x	21.50 x	— x	5.00 x	—	54389	U006	16.00 x	26.00 x	— x	7.00 x	—
50013	U077	16.00 x	21.50 x	— x	5.00 x	4.00	53035	U	16.00 x	26.00 x	— x	7.20 x	—
PG1304	U	16.00 x	22.00 x	— x	3.00 x	—	53035	U	16.00 x	26.00 x	— x	7.20 x	—
54356	U001	16.00 x	22.00 x	— x	4.00 x	—	50224	U002	16.00 x	26.00 x	— x	7.50 x	—
54357	U002	16.00 x	22.00 x	— x	4.00 x	—	55574	U04A	16.00 x	26.00 x	— x	7.50 x	—
54358	U005	16.00 x	22.00 x	— x	4.50 x	—	52249	U001	16.00 x	26.00 x	— x	8.00 x	—
54359	U006	16.00 x	22.00 x	— x	5.00 x	—	54390	U004	16.00 x	26.00 x	— x	8.00 x	—
54360	U007	16.00 x	22.00 x	— x	5.00 x	—	53453	U04A	16.00 x	26.00 x	— x	8.00 x	—
50341	U077	16.00 x	22.00 x	— x	5.00 x	—	54391	U008	16.00 x	26.00 x	— x	9.50 x	—
54361	U001	16.00 x	22.00 x	— x	6.00 x	—	53429	U001	16.00 x	26.00 x	— x	10.00 x	—
54362	U002	16.00 x	22.00 x	— x	6.00 x	—	54392	U004	16.00 x	26.00 x	— x	10.00 x	—
54363	U007	16.00 x	22.00 x	— x	6.00 x	—	6095	CH	16.00 x	26.00 x	— x	19.50 x	—
54364	U008	16.00 x	22.00 x	— x	6.00 x	—	51315	U017	16.00 x	26.50 x	— x	7.50 x	—
54365	U002	16.00 x	22.00 x	— x	10.00 x	—	50132	U002	16.00 x	27.00 x	— x	6.50 x	—
54366	U005	16.00 x	22.00 x	— x	10.00 x	—	54393	U004	16.00 x	27.00 x	— x	7.00 x	—
54367	U006	16.00 x	22.00 x	— x	10.00 x	—	3431	C	16.00 x	27.00 x	— x	11.00 x	—
52417	U	16.00 x	22.30 x	— x	6.40 x	—	54394	U002	16.00 x	27.50 x	— x	6.00 x	—
52458	U007	16.00 x	22.50 x	— x	4.10 x	—	59328	U04A	16.00 x	28.00 x	— x	5.00 x	—
59323	UL	16.00 x	23.00 x	— x	4.00 x	6.00	55573	U004	16.00 x	28.00 x	— x	5.50 x	—
52094	U	16.00 x	23.00 x	— x	5.00 x	—	53037	U	16.00 x	28.00 x	— x	5.60 x	—
54368	U001	16.00 x	23.00 x	— x	5.00 x	—	54395	U001	16.00 x	28.00 x	— x	6.00 x	—
54369	U001	16.00 x	23.00 x	— x	6.20 x	—	54396	U002	16.00 x	28.00 x	— x	6.00 x	—
54370	U002	16.00 x	23.00 x	— x	6.20 x	—	—	U04A	16.00 x	28.00 x	— x	6.00 x	—
59236	U005	16.00 x	23.50 x	— x	5.70 x	5.00	59300	U002	16.00 x	28.00 x	— x	6.40 x	—
53507	U006	16.00 x	23.50 x	— x	6.00 x	—	50962	U002	16.00 x	28.00 x	— x	6.50 x	—
52757	U007	16.00 x	23.60 x	— x	6.50 x	5.00	F4350	W	16.00 x	28.00 x	— x	6.50 x	5.50
54371	U	16.00 x	24.00 x	— x	3.50 x	5.50	F4914	W	16.00 x	28.00 x	— x	6.50 x	5.50
54372	U002	16.00 x	24.00 x	— x	4.00 x	—	51525	U011	16.00 x	28.00 x	— x	8.30 x	—
52532	U031	16.00 x	24.00 x	— x	4.00 x	—	6367	CH	16.00 x	28.00 x	— x	36.00 x	—
52531	U001	16.00 x	24.00 x	— x	5.00 x	—	54397	U	16.00 x	29.00 x	— x	6.00 x	—
59414	UL	16.00 x	24.00 x	— x	5.00 x	6.50	54398	U001	16.00 x	29.00 x	— x	6.00 x	—
52969	U	16.00 x	24.00 x	— x	5.50 x	—	51169	U002	16.00 x	29.00 x	— x	6.00 x	—
50071	U002	16.00 x	24.00 x	— x	5.50 x	—	51169	U031	16.00 x	29.00 x	— x	6.00 x	—
52489	U004	16.00 x	24.00 x	— x	5.50 x	—	—	CH	16.00 x	29.00 x	— x	30.00 x	—
52969	U006	16.00 x	24.00 x	— x	5.50 x	—	54399	U001	16.00 x	30.00 x	— x	6.00 x	—
54373	U006	16.00 x	24.00 x	— x	5.50 x	—	54400	U002	16.00 x	30.00 x	— x	6.00 x	—
53361	U006	16.00 x	24.00 x	— x	5.50 x	—	53164	U007	16.00 x	30.00 x	— x	7.00 x	10.00
50056	U016	16.00 x	24.00 x	— x	5.50 x	3.50	53164	U007	16.00 x	30.00 x	— x	7.30 x	—
51825	U	16.00 x	24.00 x	— x	6.50 x	—	8423	V	16.00 x	30.00 x	— x	8.00 x	—
52911	U001	16.00 x	24.00 x	— x	6.80 x	—	3261	C	16.00 x	30.00 x	— x	9.00 x	—
54374	U004	16.00 x	24.00 x	— x	7.00 x	—	3257	C	16.00 x	30.00 x	— x	10.00 x	—
54376	U004	16.00 x	24.00 x	— x	9.00 x	—	6003	CH	16.00 x	30.00 x	— x	16.00 x	—
54375	U005	16.00 x	24.00 x	— x	9.00 x	—	6400	CH	16.00 x	30.00 x	— x	24.00 x	—
54377	U006	16.00 x	24.00 x	— x	9.00 x	—	3432	C	16.00 x	32.00 x	— x	7.00 x	—
54378	U007	16.00 x	24.00 x	— x	9.00 x	—	52447	U001	16.00 x	32.00 x	— x	8.00 x	—
54379	U008	16.00 x	24.00 x	— x	9.00 x	—	54401	U001	16.00 x	32.00 x	— x	8.00 x	—
51047	U003	16.00 x	24.15 x	— x	4.70 x	—	54402	U019	16.00 x	32.00 x	— x	8.00 x	—
52278	U012	16.00 x	24.20 x	— x	6.00 x	4.50	50368	U002	16.00 x	32.00 x	— x	10.00 x	—
8191	V	16.00 x	24.50 x	— x	4.50 x	—	50590	U004	16.00 x	32.00 x	— x	10.00 x	—
54380	U	16.00 x	25.00 x	— x	4.00 x	5.50	52463	U010	16.00 x	32.00 x	— x	10.00 x	—
51225	U005	16.00 x	25.00 x	— x	4.50 x	—	54402	U007	16.00 x	32.00 x	— x	10.50 x	—





Cód	Mod	Di x	De x	Esp. x	Ha1 x	Ha2	Cód	Mod	Di x	De x	Esp. x	Ha1 x	Ha2
54403	U008	16.00 x	32.00 x	— x	10.50 x	—	51867	U	17.00 x	28.00 x	— x	7.00 x	—
54404	U001	16.00 x	32.00 x	— x	11.00 x	—	54438	U002	17.00 x	28.00 x	— x	7.00 x	—
54405	U002	16.00 x	32.00 x	— x	11.00 x	—	54439	U	17.00 x	29.00 x	— x	6.00 x	7.00
54406	U001	16.00 x	32.00 x	— x	12.00 x	—	50477	U037	17.00 x	29.00 x	— x	7.00 x	6.00
50814	U005	16.00 x	32.00 x	— x	12.00 x	10.00	—	CH	17.00 x	30.00 x	— x	29.00 x	—
54407	U005	16.00 x	32.00 x	— x	12.00 x	—	51701	U	17.00 x	35.00 x	— x	10.00 x	—
54408	U001	16.00 x	35.00 x	— x	9.00 x	—	54440	U001	17.00 x	36.00 x	— x	10.00 x	—
54409	U002	16.00 x	35.00 x	— x	9.00 x	—	54441	U002	17.00 x	36.00 x	— x	10.00 x	—
59329	U065	16.00 x	36.00 x	— x	5.00 x	—	54442	U001	17.00 x	38.00 x	— x	10.00 x	—
54410	U001	16.00 x	36.00 x	— x	10.00 x	—	54443	U002	17.00 x	38.00 x	— x	10.00 x	—
54411	U002	16.00 x	36.00 x	— x	10.00 x	—	54444	U019	17.00 x	38.00 x	— x	10.00 x	—
54412	U019	16.00 x	36.00 x	— x	10.00 x	—	54445	U001	17.00 x	40.00 x	— x	12.50 x	—
54413	U001	16.00 x	38.00 x	— x	10.00 x	—	54446	U002	17.00 x	40.00 x	— x	12.50 x	—
54414	U002	16.00 x	38.00 x	— x	10.00 x	—	3327	C	17.00 x	45.00 x	— x	6.00 x	—
54415	U001	16.00 x	40.00 x	— x	12.00 x	—	54447	U001	17.00 x	60.00 x	— x	15.00 x	—
54416	U002	16.00 x	40.00 x	— x	12.00 x	—	54448	U002	17.00 x	60.00 x	— x	15.00 x	—
3212	C	16.00 x	40.00 x	5.00 x	15.00 x	—	54449	U001	17.00 x	63.00 x	— x	15.00 x	—
54417	U031	16.00 x	40.50 x	— x	9.50 x	—	54450	U002	17.00 x	63.00 x	— x	15.00 x	—
3534	C001	16.00 x	45.00 x	— x	10.00 x	—	52763	U001	17.46 x	23.81 x	— x	3.18 x	—
54418	U001	16.00 x	45.00 x	— x	14.50 x	—	50743	U	17.46 x	23.81 x	— x	6.35 x	—
54419	U002	16.00 x	45.00 x	— x	14.50 x	—	51436	U	17.46 x	25.40 x	— x	5.56 x	—
54420	U001	16.00 x	50.00 x	— x	12.00 x	—	54451	U003	17.46 x	25.40 x	— x	5.56 x	—
54421	U002	16.00 x	50.00 x	— x	12.00 x	—	51054	U026	17.46 x	25.40 x	— x	5.56 x	—
3245	C	16.00 x	58.50 x	3.00 x	12.00 x	—	54452	U	17.46 x	26.99 x	— x	4.76 x	6.35
3494	C	16.00 x	76.00 x	— x	18.00 x	—	—	U04A	17.46 x	26.99 x	— x	4.76 x	—
50559	U005	16.20 x	22.20 x	— x	3.90 x	—	50232	U003	17.46 x	26.99 x	— x	6.35 x	4.76
3419	C	16.30 x	53.50 x	— x	11.30 x	—	54453	U019	17.46 x	26.99 x	— x	7.14 x	—
51447	U	16.50 x	20.50 x	— x	3.00 x	—	51669	U04A	17.46 x	26.99 x	— x	7.94 x	—
50991	U003	16.50 x	22.20 x	— x	5.00 x	—	51669	U04A	17.46 x	26.99 x	— x	7.94 x	—
51739	U002	16.50 x	22.50 x	— x	6.00 x	—	54454	U001	17.46 x	28.57 x	— x	5.55 x	—
51195	U	16.50 x	24.00 x	— x	5.00 x	—	50446	U002	17.46 x	28.57 x	— x	5.56 x	—
55633	UL	16.50 x	24.00 x	— x	5.20 x	7.70	54456	U002	17.46 x	28.58 x	— x	5.56 x	—
54422	U001	16.50 x	24.50 x	— x	4.00 x	—	54457	U019	17.46 x	28.58 x	— x	5.56 x	—
52362	U	16.50 x	24.50 x	— x	6.00 x	4.60	50297	U021	17.46 x	30.16 x	— x	7.14 x	—
54423	U007	16.50 x	25.00 x	— x	6.00 x	—	8266	V	17.46 x	31.75 x	— x	6.35 x	—
51319	U002	16.50 x	26.00 x	— x	8.00 x	6.50	50799	U012	17.46 x	44.45 x	— x	10.31 x	7.90
54424	U002	16.50 x	27.00 x	— x	8.00 x	—	51326	U	17.50 x	22.00 x	— x	4.00 x	—
50060	U034	16.50 x	27.00 x	— x	8.80 x	—	54458	U005	17.50 x	23.50 x	— x	4.50 x	—
54425	U002	16.50 x	35.00 x	— x	10.00 x	—	50730	U001	17.50 x	25.00 x	— x	6.00 x	5.50
54426	U002	16.50 x	42.00 x	— x	12.00 x	—	54459	U006	17.50 x	25.40 x	— x	5.50 x	—
3061	C	16.50 x	63.50 x	5.20 x	20.00 x	—	54460	U002	17.50 x	25.50 x	— x	5.00 x	—
53165	U004	16.60 x	25.80 x	— x	8.20 x	—	51926	U031	17.50 x	25.50 x	— x	5.00 x	—
53037	U	16.60 x	28.00 x	— x	5.60 x	—	54461	U001	17.50 x	26.00 x	— x	9.50 x	—
6406	CH	16.80 x	35.00 x	— x	16.00 x	—	53154	U031	17.50 x	26.00 x	— x	9.50 x	—
54427	U031	17.00 x	22.00 x	— x	4.00 x	—	53299	U001	17.50 x	26.50 x	— x	5.00 x	—
54428	U002	17.00 x	23.00 x	— x	4.50 x	—	54463	U005	17.50 x	26.50 x	— x	7.50 x	—
50539	U046	17.00 x	23.50 x	— x	6.00 x	—	53167	U008	17.50 x	27.00 x	— x	6.00 x	—
54429	U002	17.00 x	24.00 x	— x	3.30 x	—	53167	U	17.50 x	27.00 x	— x	7.00 x	—
51092	U004	17.00 x	24.00 x	— x	3.50 x	—	54464	U007	17.60 x	26.80 x	— x	6.00 x	—
54430	U008	17.00 x	24.00 x	— x	5.50 x	—	52488	U	17.80 x	25.60 x	— x	6.00 x	—
54431	U	17.00 x	25.00 x	— x	4.00 x	5.50	52488	U	17.80 x	25.60 x	— x	6.00 x	—
51454	U	17.00 x	25.00 x	— x	5.00 x	—	3445	C	17.80 x	113.40 x	4.00 x	20.00 x	—
51815	U	17.00 x	25.00 x	— x	5.50 x	—	54465	U007	17.86 x	23.81 x	— x	5.16 x	—
54433	U	17.00 x	25.00 x	— x	5.50 x	6.50	50015	U041	18.00 x	23.50 x	— x	3.20 x	—
54432	U007	17.00 x	25.00 x	— x	5.50 x	—	51206	U005	18.00 x	23.50 x	— x	5.00 x	4.00
50546	U008	17.00 x	25.00 x	— x	5.50 x	4.00	54466	U001	18.00 x	24.00 x	— x	4.00 x	—
50564	U042	17.00 x	25.00 x	— x	6.50 x	5.50	50362	U002	18.00 x	24.00 x	— x	4.00 x	—
54434	U004	17.00 x	25.00 x	— x	8.00 x	—	54467	U001	18.00 x	24.00 x	— x	4.50 x	—
54435	U008	17.00 x	25.00 x	— x	8.00 x	—	54468	U002	18.00 x	24.00 x	— x	4.50 x	—
3135	C	17.00 x	25.00 x	4.50 x	9.00 x	—	50913	U	18.00 x	24.00 x	— x	5.00 x	—
54436	U007	17.00 x	25.00 x	— x	10.00 x	—	54469	U001	18.00 x	24.00 x	— x	5.00 x	—
54437	U008	17.00 x	25.00 x	— x	10.00 x	—	53295	U04A	18.00 x	24.00 x	— x	6.00 x	—
55618	U031	17.00 x	25.40 x	— x	4.00 x	—	53210	U	18.00 x	24.20 x	— x	4.00 x	—
59243	U008	17.00 x	26.00 x	— x	6.50 x	—	53210	U	18.00 x	24.20 x	— x	6.35 x	—
8321	V	17.00 x	27.00 x	— x	5.70 x	—	54470	U001	18.00 x	25.00 x	— x	4.00 x	—
51976	U	17.00 x	27.00 x	— x	7.50 x	—	54471	U002	18.00 x	25.00 x	— x	4.00 x	—
59385	UL	17.00 x	28.00 x	— x	5.20 x	7.10	54472	U004	18.00 x	25.00 x	— x	4.00 x	—



Cód	Mod	Di x	De x	Esp. x	Ha1 x	Ha2	Cód	Mod	Di x	De x	Esp. x	Ha1 x	Ha2
54474	U002	18.00 x	25.00 x	— x	5.00 x	—	50030	U007	18.00 x	31.00 x	— x	6.00 x	—
50006	U003	18.00 x	25.00 x	— x	5.00 x	—	8375	V	18.00 x	31.00 x	— x	7.00 x	—
51799	U005	18.00 x	25.00 x	— x	5.00 x	—	54504	U008	18.00 x	31.00 x	— x	8.00 x	—
54473	U005	18.00 x	25.00 x	— x	5.00 x	—	—	CH	18.00 x	31.00 x	— x	29.00 x	—
55712	U04A	18.00 x	25.00 x	— x	5.00 x	—	54505	U001	18.00 x	32.00 x	— x	7.00 x	—
51552	U	18.00 x	25.00 x	— x	5.50 x	—	50642	U002	18.00 x	32.00 x	— x	7.00 x	—
51613	U008	18.00 x	25.00 x	— x	7.80 x	—	50396	U031	18.00 x	32.00 x	— x	10.00 x	—
54475	U002	18.00 x	25.00 x	— x	8.00 x	—	54506	U031	18.00 x	32.00 x	— x	10.00 x	—
54476	U007	18.00 x	25.00 x	— x	8.00 x	—	8217	V	18.00 x	32.00 x	— x	10.00 x	—
54477	U008	18.00 x	25.00 x	— x	8.00 x	—	54507	U001	18.00 x	32.00 x	— x	12.00 x	—
52950	U	18.00 x	25.40 x	— x	5.70 x	—	54508	U002	18.00 x	32.00 x	— x	12.00 x	—
51103	U002	18.00 x	25.50 x	— x	4.00 x	—	—	CH	18.00 x	32.00 x	— x	34.00 x	—
50000	U031	18.00 x	25.50 x	— x	4.00 x	—	54509	U001	18.00 x	34.00 x	— x	8.00 x	—
50000	U031	18.00 x	25.50 x	— x	4.00 x	—	54510	U002	18.00 x	34.00 x	— x	8.00 x	—
59321	U	18.00 x	25.50 x	— x	6.35 x	—	54511	U019	18.00 x	34.00 x	— x	8.00 x	—
55702	U002	18.00 x	25.70 x	— x	4.76 x	6.35	8218	V	18.00 x	34.00 x	— x	8.50 x	—
54478	U001	18.00 x	26.00 x	— x	4.00 x	—	54512	U002	18.00 x	34.50 x	— x	10.50 x	—
54479	U002	18.00 x	26.00 x	— x	4.00 x	—	54513	U001	18.00 x	35.00 x	— x	8.50 x	—
51059	U005	18.00 x	26.00 x	— x	5.00 x	4.50	54514	U002	18.00 x	35.00 x	— x	8.50 x	—
53197	UL	18.00 x	26.00 x	— x	5.00 x	6.50	54515	U005	18.00 x	35.00 x	— x	11.50 x	—
53212	U002	18.00 x	26.00 x	— x	5.50 x	—	50411	U002	18.00 x	35.00 x	— x	12.00 x	—
53209	U04A	18.00 x	26.00 x	— x	5.70 x	—	54516	U004	18.00 x	35.00 x	— x	12.00 x	—
52614	U001	18.00 x	26.00 x	— x	6.00 x	—	53441	U004	18.00 x	35.00 x	— x	12.00 x	—
52614	U001	18.00 x	26.00 x	— x	6.00 x	—	53441	U004	18.00 x	35.00 x	— x	12.00 x	—
54480	U002	18.00 x	26.00 x	— x	6.00 x	—	54517	U001	18.00 x	36.00 x	— x	10.00 x	—
51333	U004	18.00 x	26.00 x	— x	8.00 x	—	54518	U002	18.00 x	36.00 x	— x	10.00 x	—
54481	U004	18.00 x	26.00 x	— x	8.00 x	—	3247	C	18.00 x	38.00 x	3.50 x	10.00 x	—
54482	U006	18.00 x	26.00 x	— x	13.50 x	—	54519	U001	18.00 x	38.00 x	— x	10.00 x	—
54483	U002	18.00 x	26.50 x	— x	8.00 x	—	54520	U002	18.00 x	38.00 x	— x	10.00 x	—
54484	U002	18.00 x	27.00 x	— x	4.50 x	—	54521	U019	18.00 x	38.00 x	— x	10.00 x	—
54485	U001	18.00 x	27.00 x	— x	7.50 x	—	54522	U001	18.00 x	38.00 x	— x	12.00 x	—
54490	U04A	18.00 x	27.00 x	— x	8.00 x	—	54523	U002	18.00 x	38.00 x	— x	12.00 x	—
6230	CH	18.00 x	27.00 x	— x	18.00 x	—	54524	U004	18.00 x	38.00 x	— x	14.00 x	—
54486	U003	18.00 x	27.40 x	— x	5.00 x	—	52088	U002	18.00 x	40.00 x	— x	7.00 x	—
54487	U001	18.00 x	28.00 x	— x	5.00 x	—	55695	U	18.00 x	40.00 x	— x	10.00 x	7.00
54489	U002	18.00 x	28.00 x	— x	5.00 x	—	54525	U001	18.00 x	40.00 x	— x	10.00 x	—
52556	U	18.00 x	28.00 x	— x	6.00 x	—	55694	U002	18.00 x	40.00 x	— x	10.00 x	—
53516	U	18.00 x	28.00 x	— x	8.00 x	—	54526	U019	18.00 x	40.00 x	— x	10.00 x	—
52924	U001	18.00 x	28.00 x	— x	8.00 x	—	3226	C	18.00 x	40.00 x	3.00 x	13.00 x	—
52924	U001	18.00 x	28.00 x	— x	8.00 x	—	54527	U002	18.00 x	41.00 x	— x	5.50 x	—
51973	U002	18.00 x	28.00 x	— x	8.00 x	—	54528	U001	18.00 x	42.00 x	— x	11.50 x	—
53153	U002	18.00 x	28.00 x	— x	8.00 x	—	54529	U002	18.00 x	42.00 x	— x	11.50 x	—
53153	U002	18.00 x	28.00 x	— x	8.00 x	—	54530	U001	18.00 x	45.00 x	— x	10.00 x	—
53153	U002	18.00 x	28.00 x	— x	8.00 x	—	54531	U002	18.00 x	45.00 x	— x	10.00 x	—
54491	U004	18.00 x	28.00 x	— x	8.00 x	—	54532	U004	18.00 x	45.00 x	— x	12.00 x	—
53516	U04A	18.00 x	28.00 x	— x	8.00 x	—	53208	U	18.00 x	46.00 x	— x	12.00 x	—
54492	U004	18.00 x	28.00 x	— x	10.00 x	—	3433	C	18.00 x	50.00 x	— x	12.00 x	—
—	CH	18.00 x	28.00 x	— x	33.00 x	—	3087	C	18.00 x	50.80 x	2.00 x	10.20 x	—
59375	UL	18.00 x	28.50 x	— x	2.50 x	4.50	54533	U001	18.00 x	58.00 x	— x	20.00 x	—
51905	U007	18.00 x	28.58 x	— x	6.35 x	4.70	54534	U002	18.00 x	58.00 x	— x	20.00 x	—
54493	U001	18.00 x	29.00 x	— x	7.00 x	—	54535	U001	18.00 x	62.00 x	— x	8.00 x	—
54494	U002	18.00 x	29.00 x	— x	7.00 x	—	3314	C	18.00 x	101.50 x	6.00 x	25.00 x	—
54495	U005	18.00 x	29.50 x	— x	6.00 x	—	54536	U002	18.26 x	23.02 x	— x	3.57 x	—
59436	U-02	18.00 x	30.00 x	— x	5.00 x	—	54537	U002	18.26 x	23.81 x	— x	6.35 x	—
8015	V	18.00 x	30.00 x	— x	5.00 x	—	51291	U002	18.40 x	34.40 x	— x	10.40 x	—
54496	U001	18.00 x	30.00 x	— x	6.00 x	—	52770	U	18.50 x	26.00 x	— x	7.50 x	—
51785	U002	18.00 x	30.00 x	— x	6.00 x	—	54538	U002	18.50 x	26.50 x	— x	5.00 x	—
54497	U007	18.00 x	30.00 x	— x	6.50 x	—	53183	UL	18.50 x	26.50 x	— x	5.00 x	6.00
54498	U001	18.00 x	30.00 x	— x	8.00 x	—	53183	UL	18.50 x	26.50 x	— x	5.00 x	6.00
54499	U002	18.00 x	30.00 x	— x	8.00 x	—	53183	UL	18.50 x	26.50 x	— x	5.00 x	6.00
54500	U004	18.00 x	30.00 x	— x	8.00 x	—	51646	U031	18.50 x	27.00 x	— x	4.50 x	—
54501	U002	18.00 x	30.00 x	— x	10.00 x	—	54539	U002	18.50 x	28.00 x	— x	6.00 x	—
52953	U004	18.00 x	30.00 x	— x	10.00 x	—	52180	U031	18.50 x	28.00 x	— x	6.00 x	—
6295	CH	18.00 x	30.00 x	— x	23.50 x	—	50325	U004	18.50 x	30.50 x	— x	11.40 x	—
8370	V	18.00 x	30.50 x	— x	6.00 x	—	50143	U031	18.50 x	35.00 x	— x	11.00 x	—
54502	U001	18.00 x	31.00 x	— x	6.00 x	—	54540	U007	18.50 x	36.00 x	— x	9.50 x	—
54503	U002	18.00 x	31.00 x	— x	6.00 x	—	54541	U002	18.50 x	38.00 x	— x	10.00 x	—



Cód	Mod	Di x	De x	Esp. x	Ha1 x	Ha2	Cód	Mod	Di x	De x	Esp. x	Ha1 x	Ha2
51812	U002	18.50 x	44.50 x	— x	12.00 x	—	54562	U002	19.00 x	35.00 x	— x	6.50 x	—
50472	U002	18.60 x	28.30 x	— x	5.00 x	—	54563	U002	19.00 x	35.00 x	— x	9.50 x	—
3401	C	18.60 x	152.00 x	2.50 x	19.00 x	—	54564	U007	19.00 x	35.00 x	— x	12.00 x	—
3444	C	18.70 x	64.50 x	4.00 x	11.00 x	—	54565	U008	19.00 x	35.00 x	— x	12.00 x	—
—	U04A	18.72 x	33.20 x	— x	7.24 x	—	6342	CH	19.00 x	35.50 x	— x	35.00 x	—
54542	U002	18.80 x	25.40 x	— x	3.50 x	—	54566	U004	19.00 x	38.00 x	— x	12.00 x	—
53371	U011	18.80 x	26.00 x	— x	4.70 x	5.30	54567	U001	19.00 x	38.00 x	— x	13.00 x	—
52610	U004	19.00 x	24.00 x	— x	4.50 x	—	54568	U002	19.00 x	38.00 x	— x	13.00 x	—
52131	U	19.00 x	24.00 x	— x	5.00 x	4.00	54569	U001	19.00 x	40.00 x	— x	5.00 x	—
51450	U001	19.00 x	25.00 x	— x	3.00 x	—	54570	U002	19.00 x	40.00 x	— x	5.00 x	—
54543	U	19.00 x	25.00 x	— x	3.50 x	—	54571	U001	19.00 x	40.00 x	— x	10.00 x	—
54544	U003	19.00 x	25.00 x	— x	3.50 x	—	54572	U002	19.00 x	40.00 x	— x	10.00 x	—
50086	U041	19.00 x	25.00 x	— x	5.00 x	—	F7056	J	19.00 x	40.00 x	— x	13.00 x	17.00
54545	U007	19.00 x	25.00 x	— x	5.50 x	—	54573	U001	19.00 x	44.00 x	— x	12.00 x	—
50449	U002	19.00 x	25.00 x	— x	6.00 x	—	54574	U002	19.00 x	44.00 x	— x	12.00 x	—
50079	U065	19.00 x	25.00 x	— x	35.00 x	—	3142	C	19.00 x	51.50 x	— x	14.00 x	—
52964	U	19.00 x	25.40 x	— x	3.40 x	—	3263	C	19.00 x	63.50 x	— x	12.70 x	—
52964	U031	19.00 x	25.40 x	— x	3.40 x	—	3219	C	19.00 x	63.50 x	3.50 x	12.70 x	—
54546	U006	19.00 x	25.40 x	— x	5.50 x	—	3505	C	19.00 x	147.00 x	4.50 x	16.50 x	—
51063	U001	19.00 x	25.40 x	— x	5.80 x	—	50109	U002	19.05 x	24.61 x	— x	3.17 x	—
54547	U002	19.00 x	26.00 x	— x	5.00 x	—	54575	U004	19.05 x	25.00 x	— x	3.00 x	—
51718	U031	19.00 x	26.00 x	— x	5.00 x	—	52959	U002	19.05 x	25.40 x	— x	3.18 x	—
52291	U	19.00 x	26.00 x	— x	6.00 x	—	54576	U004	19.05 x	25.40 x	— x	3.18 x	—
51972	U	19.00 x	27.00 x	— x	4.50 x	—	52395	U	19.05 x	25.40 x	— x	3.20 x	—
52247	U	19.00 x	27.00 x	— x	4.50 x	—	52395	U004	19.05 x	25.40 x	— x	3.20 x	—
8323	V	19.00 x	27.00 x	— x	4.50 x	—	54577	U003	19.05 x	25.40 x	— x	3.97 x	—
52409	U	19.00 x	27.00 x	— x	5.00 x	—	51835	U031	19.05 x	25.40 x	— x	3.97 x	—
52409	U013	19.00 x	27.00 x	— x	5.00 x	—	54578	U002	19.05 x	25.40 x	— x	4.76 x	—
54548	U006	19.00 x	27.00 x	— x	5.50 x	—	50343	U002	19.05 x	25.40 x	— x	5.50 x	—
F9908	J	19.00 x	27.00 x	— x	6.00 x	7.20	54579	U	19.05 x	25.40 x	— x	5.56 x	—
54549	U001	19.00 x	27.00 x	— x	6.00 x	—	50728	U031	19.05 x	25.40 x	— x	6.35 x	—
54550	U002	19.00 x	27.00 x	— x	6.00 x	—	59456	U04A	19.05 x	25.40 x	— x	6.35 x	—
54551	U005	19.00 x	27.00 x	— x	10.00 x	—	59456	U04A	19.05 x	25.40 x	— x	6.35 x	—
54552	U008	19.00 x	27.50 x	— x	5.00 x	—	52909	U	19.05 x	25.80 x	— x	5.56 x	—
51356	U	19.00 x	28.00 x	— x	3.50 x	—	50420	U039	19.05 x	26.19 x	— x	5.56 x	—
54553	U002	19.00 x	28.00 x	— x	5.00 x	—	54580	U006	19.05 x	26.99 x	— x	9.92 x	—
51120	U007	19.00 x	28.00 x	— x	5.00 x	—	8061	V	19.05 x	28.57 x	— x	3.97 x	—
50253	U031	19.00 x	28.00 x	— x	5.30 x	—	51302	U	19.05 x	28.57 x	— x	4.76 x	—
50253	U031	19.00 x	28.00 x	— x	5.30 x	—	51775	U002	19.05 x	28.57 x	— x	4.76 x	—
52118	U002	19.00 x	28.00 x	— x	6.00 x	4.80	50542	U003	19.05 x	28.57 x	— x	6.35 x	—
52867	U	19.00 x	28.00 x	— x	6.35 x	—	8027	V	19.05 x	28.57 x	— x	6.35 x	—
54554	U007	19.00 x	28.00 x	— x	8.00 x	—	54581	U002	19.05 x	28.58 x	— x	4.76 x	—
52259	U002	19.00 x	28.50 x	— x	5.00 x	—	F6132	W	19.05 x	28.60 x	— x	4.00 x	—
51889	U006	19.00 x	29.00 x	— x	6.00 x	4.80	3313	C	19.05 x	29.40 x	— x	8.00 x	—
51924	U007	19.00 x	29.00 x	— x	6.00 x	4.80	54582	U019	19.05 x	30.16 x	— x	6.35 x	—
53051	U002	19.00 x	29.00 x	— x	8.00 x	—	50101	U041	19.05 x	30.16 x	— x	6.35 x	—
54555	U002	19.00 x	29.00 x	— x	8.00 x	—	8398	V	19.05 x	30.16 x	— x	6.35 x	—
3024	C	19.00 x	29.30 x	2.00 x	10.50 x	—	54583	U003	19.05 x	30.16 x	— x	8.73 x	—
51307	U001	19.00 x	30.00 x	— x	5.00 x	—	F2972	W	19.05 x	31.75 x	— x	3.17 x	3.97
F15167	W	19.00 x	30.00 x	— x	5.90 x	6.60	F2972	W	19.05 x	31.75 x	— x	3.17 x	3.97
50027	U001	19.00 x	30.00 x	— x	7.00 x	—	F12692	W	19.05 x	31.75 x	— x	3.50 x	4.50
50046	U002	19.00 x	30.00 x	— x	7.00 x	—	52052	U001	19.05 x	31.75 x	— x	4.76 x	—
50046	U020	19.00 x	30.00 x	— x	7.00 x	—	8384	V	19.05 x	31.75 x	— x	4.76 x	—
50007	U086	19.00 x	30.50 x	— x	9.00 x	—	51802	U	19.05 x	31.75 x	— x	5.55 x	—
54556	U001	19.00 x	31.00 x	— x	4.00 x	—	54584	U019	19.05 x	31.75 x	— x	6.35 x	—
50075	U041	19.00 x	31.00 x	— x	5.00 x	—	54585	U002	19.05 x	31.75 x	— x	6.75 x	—
50346	U002	19.00 x	31.00 x	— x	6.00 x	—	54586	U001	19.05 x	31.75 x	— x	7.00 x	—
51888	U065	19.00 x	31.00 x	— x	6.35 x	—	50116	U002	19.05 x	31.75 x	— x	7.94 x	—
54558	U002	19.00 x	31.00 x	— x	8.00 x	—	54587	U004	19.05 x	31.75 x	— x	9.53 x	—
8254	V	19.00 x	31.50 x	— x	4.00 x	—	6175	CH	19.05 x	31.75 x	— x	19.05 x	—
51494	U	19.00 x	31.75 x	— x	7.00 x	—	6175	CH	19.05 x	31.75 x	— x	24.00 x	—
50667	U005	19.00 x	32.00 x	— x	6.50 x	—	54588	U019	19.05 x	33.34 x	— x	7.94 x	—
—	CH	19.00 x	32.00 x	— x	29.00 x	—	54589	U019	19.05 x	34.93 x	— x	7.94 x	—
—	CH	19.00 x	32.00 x	— x	30.00 x	—	6171	CH	19.05 x	34.93 x	— x	14.29 x	—
54559	U004	19.00 x	33.00 x	— x	8.00 x	—	6171	CH	19.05 x	34.93 x	— x	14.29 x	—
54560	U001	19.00 x	34.00 x	— x	8.00 x	—	8050	V	19.05 x	38.10 x	— x	6.35 x	—
54561	U002	19.00 x	34.00 x	— x	8.00 x	—	8040	V	19.05 x	38.10 x	— x	8.73 x	—



Cód	Mod	Di x	De x	Esp. x	Ha1 x	Ha2	Cód	Mod	Di x	De x	Esp. x	Ha1 x	Ha2
3146	C	19.05 x	38.10 x	— x	9.52 x	—	54607	U004	20.00 x	27.50 x	— x	5.00 x	—
—	U04A	19.05 x	38.10 x	— x	9.52 x	—	50990	U008	20.00 x	27.50 x	— x	5.00 x	3.50
3028	C	19.05 x	38.10 x	3.17 x	11.11 x	—	52833	U031	20.00 x	27.50 x	— x	6.40 x	—
8121	V	19.05 x	47.62 x	— x	11.11 x	—	54608	U	20.00 x	28.00 x	— x	3.50 x	5.50
6017	CH	19.05 x	47.63 x	— x	31.75 x	—	51144	U	20.00 x	28.00 x	— x	4.00 x	—
3159	C	19.05 x	50.80 x	4.00 x	14.29 x	—	51459	U	20.00 x	28.00 x	— x	4.00 x	—
3033	C	19.05 x	50.80 x	4.00 x	15.87 x	—	54609	U001	20.00 x	28.00 x	— x	4.00 x	—
3211	C001	19.05 x	63.50 x	3.00 x	12.70 x	—	50683	U005	20.00 x	28.00 x	— x	4.00 x	—
6177	CH	19.05 x	69.95 x	— x	62.00 x	—	50683	U005	20.00 x	28.00 x	— x	4.00 x	—
54590	U031	19.05 x	73.03 x	— x	26.99 x	—	53319	U04A	20.00 x	28.00 x	— x	4.00 x	—
3333	C	19.05 x	101.60 x	— x	12.70 x	—	52722	U	20.00 x	28.00 x	— x	4.50 x	—
3449	C	19.05 x	101.60 x	— x	19.05 x	—	53475	U	20.00 x	28.00 x	— x	4.50 x	6.00
53529	U044	19.10 x	29.80 x	— x	10.00 x	—	51724	U	20.00 x	28.00 x	— x	5.00 x	—
51141	U002	19.20 x	30.60 x	— x	9.00 x	—	52223	U	20.00 x	28.00 x	— x	5.00 x	—
3220	C	19.20 x	40.00 x	3.50 x	10.00 x	—	54610	U002	20.00 x	28.00 x	— x	5.00 x	—
50291	U006	19.30 x	25.00 x	— x	5.00 x	—	54611	U006	20.00 x	28.00 x	— x	5.00 x	—
54591	U008	19.30 x	32.00 x	— x	7.90 x	—	51689	U047	20.00 x	28.00 x	— x	5.00 x	—
50757	U031	19.40 x	27.80 x	— x	6.20 x	—	52499	U	20.00 x	28.00 x	— x	5.50 x	—
51990	U	19.50 x	25.50 x	— x	4.20 x	—	50051	U005	20.00 x	28.00 x	— x	5.50 x	3.50
50876	U004	19.50 x	26.50 x	— x	4.50 x	—	50051	U005	20.00 x	28.00 x	— x	5.50 x	—
54592	U031	19.50 x	26.50 x	— x	5.00 x	—	52499	U006	20.00 x	28.00 x	— x	5.50 x	—
54593	U004	19.50 x	27.00 x	— x	4.50 x	—	52528	U006	20.00 x	28.00 x	— x	5.50 x	—
54594	U007	19.50 x	27.50 x	— x	8.00 x	—	50527	U052	20.00 x	28.00 x	— x	5.70 x	—
54595	U008	19.50 x	27.50 x	— x	8.00 x	—	51661	U	20.00 x	28.00 x	— x	6.00 x	—
52182	U	19.50 x	28.00 x	— x	4.70 x	—	54611	U04A	20.00 x	28.00 x	— x	6.00 x	—
54596	U003	19.50 x	28.50 x	— x	4.90 x	—	54612	U004	20.00 x	28.00 x	— x	7.00 x	—
51894	U	19.50 x	28.58 x	— x	4.76 x	—	51936	U031	20.00 x	28.00 x	— x	7.50 x	—
51516	U031	19.50 x	30.00 x	— x	6.00 x	—	51936	U031	20.00 x	28.00 x	— x	7.50 x	—
50090	U001	19.50 x	30.00 x	— x	7.00 x	—	54613	U001	20.00 x	28.00 x	— x	8.00 x	—
50090	U001	19.50 x	30.00 x	— x	7.00 x	—	53173	U001	20.00 x	28.00 x	— x	8.00 x	—
6267	CH	19.50 x	30.00 x	— x	22.00 x	—	53173	U001	20.00 x	28.00 x	— x	8.00 x	—
F3623	W	19.50 x	31.00 x	— x	5.80 x	6.50	54614	U005	20.00 x	28.00 x	— x	8.00 x	—
F2623	W	19.50 x	31.00 x	— x	6.50 x	5.80	54615	U006	20.00 x	28.00 x	— x	8.00 x	—
52102	U002	19.50 x	31.30 x	— x	6.30 x	—	54616	U007	20.00 x	28.00 x	— x	8.00 x	—
50486	U003	19.50 x	32.00 x	— x	8.00 x	—	54617	U008	20.00 x	28.00 x	— x	8.00 x	—
53364	U002	19.50 x	34.00 x	— x	7.00 x	—	54618	U031	20.00 x	28.00 x	— x	8.00 x	—
3150	C	19.50 x	57.30 x	3.00 x	12.50 x	—	54619	U001	20.00 x	28.00 x	— x	15.00 x	—
3011	C	19.50 x	76.00 x	3.00 x	15.00 x	—	54620	U007	20.00 x	28.50 x	— x	5.00 x	—
3416	C	19.50 x	101.60 x	— x	19.50 x	—	50820	U034	20.00 x	28.50 x	— x	5.50 x	3.90
8405	V	19.60 x	28.00 x	— x	3.50 x	—	55629	U004	20.00 x	28.50 x	— x	7.30 x	—
50720	U004	19.60 x	30.40 x	— x	6.00 x	—	50705	U	20.00 x	28.50 x	— x	8.00 x	5.00
8151	V	19.60 x	30.40 x	— x	6.00 x	—	50928	U002	20.00 x	29.00 x	— x	5.00 x	—
8151	V	19.60 x	30.40 x	— x	6.00 x	—	54621	U002	20.00 x	29.00 x	— x	5.00 x	—
54597	U005	20.00 x	25.00 x	— x	5.00 x	—	59343	U04A	20.00 x	29.50 x	— x	7.50 x	—
51111	U053	20.00 x	25.00 x	— x	5.00 x	4.00	54622	U002	20.00 x	30.00 x	— x	4.00 x	—
51480	U	20.00 x	25.40 x	— x	1.50 x	—	50665	U031	20.00 x	30.00 x	— x	4.00 x	—
54598	U005	20.00 x	25.50 x	— x	4.00 x	—	52377	U001	20.00 x	30.00 x	— x	5.00 x	—
52562	U031	20.00 x	25.50 x	— x	4.00 x	—	52954	U	20.00 x	30.00 x	— x	6.00 x	—
54599	U001	20.00 x	26.00 x	— x	4.00 x	—	52954	U002	20.00 x	30.00 x	— x	6.00 x	—
54600	U002	20.00 x	26.00 x	— x	4.00 x	—	54623	U005	20.00 x	30.00 x	— x	6.00 x	—
59299	U004	20.00 x	26.00 x	— x	5.00 x	—	50779	U002	20.00 x	30.00 x	— x	7.00 x	6.00
54601	U005	20.00 x	26.00 x	— x	5.00 x	—	50779	U002	20.00 x	30.00 x	— x	7.00 x	—
52970	U006	20.00 x	26.00 x	— x	5.00 x	—	52668	U04A	20.00 x	30.00 x	— x	7.00 x	—
52962	U008	20.00 x	26.00 x	— x	5.00 x	—	54625	U001	20.00 x	30.00 x	— x	8.00 x	—
54602	U008	20.00 x	26.00 x	— x	5.00 x	—	54624	U002	20.00 x	30.00 x	— x	8.00 x	—
52970	U105	20.00 x	26.00 x	— x	5.00 x	—	52711	U002	20.00 x	30.00 x	— x	8.00 x	—
—	U04A	20.00 x	26.00 x	— x	6.50 x	—	51720	U004	20.00 x	30.00 x	— x	8.00 x	5.00
51915	U	20.00 x	26.00 x	— x	27.00 x	—	51190	U004	20.00 x	30.00 x	— x	8.00 x	7.00
53259	UL	20.00 x	26.50 x	— x	4.40 x	—	52708	U031	20.00 x	30.00 x	— x	8.00 x	—
53259	UL	20.00 x	26.50 x	— x	6.35 x	—	50849	U031	20.00 x	30.00 x	— x	8.00 x	—
59380	UL	20.00 x	26.70 x	— x	4.40 x	6.35	50366	U040	20.00 x	30.00 x	— x	10.00 x	—
54603	U002	20.00 x	27.00 x	— x	3.00 x	—	50366	U040	20.00 x	30.00 x	— x	10.00 x	—
54604	U002	20.00 x	27.00 x	— x	6.00 x	—	50366	U040	20.00 x	30.00 x	— x	10.00 x	—
54605	U005	20.00 x	27.00 x	— x	6.00 x	—	F13194	ESPE	20.00 x	30.00 x	— x	10.40 x	—
54606	U006	20.00 x	27.00 x	— x	6.00 x	—	54626	U004	20.00 x	30.00 x	— x	10.50 x	—
52558	U008	20.00 x	27.00 x	— x	6.00 x	—	51550	U030	20.00 x	30.00 x	— x	11.00 x	—
52159	U004	20.00 x	27.50 x	— x	5.00 x	—	51088	U	20.00 x	30.00 x	— x	12.00 x	—





Cód	Mod	Di x	De x	Esp. x	Ha1 x	Ha2	Cód	Mod	Di x	De x	Esp. x	Ha1 x	Ha2
53541	U006	20.00 x	30.00 x	— x	12.00 x	—	54654	U002	20.00 x	35.50 x	— x	8.00 x	—
50041	U044	20.00 x	30.00 x	— x	16.00 x	—	54655	U001	20.00 x	36.00 x	— x	6.00 x	—
6190	CH	20.00 x	30.00 x	— x	18.50 x	—	54656	U002	20.00 x	36.00 x	— x	6.00 x	—
52807	U006	20.00 x	30.50 x	— x	6.50 x	7.50	52403	U	20.00 x	36.00 x	— x	8.00 x	—
50901	U	20.00 x	30.90 x	— x	4.50 x	—	54657	U019	20.00 x	36.00 x	— x	8.00 x	—
8196	V	20.00 x	31.00 x	— x	5.00 x	—	54658	U001	20.00 x	36.00 x	— x	8.50 x	—
51269	U002	20.00 x	31.00 x	— x	7.00 x	—	54659	U002	20.00 x	36.00 x	— x	10.00 x	—
54627	U006	20.00 x	31.00 x	— x	8.00 x	—	52160	U	20.00 x	36.50 x	— x	8.00 x	—
53001	UL	20.00 x	31.00 x	— x	8.70 x	—	54660	U001	20.00 x	36.70 x	— x	8.00 x	—
53003	U	20.00 x	31.00 x	— x	10.00 x	—	54661	U002	20.00 x	36.70 x	— x	8.00 x	—
53003	U007	20.00 x	31.00 x	— x	10.00 x	—	54662	U001	20.00 x	37.00 x	— x	8.00 x	—
54627	U007	20.00 x	31.00 x	— x	10.00 x	—	54663	U002	20.00 x	37.00 x	— x	8.00 x	—
53001	UL	20.00 x	31.00 x	— x	10.20 x	8.70	51046	U	20.00 x	38.00 x	— x	8.00 x	—
53001	UL	20.00 x	31.00 x	— x	10.20 x	—	3392	C	20.00 x	38.00 x	— x	8.50 x	—
51147	U	20.00 x	31.50 x	— x	6.50 x	—	54664	U001	20.00 x	38.00 x	— x	8.50 x	—
54628	U031	20.00 x	31.50 x	— x	6.50 x	—	54665	U002	20.00 x	38.00 x	— x	8.50 x	—
54629	U002	20.00 x	31.50 x	— x	8.00 x	—	3350	C	20.00 x	38.00 x	— x	10.00 x	—
51693	U	20.00 x	32.00 x	— x	6.00 x	—	54666	U001	20.00 x	38.00 x	— x	10.00 x	—
52837	U	20.00 x	32.00 x	— x	6.00 x	—	54667	U002	20.00 x	38.00 x	— x	10.00 x	—
54630	U002	20.00 x	32.00 x	— x	6.00 x	—	54668	U002	20.00 x	38.50 x	— x	6.00 x	—
54631	U005	20.00 x	32.00 x	— x	6.00 x	—	—	CH	20.00 x	38.50 x	— x	43.50 x	—
54632	U006	20.00 x	32.00 x	— x	6.00 x	—	54669	U001	20.00 x	39.00 x	— x	10.00 x	—
50070	U009	20.00 x	32.00 x	— x	6.40 x	—	54670	U002	20.00 x	39.00 x	— x	10.00 x	—
F3803	J	20.00 x	32.00 x	— x	6.50 x	9.50	50131	U047	20.00 x	39.50 x	— x	10.00 x	—
54633	U001	20.00 x	32.00 x	— x	6.50 x	—	F5784	J	20.00 x	39.50 x	— x	13.00 x	15.50
50648	U026	20.00 x	32.00 x	— x	6.50 x	—	54671	U001	20.00 x	40.00 x	— x	8.00 x	—
50303	U019	20.00 x	32.00 x	— x	6.80 x	—	54672	U002	20.00 x	40.00 x	— x	8.00 x	—
51396	U	20.00 x	32.00 x	— x	7.50 x	—	53224	U001	20.00 x	40.00 x	— x	10.00 x	—
50797	U001	20.00 x	32.00 x	— x	8.00 x	—	50767	U003	20.00 x	40.00 x	— x	10.00 x	—
54634	U004	20.00 x	32.00 x	— x	8.00 x	—	51630	U003	20.00 x	40.00 x	— x	10.00 x	—
50797	U031	20.00 x	32.00 x	— x	8.00 x	—	54673	U019	20.00 x	40.00 x	— x	10.00 x	—
50745	U	20.00 x	32.00 x	— x	9.00 x	—	54674	U031	20.00 x	40.00 x	— x	10.00 x	—
50360	U046	20.00 x	32.00 x	— x	10.00 x	—	53224	U04A	20.00 x	40.00 x	— x	10.00 x	—
F2649	J	20.00 x	32.00 x	— x	12.00 x	8.00	54675	U004	20.00 x	40.00 x	— x	12.00 x	—
6093	CH	20.00 x	32.00 x	— x	50.00 x	—	54676	U001	20.00 x	40.00 x	— x	16.00 x	—
54635	U001	20.00 x	32.50 x	— x	6.00 x	—	54677	U002	20.00 x	40.00 x	— x	16.00 x	—
54636	U002	20.00 x	32.50 x	— x	6.00 x	—	6207	CH	20.00 x	40.00 x	— x	30.00 x	—
54638	U031	20.00 x	32.50 x	— x	9.00 x	—	54678	U004	20.00 x	40.50 x	— x	11.00 x	—
53127	U004	20.00 x	32.50 x	— x	9.60 x	—	54679	U001	20.00 x	42.00 x	— x	7.50 x	—
54639	U001	20.00 x	33.00 x	— x	6.00 x	—	54680	U002	20.00 x	42.00 x	— x	7.50 x	—
54640	U002	20.00 x	33.00 x	— x	6.00 x	—	54681	U001	20.00 x	42.00 x	— x	12.00 x	—
54641	U007	20.00 x	33.00 x	— x	7.00 x	—	54682	U002	20.00 x	42.00 x	— x	12.00 x	—
54642	U008	20.00 x	33.00 x	— x	7.00 x	—	54683	U001	20.00 x	43.00 x	— x	10.00 x	—
54643	U002	20.00 x	33.00 x	— x	8.00 x	—	54684	U002	20.00 x	43.00 x	— x	10.00 x	—
6250	CH	20.00 x	33.00 x	— x	21.00 x	—	54685	U001	20.00 x	43.00 x	— x	12.00 x	—
6368	CH	20.00 x	33.00 x	— x	37.00 x	—	54686	U002	20.00 x	43.00 x	— x	12.00 x	—
54644	U	20.00 x	34.00 x	— x	7.00 x	—	54687	U019	20.00 x	43.00 x	— x	12.00 x	—
54646	U001	20.00 x	34.00 x	— x	8.00 x	—	50350	U087	20.00 x	44.00 x	— x	7.50 x	—
54645	U002	20.00 x	34.00 x	— x	8.00 x	—	54688	U001	20.00 x	45.00 x	— x	12.00 x	—
50473	U037	20.00 x	34.00 x	— x	8.00 x	7.00	54689	U002	20.00 x	45.00 x	— x	12.00 x	—
50481	U031	20.00 x	34.00 x	— x	9.00 x	—	50366	U040	20.00 x	50.00 x	— x	10.00 x	—
50440	U001	20.00 x	34.00 x	— x	10.00 x	—	54690	U002	20.00 x	50.00 x	— x	12.00 x	—
54647	U004	20.00 x	34.50 x	— x	10.00 x	—	3207	C	20.00 x	50.00 x	2.50 x	13.00 x	—
52685	U047	20.00 x	34.50 x	— x	11.00 x	9.00	54691	U001	20.00 x	50.00 x	— x	15.00 x	—
F15309	J	20.00 x	35.00 x	12.70 x	—	—	6366	CH	20.00 x	50.00 x	— x	32.00 x	—
52648	U004	20.00 x	35.00 x	— x	5.00 x	—	50202	U004	20.00 x	52.00 x	— x	16.00 x	—
52176	U	20.00 x	35.00 x	— x	8.00 x	—	3500	C001	20.00 x	53.00 x	5.00 x	12.00 x	—
52176	U	20.00 x	35.00 x	— x	8.00 x	—	3151	C	20.00 x	60.00 x	3.00 x	14.00 x	—
54649	U001	20.00 x	35.00 x	— x	8.00 x	—	3361	C	20.00 x	60.00 x	— x	90.00 x	—
54648	U002	20.00 x	35.00 x	— x	8.00 x	—	3513	C	20.00 x	61.50 x	— x	14.00 x	—
54650	U002	20.00 x	35.00 x	— x	9.50 x	—	3513	C	20.00 x	61.50 x	— x	14.00 x	—
54651	U001	20.00 x	35.00 x	— x	10.00 x	—	53079	U003	20.00 x	64.00 x	— x	4.00 x	—
54652	U004	20.00 x	35.00 x	— x	10.00 x	—	3307	C	20.00 x	64.00 x	— x	13.00 x	—
50328	U005	20.00 x	35.00 x	— x	10.00 x	—	3059	C	20.00 x	72.00 x	6.00 x	10.00 x	—
52684	U047	20.00 x	35.00 x	— x	11.00 x	—	3059	C001	20.00 x	72.00 x	— x	10.00 x	—
F15309	J	20.00 x	35.00 x	— x	12.70 x	—	53113	U	20.10 x	29.80 x	— x	10.00 x	—
54653	U001	20.00 x	35.50 x	— x	8.00 x	—	53113	U044	20.10 x	29.80 x	— x	10.00 x	—



Cód	Mod	Di x	De x	Esp. x	Ha1 x	Ha2	Cód	Mod	Di x	De x	Esp. x	Ha1 x	Ha2
F15931	U	20.20 x	26.00 x	— x	4.40 x	—	53169	U004	21.50 x	27.00 x	— x	9.00 x	—
51974	U042	20.24 x	25.40 x	— x	3.96 x	—	53041	U	21.50 x	31.50 x	— x	6.35 x	5.00
52672	U	20.30 x	27.00 x	— x	4.00 x	—	53041	U041	21.50 x	31.50 x	— x	6.35 x	5.00
6117	CH	20.32 x	228.60 x	— x	38.10 x	—	3131	C	21.50 x	31.50 x	— x	8.00 x	—
54692	U007	20.50 x	28.00 x	— x	6.00 x	—	8249	V	21.50 x	36.50 x	— x	7.00 x	—
54693	U008	20.50 x	28.58 x	— x	5.00 x	—	59265	U	21.55 x	26.50 x	— x	6.60 x	—
3217	C	20.50 x	30.00 x	3.50 x	8.00 x	—	59272	U04A	21.60 x	30.40 x	— x	7.70 x	—
54694	U007	20.50 x	30.00 x	— x	11.00 x	—	53497	U061	21.60 x	60.80 x	— x	10.00 x	—
50777	U009	20.50 x	30.50 x	— x	6.70 x	—	52765	U	21.80 x	34.00 x	— x	7.00 x	9.50
F4273	J	20.50 x	30.50 x	— x	7.00 x	9.70	3440	C	21.80 x	99.40 x	— x	5.00 x	—
54695	U005	20.50 x	30.50 x	— x	7.50 x	—	3440	C	21.80 x	99.40 x	5.00 x	25.00 x	—
50646	U056	20.50 x	34.00 x	— x	7.50 x	—	3440	C	21.80 x	99.40 x	— x	25.00 x	—
50061	U056	20.50 x	36.50 x	— x	8.30 x	—	59325	U002	22.00 x	27.50 x	— x	3.20 x	—
54698	U002	20.50 x	41.50 x	— x	8.00 x	—	53292	UL	22.00 x	28.00 x	— x	4.00 x	4.70
3279	C	20.50 x	75.00 x	4.00 x	20.00 x	—	51627	U001	22.00 x	28.00 x	— x	4.50 x	—
52198	U	20.60 x	22.00 x	— x	12.50 x	—	54716	U002	22.00 x	28.00 x	— x	5.00 x	—
53180	U004	20.60 x	26.90 x	— x	3.17 x	—	51737	U031	22.00 x	28.00 x	— x	5.00 x	—
53180	U004	20.60 x	26.90 x	— x	3.17 x	—	54717	U008	22.00 x	28.00 x	— x	6.00 x	—
51635	U006	20.60 x	28.20 x	— x	7.00 x	3.80	54718	U001	22.00 x	28.00 x	— x	8.00 x	—
51935	U	20.60 x	30.10 x	— x	6.35 x	4.76	54719	U002	22.00 x	28.00 x	— x	8.00 x	—
50231	U048	20.60 x	31.50 x	— x	7.00 x	—	52334	U	22.00 x	28.50 x	— x	3.50 x	—
3377	C	20.60 x	76.20 x	— x	11.11 x	—	53363	U004	22.00 x	28.50 x	— x	8.00 x	—
51168	U	20.63 x	28.58 x	— x	4.76 x	—	59314	U002	22.00 x	29.00 x	— x	5.00 x	—
8267	V	20.63 x	31.75 x	— x	5.56 x	—	50679	U004	22.00 x	29.00 x	— x	6.80 x	—
54699	U004	20.64 x	26.99 x	— x	3.18 x	—	50679	U04A	22.00 x	29.00 x	— x	6.80 x	—
—	U04A	20.64 x	30.16 x	— x	7.94 x	—	53198	U021	22.00 x	29.00 x	— x	7.00 x	9.00
8183	V	20.64 x	33.34 x	— x	3.17 x	—	54680	U005	22.00 x	29.00 x	— x	7.60 x	—
—	U04A	20.64 x	33.34 x	— x	6.35 x	—	54720	U006	22.00 x	29.00 x	— x	7.60 x	—
54700	U004	20.64 x	34.93 x	— x	10.32 x	—	54721	U001	22.00 x	29.00 x	— x	8.00 x	—
54701	U019	20.64 x	36.51 x	— x	9.53 x	—	52462	U031	22.00 x	29.50 x	— x	5.00 x	—
3009	C	20.64 x	63.50 x	3.17 x	9.52 x	—	59306	U002	22.00 x	30.00 x	— x	3.20 x	—
51920	U031	20.70 x	66.00 x	— x	27.00 x	—	52072	U	22.00 x	30.00 x	— x	4.00 x	—
52137	U003	20.80 x	25.20 x	— x	4.00 x	—	55622	U002	22.00 x	30.00 x	— x	4.80 x	—
52789	U074	20.90 x	34.50 x	— x	6.35 x	—	50839	U002	22.00 x	30.00 x	— x	5.00 x	—
8395	V	20.90 x	34.50 x	— x	6.35 x	—	52979	U	22.00 x	30.00 x	— x	5.50 x	—
50031	U006	21.00 x	28.00 x	— x	5.00 x	—	50857	U002	22.00 x	30.00 x	— x	5.50 x	—
50331	U008	21.00 x	28.00 x	— x	6.00 x	7.00	52979	U005	22.00 x	30.00 x	— x	5.50 x	—
54702	U	21.00 x	28.00 x	— x	6.70 x	—	52889	U005	22.00 x	30.00 x	— x	5.50 x	—
51042	U031	21.00 x	29.00 x	— x	5.00 x	—	54722	U005	22.00 x	30.00 x	— x	5.50 x	—
50242	U006	21.00 x	29.00 x	— x	6.00 x	—	54723	U006	22.00 x	30.00 x	— x	5.50 x	—
51172	U007	21.00 x	29.00 x	— x	6.00 x	5.00	51017	U031	22.00 x	30.00 x	— x	5.50 x	—
54703	U007	21.00 x	29.00 x	— x	6.00 x	—	51543	U	22.00 x	30.00 x	— x	6.00 x	—
54704	U007	21.00 x	29.00 x	— x	8.00 x	—	52903	U001	22.00 x	30.00 x	— x	6.00 x	—
54705	U008	21.00 x	29.00 x	— x	8.00 x	—	54724	U002	22.00 x	30.00 x	— x	6.00 x	—
50285	U044	21.00 x	29.20 x	— x	16.00 x	—	50754	U017	22.00 x	30.00 x	— x	6.00 x	—
55551	U	21.00 x	31.00 x	— x	7.30 x	—	51543	UL	22.00 x	30.00 x	— x	6.00 x	4.50
54706	U001	21.00 x	31.50 x	— x	9.00 x	—	54726	U002	22.00 x	30.00 x	— x	6.50 x	—
53508	U007	21.00 x	34.00 x	— x	7.50 x	—	53195	U002	22.00 x	30.00 x	— x	7.00 x	—
50298	U056	21.00 x	34.00 x	— x	7.50 x	—	54727	U005	22.00 x	30.00 x	— x	7.00 x	—
—	CH	21.00 x	34.00 x	— x	29.00 x	—	54728	U007	22.00 x	30.00 x	— x	8.00 x	—
52811	U041	21.00 x	35.00 x	— x	11.20 x	—	8257	V	22.00 x	30.00 x	— x	8.00 x	—
—	CH	21.00 x	35.00 x	— x	39.00 x	—	55746	U046	22.00 x	30.00 x	— x	8.50 x	—
54707	U001	21.00 x	37.00 x	— x	8.50 x	—	54729	U007	22.00 x	30.00 x	— x	10.00 x	—
54708	U002	21.00 x	37.00 x	— x	8.50 x	—	54730	U008	22.00 x	30.00 x	— x	10.00 x	—
54709	U007	21.00 x	37.00 x	— x	12.00 x	—	54731	U005	22.00 x	30.00 x	— x	13.50 x	—
54710	U008	21.00 x	37.00 x	— x	12.00 x	—	54732	U006	22.00 x	30.00 x	— x	13.50 x	—
6451	CH	21.00 x	39.00 x	— x	22.00 x	—	59374	UL	22.00 x	30.50 x	— x	4.00 x	5.60
3236	C	21.00 x	40.00 x	— x	9.00 x	—	54733	U001	22.00 x	30.50 x	— x	7.00 x	—
54711	U001	21.00 x	40.00 x	— x	10.00 x	—	54734	U002	22.00 x	30.50 x	— x	7.00 x	—
54712	U001	21.00 x	40.00 x	— x	10.00 x	—	51917	U002	22.00 x	30.50 x	— x	8.50 x	—
54713	U002	21.00 x	40.00 x	— x	10.00 x	—	54735	U001	22.00 x	31.00 x	— x	4.00 x	—
3481	C	21.00 x	45.00 x	— x	15.00 x	—	54736	U001	22.00 x	31.00 x	— x	4.50 x	—
3234	C	21.00 x	69.00 x	7.00 x	20.00 x	—	54737	U006	22.00 x	31.00 x	— x	5.00 x	—
3138	C	21.00 x	70.00 x	3.00 x	20.00 x	—	51907	U012	22.00 x	31.00 x	— x	5.00 x	—
3169	C	21.00 x	85.00 x	3.50 x	20.00 x	—	51058	U053	22.00 x	31.00 x	— x	5.00 x	4.00
3130	C	21.00 x	97.00 x	3.50 x	20.00 x	—	59458	UL	22.00 x	31.00 x	— x	5.50 x	11.50
54714	U019	21.30 x	34.90 x	— x	6.30 x	—	51057	U005	22.00 x	31.00 x	— x	7.00 x	6.00



Cód	Mod	Di x	De x	Esp. x	Ha1 x	Ha2	Cód	Mod	Di x	De x	Esp. x	Ha1 x	Ha2
55592	U056	22.00 x	31.80 x	— x	5.00 x	—	54773	U002	22.00 x	40.00 x	— x	8.00 x	—
55606	U	22.00 x	32.00 x	— x	3.00 x	5.00	54774	U001	22.00 x	40.00 x	— x	10.00 x	—
50463	U050	22.00 x	32.00 x	— x	4.70 x	—	52540	U002	22.00 x	40.00 x	— x	10.00 x	—
54738	U001	22.00 x	32.00 x	— x	5.00 x	—	50785	U002	22.00 x	40.00 x	— x	12.00 x	—
54739	U002	22.00 x	32.00 x	— x	5.00 x	—	54775	U001	22.00 x	40.00 x	— x	12.50 x	—
51134	U003	22.00 x	32.00 x	— x	5.00 x	—	54776	U002	22.00 x	40.00 x	— x	12.50 x	—
51134	U003	22.00 x	32.00 x	— x	5.00 x	—	50078	U002	22.00 x	41.00 x	— x	6.00 x	—
52889	U	22.00 x	32.00 x	— x	5.50 x	—	8068	V	22.00 x	41.00 x	— x	8.50 x	—
52889	U	22.00 x	32.00 x	— x	5.50 x	—	54779	U001	22.00 x	41.00 x	— x	10.00 x	—
59378	UL	22.00 x	32.00 x	— x	6.00 x	8.00	54780	U002	22.00 x	41.00 x	— x	10.00 x	—
59378	UL	22.00 x	32.00 x	— x	6.00 x	8.00	8091	V	22.00 x	42.00 x	— x	9.00 x	—
54740	U004	22.00 x	32.00 x	— x	7.00 x	—	54781	U001	22.00 x	42.00 x	— x	10.00 x	—
3225	C	22.00 x	32.00 x	3.00 x	7.50 x	—	54782	U002	22.00 x	42.00 x	— x	10.00 x	—
54742	U	22.00 x	32.00 x	— x	8.00 x	—	54783	U019	22.00 x	42.00 x	— x	10.00 x	—
53133	U002	22.00 x	32.00 x	— x	8.00 x	—	54784	U001	22.00 x	43.00 x	— x	10.00 x	—
54741	U004	22.00 x	32.00 x	— x	8.00 x	—	54785	U002	22.00 x	43.00 x	— x	10.00 x	—
54743	U002	22.00 x	32.00 x	— x	8.50 x	—	54786	U001	22.00 x	45.00 x	— x	11.00 x	—
54744	U004	22.00 x	32.00 x	— x	9.00 x	—	54787	U002	22.00 x	45.00 x	— x	11.00 x	—
54745	U007	22.00 x	32.00 x	— x	9.50 x	—	54790	U001	22.00 x	46.00 x	— x	12.00 x	—
54746	U008	22.00 x	32.00 x	— x	9.50 x	—	54789	U001	22.00 x	46.00 x	— x	12.00 x	—
3544	C	22.00 x	32.00 x	— x	10.00 x	—	54791	U002	22.00 x	46.00 x	— x	12.00 x	—
53430	U005	22.00 x	32.00 x	— x	10.00 x	—	54792	U001	22.00 x	46.00 x	— x	15.00 x	—
53430	U005	22.00 x	32.00 x	— x	10.00 x	8.50	54793	U002	22.00 x	46.00 x	— x	15.00 x	—
54747	U007	22.00 x	32.00 x	— x	12.00 x	—	54794	U001	22.00 x	52.00 x	— x	15.00 x	—
54748	U008	22.00 x	32.00 x	— x	12.00 x	—	54795	U002	22.00 x	52.00 x	— x	15.00 x	—
6340	CH	22.00 x	32.00 x	— x	20.00 x	—	54796	U001	22.00 x	72.00 x	— x	15.00 x	—
55751	U	22.00 x	32.50 x	— x	10.00 x	—	54797	U002	22.00 x	72.00 x	— x	15.00 x	—
55751	U031	22.00 x	32.50 x	— x	10.00 x	—	3473	C	22.00 x	89.00 x	3.50 x	21.00 x	—
55751	U04A	22.00 x	32.50 x	— x	10.00 x	—	3378	C	22.00 x	93.00 x	— x	12.50 x	—
54749	U002	22.00 x	33.50 x	— x	6.00 x	—	3442	C	22.00 x	99.00 x	5.50 x	11.90 x	—
50711	U006	22.00 x	33.50 x	— x	6.50 x	—	55621	U002	22.00 x	321.00 x	— x	7.30 x	—
52809	U002	22.00 x	33.80 x	— x	6.00 x	—	53060	U031	22.20 x	28.50 x	— x	4.70 x	—
F7440	J	22.00 x	34.00 x	34.00 x	5.50 x	8.50	54798	U001	22.20 x	29.00 x	— x	5.00 x	—
54750	U001	22.00 x	34.00 x	— x	6.00 x	—	54799	U002	22.20 x	29.00 x	— x	5.00 x	—
54751	U002	22.00 x	34.00 x	— x	6.00 x	—	53283	U04A	22.20 x	31.70 x	— x	4.76 x	—
54752	U003	22.00 x	34.00 x	— x	6.50 x	—	54800	U006	22.20 x	32.00 x	— x	10.00 x	—
52736	U002	22.00 x	34.00 x	— x	7.00 x	—	51913	U005	22.20 x	32.50 x	— x	4.40 x	—
54753	U004	22.00 x	34.00 x	— x	8.00 x	—	8150	V	22.20 x	34.50 x	— x	4.00 x	—
51559	U	22.00 x	34.00 x	— x	10.00 x	—	52080	U009	22.20 x	41.00 x	— x	7.30 x	—
54754	U001	22.00 x	34.00 x	— x	10.00 x	—	55635	U031	22.20 x	41.80 x	— x	18.00 x	—
54755	U004	22.00 x	34.00 x	— x	10.00 x	—	3155	C	22.20 x	63.00 x	3.50 x	10.00 x	—
51558	UL	22.00 x	34.00 x	— x	10.00 x	—	50158	U004	22.22 x	28.57 x	— x	3.17 x	—
53398	U065	22.00 x	34.50 x	— x	5.50 x	—	50336	U04A	22.22 x	28.57 x	— x	6.35 x	—
54756	U001	22.00 x	35.00 x	— x	7.00 x	—	50187	U051	22.22 x	30.16 x	— x	6.35 x	—
54757	U002	22.00 x	35.00 x	— x	7.00 x	—	50421	U051	22.22 x	31.75 x	— x	4.76 x	—
51817	U002	22.00 x	35.00 x	— x	7.50 x	—	52819	U001	22.22 x	31.75 x	— x	5.16 x	—
54758	U019	22.00 x	35.00 x	— x	7.50 x	—	51166	U	22.22 x	31.75 x	— x	7.94 x	—
54759	U001	22.00 x	35.00 x	— x	8.00 x	—	51166	U04A	22.22 x	31.75 x	— x	7.94 x	—
51674	U007	22.00 x	35.00 x	— x	9.00 x	6.00	50479	U019	22.22 x	31.75 x	— x	13.49 x	—
50521	U002	22.00 x	35.00 x	— x	10.00 x	—	59352	UL	22.22 x	32.50 x	— x	5.50 x	8.50
54760	U004	22.00 x	35.00 x	— x	10.00 x	—	F1763	W	22.22 x	34.92 x	— x	3.50 x	4.00
6189	CH	22.00 x	35.00 x	— x	18.00 x	—	8025	V	22.22 x	34.92 x	— x	4.76 x	—
6189	CH	22.00 x	35.00 x	— x	20.00 x	—	50732	U	22.22 x	34.92 x	— x	7.94 x	—
54761	U005	22.00 x	35.50 x	— x	7.00 x	—	50200	U040	22.22 x	34.92 x	— x	9.52 x	—
54762	U031	22.00 x	35.50 x	— x	8.00 x	—	3085	C	22.22 x	34.92 x	— x	10.32 x	—
54763	U001	22.00 x	36.00 x	— x	8.00 x	—	51203	U	22.22 x	38.10 x	— x	4.76 x	—
54764	U002	22.00 x	36.00 x	— x	8.00 x	—	F3357	W	22.22 x	38.10 x	— x	5.50 x	4.50
54765	U007	22.00 x	36.00 x	— x	9.50 x	—	8207	V	22.22 x	38.10 x	— x	7.14 x	—
54766	U008	22.00 x	36.00 x	— x	9.50 x	—	8090	V	22.22 x	47.62 x	— x	10.32 x	—
54767	U002	22.00 x	36.50 x	— x	6.50 x	—	51931	U001	22.23 x	28.58 x	— x	3.17 x	—
54768	U001	22.00 x	38.00 x	— x	8.00 x	—	54801	U005	22.23 x	31.75 x	— x	4.76 x	—
54769	U002	22.00 x	38.00 x	— x	8.00 x	—	52819	U001	22.23 x	31.75 x	— x	5.16 x	—
51165	U04A	22.00 x	38.00 x	— x	8.00 x	—	54802	U003	22.23 x	31.75 x	— x	5.16 x	—
51165	U04A	22.00 x	38.00 x	— x	8.00 x	—	54803	U031	22.23 x	31.75 x	— x	6.35 x	—
54770	U004	22.00 x	38.00 x	— x	10.00 x	—	52775	U	22.23 x	31.75 x	— x	7.94 x	—
54771	U001	22.00 x	38.00 x	— x	15.00 x	—	—	CH	22.23 x	31.75 x	— x	27.50 x	—
54772	U002	22.00 x	38.00 x	— x	15.00 x	—	54804	U005	22.23 x	32.00 x	— x	10.00 x	—



Cód	Mod	Di x	De x	Esp. x	Ha1 x	Ha2	Cód	Mod	Di x	De x	Esp. x	Ha1 x	Ha2
54805	U002	22.23 x	34.93 x	— x	6.35 x	—	51164	U031	23.30 x	31.75 x	— x	5.00 x	—
52047	U007	22.23 x	34.93 x	— x	6.35 x	—	51857	U007	23.50 x	31.00 x	— x	4.00 x	4.70
54806	U019	22.23 x	34.93 x	— x	6.35 x	—	54836	U007	23.50 x	31.00 x	— x	4.50 x	—
6063	CH	22.23 x	34.93 x	— x	9.53 x	—	54837	U001	23.50 x	31.50 x	— x	5.00 x	—
54807	U019	22.23 x	38.10 x	— x	7.94 x	—	54838	U007	23.50 x	31.50 x	— x	5.50 x	—
53193	U004	22.23 x	38.10 x	— x	12.70 x	—	54839	U	23.50 x	31.70 x	— x	5.10 x	—
—	CH	22.23 x	41.28 x	— x	31.00 x	—	50222	U031	23.50 x	31.70 x	— x	5.10 x	—
6043	CH	22.23 x	47.63 x	— x	28.58 x	—	50222	U031	23.50 x	31.70 x	— x	5.10 x	—
6024	CH	22.26 x	41.28 x	— x	31.75 x	—	50897	U031	23.50 x	32.50 x	— x	6.00 x	—
51609	U	22.35 x	28.44 x	— x	6.35 x	—	50653	U005	23.50 x	33.00 x	— x	12.00 x	11.00
51609	U04A	22.35 x	28.44 x	— x	6.35 x	—	51219	U	23.50 x	34.50 x	— x	5.40 x	6.40
51610	U	22.35 x	35.05 x	— x	9.60 x	—	59424	U020	23.50 x	37.00 x	— x	4.50 x	5.00
51610	U	22.35 x	35.05 x	— x	9.60 x	—	54840	U004	23.50 x	42.00 x	— x	10.00 x	—
50323	U019	22.40 x	33.40 x	— x	7.00 x	—	3281	C	23.50 x	124.00 x	— x	18.00 x	—
54808	U001	22.50 x	29.00 x	— x	6.00 x	—	3242	C	23.80 x	44.00 x	3.00 x	26.00 x	—
51258	U013	22.50 x	29.15 x	— x	7.90 x	—	54841	U002	23.81 x	31.75 x	— x	4.37 x	—
54809	U004	22.50 x	30.00 x	— x	5.00 x	—	50286	U004	23.81 x	31.75 x	— x	4.76 x	—
51797	U04A	22.50 x	31.90 x	— x	6.00 x	—	52042	U	23.81 x	33.34 x	— x	7.94 x	—
54810	U001	22.50 x	32.00 x	— x	8.00 x	—	54842	U007	23.81 x	34.93 x	— x	6.35 x	—
54811	U002	22.50 x	32.00 x	— x	8.00 x	—	—	U04A	23.81 x	36.51 x	— x	9.52 x	—
51170	U013	22.50 x	32.50 x	— x	4.70 x	—	54843	U019	23.81 x	39.69 x	— x	7.94 x	—
54812	U002	22.50 x	37.50 x	— x	8.00 x	—	54844	U019	23.81 x	41.28 x	— x	9.53 x	—
—	CH	22.50 x	40.50 x	— x	40.00 x	—	59320	U04A	23.81 x	44.45 x	— x	9.53 x	—
50304	U026	22.50 x	41.50 x	— x	10.00 x	—	3002	C	23.81 x	53.97 x	4.20 x	7.94 x	—
51095	U003	22.60 x	42.30 x	— x	10.40 x	—	54845	U001	24.00 x	30.00 x	— x	5.00 x	—
F3743	W	22.80 x	34.40 x	— x	6.10 x	5.30	54846	U002	24.00 x	30.00 x	— x	5.00 x	—
52064	U	22.90 x	28.30 x	— x	5.50 x	4.50	50055	U003	24.00 x	30.00 x	— x	5.00 x	—
51048	U003	23.00 x	29.00 x	— x	6.00 x	—	50055	U003	24.00 x	30.00 x	— x	5.00 x	—
51013	U002	23.00 x	30.00 x	— x	3.50 x	—	54847	U007	24.00 x	30.00 x	— x	5.00 x	—
50146	U031	23.00 x	30.00 x	— x	5.00 x	—	54848	U008	24.00 x	30.00 x	— x	5.00 x	—
52753	U021	23.00 x	30.20 x	— x	6.10 x	4.50	54849	U001	24.00 x	30.00 x	— x	6.00 x	—
54813	U005	23.00 x	30.50 x	— x	5.50 x	—	52018	U005	24.00 x	30.00 x	— x	7.00 x	9.00
54814	U006	23.00 x	31.00 x	— x	5.50 x	—	54850	U001	24.00 x	31.00 x	— x	5.00 x	—
54816	U004	23.00 x	31.00 x	— x	12.00 x	—	53275	U028	24.00 x	31.00 x	— x	5.50 x	—
51104	U002	23.00 x	31.50 x	— x	5.50 x	—	53240	U04A	24.00 x	31.00 x	— x	6.00 x	—
50167	U005	23.00 x	31.60 x	— x	6.30 x	—	53313	U032	24.00 x	31.50 x	— x	4.30 x	—
54817	U001	23.00 x	32.00 x	— x	5.00 x	—	50318	U008	24.00 x	31.50 x	— x	5.50 x	—
54818	U002	23.00 x	32.00 x	— x	5.00 x	—	54852	U031	24.00 x	31.50 x	— x	6.00 x	—
54819	U002	23.00 x	32.00 x	— x	8.00 x	—	51194	U003	24.00 x	32.00 x	— x	3.50 x	—
59403	UL	23.00 x	33.00 x	— x	5.00 x	8.00	51194	U003	24.00 x	32.00 x	— x	3.50 x	—
59403	UL	23.00 x	33.00 x	— x	5.00 x	8.00	51194	U003	24.00 x	32.00 x	— x	3.50 x	—
51281	U	23.00 x	35.00 x	— x	6.50 x	—	55658	U	24.00 x	32.00 x	— x	4.00 x	—
54820	U001	23.00 x	35.00 x	— x	10.00 x	—	54853	U001	24.00 x	32.00 x	— x	4.00 x	—
54821	U002	23.00 x	35.00 x	— x	10.00 x	—	54854	U002	24.00 x	32.00 x	— x	5.00 x	—
54822	U002	23.00 x	36.00 x	— x	6.00 x	—	51226	U	24.00 x	32.00 x	— x	5.50 x	4.00
—	CH	23.00 x	36.00 x	— x	29.00 x	—	54855	U005	24.00 x	32.00 x	— x	5.50 x	—
54823	U005	23.00 x	37.00 x	— x	9.50 x	—	51226	U031	24.00 x	32.00 x	— x	5.50 x	—
54824	U006	23.00 x	37.00 x	— x	9.50 x	—	52510	U001	24.00 x	32.00 x	— x	6.00 x	—
54825	U001	23.00 x	37.00 x	— x	10.00 x	—	51149	U003	24.00 x	32.00 x	— x	6.70 x	—
54826	U002	23.00 x	37.00 x	— x	10.00 x	—	52041	U002	24.00 x	32.00 x	— x	7.00 x	—
54827	U005	23.00 x	37.00 x	— x	10.00 x	—	54856	U002	24.00 x	32.00 x	— x	7.00 x	—
54828	U006	23.00 x	37.00 x	— x	10.00 x	—	54857	U007	24.00 x	32.00 x	— x	7.00 x	—
50039	U003	23.00 x	38.00 x	— x	11.00 x	—	54858	U008	24.00 x	32.00 x	— x	7.00 x	—
—	CH	23.00 x	39.00 x	— x	38.00 x	—	54859	U007	24.00 x	32.00 x	— x	8.00 x	—
54829	U002	23.00 x	40.00 x	— x	4.00 x	—	54860	U008	24.00 x	32.00 x	— x	8.00 x	—
54830	U001	23.00 x	40.00 x	— x	10.00 x	—	3395	C	24.00 x	32.00 x	— x	10.70 x	—
54831	U002	23.00 x	40.00 x	— x	10.00 x	—	52371	U041	24.00 x	32.50 x	— x	4.00 x	3.00
50313	U002	23.00 x	41.50 x	— x	8.00 x	—	52670	U002	24.00 x	32.50 x	— x	5.00 x	3.00
53213	U	23.00 x	43.00 x	— x	9.00 x	—	59408	UL	24.00 x	32.50 x	— x	6.00 x	8.30
54832	U001	23.00 x	43.00 x	— x	10.00 x	—	52125	U	24.00 x	33.00 x	— x	4.50 x	—
54833	U002	23.00 x	43.00 x	— x	10.00 x	—	52125	U	24.00 x	33.00 x	— x	4.50 x	—
53323	U04A	23.00 x	44.00 x	— x	8.00 x	—	54861	U007	24.00 x	33.00 x	— x	6.50 x	—
3065	C	23.00 x	50.00 x	3.00 x	9.50 x	—	51032	U040	24.00 x	33.00 x	— x	9.50 x	—
54834	U001	23.00 x	55.00 x	— x	12.00 x	—	50825	U	24.00 x	34.00 x	— x	4.00 x	—
54835	U002	23.00 x	55.00 x	— x	12.00 x	—	54862	U001	24.00 x	34.00 x	— x	5.00 x	—
50880	U	23.20 x	29.20 x	— x	3.20 x	—	54863	U002	24.00 x	34.00 x	— x	5.00 x	—
50172	U005	23.20 x	38.90 x	— x	9.00 x	—	50932	U	24.00 x	34.00 x	— x	6.00 x	—





Cód	Mod	Di x	De x	Esp. x	Ha1 x	Ha2	Cód	Mod	Di x	De x	Esp. x	Ha1 x	Ha2
50932	U019	24.00 x	34.00 x	— x	6.00 x	—	59262	U047	24.80 x	36.90 x	— x	9.00 x	—
50374	U040	24.00 x	34.00 x	— x	9.50 x	—	52355	U011	25.00 x	30.00 x	— x	6.00 x	—
54864	U005	24.00 x	34.00 x	— x	11.00 x	—	54893	U031	25.00 x	30.50 x	— x	9.00 x	—
—	CH	24.00 x	34.00 x	— x	24.50 x	—	51743	U001	25.00 x	31.30 x	— x	3.50 x	—
59390	UL	24.00 x	35.00 x	— x	5.00 x	6.00	54894	U002	25.00 x	31.30 x	— x	3.50 x	—
50898	U002	24.00 x	35.00 x	— x	6.00 x	—	52900	U	25.00 x	31.70 x	— x	3.50 x	—
54865	U005	24.00 x	35.00 x	— x	6.00 x	—	8373	V	25.00 x	32.00 x	— x	1.30 x	—
54866	U007	24.00 x	35.00 x	— x	6.00 x	—	50934	U031	25.00 x	32.00 x	— x	3.00 x	—
51045	U041	24.00 x	35.00 x	— x	6.00 x	—	53342	U	25.00 x	32.00 x	— x	4.00 x	—
51366	U	24.00 x	35.00 x	— x	6.40 x	—	52939	U	25.00 x	32.00 x	— x	6.00 x	—
52286	U	24.00 x	35.00 x	— x	6.50 x	—	52939	U	25.00 x	32.00 x	— x	6.00 x	—
50190	U002	24.00 x	35.00 x	— x	8.00 x	—	54895	U004	25.00 x	32.00 x	— x	6.00 x	—
52843	U002	24.00 x	35.50 x	— x	6.00 x	—	54896	U007	25.00 x	32.00 x	— x	7.60 x	—
50561	U002	24.00 x	36.00 x	— x	6.30 x	—	54897	U008	25.00 x	32.00 x	— x	7.60 x	—
—	U04A	24.00 x	36.50 x	— x	9.00 x	—	54898	U	25.00 x	32.00 x	— x	9.00 x	—
51018	U002	24.00 x	37.00 x	— x	6.00 x	—	51861	U	25.00 x	32.00 x	— x	12.00 x	—
51423	U002	24.00 x	37.50 x	— x	6.00 x	—	51991	U032	25.00 x	32.25 x	— x	3.00 x	—
—	CH	24.00 x	37.50 x	— x	28.00 x	—	50198	U002	25.00 x	32.30 x	— x	5.00 x	—
52308	U054	24.00 x	39.00 x	— x	9.00 x	—	51601	U04A	25.00 x	32.50 x	— x	5.20 x	—
8000	V	24.00 x	40.00 x	— x	7.50 x	—	54899	U003	25.00 x	32.50 x	— x	6.00 x	—
52028	U	24.00 x	40.00 x	— x	8.00 x	—	55701	U	25.00 x	32.75 x	— x	4.76 x	6.35
54867	U001	24.00 x	40.00 x	— x	8.00 x	—	50536	U004	25.00 x	33.00 x	— x	4.00 x	—
50073	U002	24.00 x	40.00 x	— x	8.00 x	—	50573	U031	25.00 x	33.00 x	— x	4.30 x	—
50073	U002	24.00 x	40.00 x	— x	8.00 x	—	50933	U009	25.00 x	33.00 x	— x	4.50 x	—
51573	U001	24.00 x	40.00 x	— x	8.50 x	—	52290	U	25.00 x	33.00 x	— x	5.00 x	—
50088	U002	24.00 x	40.00 x	— x	8.50 x	—	52290	U004	25.00 x	33.00 x	— x	5.00 x	—
50092	U019	24.00 x	40.00 x	— x	8.50 x	—	52105	U	25.00 x	33.00 x	— x	5.50 x	—
50092	U019	24.00 x	40.00 x	— x	8.50 x	—	54900	U005	25.00 x	33.00 x	— x	5.50 x	—
54868	U004	24.00 x	40.00 x	— x	10.00 x	—	52075	U	25.00 x	33.00 x	— x	6.00 x	—
54869	U001	24.00 x	40.00 x	— x	12.00 x	—	52075	U002	25.00 x	33.00 x	— x	6.00 x	—
—	CH	24.00 x	40.00 x	— x	27.00 x	—	52481	U04A	25.00 x	33.00 x	— x	6.00 x	—
—	CH	24.00 x	40.00 x	— x	38.00 x	—	54901	U001	25.00 x	33.00 x	— x	7.00 x	—
F42	J	24.00 x	40.50 x	— x	7.00 x	9.50	54902	U031	25.00 x	33.00 x	— x	7.00 x	—
50589	U001	24.00 x	41.00 x	— x	8.00 x	—	52525	U	25.00 x	33.00 x	— x	8.00 x	—
54870	U001	24.00 x	44.00 x	— x	10.00 x	—	52297	U004	25.00 x	33.00 x	— x	8.00 x	5.00
51411	U002	24.00 x	44.00 x	— x	10.00 x	—	54903	U006	25.00 x	33.00 x	— x	8.00 x	—
54871	U001	24.00 x	45.00 x	— x	15.00 x	—	52294	U054	25.00 x	33.00 x	— x	8.00 x	—
54872	U002	24.00 x	45.00 x	— x	15.00 x	—	52525	UL	25.00 x	33.00 x	— x	8.00 x	5.00
54873	U001	24.00 x	48.00 x	— x	10.00 x	—	54904	U006	25.00 x	33.00 x	— x	10.00 x	—
54874	U002	24.00 x	48.00 x	— x	10.00 x	—	52690	U029	25.00 x	33.00 x	— x	10.70 x	—
54875	U001	24.00 x	48.00 x	— x	12.50 x	—	51790	U008	25.00 x	33.30 x	— x	5.00 x	—
54876	U002	24.00 x	48.00 x	— x	12.50 x	—	54905	U031	25.00 x	33.50 x	— x	4.50 x	—
54877	U001	24.00 x	50.00 x	— x	12.00 x	—	52706	U006	25.00 x	33.50 x	— x	9.55 x	—
54878	U002	24.00 x	50.00 x	— x	12.00 x	—	51704	U054	25.00 x	34.00 x	— x	5.50 x	—
54879	U001	24.00 x	60.00 x	— x	15.00 x	—	50657	U031	25.00 x	34.00 x	— x	6.00 x	—
54880	U002	24.00 x	60.00 x	— x	15.00 x	—	50537	U046	25.00 x	34.00 x	— x	7.00 x	—
59446	U	24.20 x	30.00 x	— x	4.40 x	—	50819	U031	25.00 x	34.50 x	— x	5.00 x	—
55638	UL	24.40 x	33.50 x	— x	5.30 x	7.20	53246	UL	25.00 x	34.50 x	— x	5.00 x	7.00
54881	U001	24.50 x	31.00 x	— x	3.00 x	—	59388	UL	25.00 x	34.50 x	— x	5.00 x	7.00
54882	U003	24.50 x	34.50 x	— x	5.00 x	—	53246	UL	25.00 x	34.50 x	— x	7.00 x	—
54883	U002	24.50 x	35.00 x	— x	6.00 x	—	51368	U	25.00 x	35.00 x	— x	5.00 x	—
54884	U008	24.50 x	35.00 x	— x	6.00 x	—	51127	U001	25.00 x	35.00 x	— x	5.00 x	—
52010	U002	24.50 x	35.50 x	— x	7.00 x	—	51200	U002	25.00 x	35.00 x	— x	5.00 x	—
52664	U	24.50 x	36.60 x	— x	7.20 x	—	51200	U002	25.00 x	35.00 x	— x	5.00 x	—
54885	U005	24.50 x	37.00 x	— x	6.00 x	—	53049	U031	25.00 x	35.00 x	— x	5.00 x	—
54886	U002	24.50 x	38.00 x	— x	8.00 x	—	59391	UL	25.00 x	35.00 x	— x	5.00 x	6.50
54887	U001	24.50 x	39.00 x	— x	11.00 x	—	59361	UL	25.00 x	35.00 x	— x	5.00 x	8.50
54888	U002	24.50 x	39.00 x	— x	11.00 x	—	59359	UL	25.00 x	35.00 x	— x	5.00 x	8.50
59313	U004	24.50 x	39.50 x	— x	9.20 x	—	8219	V	25.00 x	35.00 x	— x	5.00 x	—
54889	U031	24.50 x	40.00 x	— x	6.00 x	—	54906	U	25.00 x	35.00 x	— x	5.50 x	7.00
8082	V	24.50 x	40.00 x	— x	8.30 x	—	52039	U065	25.00 x	35.00 x	— x	5.50 x	—
8082	V	24.50 x	40.00 x	— x	8.30 x	—	50592	U031	25.00 x	35.00 x	— x	5.70 x	—
54890	U005	24.50 x	45.00 x	— x	10.00 x	—	50592	U031	25.00 x	35.00 x	— x	5.70 x	—
51443	U003	24.60 x	39.68 x	— x	6.30 x	—	54907	U002	25.00 x	35.00 x	— x	6.00 x	—
54891	U008	24.61 x	34.93 x	— x	6.75 x	—	53011	UL	25.00 x	35.00 x	— x	6.00 x	—
54892	U	24.80 x	33.30 x	— x	2.50 x	4.70	53011	UL	25.00 x	35.00 x	— x	6.00 x	7.50
50555	U054	24.80 x	33.30 x	— x	4.70 x	2.50	51204	U	25.00 x	35.00 x	— x	6.35 x	—



Cód	Mod	Di x	De x	Esp. x	Ha1 x	Ha2	Cód	Mod	Di x	De x	Esp. x	Ha1 x	Ha2
51024	U004	25.00 x	35.00 x	— x	6.35 x	—	50082	U040	25.00 x	40.00 x	— x	10.00 x	—
51024	U04A	25.00 x	35.00 x	— x	6.35 x	—	53308	U046	25.00 x	40.00 x	— x	10.00 x	—
50575	U004	25.00 x	35.00 x	— x	6.50 x	—	54929	U001	25.00 x	40.00 x	— x	11.00 x	—
54908	U007	25.00 x	35.00 x	— x	6.50 x	—	54930	U002	25.00 x	40.00 x	— x	11.00 x	—
52869	U	25.00 x	35.00 x	— x	7.00 x	—	54931	U004	25.00 x	40.00 x	— x	11.00 x	—
52650	U002	25.00 x	35.00 x	— x	7.00 x	—	53282	U04A	25.00 x	40.00 x	— x	12.00 x	—
50565	U006	25.00 x	35.00 x	— x	7.00 x	5.50	6305	CH	25.00 x	40.00 x	— x	22.20 x	—
54909	U006	25.00 x	35.00 x	— x	7.00 x	6.00	54932	U	25.00 x	41.00 x	— x	8.00 x	—
50816	U016	25.00 x	35.00 x	— x	7.00 x	4.00	8255	V	25.00 x	41.00 x	— x	8.50 x	—
50307	U046	25.00 x	35.00 x	— x	7.00 x	—	8022	V	25.00 x	41.00 x	— x	9.00 x	—
51647	U085	25.00 x	35.00 x	— x	7.00 x	—	8345	V	25.00 x	41.50 x	— x	8.00 x	—
55563	U	25.00 x	35.00 x	— x	7.30 x	—	—	CH	25.00 x	41.50 x	— x	33.50 x	—
55563	U04A	25.00 x	35.00 x	— x	7.30 x	—	8008	V	25.00 x	42.00 x	— x	7.50 x	—
53011	UL	25.00 x	35.00 x	— x	7.50 x	—	51607	U002	25.00 x	42.00 x	— x	8.00 x	—
52038	U002	25.00 x	35.00 x	— x	8.00 x	—	54934	U019	25.00 x	42.00 x	— x	8.00 x	—
51050	U	25.00 x	35.00 x	— x	8.50 x	—	54935	U001	25.00 x	42.00 x	— x	8.50 x	—
54910	U001	25.00 x	35.00 x	— x	8.50 x	—	54936	U002	25.00 x	42.00 x	— x	8.50 x	—
51263	U004	25.00 x	35.00 x	— x	8.50 x	—	54937	U002	25.00 x	42.00 x	— x	10.00 x	—
54911	U004	25.00 x	35.00 x	— x	8.50 x	—	3375	C	25.00 x	42.50 x	— x	7.50 x	—
51050	U004	25.00 x	35.00 x	— x	8.50 x	—	8110	V	25.00 x	44.50 x	— x	9.00 x	—
52124	U006	25.00 x	35.00 x	— x	8.50 x	—	8110	V	25.00 x	44.50 x	— x	9.00 x	—
50862	U006	25.00 x	35.00 x	— x	8.50 x	—	6036	CH	25.00 x	44.50 x	— x	28.00 x	—
52902	U007	25.00 x	35.00 x	— x	9.50 x	—	54938	U007	25.00 x	45.00 x	— x	7.50 x	—
52902	UL	25.00 x	35.00 x	— x	9.50 x	—	54939	U001	25.00 x	45.00 x	— x	8.00 x	—
54912	U001	25.00 x	35.00 x	— x	10.00 x	—	3400	C	25.00 x	45.00 x	2.50 x	10.00 x	—
54913	U002	25.00 x	35.00 x	— x	10.00 x	—	3058	C	25.00 x	45.00 x	3.00 x	10.00 x	—
54914	U004	25.00 x	35.00 x	— x	10.00 x	—	3400	C	25.00 x	45.00 x	2.50 x	10.00 x	—
6257	CH	25.00 x	35.00 x	— x	10.00 x	—	50765	U002	25.00 x	45.00 x	— x	10.00 x	—
6377	CH	25.00 x	35.00 x	— x	13.00 x	—	54940	U002	25.00 x	45.00 x	— x	10.00 x	—
6377	CH	25.00 x	35.00 x	— x	13.00 x	—	51197	U003	25.00 x	45.00 x	— x	10.00 x	—
6257	CH	25.00 x	35.00 x	— x	15.00 x	—	54941	U004	25.00 x	45.00 x	— x	10.00 x	—
6377	CH	25.00 x	35.00 x	— x	15.00 x	—	54942	U006	25.00 x	45.00 x	— x	10.00 x	—
51055	U031	25.00 x	36.00 x	— x	7.00 x	—	54943	U019	25.00 x	45.00 x	— x	10.00 x	—
54915	U004	25.00 x	36.00 x	— x	8.50 x	—	8246	V	25.00 x	45.00 x	— x	10.00 x	—
52730	U031	25.00 x	37.00 x	— x	2.60 x	—	8075	V	25.00 x	45.00 x	— x	10.00 x	—
54916	U006	25.00 x	37.00 x	— x	6.00 x	—	51584	U001	25.00 x	45.00 x	— x	12.00 x	—
54917	U006	25.00 x	37.00 x	— x	6.00 x	—	54945	U002	25.00 x	45.00 x	— x	15.00 x	—
50507	U002	25.00 x	37.00 x	— x	6.30 x	—	—	CH	25.00 x	45.00 x	— x	51.50 x	—
50507	U002	25.00 x	37.00 x	— x	6.30 x	—	54946	U001	25.00 x	46.00 x	— x	10.00 x	—
52281	U	25.00 x	37.00 x	— x	6.50 x	—	54947	U002	25.00 x	46.00 x	— x	10.00 x	—
52281	U001	25.00 x	37.00 x	— x	6.50 x	—	50262	U002	25.00 x	47.00 x	— x	7.00 x	—
6166	CH	25.00 x	37.00 x	— x	18.00 x	—	54948	U001	25.00 x	47.00 x	— x	10.00 x	—
52413	U003	25.00 x	37.50 x	— x	5.00 x	6.50	54949	U002	25.00 x	47.00 x	— x	10.00 x	—
54918	U007	25.00 x	37.50 x	— x	12.00 x	—	54950	U003	25.00 x	50.00 x	— x	9.00 x	—
52958	U	25.00 x	38.00 x	— x	6.00 x	—	3042	C	25.00 x	50.00 x	3.00 x	12.00 x	—
54919	U002	25.00 x	38.00 x	— x	6.50 x	—	54951	U001	25.00 x	50.00 x	— x	12.00 x	—
51858	U	25.00 x	38.00 x	— x	7.00 x	—	52582	U002	25.00 x	50.00 x	— x	12.00 x	—
54920	U001	25.00 x	38.00 x	— x	7.00 x	—	54952	U019	25.00 x	50.00 x	— x	12.00 x	—
54921	U002	25.00 x	38.00 x	— x	7.00 x	—	51270	U074	25.00 x	50.50 x	— x	15.00 x	—
54922	U004	25.00 x	38.00 x	— x	10.00 x	—	3468	C	25.00 x	51.00 x	4.00 x	8.00 x	—
6381	CH	25.00 x	38.00 x	— x	22.00 x	—	54953	U001	25.00 x	52.00 x	— x	12.00 x	—
52942	U001	25.00 x	39.00 x	— x	6.50 x	—	54954	U002	25.00 x	52.00 x	— x	12.00 x	—
54923	U031	25.00 x	39.00 x	— x	8.00 x	—	3316	C	25.00 x	54.50 x	— x	10.50 x	—
—	CH	25.00 x	39.00 x	— x	35.50 x	—	3529	C	25.00 x	55.00 x	3.50 x	11.00 x	—
54924	U002	25.00 x	39.50 x	— x	10.00 x	—	3398	C	25.00 x	55.00 x	4.50 x	12.00 x	—
54925	U002	25.00 x	40.00 x	— x	6.00 x	—	54955	U001	25.00 x	55.00 x	— x	20.00 x	—
54926	U019	25.00 x	40.00 x	— x	6.00 x	—	54956	U002	25.00 x	55.00 x	— x	20.00 x	—
8347	V	25.00 x	40.00 x	— x	7.00 x	—	3022	C	25.00 x	60.00 x	5.00 x	20.00 x	—
50120	U026	25.00 x	40.00 x	— x	7.50 x	—	6269	CH	25.00 x	60.00 x	— x	32.00 x	—
54927	U002	25.00 x	40.00 x	— x	9.50 x	—	3025	C	25.00 x	69.50 x	4.00 x	13.50 x	—
59244	UL	25.00 x	40.00 x	— x	9.50 x	—	3020	C	25.00 x	69.95 x	— x	17.50 x	—
51373	U002	25.00 x	40.00 x	— x	10.00 x	—	3329	C	25.00 x	130.00 x	3.00 x	12.00 x	—
52974	U003	25.00 x	40.00 x	— x	10.00 x	—	3531	C	25.00 x	152.40 x	4.00 x	15.80 x	—
52974	U005	25.00 x	40.00 x	— x	10.00 x	—	52455	U	25.30 x	38.00 x	— x	7.90 x	—
52686	U011	25.00 x	40.00 x	— x	10.00 x	—	51981	U002	25.30 x	51.20 x	— x	7.80 x	—
52219	U031	25.00 x	40.00 x	— x	10.00 x	—	53519	U04A	25.40 x	31.00 x	— x	3.50 x	—
50082	U040	25.00 x	40.00 x	— x	10.00 x	—	52827	U04A	25.40 x	31.20 x	— x	6.70 x	—



Cód	Mod	Di x	De x	Esp. x	Ha1 x	Ha2	Cód	Mod	Di x	De x	Esp. x	Ha1 x	Ha2
53340	U002	25.40 x	31.75 x	— x	3.17 x	—	54966	U002	25.40 x	37.70 x	— x	6.50 x	—
50204	U004	25.40 x	31.75 x	— x	3.17 x	—	8353	V	25.40 x	38.10 x	— x	3.55 x	—
54958	U004	25.40 x	31.75 x	— x	3.30 x	—	54967	U002	25.40 x	38.10 x	— x	3.97 x	—
51826	U	25.40 x	31.75 x	— x	4.76 x	—	8179	V	25.40 x	38.10 x	— x	3.97 x	—
50229	U004	25.40 x	31.75 x	— x	6.35 x	—	F694	W	25.40 x	38.10 x	— x	4.00 x	3.00
50229	U004	25.40 x	31.75 x	— x	6.35 x	—	8401	V	25.40 x	38.10 x	— x	4.37 x	—
50229	U004	25.40 x	31.75 x	— x	6.35 x	—	8404	V	25.40 x	38.10 x	— x	4.50 x	—
51051	U004	25.40 x	31.75 x	— x	6.35 x	—	8063	V	25.40 x	38.10 x	— x	4.76 x	—
50229	U004	25.40 x	31.75 x	— x	6.35 x	—	F891	W	25.40 x	38.10 x	— x	5.00 x	4.50
54959	U005	25.40 x	31.75 x	— x	6.35 x	—	8120	V	25.40 x	38.10 x	— x	6.00 x	—
51051	U04A	25.40 x	31.75 x	— x	6.35 x	—	53071	U002	25.40 x	38.10 x	— x	6.35 x	—
51051	U04A	25.40 x	31.75 x	— x	6.35 x	—	50351	U002	25.40 x	38.10 x	— x	6.35 x	—
51091	U004	25.40 x	32.50 x	— x	4.00 x	—	50207	U002	25.40 x	38.10 x	— x	6.35 x	—
52051	U	25.40 x	32.94 x	— x	3.96 x	—	53071	U002	25.40 x	38.10 x	— x	6.35 x	—
53006	U	25.40 x	32.94 x	— x	3.97 x	—	52923	U04A	25.40 x	38.10 x	— x	6.35 x	—
53006	U	25.40 x	32.94 x	— x	3.97 x	—	52923	U04A	25.40 x	38.10 x	— x	6.35 x	—
53006	U	25.40 x	32.94 x	— x	3.97 x	—	52923	U04A	25.40 x	38.10 x	— x	6.35 x	—
51599	U002	25.40 x	33.34 x	— x	3.97 x	—	52923	U04A	25.40 x	38.10 x	— x	6.35 x	—
51599	U002	25.40 x	33.34 x	— x	3.97 x	—	8259	V	25.40 x	38.10 x	— x	6.35 x	—
54960	U006	25.40 x	33.34 x	— x	5.56 x	—	54968	U001	25.40 x	38.10 x	— x	6.40 x	—
54961	U004	25.40 x	33.34 x	— x	5.95 x	—	54969	U006	25.40 x	38.10 x	— x	7.14 x	—
52734	U005	25.40 x	34.00 x	— x	10.00 x	—	3202	C	25.40 x	38.10 x	4.50 x	7.94 x	—
54962	U005	25.40 x	34.00 x	— x	10.00 x	—	54970	U002	25.40 x	38.10 x	— x	9.53 x	—
54963	U006	25.40 x	34.00 x	— x	10.00 x	—	54971	U003	25.40 x	38.10 x	— x	9.53 x	—
52991	U	25.40 x	34.13 x	— x	5.16 x	—	54972	U004	25.40 x	38.10 x	— x	9.53 x	—
52991	U002	25.40 x	34.13 x	— x	5.16 x	—	50749	U04A	25.40 x	38.10 x	— x	9.53 x	—
51346	U031	25.40 x	34.50 x	— x	4.70 x	—	50749	U04A	25.40 x	38.10 x	— x	9.53 x	—
51346	U031	25.40 x	34.50 x	— x	4.70 x	—	50805	U031	25.40 x	38.10 x	— x	10.00 x	—
6379	CH	25.40 x	34.60 x	— x	20.00 x	—	6215	CH	25.40 x	38.10 x	— x	10.50 x	—
6379	CH	25.40 x	34.60 x	— x	20.00 x	—	6028	CH	25.40 x	38.10 x	— x	11.11 x	—
8341	V	25.40 x	34.90 x	— x	3.97 x	—	6087	CH	25.40 x	38.10 x	— x	18.00 x	—
53070	U	25.40 x	34.90 x	— x	8.00 x	—	6087	CH	25.40 x	38.10 x	— x	19.05 x	—
53070	U04A	25.40 x	34.90 x	— x	8.00 x	—	6055	CH	25.40 x	38.10 x	— x	19.84 x	—
53070	U04A	25.40 x	34.90 x	— x	8.00 x	—	53043	U	25.40 x	38.40 x	— x	9.50 x	8.00
50505	U004	25.40 x	34.92 x	— x	4.76 x	—	52916	U	25.40 x	39.00 x	— x	9.50 x	—
50505	U004	25.40 x	34.92 x	— x	4.76 x	—	51105	U002	25.40 x	39.68 x	— x	5.55 x	—
50806	U016	25.40 x	34.92 x	— x	4.76 x	7.14	54973	U002	25.40 x	39.69 x	— x	5.56 x	—
50806	U016	25.40 x	34.92 x	— x	4.76 x	7.14	50339	U001	25.40 x	39.69 x	— x	7.94 x	—
59420	UL	25.40 x	34.92 x	— x	5.00 x	7.14	8085	V	25.40 x	41.27 x	— x	7.00 x	—
59379	UL	25.40 x	34.92 x	— x	5.56 x	7.94	6066	CH	25.40 x	41.28 x	— x	26.99 x	—
59365	UL	25.40 x	34.92 x	— x	5.56 x	7.97	—	CH	25.40 x	42.07 x	— x	34.50 x	—
52492	U031	25.40 x	34.92 x	— x	6.00 x	7.50	54975	U019	25.40 x	42.86 x	— x	9.53 x	—
52492	U031	25.40 x	34.92 x	— x	6.00 x	7.50	8067	V	25.40 x	44.45 x	— x	6.35 x	—
51052	U004	25.40 x	34.92 x	— x	7.94 x	—	8382	V	25.40 x	44.45 x	— x	7.14 x	—
F8774	W	25.40 x	34.92 x	— x	9.52 x	—	8382	V	25.40 x	44.45 x	— x	7.14 x	—
52162	U004	25.40 x	34.93 x	— x	4.76 x	—	51833	U003	25.40 x	44.45 x	— x	9.52 x	—
F8849	W	25.40 x	34.93 x	— x	6.35 x	—	6182	CH	25.40 x	44.45 x	— x	25.40 x	—
59381	UL	25.40 x	35.00 x	— x	4.70 x	8.00	6012	CH	25.40 x	44.45 x	— x	33.34 x	—
59381	UL	25.40 x	35.00 x	— x	4.70 x	8.00	3046	C	25.40 x	50.80 x	3.00 x	11.11 x	—
51891	U017	25.40 x	35.00 x	— x	5.00 x	—	52848	U002	25.40 x	50.80 x	— x	12.70 x	—
52428	U031	25.40 x	35.20 x	— x	5.00 x	—	3407	C	25.40 x	50.80 x	— x	14.70 x	—
52428	U04A	25.40 x	35.20 x	— x	5.00 x	—	3407	C	25.40 x	50.80 x	— x	14.70 x	—
52660	U031	25.40 x	35.40 x	— x	7.30 x	—	8089	V	25.40 x	51.59 x	— x	10.00 x	—
50899	U003	25.40 x	35.50 x	— x	7.50 x	—	6074	CH	25.40 x	51.59 x	— x	20.64 x	—
52756	U031	25.40 x	35.60 x	— x	10.00 x	—	3549	C	25.40 x	57.00 x	0.80 x	6.00 x	—
55591	U	25.40 x	36.00 x	— x	4.50 x	—	3122	C	25.40 x	75.20 x	3.00 x	15.00 x	—
50488	U008	25.40 x	36.00 x	— x	6.50 x	—	3474	C	25.40 x	76.20 x	— x	4.76 x	—
50924	U061	25.40 x	36.50 x	— x	7.14 x	—	3478	C	25.40 x	76.20 x	— x	12.70 x	—
50924	U061	25.40 x	36.50 x	— x	7.14 x	—	3409	C	25.40 x	76.20 x	3.00 x	15.80 x	—
F10947	W	25.40 x	36.51 x	— x	5.15 x	5.95	3198	C	25.40 x	82.55 x	3.50 x	9.52 x	—
F10947	W	25.40 x	36.51 x	— x	5.95 x	5.15	3248	C	25.40 x	85.00 x	— x	8.80 x	—
54964	U002	25.40 x	36.51 x	— x	6.35 x	—	3367	C	25.40 x	101.60 x	— x	25.40 x	—
50456	U007	25.40 x	36.51 x	— x	6.35 x	—	3391	C	25.40 x	207.00 x	5.00 x	30.00 x	—
52938	U002	25.40 x	37.00 x	— x	6.00 x	—	54977	U031	25.50 x	31.50 x	— x	5.00 x	—
6291	CH	25.40 x	37.00 x	— x	13.00 x	—	54978	U006	25.50 x	32.00 x	— x	5.50 x	—
54965	U	25.40 x	37.31 x	— x	6.35 x	—	54979	U004	25.50 x	32.00 x	— x	6.50 x	—
50394	U002	25.40 x	37.31 x	— x	6.35 x	—	54980	U004	25.50 x	32.50 x	— x	5.00 x	—



Cód	Mod	Di x	De x	Esp. x	Ha1 x	Ha2	Cód	Mod	Di x	De x	Esp. x	Ha1 x	Ha2
50682	U004	25.50 x	33.00 x	— x	4.60 x	—	F9934	J	26.00 x	51.00 x	— x	23.00 x	—
F9907	J	25.50 x	34.70 x	— x	8.50 x	10.00	3370	C	26.00 x	53.00 x	— x	10.00 x	—
F109	J	25.50 x	39.00 x	— x	8.40 x	13.50	50089	U001	26.00 x	60.00 x	— x	14.50 x	—
54981	U002	25.50 x	39.50 x	— x	11.00 x	—	55016	U001	26.00 x	60.00 x	— x	15.00 x	—
52687	U053	25.50 x	40.00 x	— x	8.00 x	10.00	55017	U002	26.00 x	60.00 x	— x	15.00 x	—
3014	C	25.50 x	45.00 x	3.00 x	12.00 x	—	55018	U001	26.00 x	64.00 x	— x	12.00 x	—
50801	U	25.80 x	38.00 x	— x	8.00 x	—	55019	U002	26.00 x	64.00 x	— x	12.00 x	—
54982	U002	25.80 x	46.50 x	— x	15.00 x	—	3520	C	26.00 x	90.00 x	— x	15.00 x	—
—	U	26.00 x	31.75 x	— x	4.00 x	—	3530	C	26.00 x	101.60 x	5.00 x	13.00 x	—
54983	U001	26.00 x	32.00 x	— x	6.00 x	—	55020	U04A	26.10 x	34.80 x	— x	8.20 x	—
54984	U002	26.00 x	32.00 x	— x	6.50 x	—	53013	U008	26.30 x	34.50 x	— x	10.00 x	9.00
54985	U002	26.00 x	32.00 x	— x	7.00 x	—	53013	U028	26.50 x	34.50 x	— x	9.00 x	—
51880	U004	26.00 x	33.00 x	— x	3.50 x	4.00	53013	U028	26.50 x	34.50 x	— x	10.00 x	—
51511	U004	26.00 x	33.00 x	— x	4.00 x	—	51930	U002	26.50 x	38.00 x	— x	7.50 x	—
54986	U007	26.00 x	33.00 x	— x	4.50 x	—	6319	CH	26.50 x	46.50 x	— x	45.00 x	—
54987	U006	26.00 x	33.00 x	— x	5.00 x	—	8026	V	26.80 x	40.10 x	— x	8.00 x	—
54988	U004	26.00 x	33.00 x	— x	7.00 x	—	50692	U008	26.90 x	33.30 x	— x	6.35 x	5.60
50049	U031	26.00 x	34.00 x	— x	5.00 x	—	53010	U	26.90 x	36.50 x	— x	4.70 x	—
53140	U001	26.00 x	34.00 x	— x	6.00 x	—	53010	U04A	26.90 x	36.50 x	— x	4.70 x	—
54989	U005	26.00 x	34.00 x	— x	9.00 x	—	51034	U	26.99 x	33.34 x	— x	6.35 x	—
54990	U006	26.00 x	34.00 x	— x	9.00 x	—	55021	U002	26.99 x	34.93 x	— x	3.97 x	—
51150	U	26.00 x	35.00 x	— x	6.00 x	7.00	55671	U04A	26.99 x	36.51 x	— x	4.76 x	—
54991	U001	26.00 x	35.00 x	— x	10.00 x	—	3141	C	26.99 x	38.10 x	— x	9.52 x	—
54992	U002	26.00 x	35.00 x	— x	10.00 x	—	55022	U004	26.99 x	38.10 x	— x	9.92 x	—
59384	UL	26.00 x	35.50 x	— x	5.50 x	7.00	8057	V	26.99 x	39.69 x	— x	4.76 x	—
54993	U004	26.00 x	36.00 x	— x	10.00 x	—	51881	U020	26.99 x	39.69 x	— x	6.35 x	—
50188	U004	26.00 x	36.00 x	— x	10.00 x	—	55023	U007	26.99 x	39.69 x	— x	7.94 x	—
F1013	J	26.00 x	36.00 x	— x	12.00 x	—	8142	V	26.99 x	39.69 x	— x	8.33 x	—
3072	C	26.00 x	36.80 x	1.00 x	12.00 x	—	6107	CH	26.99 x	39.69 x	— x	15.87 x	—
52995	U	26.00 x	37.00 x	— x	7.00 x	—	8036	V	26.99 x	44.45 x	— x	7.94 x	—
52995	U002	26.00 x	37.00 x	— x	7.00 x	—	55024	U019	26.99 x	46.04 x	— x	9.53 x	—
52992	U002	26.00 x	37.00 x	— x	7.00 x	—	55025	U005	27.00 x	34.00 x	— x	4.50 x	—
51526	U001	26.00 x	37.50 x	— x	6.00 x	—	52790	U031	27.00 x	35.00 x	— x	5.50 x	—
52221	U	26.00 x	37.50 x	— x	6.50 x	—	52790	U031	27.00 x	35.00 x	— x	5.50 x	—
8156	V	26.00 x	38.00 x	— x	4.00 x	—	55026	U002	27.00 x	35.00 x	— x	8.00 x	—
8156	V	26.00 x	38.00 x	— x	4.00 x	—	55027	U007	27.00 x	35.00 x	— x	10.00 x	—
54995	U001	26.00 x	38.00 x	— x	6.00 x	—	55028	U008	27.00 x	35.00 x	— x	10.00 x	—
54996	U002	26.00 x	38.00 x	— x	6.00 x	—	52987	U002	27.00 x	36.00 x	— x	5.00 x	—
50664	U021	26.00 x	38.00 x	— x	6.00 x	9.00	52987	U002	27.00 x	36.00 x	— x	5.00 x	—
54997	U007	26.00 x	38.00 x	— x	7.00 x	—	55029	U	27.00 x	36.00 x	— x	5.50 x	6.00
54998	U001	26.00 x	38.00 x	— x	8.00 x	—	55030	U001	27.00 x	36.00 x	— x	6.00 x	—
54999	U002	26.00 x	38.00 x	— x	8.00 x	—	50391	U002	27.00 x	36.00 x	— x	6.00 x	5.50
8126	V	26.00 x	40.00 x	— x	7.00 x	—	51232	U002	27.00 x	36.00 x	— x	6.00 x	—
50482	U037	26.00 x	40.00 x	— x	8.00 x	7.00	52449	U001	27.00 x	36.00 x	— x	7.00 x	—
55000	U002	26.00 x	40.00 x	— x	9.00 x	—	51232	U002	27.00 x	36.00 x	— x	7.00 x	—
3129	C	26.00 x	40.00 x	4.50 x	10.00 x	—	52460	U031	27.00 x	36.00 x	— x	7.00 x	—
6081	CH	26.00 x	40.00 x	— x	24.00 x	—	51544	U001	27.00 x	36.50 x	— x	6.50 x	—
55001	U001	26.00 x	42.00 x	— x	8.00 x	—	55031	U001	27.00 x	37.00 x	— x	6.00 x	—
55002	U002	26.00 x	42.00 x	— x	8.00 x	—	50174	U004	27.00 x	37.00 x	— x	10.80 x	—
55003	U001	26.00 x	42.00 x	— x	9.00 x	—	55032	U002	27.00 x	38.00 x	— x	5.00 x	—
—	CH	26.00 x	42.00 x	— x	38.00 x	—	55567	U031	27.00 x	38.00 x	— x	8.00 x	—
52302	U020	26.00 x	43.00 x	— x	8.40 x	—	50091	U052	27.00 x	38.00 x	— x	8.00 x	—
55004	U001	26.00 x	43.00 x	— x	10.00 x	—	55033	U007	27.00 x	39.00 x	— x	9.50 x	—
55005	U002	26.00 x	43.00 x	— x	10.00 x	—	55034	U002	27.00 x	39.50 x	— x	6.00 x	—
6431	CH	26.00 x	43.00 x	— x	30.00 x	—	53362	U004	27.00 x	40.00 x	— x	5.00 x	—
8194	V	26.00 x	44.50 x	— x	7.50 x	—	52436	U	27.00 x	40.00 x	— x	6.50 x	—
55006	U002	26.00 x	44.50 x	— x	10.00 x	—	52436	U002	27.00 x	40.00 x	— x	6.50 x	—
55007	U001	26.00 x	45.00 x	— x	10.00 x	—	52196	U021	27.00 x	40.00 x	— x	6.50 x	—
55008	U002	26.00 x	45.00 x	— x	10.00 x	—	51553	U	27.00 x	40.00 x	— x	7.00 x	—
55009	U001	26.00 x	46.00 x	— x	10.00 x	—	50159	U067	27.00 x	40.00 x	— x	8.60 x	—
55010	U002	26.00 x	46.00 x	— x	10.00 x	—	53348	U004	27.00 x	40.00 x	— x	10.00 x	—
55011	U019	26.00 x	46.00 x	— x	10.00 x	—	52851	U	27.00 x	40.50 x	— x	6.00 x	—
55012	U001	26.00 x	47.00 x	— x	12.00 x	—	55034	U008	27.00 x	40.50 x	— x	6.00 x	—
55013	U002	26.00 x	47.00 x	— x	12.00 x	—	51783	U031	27.00 x	41.00 x	— x	5.40 x	—
55014	U001	26.00 x	50.00 x	— x	12.00 x	—	8401	V	27.00 x	41.00 x	— x	8.00 x	—
55015	U002	26.00 x	50.00 x	— x	12.00 x	—	55035	U001	27.00 x	43.00 x	— x	8.00 x	—
3458	C	26.00 x	51.00 x	4.00 x	9.00 x	—	55036	U002	27.00 x	43.00 x	— x	8.00 x	—





Cód	Mod	Di x	De x	Esp. x	Ha1 x	Ha2	Cód	Mod	Di x	De x	Esp. x	Ha1 x	Ha2
52866	U	27.00 x	43.00 x	— x	8.70 x	—	52920	U	28.00 x	38.00 x	— x	8.00 x	—
52866	U013	27.00 x	43.00 x	— x	8.70 x	—	59261	U001	28.00 x	38.00 x	— x	8.00 x	—
52677	U004	27.00 x	43.00 x	— x	9.00 x	—	55063	U002	28.00 x	38.00 x	— x	8.00 x	—
—	CH	27.00 x	43.00 x	— x	38.00 x	—	55064	U004	28.00 x	38.00 x	— x	8.00 x	—
52544	U042	27.00 x	44.00 x	— x	10.00 x	—	—	U04A	28.00 x	38.00 x	— x	9.52 x	—
—	CH	27.00 x	44.00 x	— x	37.00 x	—	55065	U004	28.00 x	38.00 x	— x	10.00 x	—
55037	U001	27.00 x	45.00 x	— x	10.00 x	—	53303	U031	28.00 x	38.00 x	— x	10.00 x	—
55038	U002	27.00 x	45.00 x	— x	10.00 x	—	55066	U001	28.00 x	38.00 x	— x	20.00 x	—
3183	C	27.00 x	45.00 x	— x	12.50 x	—	55067	U002	28.00 x	38.00 x	— x	20.00 x	—
55039	U001	27.00 x	46.00 x	— x	10.00 x	—	53525	UL	28.00 x	38.50 x	— x	7.50 x	—
55040	U002	27.00 x	46.00 x	— x	10.00 x	—	53211	U04A	28.00 x	39.00 x	— x	7.00 x	—
3311	C	27.00 x	46.00 x	5.50 x	11.00 x	—	55068	U005	28.00 x	39.00 x	— x	8.00 x	—
51545	U	27.00 x	47.00 x	— x	7.00 x	—	55069	U006	28.00 x	39.00 x	— x	8.00 x	—
55041	U001	27.00 x	47.00 x	— x	10.00 x	—	8002	V	28.00 x	40.00 x	— x	4.50 x	—
55042	U002	27.00 x	47.00 x	— x	10.00 x	—	55070	U001	28.00 x	40.00 x	— x	5.00 x	—
55043	U001	27.00 x	50.00 x	— x	12.00 x	—	55071	U002	28.00 x	40.00 x	— x	5.00 x	—
55044	U002	27.00 x	50.00 x	— x	12.00 x	—	50795	U002	28.00 x	40.00 x	— x	6.35 x	—
55045	U001	27.00 x	51.00 x	— x	8.00 x	—	52714	U04A	28.00 x	40.00 x	— x	6.35 x	—
55046	U001	27.00 x	55.00 x	— x	15.00 x	—	52714	U04A	28.00 x	40.00 x	— x	6.35 x	—
55047	U002	27.00 x	55.00 x	— x	15.00 x	—	F4112	W	28.00 x	40.00 x	— x	6.50 x	5.50
55048	U002	27.50 x	34.00 x	— x	7.00 x	—	8172	V	28.00 x	40.00 x	— x	7.50 x	—
55049	U007	27.50 x	36.00 x	— x	6.00 x	—	51766	U	28.00 x	40.00 x	— x	8.50 x	—
55549	U008	27.50 x	36.50 x	— x	4.20 x	6.00	51408	U	28.00 x	40.00 x	— x	9.00 x	—
55050	U005	27.50 x	38.00 x	— x	6.00 x	—	50240	U031	28.00 x	40.00 x	— x	9.00 x	—
55051	U002	27.50 x	40.00 x	— x	6.00 x	—	55072	U004	28.00 x	40.00 x	— x	10.00 x	—
52196	U021	27.50 x	40.00 x	— x	7.80 x	8.80	51911	U002	28.00 x	40.00 x	— x	11.00 x	—
52196	U021	27.50 x	40.00 x	— x	7.80 x	8.80	6132	CH	28.00 x	40.00 x	— x	11.00 x	—
55052	U001	27.50 x	40.00 x	— x	8.00 x	—	51994	U	28.00 x	40.00 x	— x	17.00 x	—
55053	U002	27.50 x	40.00 x	— x	10.00 x	—	6128	CH	28.00 x	40.00 x	— x	22.50 x	—
6424	CH	27.50 x	40.00 x	— x	30.00 x	—	6128	CH	28.00 x	40.00 x	— x	25.00 x	—
55054	U001	27.50 x	42.00 x	— x	8.50 x	—	52663	U004	28.00 x	40.50 x	— x	6.40 x	—
52766	U026	27.50 x	42.50 x	— x	8.70 x	—	52663	U004	28.00 x	40.50 x	— x	6.40 x	—
52766	U026	27.50 x	42.50 x	— x	8.70 x	—	8003	V	28.00 x	40.90 x	— x	7.00 x	—
55055	U001	27.50 x	46.00 x	— x	9.50 x	—	6064	CH	28.00 x	40.90 x	— x	26.50 x	—
52406	U003	27.50 x	66.00 x	— x	27.00 x	—	55073	U	28.00 x	43.00 x	— x	8.00 x	10.00
55056	U004	27.70 x	38.00 x	— x	8.00 x	—	53243	U	28.00 x	43.00 x	— x	10.00 x	—
55057	U001	27.78 x	40.38 x	— x	5.55 x	—	50364	U067	28.00 x	43.00 x	— x	10.00 x	8.00
55058	U002	27.78 x	40.38 x	— x	5.56 x	—	—	CH	28.00 x	43.00 x	— x	30.00 x	—
3250	C	28.00 x	31.50 x	2.70 x	9.00 x	—	55074	U002	28.00 x	43.50 x	— x	8.00 x	—
55059	U005	28.00 x	34.00 x	— x	4.90 x	—	55075	U001	28.00 x	44.00 x	— x	8.00 x	—
55060	U006	28.00 x	34.00 x	— x	4.90 x	—	55076	U002	28.00 x	44.00 x	— x	8.00 x	—
50087	U002	28.00 x	35.00 x	— x	3.50 x	—	51102	U026	28.00 x	44.00 x	— x	9.50 x	—
53066	U	28.00 x	35.00 x	— x	4.00 x	—	59230	U007	28.00 x	44.00 x	— x	11.00 x	—
50588	U031	28.00 x	35.00 x	— x	4.50 x	—	55077	U001	28.00 x	44.00 x	— x	12.00 x	—
52689	U031	28.00 x	35.00 x	— x	5.00 x	—	55078	U002	28.00 x	44.00 x	— x	12.00 x	—
51864	U004	28.00 x	35.20 x	— x	5.30 x	—	—	CH	28.00 x	44.00 x	— x	38.00 x	—
51816	U007	28.00 x	35.20 x	— x	5.30 x	—	55079	U003	28.00 x	44.50 x	— x	10.00 x	—
52071	U031	28.00 x	36.00 x	— x	4.00 x	—	55080	U003	28.00 x	44.50 x	— x	10.00 x	—
59294	UL	28.00 x	36.00 x	— x	5.00 x	6.50	6135	CH	28.00 x	45.00 x	— x	— x	—
51824	U	28.00 x	36.00 x	— x	5.50 x	—	F4130	W	28.00 x	45.00 x	— x	6.00 x	5.50
55061	U006	28.00 x	36.00 x	— x	5.50 x	—	55081	U001	28.00 x	45.00 x	— x	10.00 x	—
59295	U006	28.00 x	36.00 x	— x	5.70 x	—	55082	U002	28.00 x	45.00 x	— x	10.00 x	—
52933	U	28.00 x	36.00 x	— x	6.00 x	—	6135	CH	28.00 x	45.00 x	— x	30.00 x	—
59315	UL	28.00 x	36.00 x	4.00 x	6.00 x	8.00	55082	U001	28.00 x	46.00 x	— x	10.00 x	—
51999	U	28.00 x	36.00 x	— x	7.50 x	—	50038	U031	28.00 x	46.00 x	— x	10.00 x	—
53518	U	28.00 x	36.50 x	— x	4.80 x	6.00	55083	U002	28.00 x	47.00 x	— x	9.50 x	—
53536	UL	28.00 x	37.00 x	— x	4.50 x	6.00	55084	U001	28.00 x	48.00 x	— x	8.00 x	—
55062	U005	28.00 x	37.00 x	— x	6.00 x	—	55085	U002	28.00 x	48.00 x	— x	8.00 x	—
51971	U004	28.00 x	38.00 x	— x	5.00 x	—	55086	U001	28.00 x	48.00 x	— x	10.00 x	—
52929	U	28.00 x	38.00 x	— x	6.00 x	—	55087	U002	28.00 x	48.00 x	— x	10.00 x	—
52929	U	28.00 x	38.00 x	— x	6.00 x	—	55088	U019	28.00 x	48.00 x	— x	10.00 x	—
52978	U	28.00 x	38.00 x	— x	7.00 x	—	50885	U031	28.00 x	48.00 x	— x	11.00 x	—
52978	U005	28.00 x	38.00 x	— x	7.00 x	—	55089	U004	28.00 x	48.00 x	— x	12.00 x	—
52572	U056	28.00 x	38.00 x	— x	7.00 x	—	55090	U002	28.00 x	48.00 x	— x	15.00 x	—
59293	U005	28.00 x	38.00 x	— x	7.30 x	—	—	CH	28.00 x	48.00 x	— x	39.50 x	—
52694	U006	28.00 x	38.00 x	— x	7.50 x	6.50	50756	U002	28.00 x	50.00 x	— x	9.50 x	—
52920	U	28.00 x	38.00 x	— x	8.00 x	—	55091	U002	28.00 x	50.00 x	— x	10.00 x	—



Cód	Mod	Di x	De x	Esp. x	Ha1 x	Ha2	Cód	Mod	Di x	De x	Esp. x	Ha1 x	Ha2
55092	U001	28.00 x	50.00 x	— x	15.00 x	—	—	U04A	28.58 x	41.28 x	— x	9.52 x	—
55093	U002	28.00 x	50.00 x	— x	15.00 x	—	—	CH	28.58 x	41.28 x	— x	25.00 x	—
—	CH	28.00 x	50.00 x	— x	42.00 x	—	55122	U005	28.58 x	42.07 x	— x	9.92 x	—
55094	U001	28.00 x	52.00 x	— x	12.00 x	—	55123	U006	28.58 x	42.07 x	— x	9.92 x	—
55095	U002	28.00 x	52.00 x	— x	12.00 x	—	6007	CH	28.58 x	44.45 x	— x	20.64 x	—
55096	U001	28.00 x	55.00 x	— x	15.00 x	—	55124	U004	28.58 x	45.00 x	— x	11.00 x	—
55097	U002	28.00 x	55.00 x	— x	15.00 x	—	55125	U019	28.58 x	47.63 x	— x	9.53 x	—
55098	U001	28.00 x	60.00 x	— x	8.00 x	—	—	CH	28.58 x	47.63 x	— x	45.00 x	—
55099	U002	28.00 x	60.00 x	— x	8.00 x	—	—	CH	28.58 x	53.98 x	— x	39.00 x	—
3331	C	28.00 x	60.00 x	2.00 x	9.50 x	—	3262	C	28.58 x	82.55 x	3.97 x	12.70 x	—
55100	U002	28.00 x	60.00 x	— x	15.00 x	—	51445	U005	28.60 x	43.50 x	— x	9.00 x	—
55101	U001	28.00 x	65.00 x	— x	9.00 x	—	55126	U001	29.00 x	36.00 x	— x	6.00 x	—
55102	U002	28.00 x	65.00 x	— x	9.00 x	—	55127	U007	29.00 x	36.00 x	— x	6.00 x	—
55103	U001	28.00 x	70.00 x	— x	15.00 x	—	55128	U008	29.00 x	36.00 x	— x	6.40 x	—
55104	U001	28.00 x	70.00 x	— x	15.00 x	—	55129	U004	29.00 x	36.20 x	— x	4.00 x	—
55105	U002	28.00 x	70.00 x	— x	15.00 x	—	50680	U003	29.00 x	37.00 x	— x	2.60 x	—
55106	U001	28.00 x	73.50 x	— x	18.00 x	—	50680	U003	29.00 x	37.00 x	— x	2.60 x	—
55107	U002	28.00 x	73.50 x	— x	18.00 x	—	55130	U006	29.00 x	37.00 x	— x	5.50 x	—
3332	C	28.00 x	75.00 x	— x	15.00 x	—	50691	U008	29.00 x	37.00 x	— x	6.50 x	5.50
55108	U001	28.00 x	90.00 x	— x	13.00 x	—	55131	U001	29.00 x	38.00 x	— x	8.00 x	—
55109	U002	28.00 x	90.00 x	— x	13.00 x	—	55132	U002	29.00 x	38.00 x	— x	8.00 x	—
3102	C	28.00 x	125.30 x	4.00 x	16.50 x	—	59344	U04A	29.00 x	38.10 x	— x	8.10 x	—
55110	U006	28.18 x	36.12 x	— x	9.13 x	—	55133	U019	29.00 x	38.50 x	— x	5.00 x	—
55111	U005	28.20 x	36.20 x	— x	9.00 x	—	59360	UL	29.00 x	39.00 x	— x	5.00 x	7.00
8019	V	28.20 x	40.90 x	— x	7.10 x	—	59360	UL	29.00 x	39.00 x	— x	5.00 x	7.00
6080	CH	28.20 x	41.30 x	— x	22.00 x	—	55134	U008	29.00 x	39.00 x	— x	7.00 x	—
3421	C	28.20 x	50.80 x	3.20 x	12.00 x	—	51605	U006	29.00 x	40.00 x	— x	6.00 x	—
3447	C	28.30 x	54.50 x	2.80 x	12.00 x	—	F6841	W	29.00 x	40.00 x	— x	6.50 x	5.50
55112	U003	28.37 x	38.10 x	— x	4.76 x	—	50781	U003	29.00 x	40.00 x	— x	7.00 x	—
55113	U004	28.50 x	35.00 x	— x	5.00 x	—	55135	U002	29.00 x	40.00 x	— x	9.00 x	—
50164	U007	28.50 x	36.00 x	— x	6.60 x	—	52225	U002	29.00 x	40.80 x	— x	7.00 x	—
55114	U002	28.50 x	36.50 x	— x	3.00 x	—	51483	U	29.00 x	41.00 x	— x	6.25 x	—
55115	U019	28.50 x	37.00 x	— x	5.00 x	—	55136	U031	29.00 x	42.00 x	— x	6.20 x	—
53220	U	28.50 x	38.10 x	— x	7.94 x	—	3450	C	29.00 x	43.50 x	3.00 x	13.00 x	—
55116	U001	28.50 x	41.50 x	— x	6.20 x	—	3145	C	29.00 x	44.00 x	— x	8.00 x	—
55117	U002	28.50 x	41.50 x	— x	6.20 x	—	55137	U001	29.00 x	45.00 x	— x	8.00 x	—
51744	U030	28.50 x	44.40 x	— x	7.93 x	—	55138	U002	29.00 x	45.00 x	— x	8.00 x	—
6084	CH	28.50 x	50.00 x	— x	27.00 x	—	59451	U001	29.00 x	45.00 x	— x	8.20 x	—
3415	C	28.50 x	50.80 x	— x	12.70 x	—	55139	U007	29.00 x	45.00 x	— x	12.00 x	—
3300	C	28.50 x	82.50 x	3.12 x	12.70 x	—	55140	U008	29.00 x	45.00 x	— x	12.00 x	—
—	U04A	28.57 x	34.92 x	— x	6.35 x	—	—	CH	29.00 x	45.00 x	— x	38.00 x	—
55118	U	28.57 x	36.51 x	— x	5.56 x	6.35	55141	U002	29.00 x	46.00 x	— x	6.50 x	—
50399	U030	28.57 x	36.51 x	— x	6.35 x	5.56	55142	U001	29.00 x	50.00 x	— x	10.00 x	—
53297	U04A	28.57 x	38.10 x	— x	7.93 x	—	55143	U002	29.00 x	50.00 x	— x	10.00 x	—
53297	U04A	28.57 x	38.10 x	— x	7.93 x	—	—	CH	29.00 x	50.50 x	— x	40.00 x	—
53297	U04A	28.57 x	38.10 x	— x	7.93 x	—	3438	C	29.00 x	52.00 x	5.00 x	12.50 x	—
52452	U007	28.57 x	38.10 x	— x	12.70 x	11.11	3366	C	29.00 x	52.90 x	— x	12.30 x	—
8047	V	28.57 x	41.27 x	— x	4.50 x	—	55144	U001	29.00 x	55.00 x	— x	12.00 x	—
8159	V	28.57 x	41.27 x	— x	4.76 x	—	55145	U002	29.00 x	55.00 x	— x	12.00 x	—
8108	V	28.57 x	41.27 x	— x	6.35 x	—	55146	U001	29.00 x	56.00 x	— x	13.50 x	—
6116	CH	28.57 x	41.27 x	— x	14.29 x	—	55147	U002	29.00 x	56.00 x	— x	13.50 x	—
50104	U047	28.57 x	44.45 x	— x	10.32 x	—	53269	U001	29.30 x	38.10 x	— x	4.70 x	—
50104	U047	28.57 x	44.45 x	— x	10.32 x	—	53269	U001	29.30 x	38.10 x	— x	4.76 x	—
50836	U031	28.57 x	47.60 x	— x	9.50 x	—	53387	U003	29.37 x	38.10 x	— x	4.76 x	—
8034	V	28.57 x	50.80 x	— x	8.73 x	—	55148	U002	29.50 x	37.00 x	— x	3.50 x	—
55119	U001	28.57 x	50.80 x	— x	9.52 x	—	50476	U002	29.50 x	37.50 x	— x	4.00 x	—
50696	U001	28.57 x	53.97 x	— x	7.94 x	—	50266	U003	29.50 x	37.50 x	— x	4.00 x	—
3089	C	28.57 x	53.97 x	3.50 x	12.70 x	—	55149	U002	29.50 x	38.50 x	— x	11.00 x	—
52168	U	28.58 x	34.93 x	— x	3.17 x	—	55150	U008	29.50 x	39.50 x	— x	7.00 x	—
53052	U040	28.58 x	34.93 x	— x	3.17 x	—	50706	U031	29.50 x	39.50 x	— x	7.00 x	—
52846	U031	28.58 x	38.10 x	— x	4.76 x	—	55151	U004	29.50 x	40.00 x	— x	10.00 x	—
52846	U031	28.58 x	38.10 x	— x	4.76 x	—	53226	U005	29.50 x	41.00 x	— x	7.50 x	—
52048	U031	28.58 x	38.10 x	— x	6.35 x	—	53226	U005	29.50 x	41.00 x	— x	8.50 x	—
52888	U	28.58 x	41.28 x	— x	6.35 x	—	50591	U021	29.50 x	42.00 x	— x	9.50 x	—
52888	U001	28.58 x	41.28 x	— x	6.35 x	—	53454	U04A	29.50 x	42.00 x	— x	10.00 x	—
55120	U005	28.58 x	41.28 x	— x	7.94 x	—	8283	V	29.50 x	43.50 x	— x	4.50 x	—
55121	U006	28.58 x	41.28 x	— x	7.94 x	—	55152	U	29.50 x	44.50 x	— x	10.00 x	—



Cód	Mod	Di x	De x	Esp. x	Ha1 x	Ha2	Cód	Mod	Di x	De x	Esp. x	Ha1 x	Ha2
55153	U001	29.50 x	45.00 x	— x	7.50 x	—	52554	U	30.00 x	40.00 x	— x	7.00 x	—
55154	U003	29.50 x	47.50 x	— x	10.00 x	—	52437	U	30.00 x	40.00 x	— x	7.00 x	8.00
55155	U001	29.50 x	49.00 x	— x	9.00 x	—	50369	U002	30.00 x	40.00 x	— x	7.00 x	—
55156	U	29.50 x	49.50 x	— x	11.00 x	13.50	50369	U002	30.00 x	40.00 x	— x	7.00 x	—
50382	U063	29.50 x	49.50 x	— x	11.00 x	—	51119	U003	30.00 x	40.00 x	— x	7.00 x	—
3460	C	29.50 x	53.20 x	2.00 x	12.50 x	—	55180	U008	30.00 x	40.00 x	— x	7.00 x	—
6186	CH	29.93 x	42.00 x	— x	27.00 x	—	52868	U010	30.00 x	40.00 x	— x	7.00 x	—
6186	CH	29.93 x	42.00 x	— x	27.00 x	—	50882	U002	30.00 x	40.00 x	— x	7.50 x	—
55158	U003	30.00 x	37.00 x	— x	4.00 x	—	55181	U005	30.00 x	40.00 x	— x	7.50 x	—
55159	U002	30.00 x	37.00 x	— x	6.50 x	—	51533	U031	30.00 x	40.00 x	— x	7.50 x	—
55160	U001	30.00 x	37.00 x	— x	8.00 x	—	52184	U04A	30.00 x	40.00 x	— x	9.00 x	—
55161	U002	30.00 x	37.00 x	— x	8.00 x	—	52184	U04A	30.00 x	40.00 x	— x	9.00 x	—
55162	U031	30.00 x	37.50 x	— x	4.00 x	—	52512	U	30.00 x	40.00 x	— x	9.30 x	—
51509	U031	30.00 x	37.50 x	— x	5.00 x	—	52512	U002	30.00 x	40.00 x	— x	9.30 x	—
59316	UL	30.00 x	37.50 x	— x	5.00 x	7.50	55183	U004	30.00 x	40.00 x	— x	10.00 x	—
51840	U005	30.00 x	37.50 x	— x	6.50 x	—	55182	U005	30.00 x	40.00 x	— x	10.00 x	—
50398	U005	30.00 x	37.50 x	— x	7.00 x	—	55184	U007	30.00 x	40.00 x	— x	10.00 x	—
52826	U003	30.00 x	38.00 x	— x	4.00 x	—	55185	U008	30.00 x	40.00 x	— x	10.00 x	—
52535	U065	30.00 x	38.00 x	— x	4.00 x	—	51532	U031	30.00 x	40.00 x	— x	10.00 x	—
51138	U019	30.00 x	38.00 x	— x	4.50 x	—	55708	U04A	30.00 x	40.00 x	— x	10.00 x	—
51642	U005	30.00 x	38.00 x	— x	5.50 x	4.00	55186	U006	30.00 x	40.00 x	— x	10.30 x	—
8421	V	30.00 x	38.00 x	— x	5.50 x	—	55187	U006	30.00 x	40.00 x	— x	11.00 x	—
55645	U	30.00 x	38.00 x	— x	6.00 x	13.00	55188	U007	30.00 x	40.00 x	— x	12.00 x	—
51499	U002	30.00 x	38.00 x	— x	6.00 x	—	55189	U008	30.00 x	40.00 x	— x	12.00 x	—
55164	U002	30.00 x	38.00 x	— x	6.00 x	—	55190	U008	30.00 x	40.00 x	— x	12.00 x	—
55163	U055	30.00 x	38.00 x	— x	6.00 x	—	55191	U001	30.00 x	40.50 x	— x	9.00 x	—
55165	U007	30.00 x	38.00 x	— x	6.50 x	—	55192	U001	30.00 x	41.00 x	— x	5.50 x	—
52165	U	30.00 x	38.00 x	— x	8.00 x	—	59419	UL	30.00 x	41.00 x	— x	6.00 x	8.00
52931	U	30.00 x	38.00 x	— x	8.00 x	—	52233	U	30.00 x	41.00 x	— x	8.00 x	—
55166	U005	30.00 x	38.00 x	— x	8.00 x	—	52806	U005	30.00 x	41.30 x	— x	7.00 x	7.80
51065	U007	30.00 x	38.00 x	— x	8.00 x	6.35	52748	U001	30.00 x	42.00 x	— x	5.00 x	—
55167	U005	30.00 x	38.00 x	— x	12.00 x	—	59255	UL	30.00 x	42.00 x	— x	6.10 x	—
55168	U006	30.00 x	38.00 x	— x	12.00 x	—	59255	UL	30.00 x	42.00 x	— x	6.10 x	7.50
51264	U082	30.00 x	38.00 x	— x	15.00 x	12.50	52994	U	30.00 x	42.00 x	— x	9.50 x	—
55169	U007	30.00 x	38.10 x	— x	13.50 x	—	53273	U040	30.00 x	42.00 x	— x	9.50 x	—
55170	U008	30.00 x	38.10 x	— x	13.50 x	—	51956	U	30.00 x	42.00 x	— x	10.00 x	—
55171	U001	30.00 x	38.50 x	— x	5.00 x	—	55193	U004	30.00 x	42.00 x	— x	10.00 x	—
52440	U022	30.00 x	38.50 x	— x	6.20 x	5.40	55194	U005	30.00 x	42.00 x	— x	11.00 x	—
55172	U	30.00 x	39.00 x	— x	5.00 x	6.00	55195	U006	30.00 x	42.00 x	— x	11.00 x	—
51306	U	30.00 x	39.00 x	— x	6.00 x	—	8296	V	30.00 x	42.00 x	— x	11.00 x	—
50277	U030	30.00 x	39.00 x	— x	6.00 x	5.00	55196	U001	30.00 x	42.00 x	— x	12.00 x	—
55173	U	30.00 x	39.00 x	— x	6.40 x	—	6335	CH	30.00 x	42.00 x	— x	18.00 x	—
52649	U	30.00 x	39.00 x	— x	7.00 x	—	6409	CH	30.00 x	42.00 x	— x	31.00 x	—
50044	U002	30.00 x	39.00 x	— x	7.00 x	—	6433	CH	30.00 x	42.20 x	— x	20.00 x	—
53318	U04A	30.00 x	39.00 x	— x	10.00 x	—	55197	U002	30.00 x	42.50 x	— x	7.00 x	—
55174	U007	30.00 x	39.00 x	— x	13.50 x	—	52669	U	30.00 x	42.50 x	— x	9.00 x	—
55175	U008	30.00 x	39.00 x	— x	13.50 x	—	53130	U002	30.00 x	43.00 x	— x	4.80 x	—
55176	U004	30.00 x	39.40 x	— x	10.00 x	—	8388	V	30.00 x	43.00 x	— x	6.00 x	—
55667	UL	30.00 x	39.50 x	— x	6.50 x	8.50	51154	U	30.00 x	43.00 x	— x	6.80 x	—
55605	U	30.00 x	40.00 x	— x	3.00 x	6.00	51430	U004	30.00 x	43.00 x	— x	8.00 x	—
50066	U031	30.00 x	40.00 x	— x	4.00 x	—	52210	U008	30.00 x	43.00 x	— x	8.00 x	7.50
51395	U	30.00 x	40.00 x	— x	5.00 x	7.00	6164	CH	30.00 x	43.00 x	— x	21.50 x	—
55178	U001	30.00 x	40.00 x	— x	5.00 x	—	52674	U001	30.00 x	44.00 x	— x	6.30 x	—
55177	U002	30.00 x	40.00 x	— x	5.00 x	—	52674	U001	30.00 x	44.00 x	— x	6.30 x	—
51828	U065	30.00 x	40.00 x	— x	5.00 x	—	55755	U	30.00 x	44.00 x	— x	9.20 x	—
55546	UL	30.00 x	40.00 x	— x	5.00 x	8.00	50379	U002	30.00 x	44.00 x	— x	10.00 x	—
55546	UL	30.00 x	40.00 x	— x	5.00 x	8.00	8390	V	30.00 x	44.00 x	— x	10.00 x	—
52530	U002	30.00 x	40.00 x	— x	6.00 x	—	6165	CH	30.00 x	44.00 x	— x	20.00 x	—
50942	U002	30.00 x	40.00 x	— x	6.00 x	—	6192	CH	30.00 x	44.00 x	— x	20.00 x	—
50942	U002	30.00 x	40.00 x	— x	6.00 x	—	51071	U002	30.00 x	44.50 x	— x	10.00 x	—
51008	U003	30.00 x	40.00 x	— x	6.00 x	—	51071	U002	30.00 x	44.50 x	— x	10.00 x	—
50942	U004	30.00 x	40.00 x	— x	6.00 x	—	—	CH	30.00 x	44.50 x	— x	35.50 x	—
55179	U005	30.00 x	40.00 x	— x	6.00 x	—	8148	V	30.00 x	45.00 x	— x	6.00 x	—
51467	U008	30.00 x	40.00 x	— x	6.00 x	7.00	8354	V	30.00 x	45.00 x	— x	6.50 x	—
59303	UL	30.00 x	40.00 x	— x	6.00 x	8.30	8354	V	30.00 x	45.00 x	— x	6.50 x	—
59303	UL	30.00 x	40.00 x	— x	6.00 x	8.30	55198	U002	30.00 x	45.00 x	— x	7.50 x	—
51277	U	30.00 x	40.00 x	— x	7.00 x	—	50710	U006	30.00 x	45.00 x	— x	7.50 x	—



Cód	Mod	Di x	De x	Esp. x	Ha1 x	Ha2	Cód	Mod	Di x	De x	Esp. x	Ha1 x	Ha2
53166	U040	30.00 x	45.00 x	— x	7.50 x	—	55230	U002	30.00 x	70.00 x	— x	17.00 x	—
50845	U004	30.00 x	45.00 x	— x	8.00 x	10.00	3519	C	30.00 x	94.20 x	— x	12.50 x	—
F260	J	30.00 x	45.00 x	— x	10.00 x	13.00	3055	C	30.00 x	95.00 x	3.00 x	16.00 x	—
50993	U	30.00 x	45.00 x	— x	10.00 x	—	3363	C	30.00 x	120.00 x	— x	16.00 x	—
55199	U001	30.00 x	45.00 x	— x	10.00 x	—	3287	C	30.00 x	140.80 x	— x	19.50 x	—
55201	U002	30.00 x	45.00 x	— x	10.00 x	—	3510	C	30.00 x	253.00 x	— x	31.00 x	—
50993	U004	30.00 x	45.00 x	— x	10.00 x	—	59404	UL	30.16 x	36.69 x	— x	6.00 x	8.00
51180	U019	30.00 x	45.00 x	— x	10.00 x	—	55231	U004	30.16 x	38.10 x	— x	3.97 x	—
55200	U019	30.00 x	45.00 x	— x	10.00 x	—	8359	V	30.16 x	38.10 x	— x	4.76 x	—
51433	U002	30.00 x	45.00 x	— x	11.00 x	—	50460	U001	30.16 x	38.10 x	— x	6.35 x	—
55202	U001	30.00 x	45.00 x	— x	13.00 x	—	55232	U002	30.16 x	38.10 x	— x	6.35 x	—
55203	U002	30.00 x	45.00 x	— x	13.00 x	—	55234	U008	30.16 x	38.10 x	— x	6.35 x	—
6070	CH	30.00 x	45.00 x	— x	30.00 x	—	8367	V	30.16 x	38.10 x	— x	6.35 x	—
6234	CH	30.00 x	45.00 x	— x	38.50 x	—	55235	U007	30.16 x	38.10 x	— x	6.50 x	—
8087	V	30.00 x	46.00 x	— x	6.50 x	—	55236	U006	30.16 x	38.10 x	— x	7.94 x	—
55204	U001	30.00 x	46.00 x	— x	8.00 x	—	—	U04A	30.16 x	39.69 x	— x	4.76 x	—
55205	U002	30.00 x	46.00 x	— x	8.00 x	—	52932	U	30.16 x	39.69 x	— x	7.90 x	—
55206	U019	30.00 x	46.00 x	— x	8.00 x	—	52932	U	30.16 x	39.69 x	— x	7.90 x	—
53384	U04A	30.00 x	46.00 x	— x	9.00 x	—	6153	CH	30.16 x	39.69 x	— x	30.16 x	—
55207	U004	30.00 x	46.00 x	— x	10.00 x	—	51033	U	30.16 x	42.86 x	— x	9.52 x	—
8220	V	30.00 x	46.00 x	— x	10.00 x	—	—	U04A	30.16 x	46.04 x	— x	7.93 x	—
6268	CH	30.00 x	46.00 x	— x	19.00 x	—	59332	U	30.16 x	46.04 x	— x	7.95 x	—
6268	CH	30.00 x	46.00 x	— x	19.00 x	—	8318	V	30.16 x	47.63 x	— x	6.75 x	—
—	CH	30.00 x	46.00 x	— x	48.00 x	—	55237	U019	30.16 x	49.21 x	— x	9.53 x	—
51124	U	30.00 x	47.00 x	— x	12.00 x	9.50	50409	U019	30.16 x	49.21 x	— x	10.50 x	—
55208	U001	30.00 x	48.00 x	— x	9.00 x	—	55238	U004	30.16 x	49.61 x	— x	7.94 x	—
55209	U002	30.00 x	48.00 x	— x	9.00 x	—	55240	U002	30.16 x	50.40 x	— x	9.53 x	—
52200	U026	30.00 x	48.00 x	— x	13.00 x	—	8066	V	30.16 x	50.80 x	— x	8.73 x	—
51416	U	30.00 x	49.00 x	— x	9.00 x	—	8066	V	30.16 x	50.80 x	— x	8.73 x	—
55210	U002	30.00 x	49.00 x	— x	10.00 x	—	53112	U003	30.20 x	41.80 x	— x	10.00 x	—
55555	U005	30.00 x	49.00 x	— x	20.00 x	—	8033	V	30.20 x	48.00 x	— x	5.00 x	—
3029	C	30.00 x	50.00 x	2.00 x	7.00 x	—	50272	U002	30.20 x	50.80 x	— x	10.00 x	—
50907	U002	30.00 x	50.00 x	— x	8.00 x	—	55241	U005	30.50 x	38.00 x	— x	8.10 x	—
53223	U001	30.00 x	50.00 x	— x	10.00 x	—	55721	U	30.50 x	41.50 x	— x	9.50 x	—
50102	U002	30.00 x	50.00 x	— x	10.00 x	—	F9904	J	30.50 x	42.00 x	— x	9.00 x	7.80
51426	U006	30.00 x	50.00 x	— x	10.00 x	—	55640	U007	30.50 x	43.30 x	— x	8.00 x	9.50
55211	U019	30.00 x	50.00 x	— x	10.00 x	—	—	CH	30.50 x	43.50 x	— x	27.00 x	—
55212	U004	30.00 x	50.00 x	— x	11.00 x	—	3289	C	30.50 x	50.80 x	— x	10.00 x	—
3462	C	30.00 x	50.00 x	— x	12.00 x	—	3345	C	30.70 x	102.00 x	— x	19.00 x	—
50784	U	30.00 x	50.00 x	— x	12.00 x	—	50610	U004	30.80 x	50.80 x	— x	10.00 x	—
51077	U	30.00 x	50.00 x	— x	12.00 x	—	51287	U031	31.00 x	37.00 x	— x	3.60 x	3.20
—	CH	30.00 x	50.00 x	— x	25.00 x	—	51265	U	31.00 x	37.40 x	— x	4.00 x	—
—	CH	30.00 x	50.00 x	— x	56.00 x	—	55242	U007	31.00 x	37.50 x	— x	6.50 x	—
3029	C	30.00 x	50.00 x	— x	70.00 x	—	50220	U002	31.00 x	38.00 x	— x	4.00 x	—
55213	U004	30.00 x	50.50 x	— x	11.00 x	—	55243	U001	31.00 x	38.00 x	— x	9.50 x	—
50578	U002	30.00 x	51.00 x	— x	9.00 x	—	50921	U	31.00 x	39.00 x	— x	4.00 x	—
55214	U001	30.00 x	51.00 x	— x	10.00 x	—	52457	U032	31.00 x	39.00 x	— x	4.00 x	—
—	CH	30.00 x	51.00 x	— x	73.00 x	—	52273	U	31.00 x	39.00 x	— x	5.00 x	—
3215	C001	30.00 x	52.00 x	2.50 x	10.00 x	—	55244	U031	31.00 x	39.00 x	— x	5.00 x	—
55215	U002	30.00 x	52.00 x	— x	10.00 x	—	55245	U001	31.00 x	39.70 x	— x	6.00 x	—
55216	U001	30.00 x	52.00 x	— x	11.00 x	—	55246	U002	31.00 x	39.70 x	— x	6.00 x	—
55217	U002	30.00 x	52.00 x	— x	11.00 x	—	51122	U04A	31.00 x	40.00 x	— x	4.50 x	—
55218	U001	30.00 x	54.00 x	— x	12.50 x	—	51122	U04A	31.00 x	40.00 x	— x	4.50 x	—
55219	U002	30.00 x	54.00 x	— x	12.50 x	—	59401	UL	31.00 x	41.00 x	— x	5.00 x	7.00
3161	C	30.00 x	54.00 x	3.00 x	14.00 x	—	52069	U	31.00 x	41.00 x	— x	8.00 x	—
55220	U002	30.00 x	55.00 x	— x	12.00 x	—	55247	U002	31.00 x	41.00 x	— x	8.00 x	—
55221	U001	30.00 x	55.00 x	— x	12.50 x	—	55249	U008	31.00 x	42.00 x	— x	8.00 x	—
55222	U001	30.00 x	55.00 x	— x	15.00 x	—	55250	U002	31.00 x	43.00 x	— x	7.50 x	—
55223	U002	30.00 x	55.00 x	— x	15.00 x	—	52113	U	31.00 x	43.70 x	— x	6.35 x	—
—	CH	30.00 x	56.00 x	— x	44.00 x	—	51890	U026	31.00 x	44.50 x	— x	7.00 x	—
3174	C	30.00 x	60.00 x	3.00 x	12.00 x	—	55251	U002	31.00 x	45.00 x	— x	12.00 x	—
55224	U001	30.00 x	60.00 x	— x	15.00 x	—	55252	U005	31.00 x	45.00 x	— x	12.00 x	—
55225	U002	30.00 x	60.00 x	— x	15.00 x	—	55253	U008	31.00 x	46.00 x	— x	11.50 x	—
55226	U019	30.00 x	60.00 x	— x	15.00 x	—	52434	U	31.00 x	47.00 x	— x	12.00 x	—
55227	U001	30.00 x	62.00 x	— x	10.00 x	—	52504	U001	31.00 x	47.00 x	— x	12.00 x	—
55228	U002	30.00 x	62.00 x	— x	10.00 x	—	55254	U003	31.00 x	47.00 x	— x	12.00 x	—
55229	U001	30.00 x	70.00 x	— x	17.00 x	—	50821	U046	31.00 x	47.00 x	— x	12.00 x	—





Cód	Mod	Di x	De x	Esp. x	Ha1 x	Ha2	Cód	Mod	Di x	De x	Esp. x	Ha1 x	Ha2
52434	U046	31.00 x	47.00 x	— x	12.00 x	—	55274	U006	31.75 x	44.45 x	— x	6.35 x	—
—	CH	31.00 x	47.00 x	— x	38.00 x	—	55593	U04A	31.75 x	44.45 x	— x	7.14 x	—
59284	U002	31.00 x	48.00 x	— x	8.00 x	—	3067	C	31.75 x	44.45 x	3.17 x	7.94 x	—
55256	U	31.00 x	48.00 x	— x	10.00 x	11.00	8380	V	31.75 x	44.45 x	— x	8.33 x	—
50543	U037	31.00 x	48.00 x	— x	11.00 x	10.00	53181	U04A	31.75 x	44.45 x	— x	9.52 x	—
55257	U001	31.00 x	50.00 x	— x	10.00 x	—	50206	U053	31.75 x	44.45 x	— x	9.52 x	—
55258	U002	31.00 x	50.00 x	— x	10.00 x	—	55275	U004	31.75 x	44.45 x	— x	9.92 x	—
3417	C	31.00 x	50.50 x	— x	11.00 x	—	3201	C001	31.75 x	44.45 x	— x	11.11 x	—
8072	V	31.00 x	51.00 x	— x	8.50 x	—	—	U04A	31.75 x	44.45 x	— x	12.70 x	—
3037	C	31.00 x	60.00 x	3.50 x	11.50 x	—	6026	CH	31.75 x	44.45 x	— x	19.52 x	—
55259	U002	31.00 x	60.00 x	— x	12.00 x	—	—	CH	31.75 x	44.45 x	— x	21.50 x	—
55260	U001	31.00 x	68.00 x	— x	12.00 x	—	—	CH	31.75 x	44.45 x	— x	25.00 x	—
55261	U002	31.00 x	68.00 x	— x	12.00 x	—	—	CH	31.75 x	44.45 x	— x	30.00 x	—
3057	C	31.00 x	114.50 x	7.00 x	11.50 x	—	—	CH	31.75 x	44.45 x	— x	43.00 x	—
59298	U04A	31.20 x	41.40 x	— x	5.80 x	—	—	CH	31.75 x	44.45 x	— x	49.00 x	—
50906	U031	31.30 x	40.00 x	— x	7.00 x	—	—	CH	31.75 x	45.80 x	— x	32.50 x	—
3218	C	31.40 x	41.40 x	2.50 x	7.90 x	—	6293	CH	31.75 x	46.00 x	— x	60.00 x	—
50905	U	31.50 x	38.00 x	— x	7.00 x	—	8051	V	31.75 x	46.04 x	— x	6.35 x	—
50905	U031	31.50 x	38.00 x	— x	7.00 x	—	6455	CH	31.75 x	46.50 x	— x	20.00 x	—
50837	U	31.50 x	40.00 x	— x	7.00 x	—	8116	V	31.75 x	47.62 x	— x	7.30 x	—
50837	U005	31.50 x	40.00 x	— x	7.00 x	—	8242	V	31.75 x	47.62 x	— x	7.93 x	—
55262	U031	31.50 x	40.00 x	— x	10.00 x	—	55276	U001	31.75 x	47.62 x	— x	8.33 x	—
55263	U002	31.50 x	40.50 x	— x	7.50 x	—	59333	U	31.75 x	47.63 x	— x	7.95 x	—
50316	U007	31.50 x	40.60 x	— x	7.00 x	—	55277	U002	31.75 x	47.63 x	— x	9.53 x	—
51793	U	31.50 x	41.00 x	— x	6.00 x	—	6037	CH	31.75 x	47.63 x	— x	28.58 x	—
51793	U	31.50 x	41.00 x	— x	6.00 x	—	—	CH	31.75 x	47.63 x	— x	36.00 x	—
55264	U004	31.50 x	41.50 x	— x	10.00 x	—	—	CH	31.75 x	47.63 x	— x	37.50 x	—
50950	U002	31.50 x	42.50 x	— x	5.50 x	4.30	52844	U04A	31.75 x	47.65 x	— x	7.93 x	—
55266	U002	31.50 x	44.00 x	— x	6.00 x	—	52844	U04A	31.75 x	47.65 x	— x	7.93 x	—
52272	U040	31.50 x	44.00 x	— x	9.00 x	—	55278	U002	31.75 x	49.21 x	— x	9.53 x	—
52272	U040	31.50 x	44.00 x	— x	9.00 x	—	F6914	W	31.75 x	50.80 x	— x	6.00 x	5.00
—	CH	31.50 x	44.45 x	— x	27.00 x	—	8059	V	31.75 x	50.80 x	— x	6.35 x	—
8203	V	31.50 x	44.70 x	— x	4.20 x	—	8155	V	31.75 x	50.80 x	— x	7.00 x	14.00
6169	CH	31.50 x	44.70 x	— x	16.80 x	—	8031	V	31.75 x	50.80 x	— x	7.80 x	—
52533	U002	31.50 x	45.00 x	— x	6.00 x	—	8030	V	31.75 x	50.80 x	— x	7.94 x	—
—	CH	31.50 x	47.50 x	— x	21.00 x	—	55280	U019	31.75 x	50.80 x	— x	9.53 x	—
55267	U002	31.50 x	51.00 x	— x	7.50 x	—	6321	CH	31.75 x	50.80 x	— x	36.50 x	—
50763	U001	31.60 x	44.40 x	— x	7.20 x	—	—	CH	31.75 x	50.80 x	— x	61.00 x	—
55268	U006	31.70 x	40.00 x	— x	10.00 x	—	52350	U026	31.75 x	51.00 x	— x	12.50 x	—
51741	U004	31.70 x	41.20 x	— x	7.90 x	—	—	CH	31.75 x	52.39 x	— x	35.00 x	—
51741	U004	31.70 x	41.20 x	— x	7.90 x	—	50462	U003	31.75 x	73.02 x	— x	13.49 x	—
55269	U004	31.70 x	42.00 x	— x	9.00 x	—	3016	C	31.75 x	76.20 x	4.00 x	15.00 x	—
51342	U031	31.70 x	46.20 x	— x	8.00 x	—	3422	C	31.75 x	82.55 x	— x	12.00 x	—
52081	U009	31.70 x	50.80 x	— x	10.50 x	—	3148	C	31.75 x	101.60 x	— x	11.91 x	—
8361	V	31.70 x	50.80 x	— x	11.10 x	—	8278	V	31.80 x	41.50 x	— x	3.60 x	—
52171	U031	31.75 x	34.93 x	— x	4.76 x	—	6280	CH	31.80 x	57.00 x	— x	30.00 x	—
51036	U003	31.75 x	38.10 x	— x	4.76 x	—	3456	C	31.80 x	84.00 x	4.50 x	13.50 x	—
6224	CH	31.75 x	38.10 x	— x	23.81 x	—	53524	U04A	32.00 x	38.00 x	4.00 x	—	—
53332	U004	31.75 x	39.69 x	— x	3.97 x	—	52849	U	32.00 x	39.00 x	— x	5.00 x	—
55270	U005	31.75 x	40.00 x	— x	10.00 x	—	50437	U092	32.00 x	39.00 x	— x	6.50 x	—
55271	U	31.75 x	41.27 x	— x	4.76 x	6.35	50734	U	32.00 x	40.00 x	— x	4.00 x	—
53449	U002	31.75 x	41.27 x	— x	4.76 x	—	55281	U003	32.00 x	40.00 x	— x	4.00 x	—
50562	U005	31.75 x	41.27 x	— x	6.35 x	4.76	55282	U001	32.00 x	40.00 x	— x	4.50 x	—
50552	U	31.75 x	41.27 x	— x	7.94 x	—	55283	U005	32.00 x	40.00 x	— x	5.00 x	—
51580	U04A	31.75 x	41.27 x	— x	7.94 x	—	55284	U006	32.00 x	40.00 x	— x	5.00 x	—
50552	U04A	31.75 x	41.27 x	— x	7.94 x	—	52482	U002	32.00 x	40.00 x	— x	6.00 x	—
51580	U04A	31.75 x	41.27 x	— x	7.94 x	—	53367	U005	32.00 x	40.00 x	— x	6.00 x	—
50552	U04A	31.75 x	41.27 x	— x	7.94 x	—	52482	U04A	32.00 x	40.00 x	— x	6.00 x	—
—	U04A	31.75 x	41.28 x	— x	9.52 x	—	55285	U001	32.00 x	40.00 x	— x	7.00 x	—
52012	U	31.75 x	43.00 x	— x	4.50 x	—	55286	U002	32.00 x	40.00 x	— x	7.00 x	—
8332	V	31.75 x	43.00 x	— x	4.50 x	—	52136	U	32.00 x	40.00 x	— x	7.50 x	—
55272	U005	31.75 x	44.00 x	— x	6.00 x	—	52136	U	32.00 x	40.00 x	— x	7.50 x	—
F15104	W	31.75 x	44.45 x	— x	4.30 x	—	50515	U002	32.00 x	40.00 x	— x	8.00 x	—
8086	V	31.75 x	44.45 x	— x	4.76 x	—	55288	U004	32.00 x	40.00 x	— x	8.00 x	—
51204	U	31.75 x	44.45 x	— x	6.35 x	—	55287	U005	32.00 x	40.00 x	— x	8.00 x	—
51204	U002	31.75 x	44.45 x	— x	6.35 x	—	55289	U006	32.00 x	40.00 x	— x	8.00 x	—
55273	U005	31.75 x	44.45 x	— x	6.35 x	—	51398	U019	32.00 x	40.00 x	— x	8.00 x	—



Cód	Mod	Di x	De x	Esp. x	Ha1 x	Ha2	Cód	Mod	Di x	De x	Esp. x	Ha1 x	Ha2
51257	U007	32.00 x	40.00 x	— x	9.70 x	8.50	55309	U002	32.00 x	52.00 x	— x	10.00 x	—
51777	U	32.00 x	40.00 x	— x	10.00 x	—	55310	U004	32.00 x	52.00 x	— x	10.00 x	—
53143	U	32.00 x	40.50 x	— x	10.00 x	—	55311	U019	32.00 x	52.00 x	— x	10.00 x	—
50053	U006	32.00 x	41.00 x	— x	5.00 x	7.00	50766	U031	32.00 x	52.00 x	— x	10.00 x	—
55290	U002	32.00 x	41.00 x	— x	7.00 x	—	50704	U007	32.00 x	52.00 x	— x	11.00 x	9.50
50053	U006	32.00 x	41.00 x	— x	7.00 x	5.00	6397	CH	32.00 x	52.00 x	— x	21.00 x	—
51603	U006	32.00 x	41.00 x	— x	7.00 x	—	—	CH	32.00 x	52.50 x	— x	71.00 x	—
53201	U	32.00 x	42.00 x	— x	6.80 x	—	55312	U001	32.00 x	56.00 x	— x	12.00 x	—
3018	C	32.00 x	42.00 x	4.00 x	7.00 x	—	55313	U002	32.00 x	56.00 x	— x	12.00 x	—
53221	U005	32.00 x	42.00 x	— x	7.00 x	—	55314	U001	32.00 x	57.00 x	— x	13.00 x	—
51369	U006	32.00 x	42.00 x	— x	7.00 x	—	55315	U002	32.00 x	57.00 x	— x	13.00 x	—
51369	U027	32.00 x	42.00 x	— x	7.00 x	—	8103	V	32.00 x	57.00 x	— x	14.20 x	—
51948	U003	32.00 x	42.00 x	— x	9.00 x	—	3371	C	32.00 x	57.00 x	4.00 x	17.00 x	—
—	U04A	32.00 x	42.00 x	— x	9.00 x	—	6014	CH	32.00 x	57.00 x	— x	48.00 x	—
52755	U002	32.00 x	42.00 x	— x	10.00 x	—	6261	CH	32.00 x	57.00 x	— x	80.00 x	—
52755	U002	32.00 x	42.00 x	— x	10.00 x	—	55316	U001	32.00 x	58.00 x	— x	12.00 x	—
55291	U003	32.00 x	42.00 x	— x	10.00 x	—	55317	U002	32.00 x	58.00 x	— x	12.00 x	—
55292	U004	32.00 x	42.00 x	— x	10.00 x	—	55318	U001	32.00 x	58.00 x	— x	13.00 x	—
50896	U044	32.00 x	42.00 x	— x	22.50 x	—	55319	U002	32.00 x	58.00 x	— x	13.00 x	—
3062	C	32.00 x	43.00 x	4.00 x	7.00 x	—	55320	U004	32.00 x	60.00 x	— x	13.00 x	—
55293	U003	32.00 x	43.00 x	— x	7.00 x	—	55321	U001	32.00 x	60.00 x	— x	15.00 x	—
51657	U054	32.00 x	44.00 x	— x	5.00 x	6.50	55322	U002	32.00 x	60.00 x	— x	15.00 x	—
55294	U001	32.00 x	44.00 x	— x	6.00 x	—	55323	U002	32.00 x	63.00 x	— x	12.00 x	—
55295	U006	32.00 x	44.00 x	— x	6.50 x	—	55324	U001	32.00 x	65.00 x	— x	15.00 x	—
51348	U	32.00 x	44.00 x	— x	7.00 x	—	55325	U001	32.00 x	68.00 x	— x	12.00 x	—
51860	U	32.00 x	44.00 x	— x	10.00 x	—	55326	U002	32.00 x	68.00 x	— x	12.00 x	—
55297	U001	32.00 x	44.00 x	— x	12.00 x	—	55327	U002	32.00 x	70.00 x	— x	15.00 x	—
55298	U002	32.00 x	44.00 x	— x	12.00 x	—	3168	C	32.00 x	76.40 x	2.80 x	13.00 x	—
6085	CH	32.00 x	44.00 x	— x	25.00 x	—	3467	C	32.00 x	82.00 x	3.50 x	13.00 x	—
F15104	W	32.00 x	44.50 x	— x	4.30 x	—	3196	C001	32.00 x	82.55 x	3.50 x	11.00 x	—
55299	U003	32.00 x	44.50 x	— x	6.00 x	—	3196	C001	32.00 x	82.55 x	— x	11.00 x	—
52746	U002	32.00 x	44.50 x	— x	7.00 x	—	3256	C	32.00 x	97.50 x	— x	12.50 x	—
52746	U002	32.00 x	44.50 x	— x	7.00 x	—	3195	C001	32.00 x	101.60 x	— x	11.00 x	—
55300	U002	32.00 x	44.50 x	— x	8.00 x	—	3195	C001	32.00 x	101.60 x	3.00 x	11.00 x	—
55301	U004	32.00 x	44.50 x	— x	8.00 x	—	55328	U001	32.00 x	110.00 x	— x	13.00 x	—
8160	V	32.00 x	45.00 x	— x	5.00 x	—	55329	U002	32.00 x	110.00 x	— x	13.00 x	—
8160	V	32.00 x	45.00 x	— x	5.00 x	—	50293	U002	32.20 x	44.20 x	— x	6.50 x	—
52464	U	32.00 x	45.00 x	— x	6.50 x	—	51651	U	32.20 x	44.50 x	— x	6.30 x	—
55302	U002	32.00 x	45.00 x	— x	6.50 x	—	53334	U031	32.30 x	41.50 x	— x	5.00 x	—
8041	V	32.00 x	45.00 x	— x	7.00 x	—	52186	U	32.40 x	38.50 x	— x	9.80 x	5.80
51308	U002	32.00 x	45.00 x	— x	8.00 x	—	50868	U007	32.50 x	39.50 x	— x	8.00 x	7.50
51308	U002	32.00 x	45.00 x	— x	8.00 x	—	3132	C	32.50 x	41.50 x	— x	8.50 x	—
55303	U002	32.00 x	45.00 x	— x	10.00 x	—	59235	U006	32.50 x	42.50 x	— x	7.20 x	6.40
50688	U006	32.00 x	45.00 x	— x	10.00 x	—	50083	U007	32.50 x	43.00 x	— x	8.00 x	—
3545	C	32.00 x	45.00 x	— x	11.00 x	—	F13609	W	32.50 x	44.00 x	— x	5.30 x	6.10
6118	CH	32.00 x	45.00 x	— x	16.00 x	—	F3741	W	32.50 x	44.00 x	— x	6.10 x	5.30
6362	CH	32.00 x	46.00 x	— x	40.00 x	—	50841	U031	32.50 x	44.50 x	— x	5.00 x	—
F7621	W	32.00 x	46.50 x	— x	5.50 x	4.53	55330	U001	32.80 x	53.00 x	— x	15.00 x	—
51519	U	32.00 x	46.50 x	— x	8.00 x	—	55331	U002	32.80 x	53.00 x	— x	15.00 x	—
52657	U019	32.00 x	47.50 x	— x	5.00 x	—	52561	U031	32.85 x	38.40 x	— x	3.90 x	—
F12130	W	32.00 x	47.50 x	— x	7.80 x	—	55332	U004	32.94 x	59.53 x	— x	5.16 x	—
6343	CH	32.00 x	47.50 x	— x	7.80 x	—	55333	U002	33.00 x	39.00 x	— x	3.00 x	—
53200	U04A	32.00 x	47.50 x	— x	13.00 x	—	55334	U002	33.00 x	40.00 x	— x	4.00 x	—
55304	U001	32.00 x	48.00 x	— x	8.00 x	—	51222	U	33.00 x	40.00 x	— x	6.50 x	3.50
55305	U002	32.00 x	48.00 x	— x	8.00 x	—	52936	U004	33.00 x	40.00 x	— x	8.00 x	—
50594	U003	32.00 x	48.00 x	— x	8.00 x	—	52936	U004	33.00 x	40.00 x	— x	8.00 x	—
51067	U002	32.00 x	48.00 x	— x	9.50 x	—	55335	U007	33.00 x	40.00 x	— x	8.00 x	—
51259	U002	32.00 x	48.00 x	— x	9.50 x	—	55336	U008	33.00 x	40.00 x	— x	8.00 x	—
—	CH	32.00 x	48.00 x	— x	38.00 x	—	55337	U019	33.00 x	42.00 x	— x	5.50 x	—
53482	U007	32.00 x	48.50 x	— x	6.50 x	8.00	55338	U001	33.00 x	43.00 x	— x	6.00 x	—
52560	U004	32.00 x	49.00 x	— x	12.00 x	—	55339	U002	33.00 x	43.00 x	— x	6.50 x	—
51849	U	32.00 x	50.00 x	— x	9.20 x	—	52821	U007	33.00 x	43.00 x	— x	7.50 x	6.50
55306	U001	32.00 x	50.00 x	— x	10.00 x	—	55340	U	33.00 x	43.50 x	— x	9.00 x	11.00
55307	U002	32.00 x	50.00 x	— x	10.00 x	—	50308	U057	33.00 x	43.50 x	— x	11.00 x	9.00
55308	U004	32.00 x	50.00 x	— x	12.00 x	—	50321	U004	33.00 x	44.00 x	— x	8.00 x	—
—	CH	32.00 x	51.00 x	— x	76.00 x	—	55341	U001	33.00 x	45.00 x	— x	6.00 x	—
51428	U001	32.00 x	52.00 x	— x	10.00 x	—	55342	U002	33.00 x	45.00 x	— x	6.00 x	—



Cód	Mod	Di x	De x	Esp. x	Ha1 x	Ha2	Cód	Mod	Di x	De x	Esp. x	Ha1 x	Ha2
55343	U005	33.00 x	45.00 x	— x	9.00 x	—	55375	U003	34.00 x	48.00 x	— x	7.00 x	—
55344	U008	33.00 x	45.00 x	— x	9.00 x	—	55376	U001	34.00 x	48.00 x	— x	12.00 x	—
55744	U046	33.00 x	45.00 x	— x	9.50 x	—	55377	U002	34.00 x	48.00 x	— x	12.00 x	—
55345	U004	33.00 x	45.00 x	— x	10.00 x	—	55378	U002	34.00 x	49.00 x	— x	7.50 x	—
3396	C	33.00 x	45.00 x	6.00 x	12.00 x	—	50698	U015	34.00 x	50.00 x	— x	4.40 x	—
55346	U002	33.00 x	46.00 x	— x	5.00 x	—	55380	U002	34.00 x	50.00 x	— x	8.00 x	—
55347	U019	33.00 x	46.00 x	— x	8.00 x	—	55381	U004	34.00 x	54.00 x	— x	13.00 x	—
53028	U008	33.00 x	48.00 x	— x	9.00 x	7.00	55382	U001	34.00 x	60.00 x	— x	12.00 x	—
52683	U030	33.00 x	49.00 x	— x	12.00 x	10.00	55383	U002	34.00 x	60.00 x	— x	12.00 x	—
—	CH	33.00 x	49.00 x	— x	38.00 x	—	55384	U001	34.00 x	62.00 x	— x	15.00 x	—
55348	U004	33.00 x	50.00 x	— x	10.00 x	—	55385	U002	34.00 x	62.00 x	— x	15.00 x	—
8316	V	33.00 x	51.00 x	— x	7.00 x	—	55386	U001	34.10 x	50.80 x	— x	11.50 x	—
53435	U04A	33.00 x	54.00 x	— x	8.00 x	—	55387	U002	34.13 x	50.80 x	— x	11.50 x	—
55349	U001	33.00 x	55.00 x	— x	10.00 x	—	51358	U003	34.20 x	72.50 x	— x	27.00 x	—
55350	U002	33.00 x	55.00 x	— x	10.00 x	—	55388	U001	34.50 x	40.00 x	— x	4.00 x	—
55351	U001	33.00 x	60.00 x	— x	10.00 x	—	55389	U002	34.50 x	40.00 x	— x	4.00 x	—
55352	U002	33.00 x	60.00 x	— x	10.00 x	—	50980	U	34.50 x	43.00 x	— x	4.00 x	—
55353	U001	33.00 x	60.00 x	— x	15.00 x	—	52046	U004	34.50 x	43.00 x	— x	4.50 x	—
55354	U002	33.00 x	60.00 x	— x	15.00 x	—	50697	U	34.50 x	43.00 x	— x	5.50 x	—
3527	C	33.00 x	63.00 x	— x	10.00 x	—	50697	U	34.50 x	43.00 x	— x	5.50 x	—
55355	U001	33.00 x	68.00 x	— x	12.00 x	—	51049	U002	34.50 x	44.20 x	— x	5.50 x	—
55356	U002	33.00 x	68.00 x	— x	12.00 x	—	51049	U026	34.50 x	44.20 x	— x	5.50 x	—
59266	U04A	33.10 x	42.50 x	— x	7.50 x	—	55390	U002	34.50 x	44.50 x	— x	4.50 x	—
50983	U093	33.20 x	44.00 x	— x	7.00 x	—	55391	U001	34.50 x	45.00 x	— x	10.00 x	—
52336	U004	33.30 x	39.70 x	— x	3.20 x	—	F1504	W	34.50 x	47.00 x	— x	4.70 x	3.50
52336	U004	33.30 x	39.70 x	— x	3.20 x	—	55392	U002	34.50 x	47.00 x	— x	6.00 x	—
6410	CH	33.30 x	52.40 x	— x	31.00 x	—	6094	CH	34.50 x	47.00 x	— x	10.00 x	—
53399	U04A	33.30 x	52.55 x	— x	10.00 x	—	55393	U007	34.50 x	49.50 x	— x	9.00 x	—
55357	U007	33.34 x	42.86 x	— x	7.14 x	—	51100	U003	34.50 x	50.00 x	— x	8.00 x	—
55358	U002	33.34 x	43.66 x	— x	8.33 x	—	51611	U	34.50 x	50.80 x	— x	8.00 x	—
—	CH	33.34 x	49.21 x	— x	48.00 x	—	6235	CH	34.50 x	51.00 x	— x	27.00 x	—
55359	U019	33.34 x	52.39 x	— x	9.53 x	—	—	CH	34.50 x	51.50 x	— x	29.00 x	—
6185	CH	33.35 x	52.25 x	— x	30.00 x	—	—	CH	34.50 x	53.50 x	— x	24.00 x	—
6185	CH	33.35 x	52.25 x	— x	30.00 x	—	50468	U023	34.50 x	55.30 x	— x	12.00 x	—
6181	CH	33.35 x	52.25 x	— x	38.00 x	—	51942	U004	34.50 x	57.00 x	— x	12.70 x	—
55360	U001	33.50 x	49.50 x	— x	10.00 x	—	55620	U026	34.70 x	41.00 x	— x	4.00 x	—
6450	CH	33.50 x	52.00 x	— x	22.00 x	—	52803	U004	34.70 x	47.40 x	— x	9.50 x	—
55361	U001	33.50 x	53.50 x	— x	10.00 x	—	53125	U002	34.70 x	53.50 x	— x	8.50 x	—
55362	U002	33.50 x	53.50 x	— x	10.00 x	—	53400	U04A	34.80 x	53.70 x	— x	10.00 x	—
53004	U	33.50 x	54.80 x	— x	7.20 x	—	52814	U031	34.90 x	44.45 x	— x	5.00 x	4.50
53004	U009	33.50 x	54.80 x	— x	7.20 x	—	52946	U	34.90 x	44.45 x	— x	5.45 x	—
52986	U004	33.50 x	60.00 x	— x	12.00 x	—	8308	V	34.90 x	49.20 x	— x	7.10 x	—
52986	U	33.50 x	60.00 x	— x	12.40 x	—	55394	U006	34.90 x	50.00 x	— x	10.00 x	—
55626	U	33.80 x	40.00 x	— x	4.80 x	—	51650	U002	34.90 x	50.80 x	— x	9.50 x	—
55363	U019	34.00 x	41.00 x	— x	5.50 x	—	59342	U04A	34.90 x	50.80 x	— x	12.70 x	—
51510	U031	34.00 x	41.00 x	— x	8.30 x	—	52678	U	34.90 x	53.97 x	— x	9.50 x	—
52655	U031	34.00 x	42.00 x	— x	4.20 x	—	52678	U029	34.90 x	53.97 x	— x	9.50 x	—
51711	U001	34.00 x	42.00 x	— x	5.00 x	—	8292	V	34.90 x	54.80 x	— x	7.10 x	—
55364	U002	34.00 x	42.00 x	— x	5.00 x	—	52347	U	34.92 x	41.27 x	— x	4.76 x	—
55365	U002	34.00 x	42.00 x	— x	7.00 x	—	52738	U031	34.92 x	41.27 x	— x	5.50 x	—
8260	V	34.00 x	42.00 x	— x	10.50 x	—	51810	U	34.92 x	42.86 x	— x	4.76 x	4.00
51005	U	34.00 x	43.50 x	— x	6.50 x	5.00	50929	U002	34.92 x	44.45 x	— x	4.76 x	—
50059	U031	34.00 x	43.50 x	— x	7.00 x	—	50929	U002	34.92 x	44.45 x	— x	4.76 x	—
59396	UL	34.00 x	44.00 x	— x	4.50 x	7.00	51940	U004	34.92 x	44.45 x	— x	4.76 x	—
59413	UL	34.00 x	44.00 x	— x	4.50 x	6.00	51940	U004	34.92 x	44.45 x	— x	4.76 x	—
55700	U	34.00 x	44.00 x	— x	5.30 x	—	51316	U031	34.92 x	44.45 x	— x	4.77 x	4.00
55366	U007	34.00 x	44.00 x	— x	12.00 x	—	51809	U	34.92 x	44.45 x	— x	6.35 x	—
55367	U008	34.00 x	44.00 x	— x	12.00 x	—	51809	UL	34.92 x	44.45 x	— x	6.35 x	—
55368	U001	34.00 x	45.00 x	— x	7.00 x	—	51809	UL	34.92 x	44.45 x	— x	6.35 x	—
55369	U002	34.00 x	45.00 x	— x	7.00 x	—	51341	U002	34.92 x	44.45 x	— x	7.90 x	—
55370	U003	34.00 x	45.00 x	— x	7.00 x	—	51341	U002	34.92 x	44.45 x	— x	7.90 x	—
55371	U04A	34.00 x	46.00 x	— x	8.00 x	—	52863	U	34.92 x	44.45 x	— x	7.93 x	—
52374	U	34.00 x	46.00 x	— x	10.00 x	—	52863	U04A	34.92 x	44.45 x	— x	7.93 x	—
55372	U007	34.00 x	46.00 x	— x	12.00 x	—	52863	U04A	34.92 x	44.45 x	— x	7.93 x	—
55374	U008	34.00 x	46.00 x	— x	12.00 x	—	50556	U056	34.92 x	47.62 x	— x	5.95 x	—
55373	U008	34.00 x	46.00 x	— x	12.00 x	—	51879	U003	34.92 x	47.62 x	— x	9.52 x	—
55689	U019	34.00 x	46.00 x	— x	12.00 x	—	51879	U003	34.92 x	47.62 x	— x	9.52 x	—



Cód	Mod	Di x	De x	Esp. x	Ha1 x	Ha2	Cód	Mod	Di x	De x	Esp. x	Ha1 x	Ha2
6161	CH	34.92 x	47.62 x	— x	19.05 x	—	51643	U004	35.00 x	43.00 x	— x	8.00 x	—
50870	U003	34.92 x	49.21 x	— x	7.14 x	—	55411	U005	35.00 x	43.00 x	— x	8.00 x	—
8114	V	34.92 x	50.80 x	— x	7.00 x	—	55412	U006	35.00 x	43.00 x	— x	8.00 x	—
51921	U005	34.92 x	50.80 x	— x	7.93 x	—	50045	U031	35.00 x	43.00 x	— x	8.00 x	—
51383	U	34.92 x	50.80 x	— x	7.94 x	—	55413	U005	35.00 x	43.00 x	— x	13.50 x	—
50430	U002	34.92 x	50.80 x	— x	8.50 x	—	55414	U006	35.00 x	43.00 x	— x	13.50 x	—
8111	V	34.92 x	53.97 x	— x	7.94 x	—	51256	U031	35.00 x	43.50 x	— x	4.00 x	—
51344	U	34.92 x	53.97 x	— x	9.52 x	—	55415	U031	35.00 x	43.50 x	— x	4.00 x	—
8062	V	34.92 x	53.97 x	— x	9.52 x	—	52553	U	35.00 x	43.50 x	— x	6.35 x	—
3105	C	34.92 x	60.32 x	4.00 x	11.91 x	—	52553	U031	35.00 x	43.50 x	— x	6.35 x	—
3032	C	34.92 x	76.20 x	4.76 x	15.87 x	—	55416	U002	35.00 x	44.00 x	— x	5.00 x	—
3005	C	34.92 x	95.25 x	5.00 x	14.29 x	—	59392	UL	35.00 x	44.00 x	— x	5.00 x	6.30
53042	U A1	34.93 x	41.28 x	— x	3.18 x	—	59392	UL	35.00 x	44.00 x	— x	5.00 x	6.30
53042	U04A	34.93 x	41.28 x	— x	3.18 x	—	59383	UL	35.00 x	44.00 x	— x	5.00 x	6.00
55395	U005	34.93 x	41.28 x	— x	6.35 x	—	59356	UL	35.00 x	44.00 x	— x	5.00 x	7.20
51565	U031	34.93 x	42.86 x	— x	5.56 x	—	59405	UL	35.00 x	44.00 x	— x	5.00 x	6.30
53412	U	34.93 x	44.45 x	— x	3.97 x	—	59383	UL	35.00 x	44.00 x	— x	5.00 x	6.00
53412	U	34.93 x	44.45 x	— x	3.97 x	—	51955	U	35.00 x	44.00 x	— x	6.00 x	—
52926	U	34.93 x	44.45 x	— x	4.76 x	—	52014	U	35.00 x	44.00 x	— x	6.30 x	—
52926	U002	34.93 x	44.45 x	— x	4.76 x	—	6308	CH	35.00 x	44.50 x	— x	35.00 x	—
52926	U002	34.93 x	44.45 x	— x	4.76 x	—	59363	UL	35.00 x	44.60 x	— x	5.00 x	7.00
55396	U005	34.93 x	44.45 x	— x	5.56 x	—	59363	UL	35.00 x	44.60 x	— x	5.00 x	7.00
52956	U009	34.93 x	44.45 x	— x	6.75 x	—	55417	U001	35.00 x	45.00 x	— x	4.00 x	—
52956	U009	34.93 x	44.45 x	— x	6.75 x	—	55418	U002	35.00 x	45.00 x	— x	4.00 x	—
53134	U04A	34.93 x	44.45 x	— x	7.93 x	—	8010	V	35.00 x	45.00 x	— x	4.00 x	—
F8466	W	34.93 x	44.45 x	— x	9.52 x	—	51987	U	35.00 x	45.00 x	— x	5.00 x	—
53106	U04A	34.93 x	47.63 x	— x	9.53 x	—	51865	U	35.00 x	45.00 x	— x	5.00 x	—
53106	U04A	34.93 x	47.63 x	— x	9.53 x	—	51987	U002	35.00 x	45.00 x	— x	5.00 x	—
55397	U002	34.93 x	47.63 x	— x	9.92 x	—	52666	U	35.00 x	45.00 x	— x	6.00 x	—
55398	U003	34.93 x	47.63 x	— x	9.92 x	—	55420	U002	35.00 x	45.00 x	— x	6.00 x	—
55399	U005	34.93 x	50.00 x	— x	10.00 x	—	52666	U008	35.00 x	45.00 x	— x	6.00 x	—
51383	U002	34.93 x	50.80 x	— x	7.94 x	—	50661	U010	35.00 x	45.00 x	— x	6.50 x	—
51383	U031	34.93 x	50.80 x	— x	7.94 x	—	51210	U	35.00 x	45.00 x	— x	7.00 x	—
55400	U031	34.93 x	50.80 x	— x	7.94 x	—	51210	U002	35.00 x	45.00 x	— x	7.00 x	5.00
—	U04A	34.93 x	50.80 x	— x	12.70 x	—	55421	U008	35.00 x	45.00 x	— x	7.00 x	—
6018	CH	34.93 x	50.80 x	— x	22.23 x	—	50434	U027	35.00 x	45.00 x	— x	7.50 x	—
8258	V	34.93 x	53.98 x	— x	7.14 x	—	55422	U001	35.00 x	45.00 x	— x	8.00 x	—
55401	U019	34.93 x	53.98 x	— x	9.53 x	—	50401	U002	35.00 x	45.00 x	— x	8.00 x	—
6031	CH	34.93 x	53.98 x	— x	20.64 x	—	50401	U031	35.00 x	45.00 x	— x	8.00 x	—
51685	U003	34.93 x	57.15 x	— x	8.31 x	—	51441	U007	35.00 x	45.00 x	— x	8.50 x	7.00
—	CH	34.93 x	69.85 x	— x	61.00 x	—	50751	U	35.00 x	45.00 x	— x	10.00 x	—
50823	U	35.00 x	40.00 x	— x	4.00 x	—	51493	U003	35.00 x	45.00 x	— x	10.00 x	—
50823	U031	35.00 x	40.00 x	— x	4.00 x	—	55423	U004	35.00 x	45.00 x	— x	10.00 x	—
52092	U	35.00 x	40.00 x	— x	10.00 x	—	51334	U006	35.00 x	45.00 x	— x	10.00 x	—
51156	U001	35.00 x	41.00 x	— x	3.20 x	—	52710	U04A	35.00 x	45.00 x	— x	10.00 x	—
55402	U005	35.00 x	41.50 x	— x	5.00 x	—	6306	CH	35.00 x	45.00 x	— x	25.00 x	—
55550	U	35.00 x	41.70 x	— x	3.20 x	—	55424	U001	35.00 x	46.00 x	— x	5.50 x	—
55403	U031	35.00 x	42.00 x	— x	4.00 x	—	55425	U001	35.00 x	46.00 x	— x	8.00 x	—
55404	U004	35.00 x	42.00 x	— x	4.50 x	—	55426	U002	35.00 x	46.00 x	— x	8.00 x	—
55405	U002	35.00 x	42.00 x	— x	8.00 x	—	—	CH	35.00 x	46.50 x	— x	33.50 x	—
55406	U008	35.00 x	42.00 x	— x	8.00 x	—	52177	U	35.00 x	47.00 x	— x	7.00 x	—
55407	U007	35.00 x	42.00 x	— x	10.00 x	—	52177	U04A	35.00 x	47.00 x	— x	7.00 x	—
55408	U008	35.00 x	42.00 x	— x	10.00 x	—	55691	U002	35.00 x	47.00 x	— x	8.00 x	—
50886	U003	35.00 x	42.50 x	— x	4.00 x	—	50185	U031	35.00 x	47.00 x	— x	12.00 x	—
50886	U003	35.00 x	42.50 x	— x	4.00 x	—	6228	CH	35.00 x	47.00 x	— x	23.00 x	—
50540	U004	35.00 x	42.50 x	— x	4.50 x	—	6228	CH	35.00 x	47.00 x	— x	23.00 x	—
51267	U004	35.00 x	42.80 x	— x	4.00 x	—	3003	C	35.00 x	47.20 x	3.00 x	8.70 x	—
51093	U004	35.00 x	43.00 x	— x	4.00 x	—	50032	U031	35.00 x	47.60 x	— x	6.50 x	—
51186	U047	35.00 x	43.00 x	— x	4.00 x	—	50260	U002	35.00 x	48.00 x	— x	3.50 x	—
52922	U04A	35.00 x	43.00 x	— x	4.60 x	—	55628	U006	35.00 x	48.00 x	— x	4.00 x	—
52509	U001	35.00 x	43.00 x	— x	5.00 x	—	55427	U004	35.00 x	48.00 x	— x	9.00 x	—
55409	U001	35.00 x	43.00 x	— x	5.00 x	—	50180	U031	35.00 x	48.00 x	— x	10.00 x	—
50118	U003	35.00 x	43.00 x	— x	5.00 x	—	55718	U003	35.00 x	49.50 x	— x	9.50 x	—
55410	U031	35.00 x	43.00 x	— x	5.00 x	—	8195	V	35.00 x	50.00 x	— x	6.50 x	—
53144	U	35.00 x	43.00 x	— x	5.30 x	—	8195	V	35.00 x	50.00 x	— x	6.50 x	—
51953	U	35.00 x	43.00 x	— x	5.50 x	—	55428	U002	35.00 x	50.00 x	— x	7.00 x	—
50626	U002	35.00 x	43.00 x	— x	8.00 x	—	59277	U04A	35.00 x	50.00 x	— x	7.00 x	—





Cód	Mod	Di x	De x	Esp. x	Ha1 x	Ha2	Cód	Mod	Di x	De x	Esp. x	Ha1 x	Ha2
50165	U019	35.00 x	50.00 x	— x	7.20 x	—	55453	U002	35.00 x	65.00 x	— x	20.00 x	—
50165	U056	35.00 x	50.00 x	— x	7.20 x	—	—	CH	35.00 x	65.00 x	— x	54.00 x	—
50035	U058	35.00 x	50.00 x	— x	7.20 x	—	6405	CH	35.00 x	69.00 x	— x	45.00 x	—
50050	U031	35.00 x	50.00 x	— x	7.50 x	—	55454	U001	35.00 x	70.00 x	— x	15.00 x	—
50943	U006	35.00 x	50.00 x	— x	8.00 x	7.00	55455	U002	35.00 x	70.00 x	— x	15.00 x	—
50568	U031	35.00 x	50.00 x	— x	8.00 x	—	55456	U001	35.00 x	70.50 x	— x	20.00 x	—
55586	U04A	35.00 x	50.00 x	— x	8.00 x	—	55457	U002	35.00 x	70.50 x	— x	20.00 x	—
51409	U04A	35.00 x	50.00 x	— x	8.00 x	—	51684	U	35.00 x	72.00 x	— x	12.00 x	—
50843	U	35.00 x	50.00 x	— x	9.00 x	—	—	CH	35.00 x	75.00 x	— x	64.00 x	—
50406	U004	35.00 x	50.00 x	— x	9.50 x	—	3126	C	35.00 x	81.70 x	— x	10.00 x	—
50889	U003	35.00 x	50.00 x	— x	10.00 x	—	55458	U001	35.00 x	90.00 x	— x	20.00 x	—
55429	U003	35.00 x	50.00 x	— x	10.00 x	—	55459	U002	35.00 x	90.00 x	— x	20.00 x	—
50410	U004	35.00 x	50.00 x	— x	10.00 x	—	3372	C	35.00 x	95.00 x	5.00 x	16.00 x	—
55430	U004	35.00 x	50.00 x	— x	10.00 x	—	3389	C	35.00 x	305.00 x	4.00 x	24.00 x	—
50684	U004	35.00 x	50.00 x	— x	10.00 x	—	3390	C	35.00 x	308.00 x	5.00 x	24.00 x	—
50684	U004	35.00 x	50.00 x	— x	10.00 x	—	55460	U005	35.20 x	43.20 x	— x	9.00 x	—
55431	U019	35.00 x	50.00 x	— x	10.00 x	—	55461	U006	35.20 x	43.20 x	— x	9.00 x	—
52143	U04A	35.00 x	50.00 x	— x	10.50 x	—	52424	U	35.20 x	45.20 x	— x	4.80 x	—
6243	CH	35.00 x	50.00 x	— x	20.00 x	—	6125	CH	35.20 x	47.40 x	— x	24.00 x	—
6143	CH	35.00 x	50.00 x	— x	22.50 x	—	50686	U	35.20 x	48.00 x	— x	10.00 x	—
52143	U04A	35.00 x	50.50 x	— x	10.50 x	—	51397	U	35.20 x	49.50 x	— x	8.00 x	—
F5181	W	35.00 x	51.00 x	— x	7.50 x	6.50	51397	U019	35.20 x	49.50 x	— x	8.00 x	—
55432	U001	35.00 x	51.00 x	— x	8.00 x	—	8029	V	35.20 x	49.80 x	— x	7.50 x	—
55433	U002	35.00 x	51.00 x	— x	8.00 x	—	50160	U031	35.30 x	42.00 x	— x	4.00 x	—
55434	U002	35.00 x	51.00 x	— x	9.50 x	—	50279	U002	35.30 x	50.80 x	— x	8.00 x	—
55435	U001	35.00 x	51.00 x	— x	13.00 x	—	59327	U04A	35.38 x	44.05 x	— x	7.95 x	—
55436	U001	35.00 x	51.00 x	— x	13.00 x	—	51893	U008	35.40 x	45.00 x	— x	7.00 x	—
55437	U002	35.00 x	51.00 x	— x	13.00 x	—	6310	CH	35.40 x	47.00 x	— x	23.00 x	—
—	CH	35.00 x	51.00 x	— x	38.00 x	—	55462	U004	35.50 x	44.50 x	— x	10.00 x	—
6183	CH	35.00 x	51.50 x	— x	22.00 x	—	55463	U001	35.50 x	48.00 x	— x	10.00 x	—
50786	U002	35.00 x	52.00 x	— x	4.50 x	—	55464	U002	35.50 x	48.00 x	— x	10.00 x	—
8182	V	35.00 x	52.00 x	— x	5.00 x	—	51381	U005	35.50 x	50.20 x	— x	8.00 x	—
55438	U001	35.00 x	52.00 x	— x	10.00 x	—	52253	U006	35.50 x	50.80 x	— x	7.50 x	—
50138	U002	35.00 x	52.00 x	— x	10.00 x	—	55465	U002	35.50 x	52.50 x	— x	9.00 x	—
55439	U004	35.00 x	52.00 x	— x	12.00 x	—	F6270	J	35.50 x	55.20 x	— x	12.50 x	20.00
52487	U	35.00 x	52.00 x	— x	12.20 x	—	50971	U005	35.70 x	66.00 x	— x	15.10 x	—
55440	U003	35.00 x	54.00 x	— x	10.00 x	—	55466	U002	35.80 x	42.00 x	— x	4.00 x	—
8070	V	35.00 x	54.00 x	— x	13.00 x	—	55467	U001	35.80 x	61.00 x	— x	12.00 x	—
8070	V	35.00 x	54.00 x	— x	13.00 x	—	55468	U002	35.80 x	61.00 x	— x	12.00 x	—
—	CH	35.00 x	54.00 x	— x	46.00 x	—	55469	U031	36.00 x	41.00 x	— x	6.50 x	—
8181	V	35.00 x	55.00 x	— x	7.50 x	—	55470	U001	36.00 x	42.00 x	— x	7.00 x	—
F4599	J	35.00 x	55.00 x	— x	8.70 x	11.00	55471	U002	36.00 x	42.00 x	— x	7.00 x	—
55441	U001	35.00 x	55.00 x	— x	10.00 x	—	55595	U04A	36.00 x	43.00 x	— x	6.50 x	—
51425	U001	35.00 x	55.00 x	— x	10.00 x	—	53067	UL	36.00 x	44.00 x	— x	5.50 x	8.00
50397	U002	35.00 x	55.00 x	— x	10.00 x	—	55472	U004	36.00 x	44.50 x	— x	6.00 x	—
50397	U002	35.00 x	55.00 x	— x	10.00 x	—	55473	U001	36.00 x	45.00 x	— x	4.50 x	—
55442	U019	35.00 x	55.00 x	— x	10.00 x	—	55474	U002	36.00 x	45.00 x	— x	4.50 x	—
51832	U004	35.00 x	55.00 x	— x	12.00 x	—	55558	U04A	36.00 x	45.00 x	— x	6.00 x	—
55443	U004	35.00 x	55.00 x	— x	12.00 x	—	52661	U001	36.00 x	46.00 x	— x	6.00 x	—
51832	U004	35.00 x	55.00 x	— x	12.00 x	—	55475	U002	36.00 x	46.00 x	— x	6.00 x	—
6395	CH	35.00 x	55.00 x	— x	23.00 x	—	52982	U	36.00 x	46.00 x	— x	7.00 x	—
55444	U001	35.00 x	56.00 x	— x	10.00 x	—	51280	U002	36.00 x	46.00 x	— x	7.00 x	—
55445	U002	35.00 x	56.00 x	— x	10.00 x	—	52982	U005	36.00 x	46.00 x	— x	7.00 x	—
55446	U003	35.00 x	56.00 x	— x	11.00 x	—	55683	U006	36.00 x	46.00 x	— x	7.00 x	—
50254	U059	35.00 x	58.00 x	— x	11.00 x	—	55476	U006	36.00 x	46.00 x	— x	7.00 x	—
50254	U059	35.00 x	58.00 x	— x	11.00 x	—	50742	U008	36.00 x	46.00 x	— x	7.00 x	5.00
3004	C	35.00 x	60.00 x	4.00 x	12.00 x	—	55737	U	36.00 x	46.00 x	— x	7.30 x	—
51892	U002	35.00 x	60.00 x	— x	12.00 x	—	50269	U061	36.00 x	46.00 x	— x	8.00 x	—
55447	U002	35.00 x	60.00 x	— x	12.00 x	—	51446	U004	36.00 x	46.00 x	— x	9.00 x	—
55448	U003	35.00 x	60.00 x	— x	12.00 x	—	55477	U002	36.00 x	46.00 x	— x	10.00 x	—
55449	U006	35.00 x	60.00 x	— x	12.00 x	—	52296	U027	36.00 x	46.00 x	— x	10.00 x	—
55450	U019	35.00 x	60.00 x	— x	12.00 x	—	52296	U027	36.00 x	46.00 x	— x	10.00 x	—
55451	U001	35.00 x	60.00 x	— x	20.00 x	—	59367	UL	36.00 x	47.00 x	— x	7.00 x	10.00
55452	U002	35.00 x	60.00 x	— x	20.00 x	—	59367	UL	36.00 x	47.00 x	— x	7.00 x	10.00
3192	C	35.00 x	63.50 x	3.00 x	11.50 x	—	55478	U001	36.00 x	47.00 x	— x	9.00 x	—
3106	C	35.00 x	64.00 x	5.00 x	12.00 x	—	55479	U002	36.00 x	47.00 x	— x	9.00 x	—
51781	U001	35.00 x	65.00 x	— x	20.00 x	—	55480	U003	36.00 x	47.50 x	— x	10.00 x	—



Cód	Mod	Di x	De x	Esp. x	Ha1 x	Ha2	Cód	Mod	Di x	De x	Esp. x	Ha1 x	Ha2
52201	U002	36.00 x	48.00 x	— x	6.00 x	—	55513	U002	37.00 x	49.00 x	— x	5.50 x	—
55481	U002	36.00 x	48.00 x	— x	6.00 x	—	55514	U001	37.00 x	52.00 x	— x	10.00 x	—
55482	U004	36.00 x	48.00 x	— x	10.00 x	—	55515	U004	37.00 x	52.00 x	— x	10.00 x	—
—	CH	36.00 x	48.00 x	— x	28.00 x	—	55516	U006	37.00 x	52.00 x	— x	10.00 x	—
55483	U001	36.00 x	50.00 x	— x	7.00 x	—	51357	U	37.00 x	53.00 x	— x	7.00 x	—
55484	U002	36.00 x	50.00 x	— x	7.00 x	—	—	CH	37.00 x	53.00 x	— x	38.00 x	—
F4123	W	36.00 x	50.00 x	— x	7.50 x	6.50	55517	U002	37.00 x	53.50 x	— x	8.00 x	—
—	U04A	36.00 x	50.00 x	— x	7.92 x	—	55518	U001	37.00 x	54.00 x	— x	14.50 x	—
55485	U04A	36.00 x	50.00 x	— x	8.00 x	—	55519	U002	37.00 x	55.00 x	— x	11.00 x	—
55486	U019	36.00 x	50.00 x	— x	10.00 x	—	50074	U001	37.00 x	55.00 x	— x	12.50 x	—
52122	U002	36.00 x	51.00 x	— x	5.00 x	—	55520	U001	37.00 x	57.00 x	— x	10.00 x	—
55624	U004	36.00 x	51.00 x	— x	8.00 x	—	55521	U002	37.00 x	57.00 x	— x	10.00 x	—
55624	U004	36.00 x	51.00 x	— x	8.00 x	—	—	CH	37.00 x	58.50 x	— x	42.00 x	—
55625	U006	36.00 x	51.00 x	— x	9.50 x	—	51529	U	37.00 x	60.00 x	— x	10.00 x	—
55625	U04A	36.00 x	51.00 x	— x	9.50 x	—	55522	U002	37.00 x	60.00 x	— x	10.00 x	—
—	CH	36.00 x	51.00 x	— x	27.50 x	—	52079	U009	37.00 x	63.50 x	— x	10.50 x	—
52179	U	36.00 x	52.00 x	— x	12.00 x	—	55523	U001	37.00 x	68.00 x	— x	12.00 x	—
6283	CH	36.00 x	52.00 x	— x	33.50 x	—	55524	U001	37.00 x	68.00 x	— x	12.00 x	—
55488	U001	36.00 x	55.00 x	— x	8.50 x	—	55525	U002	37.00 x	68.00 x	— x	12.00 x	—
55489	U002	36.00 x	55.00 x	— x	8.50 x	—	55526	U002	37.31 x	52.39 x	— x	8.73 x	—
51386	U001	36.00 x	55.00 x	— x	10.00 x	—	50273	U065	37.50 x	43.50 x	— x	3.20 x	—
55490	U002	36.00 x	55.00 x	— x	10.50 x	—	52813	U007	37.50 x	49.00 x	— x	5.50 x	6.00
55491	U004	36.00 x	55.00 x	— x	12.00 x	—	52813	U	37.50 x	49.00 x	— x	6.00 x	—
55492	U001	36.00 x	56.00 x	— x	10.00 x	—	52813	U007	37.50 x	49.00 x	— x	6.00 x	5.30
55493	U002	36.00 x	56.00 x	— x	10.00 x	—	53136	U002	37.50 x	50.80 x	— x	8.00 x	—
55494	U031	36.00 x	58.00 x	— x	12.00 x	—	53437	U058	37.50 x	52.00 x	— x	7.00 x	—
55495	U001	36.00 x	59.00 x	— x	12.00 x	—	—	CH	37.50 x	52.50 x	— x	40.50 x	—
55496	U002	36.00 x	59.00 x	— x	12.00 x	—	—	CH	37.50 x	54.00 x	— x	36.50 x	—
3221	C	36.00 x	60.00 x	5.00 x	10.00 x	—	55527	U007	37.70 x	50.00 x	— x	8.00 x	—
3323	C	36.00 x	60.00 x	— x	10.90 x	—	55528	U008	37.70 x	50.00 x	— x	8.00 x	—
55497	U001	36.00 x	60.00 x	— x	12.00 x	—	8377	V	37.70 x	58.50 x	— x	12.20 x	—
55498	U002	36.00 x	60.00 x	— x	12.00 x	—	52842	U04A	38.00 x	40.00 x	— x	6.50 x	—
52948	U	36.00 x	66.00 x	— x	15.00 x	—	51947	U008	38.00 x	42.00 x	— x	4.00 x	—
59229	U	36.00 x	66.00 x	— x	16.00 x	18.00	55529	U031	38.00 x	45.00 x	— x	4.00 x	—
55661	U009	36.00 x	68.20 x	— x	10.00 x	—	51148	U	38.00 x	45.00 x	— x	6.00 x	5.50
3185	C001	36.00 x	95.00 x	3.50 x	16.00 x	—	55530	U002	38.00 x	45.00 x	— x	6.00 x	—
55499	U001	36.50 x	45.00 x	— x	4.80 x	—	55531	U005	38.00 x	45.00 x	— x	6.00 x	—
55500	U002	36.50 x	45.00 x	— x	4.80 x	—	55532	U006	38.00 x	45.00 x	— x	6.00 x	—
55501	U004	36.50 x	46.00 x	— x	9.50 x	—	55533	U002	38.00 x	45.00 x	— x	6.50 x	—
52263	U	36.50 x	47.00 x	— x	9.50 x	—	55534	U001	38.00 x	45.00 x	— x	10.00 x	—
52951	U	36.50 x	50.80 x	— x	6.50 x	—	51508	U	38.00 x	46.00 x	— x	8.00 x	—
52951	U	36.50 x	50.80 x	— x	7.00 x	6.50	51508	U	38.00 x	46.00 x	— x	8.00 x	—
55502	U002	36.50 x	56.00 x	— x	10.50 x	—	55535	U005	38.00 x	46.00 x	— x	12.00 x	—
3104	C	36.50 x	101.60 x	— x	18.00 x	—	55536	U006	38.00 x	46.00 x	— x	12.00 x	—
53008	U	36.51 x	42.86 x	— x	3.18 x	—	55537	U002	38.00 x	46.50 x	— x	5.00 x	—
53008	U04A	36.51 x	42.86 x	— x	3.18 x	—	52957	U	38.00 x	47.00 x	— x	5.00 x	—
55503	U031	36.51 x	44.45 x	— x	3.97 x	—	50851	U	38.00 x	47.00 x	— x	5.00 x	—
55504	U007	36.51 x	44.45 x	— x	7.14 x	—	55538	U002	38.00 x	47.00 x	— x	12.00 x	—
50214	U002	36.51 x	50.80 x	— x	7.14 x	—	6423	CH	38.00 x	47.60 x	— x	32.50 x	—
—	U04A	36.51 x	52.39 x	— x	7.93 x	—	55539	U007	38.00 x	47.70 x	— x	12.00 x	—
53229	U04A	36.51 x	55.56 x	— x	9.53 x	—	55540	U008	38.00 x	47.70 x	— x	12.00 x	—
55505	U019	36.51 x	57.15 x	— x	7.94 x	—	52872	U	38.00 x	48.00 x	— x	6.00 x	—
3136	C	36.51 x	60.32 x	3.96 x	9.52 x	—	52264	U	38.00 x	48.00 x	— x	10.00 x	—
52520	U	36.51 x	77.79 x	— x	7.93 x	—	50389	U031	38.00 x	49.00 x	— x	8.00 x	—
3108	C	36.51 x	102.81 x	5.50 x	21.00 x	—	50389	U006	38.00 x	49.00 x	— x	9.00 x	—
50356	U001	36.69 x	55.56 x	— x	7.94 x	—	51458	U	38.00 x	50.00 x	— x	6.00 x	—
55506	U019	36.69 x	61.91 x	— x	9.53 x	—	50869	U002	38.00 x	50.00 x	— x	6.00 x	—
8369	V	36.90 x	60.50 x	— x	8.60 x	—	55541	U002	38.00 x	50.00 x	— x	6.00 x	—
55507	U031	37.00 x	44.00 x	— x	4.00 x	—	55762	U005	38.00 x	50.00 x	— x	6.00 x	—
59324	U002	37.00 x	44.70 x	— x	3.20 x	—	55542	U04A	38.00 x	50.00 x	— x	6.00 x	—
55508	U002	37.00 x	45.00 x	— x	5.00 x	—	51588	U04A	38.00 x	50.00 x	— x	6.50 x	—
55509	U007	37.00 x	45.00 x	— x	9.00 x	—	51588	U04A	38.00 x	50.00 x	— x	6.50 x	—
55510	U008	37.00 x	45.00 x	— x	9.00 x	—	51680	U003	38.00 x	50.00 x	— x	8.00 x	—
55511	U007	37.00 x	45.00 x	— x	10.00 x	—	55763	U004	38.00 x	50.00 x	— x	8.00 x	—
55512	U008	37.00 x	45.00 x	— x	10.00 x	—	51680	U031	38.00 x	50.00 x	— x	8.00 x	—
50487	U031	37.00 x	46.50 x	— x	4.50 x	—	55764	U001	38.00 x	50.00 x	— x	9.00 x	—
59394	UL	37.00 x	47.00 x	— x	9.00 x	—	55765	U002	38.00 x	50.00 x	— x	9.00 x	—



Cód	Mod	Di x	De x	Esp. x	Ha1 x	Ha2	Cód	Mod	Di x	De x	Esp. x	Ha1 x	Ha2
55766	U007	38.00 x	50.00 x	— x	9.00 x	—	52823	U	38.10 x	47.68 x	— x	8.50 x	—
55767	U006	38.00 x	50.00 x	— x	10.00 x	—	52823	U002	38.10 x	47.68 x	— x	8.50 x	6.00
51800	U006	38.00 x	50.50 x	— x	7.00 x	6.50	55801	U004	38.10 x	49.21 x	— x	6.35 x	—
52881	U	38.00 x	50.80 x	— x	14.50 x	—	55802	U005	38.10 x	50.00 x	— x	10.00 x	—
55769	U002	38.00 x	51.00 x	— x	8.00 x	—	8042	V	38.10 x	50.80 x	— x	6.00 x	—
55768	U04A	38.00 x	51.00 x	— x	8.00 x	—	55803	U001	38.10 x	50.80 x	— x	6.35 x	—
53222	U002	38.00 x	52.00 x	— x	9.00 x	—	51231	U003	38.10 x	50.80 x	— x	6.35 x	—
3006	C	38.00 x	52.00 x	2.00 x	10.00 x	—	52166	U004	38.10 x	50.80 x	— x	6.35 x	—
55770	U001	38.00 x	53.00 x	— x	12.00 x	—	52166	U004	38.10 x	50.80 x	— x	6.35 x	—
8069	V	38.00 x	54.00 x	— x	7.00 x	—	52699	U04A	38.10 x	50.80 x	— x	6.35 x	—
52701	U002	38.00 x	54.00 x	— x	13.00 x	—	51365	U	38.10 x	50.80 x	— x	7.94 x	7.00
52015	U	38.00 x	54.50 x	— x	7.00 x	—	50454	U001	38.10 x	50.80 x	— x	7.94 x	—
52015	U056	38.00 x	54.50 x	— x	7.00 x	—	51374	U001	38.10 x	50.80 x	— x	9.50 x	—
55559	U001	38.00 x	55.00 x	— x	10.00 x	—	50748	U	38.10 x	50.80 x	— x	9.52 x	—
55771	U004	38.00 x	55.00 x	— x	10.00 x	—	51374	U001	38.10 x	50.80 x	— x	9.52 x	—
55745	UL	38.00 x	55.00 x	— x	10.00 x	—	55804	U002	38.10 x	50.80 x	— x	9.53 x	—
8394	V	38.00 x	55.00 x	— x	10.00 x	—	55805	U004	38.10 x	50.80 x	— x	9.53 x	—
55643	U002	38.00 x	55.80 x	— x	7.00 x	—	50385	U004	38.10 x	50.80 x	— x	10.32 x	—
55772	U001	38.00 x	56.00 x	— x	9.00 x	—	50385	U031	38.10 x	50.80 x	— x	10.32 x	—
55773	U002	38.00 x	56.00 x	— x	9.00 x	—	55806	U004	38.10 x	50.80 x	— x	11.11 x	—
55774	U001	38.00 x	56.00 x	— x	10.00 x	—	6393	CH	38.10 x	50.80 x	— x	11.50 x	—
55775	U002	38.00 x	56.00 x	— x	10.00 x	—	—	CH	38.10 x	50.80 x	— x	24.00 x	—
55776	U002	38.00 x	57.00 x	— x	12.00 x	—	—	CH	38.10 x	50.80 x	— x	25.50 x	—
—	CH	38.00 x	57.00 x	— x	38.00 x	—	6069	CH	38.10 x	50.80 x	— x	28.58 x	—
—	CH	38.00 x	57.00 x	— x	60.50 x	—	—	CH	38.10 x	50.80 x	— x	58.50 x	—
8127	V	38.00 x	58.00 x	— x	9.00 x	—	—	CH	38.10 x	51.50 x	— x	28.50 x	—
8127	V	38.00 x	58.00 x	— x	9.40 x	—	8378	V	38.10 x	53.97 x	— x	6.35 x	—
51709	U001	38.00 x	58.00 x	— x	10.00 x	—	8101	V	38.10 x	53.97 x	— x	7.40 x	—
55777	U002	38.00 x	58.00 x	— x	10.00 x	—	8101	V	38.10 x	53.97 x	— x	7.40 x	—
55778	U019	38.00 x	58.00 x	— x	10.00 x	—	50212	U056	38.10 x	53.97 x	— x	7.94 x	—
59452	U002	38.00 x	58.00 x	— x	10.30 x	—	50813	U004	38.10 x	53.97 x	— x	12.70 x	—
55779	U	38.00 x	58.00 x	— x	11.00 x	—	53417	U004	38.10 x	53.98 x	— x	7.94 x	—
51672	U004	38.00 x	58.00 x	— x	12.00 x	—	55807	U004	38.10 x	53.98 x	— x	12.70 x	—
55780	U001	38.00 x	58.00 x	— x	15.00 x	—	6034	CH	38.10 x	53.98 x	— x	22.23 x	—
55781	U002	38.00 x	58.00 x	— x	15.00 x	—	—	CH	38.10 x	53.98 x	— x	39.50 x	—
6039	CH	38.00 x	58.00 x	— x	21.00 x	—	55808	U019	38.10 x	55.56 x	— x	6.35 x	—
50627	U003	38.00 x	59.00 x	— x	17.00 x	—	8007	V	38.10 x	57.15 x	— x	7.94 x	—
50634	U003	38.00 x	59.00 x	— x	17.00 x	—	—	U04A	38.10 x	57.15 x	— x	15.87 x	—
3412	C	38.00 x	60.00 x	3.00 x	10.00 x	—	—	CH	38.10 x	57.15 x	— x	32.00 x	—
55782	U001	38.00 x	60.00 x	— x	12.00 x	—	6203	CH	38.10 x	57.15 x	— x	44.45 x	—
55783	U002	38.00 x	60.00 x	— x	12.00 x	—	6203	CH	38.10 x	57.15 x	— x	44.45 x	—
55784	U001	38.00 x	62.00 x	— x	12.00 x	—	55736	U04A	38.10 x	63.50 x	— x	7.94 x	—
55785	U002	38.00 x	62.00 x	— x	12.00 x	—	—	U04A	38.10 x	63.50 x	— x	12.70 x	—
55786	U001	38.00 x	63.00 x	— x	10.00 x	—	—	CH	38.10 x	66.68 x	— x	47.50 x	—
6255	CH	38.00 x	63.50 x	— x	25.00 x	—	3118	C	38.10 x	69.95 x	3.00 x	9.52 x	—
52376	U047	38.00 x	64.00 x	— x	10.60 x	—	50292	U029	38.10 x	71.44 x	— x	6.35 x	—
55787	U003	38.00 x	65.00 x	— x	12.00 x	—	3166	C	38.10 x	76.20 x	2.50 x	14.30 x	—
55788	U001	38.00 x	65.00 x	— x	14.00 x	—	3166	C	38.10 x	76.20 x	2.50 x	14.30 x	—
55789	U002	38.00 x	65.00 x	— x	14.00 x	—	3434	C	38.10 x	76.20 x	— x	16.67 x	—
55790	U004	38.00 x	65.00 x	— x	15.00 x	—	3434	C	38.10 x	76.20 x	— x	16.67 x	—
55791	U001	38.00 x	68.00 x	— x	12.00 x	—	3206	C	38.10 x	76.20 x	4.76 x	17.46 x	—
55792	U002	38.00 x	68.00 x	— x	12.00 x	—	51722	U056	38.10 x	96.00 x	— x	27.00 x	—
55793	U001	38.00 x	70.00 x	— x	10.00 x	—	3243	C	38.10 x	101.60 x	3.17 x	19.05 x	—
55794	U002	38.00 x	70.00 x	— x	10.00 x	—	52914	U	38.50 x	44.70 x	— x	6.35 x	—
55795	U001	38.00 x	70.00 x	— x	16.00 x	—	55809	U001	38.50 x	45.50 x	— x	5.00 x	—
55796	U002	38.00 x	70.00 x	— x	16.00 x	—	51220	U005	38.50 x	49.00 x	— x	9.00 x	—
55797	U001	38.00 x	71.00 x	— x	15.00 x	—	51979	U031	38.50 x	49.60 x	— x	6.00 x	—
55798	U002	38.00 x	71.00 x	— x	15.00 x	—	51979	U031	38.50 x	49.60 x	— x	6.00 x	—
3086	C	38.00 x	71.00 x	6.00 x	20.00 x	—	51069	U001	38.50 x	50.00 x	— x	5.70 x	—
3182	C	38.00 x	76.00 x	3.00 x	12.70 x	—	55810	U002	38.50 x	54.00 x	— x	10.00 x	—
52914	U	38.10 x	44.45 x	— x	6.35 x	—	53097	U077	38.50 x	56.00 x	— x	6.00 x	—
55799	U002	38.10 x	46.04 x	— x	3.97 x	—	53097	U077	38.50 x	56.00 x	— x	7.00 x	—
—	U04A	38.10 x	47.60 x	— x	6.70 x	—	53255	U002	38.60 x	46.00 x	— x	3.20 x	—
51922	U003	38.10 x	47.60 x	— x	9.50 x	—	55811	U001	39.00 x	45.00 x	— x	4.00 x	—
55590	U04A	38.10 x	47.62 x	— x	4.76 x	—	55812	U002	39.00 x	45.00 x	— x	4.00 x	—
—	U04A	38.10 x	47.63 x	— x	7.94 x	—	55813	U007	39.00 x	47.00 x	— x	13.50 x	—
55800	U004	38.10 x	47.63 x	— x	9.92 x	—	55814	U008	39.00 x	47.00 x	— x	13.50 x	—



Cód	Mod	Di x	De x	Esp. x	Ha1 x	Ha2	Cód	Mod	Di x	De x	Esp. x	Ha1 x	Ha2
55815	U001	39.00 x	48.00 x	— x	8.00 x	—	52170	U	40.00 x	48.00 x	— x	12.00 x	—
55816	U002	39.00 x	48.00 x	— x	8.00 x	—	55846	U007	40.00 x	48.00 x	— x	13.50 x	—
59442	U032	39.00 x	48.00 x	— x	10.00 x	—	55847	U008	40.00 x	48.00 x	— x	13.50 x	—
55817	U004	39.00 x	48.50 x	— x	6.60 x	—	55581	UL	40.00 x	48.50 x	— x	4.80 x	6.80
50959	U008	39.00 x	49.00 x	— x	7.00 x	5.00	55848	U008	40.00 x	49.00 x	— x	7.00 x	—
55818	U003	39.00 x	50.00 x	— x	5.00 x	—	51335	U028	40.00 x	49.00 x	— x	7.00 x	—
55819	U001	39.00 x	50.00 x	— x	5.50 x	—	55679	U031	40.00 x	49.00 x	— x	7.00 x	—
50239	U031	39.00 x	51.00 x	— x	9.00 x	—	50040	U001	40.00 x	49.00 x	— x	10.00 x	—
51980	U002	39.00 x	53.00 x	— x	5.00 x	—	51663	U006	40.00 x	49.00 x	— x	10.00 x	—
55820	U002	39.00 x	54.00 x	— x	9.00 x	—	55849	U007	40.00 x	49.00 x	— x	10.00 x	—
51949	U001	39.00 x	55.00 x	— x	10.00 x	—	55850	U008	40.00 x	49.00 x	— x	10.00 x	—
55821	U001	39.00 x	55.00 x	— x	10.00 x	—	51614	U	40.00 x	50.00 x	— x	5.00 x	—
55822	U002	39.00 x	55.00 x	— x	10.00 x	—	50994	U	40.00 x	50.00 x	— x	5.00 x	—
—	CH	39.00 x	55.00 x	— x	38.00 x	—	55674	U	40.00 x	50.00 x	— x	5.00 x	7.50
55823	U001	39.00 x	56.00 x	— x	8.00 x	—	55851	U001	40.00 x	50.00 x	— x	5.00 x	—
8176	V	39.00 x	58.40 x	— x	10.00 x	—	55852	U002	40.00 x	50.00 x	— x	5.00 x	—
6141	CH	39.00 x	58.40 x	— x	30.00 x	—	51767	U004	40.00 x	50.00 x	— x	5.00 x	—
55824	U001	39.00 x	60.00 x	— x	10.00 x	—	51767	U004	40.00 x	50.00 x	— x	5.00 x	—
55825	U002	39.00 x	60.00 x	— x	10.00 x	—	50800	U006	40.00 x	50.00 x	— x	5.00 x	7.00
55826	U001	39.00 x	72.00 x	— x	15.00 x	—	50326	U008	40.00 x	50.00 x	— x	5.00 x	7.00
55827	U002	39.00 x	72.00 x	— x	15.00 x	—	50326	U008	40.00 x	50.00 x	— x	5.00 x	7.00
52001	U004	39.30 x	69.50 x	— x	11.00 x	—	51560	U007	40.00 x	50.00 x	— x	6.00 x	7.00
55828	U002	39.50 x	52.00 x	— x	5.00 x	—	51714	U065	40.00 x	50.00 x	— x	6.00 x	—
3437	C	39.50 x	64.00 x	3.00 x	11.00 x	—	51952	UL	40.00 x	50.00 x	— x	6.00 x	8.00
—	CH	39.50 x	68.50 x	— x	49.00 x	—	51952	UL	40.00 x	50.00 x	— x	6.00 x	8.00
3170	C	39.50 x	101.60 x	4.00 x	16.00 x	—	51952	UL	40.00 x	50.00 x	— x	6.00 x	8.00
3170	C	39.50 x	101.60 x	— x	16.00 x	—	51952	UL	40.00 x	50.00 x	— x	6.00 x	8.00
6195	CH	39.63 x	64.95 x	— x	38.00 x	—	52873	U004	40.00 x	50.00 x	— x	6.30 x	—
6195	CH	39.63 x	64.95 x	— x	38.00 x	—	52873	U004	40.00 x	50.00 x	— x	6.30 x	—
55829	U002	39.69 x	49.21 x	— x	4.76 x	—	55556	U007	40.00 x	50.00 x	— x	6.40 x	7.40
55830	U004	39.69 x	49.61 x	— x	12.70 x	—	51590	U005	40.00 x	50.00 x	— x	6.50 x	7.00
52999	U004	39.69 x	50.80 x	— x	9.50 x	—	55675	U030	40.00 x	50.00 x	— x	6.50 x	—
50356	U001	39.69 x	55.56 x	— x	7.94 x	—	51060	U033	40.00 x	50.00 x	— x	6.50 x	7.00
50480	U001	39.69 x	55.56 x	— x	10.32 x	—	51786	U	40.00 x	50.00 x	— x	7.00 x	—
6079	CH	39.69 x	55.56 x	— x	23.81 x	—	55853	U001	40.00 x	50.00 x	— x	7.00 x	—
55831	U019	39.69 x	58.74 x	— x	9.53 x	—	51457	U004	40.00 x	50.00 x	— x	7.00 x	—
3001	C	39.69 x	63.50 x	5.00 x	12.70 x	—	51786	U006	40.00 x	50.00 x	— x	7.00 x	5.00
53137	U04A	39.70 x	34.92 x	— x	3.97 x	—	51625	U008	40.00 x	50.00 x	— x	7.00 x	6.00
55832	U004	39.70 x	51.00 x	— x	8.00 x	—	52498	U008	40.00 x	50.00 x	— x	7.00 x	—
6238	CH	39.70 x	51.60 x	— x	18.00 x	—	50155	U008	40.00 x	50.00 x	— x	7.00 x	—
6411	CH	39.70 x	65.10 x	— x	50.00 x	—	55854	U008	40.00 x	50.00 x	— x	7.00 x	—
55833	U001	39.80 x	49.00 x	— x	5.00 x	—	52287	U011	40.00 x	50.00 x	— x	7.00 x	4.00
55834	U002	39.80 x	49.00 x	— x	5.00 x	—	51617	U056	40.00 x	50.00 x	— x	7.00 x	—
52197	U001	39.80 x	58.00 x	— x	10.00 x	—	8279	V	40.00 x	50.00 x	— x	7.00 x	—
52468	U	39.94 x	50.75 x	— x	7.93 x	—	50169	U007	40.00 x	50.00 x	— x	7.20 x	—
53270	U005	39.94 x	50.75 x	— x	7.93 x	—	52467	U	40.00 x	50.00 x	— x	7.50 x	—
55835	U007	39.94 x	50.75 x	— x	7.93 x	—	52100	U001	40.00 x	50.00 x	— x	8.00 x	—
55836	U008	39.94 x	50.75 x	— x	7.93 x	—	55855	U04A	40.00 x	50.00 x	— x	8.00 x	—
52392	U	40.00 x	45.00 x	— x	2.60 x	—	51002	U	40.00 x	50.00 x	— x	9.00 x	—
55837	U001	40.00 x	46.00 x	— x	4.00 x	—	52875	U	40.00 x	50.00 x	— x	9.00 x	—
55838	U002	40.00 x	46.00 x	— x	4.00 x	—	55754	U	40.00 x	50.00 x	— x	9.00 x	—
55839	U001	40.00 x	47.00 x	— x	4.50 x	—	52875	U04A	40.00 x	50.00 x	— x	9.00 x	—
51223	U002	40.00 x	48.00 x	— x	5.00 x	—	52999	U	40.00 x	50.00 x	— x	9.30 x	—
51223	U002	40.00 x	48.00 x	— x	5.00 x	—	52654	U	40.00 x	50.00 x	— x	9.50 x	—
52524	UL	40.00 x	48.00 x	— x	5.00 x	2.00	52654	U	40.00 x	50.00 x	— x	9.50 x	—
52439	U	40.00 x	48.00 x	— x	6.50 x	5.00	52654	U	40.00 x	50.00 x	— x	9.50 x	—
53148	U	40.00 x	48.00 x	— x	7.00 x	—	52654	U031	40.00 x	50.00 x	— x	9.50 x	—
52187	U	40.00 x	48.00 x	— x	8.00 x	4.50	52325	U002	40.00 x	50.00 x	— x	10.00 x	—
55840	U001	40.00 x	48.00 x	— x	8.00 x	—	51496	U004	40.00 x	50.00 x	— x	10.00 x	—
55841	U006	40.00 x	48.00 x	— x	8.00 x	—	55856	U004	40.00 x	50.00 x	— x	10.00 x	—
51112	U	40.00 x	48.00 x	— x	10.00 x	—	51107	U024	40.00 x	50.00 x	— x	10.00 x	—
55842	U002	40.00 x	48.00 x	— x	10.00 x	—	52538	U031	40.00 x	50.00 x	— x	10.00 x	—
55843	U005	40.00 x	48.00 x	— x	11.00 x	—	52325	U04A	40.00 x	50.00 x	— x	10.00 x	—
51814	U005	40.00 x	48.00 x	— x	11.00 x	10.20	52325	U04A	40.00 x	50.00 x	— x	10.00 x	—
55844	U006	40.00 x	48.00 x	— x	11.00 x	—	51177	U	40.00 x	50.00 x	— x	11.20 x	—
55845	U004	40.00 x	48.00 x	— x	11.10 x	—	52805	U	40.00 x	50.00 x	— x	17.00 x	—
50447	U028	40.00 x	48.00 x	— x	11.80 x	—	—	CH	40.00 x	50.00 x	— x	17.00 x	—





Cód	Mod	Di x	De x	Esp. x	Ha1 x	Ha2	Cód	Mod	Di x	De x	Esp. x	Ha1 x	Ha2
55857	U005	40.00 x	50.00 x	— x	20.00 x	—	55884	U001	40.00 x	56.00 x	— x	10.00 x	—
55858	U006	40.00 x	50.00 x	— x	20.00 x	—	55885	U002	40.00 x	56.00 x	— x	10.00 x	—
55859	U006	40.00 x	50.00 x	— x	20.00 x	—	55886	U004	40.00 x	56.00 x	— x	10.00 x	—
55860	U002	40.00 x	51.00 x	— x	6.50 x	—	55888	U006	40.00 x	56.00 x	— x	12.00 x	—
52522	U031	40.00 x	51.00 x	— x	7.50 x	9.00	6119	CH	40.00 x	56.00 x	— x	16.50 x	—
55861	U004	40.00 x	51.00 x	— x	8.00 x	—	55889	U001	40.00 x	56.00 x	— x	20.00 x	—
8335	V	40.00 x	52.00 x	— x	4.00 x	—	6322	CH	40.00 x	56.00 x	— x	42.00 x	—
55862	U001	40.00 x	52.00 x	— x	7.50 x	—	50152	U003	40.00 x	56.50 x	— x	11.00 x	—
55863	U002	40.00 x	52.00 x	— x	7.50 x	—	55890	U004	40.00 x	58.00 x	— x	8.00 x	—
55864	U001	40.00 x	52.00 x	— x	8.00 x	—	55891	U031	40.00 x	58.00 x	— x	8.00 x	—
55866	U001	40.00 x	52.00 x	— x	8.00 x	—	50257	U001	40.00 x	58.00 x	— x	10.00 x	—
55865	U002	40.00 x	52.00 x	— x	8.00 x	—	50223	U002	40.00 x	58.00 x	— x	10.00 x	—
55867	U003	40.00 x	52.00 x	— x	8.00 x	—	8383	V	40.00 x	58.00 x	— x	11.00 x	—
51846	U005	40.00 x	52.00 x	— x	8.00 x	—	—	CH	40.00 x	58.00 x	— x	38.00 x	—
51846	U005	40.00 x	52.00 x	— x	8.00 x	9.00	—	ESPE	40.00 x	60.00 x	— x	7.00 x	—
52126	U031	40.00 x	52.00 x	— x	8.00 x	—	2157	C	40.00 x	60.00 x	— x	8.00 x	—
55868	U005	40.00 x	52.00 x	— x	9.00 x	—	3107	C	40.00 x	60.00 x	2.80 x	8.00 x	—
55869	U005	40.00 x	52.00 x	— x	9.00 x	—	3305	C	40.00 x	60.00 x	— x	8.00 x	—
55870	U001	40.00 x	52.00 x	— x	10.00 x	—	52011	U	40.00 x	60.00 x	— x	8.00 x	—
55871	U006	40.00 x	52.00 x	— x	10.00 x	—	8306	V	40.00 x	60.00 x	— x	8.00 x	—
6174	CH	40.00 x	52.00 x	— x	22.50 x	—	3414	C	40.00 x	60.00 x	— x	10.00 x	—
6174	CH	40.00 x	52.00 x	— x	22.50 x	—	55893	U	40.00 x	60.00 x	— x	10.00 x	—
6174	CH	40.00 x	52.00 x	— x	22.50 x	—	50076	U001	40.00 x	60.00 x	— x	10.00 x	—
—	CH	40.00 x	52.50 x	— x	25.50 x	—	53324	U001	40.00 x	60.00 x	— x	10.00 x	—
F6754/2	J	40.00 x	53.00 x	— x	9.00 x	15.00	51929	U002	40.00 x	60.00 x	— x	10.00 x	—
55872	U004	40.00 x	53.50 x	— x	8.50 x	—	55892	U002	40.00 x	60.00 x	— x	10.00 x	—
—	CH	40.00 x	53.50 x	— x	20.00 x	—	55894	U004	40.00 x	60.00 x	— x	10.00 x	—
—	CH	40.00 x	53.50 x	— x	32.50 x	—	55895	U019	40.00 x	60.00 x	— x	10.00 x	—
50489	U040	40.00 x	54.00 x	— x	12.00 x	—	—	U04A	40.00 x	60.00 x	— x	10.00 x	—
52527	U002	40.00 x	54.50 x	— x	10.00 x	—	8310	V	40.00 x	60.00 x	— x	10.00 x	—
55874	U004	40.00 x	54.50 x	— x	10.00 x	—	8368	V	40.00 x	60.00 x	— x	11.00 x	—
55562	UL	40.00 x	55.00 x	— x	2.80 x	11.20	51750	U	40.00 x	60.00 x	— x	12.00 x	—
59358	UL	40.00 x	55.00 x	— x	6.00 x	10.00	52333	U002	40.00 x	60.00 x	— x	12.00 x	—
59358	UL	40.00 x	55.00 x	— x	6.00 x	10.00	55896	U003	40.00 x	60.00 x	— x	12.00 x	—
8088	V	40.00 x	55.00 x	— x	6.00 x	—	55897	U004	40.00 x	60.00 x	— x	12.00 x	—
55875	U005	40.00 x	55.00 x	— x	7.00 x	—	53129	U002	40.00 x	60.00 x	— x	13.00 x	—
55876	U005	40.00 x	55.00 x	— x	7.00 x	—	55898	U001	40.00 x	60.00 x	— x	15.00 x	—
50528	U001	40.00 x	55.00 x	— x	7.50 x	—	55899	U002	40.00 x	60.00 x	— x	15.00 x	—
51970	U002	40.00 x	55.00 x	— x	8.00 x	—	50548	U037	40.00 x	60.00 x	— x	17.30 x	10.00
55877	U002	40.00 x	55.00 x	— x	8.00 x	—	50548	U060	40.00 x	60.00 x	— x	17.30 x	10.00
50842	U002	40.00 x	55.00 x	— x	9.00 x	—	55900	U001	40.00 x	60.00 x	— x	18.00 x	—
50842	U002	40.00 x	55.00 x	— x	9.00 x	—	55901	U002	40.00 x	60.00 x	— x	18.00 x	—
51686	U	40.00 x	55.00 x	— x	10.00 x	—	—	CH	40.00 x	60.00 x	— x	41.50 x	—
55878	U001	40.00 x	55.00 x	— x	10.00 x	—	55902	U002	40.00 x	62.00 x	— x	10.00 x	—
55879	U002	40.00 x	55.00 x	— x	10.00 x	—	55903	U001	40.00 x	62.00 x	— x	12.00 x	—
50609	U004	40.00 x	55.00 x	— x	10.00 x	—	55904	U002	40.00 x	62.00 x	— x	12.00 x	—
50835	U004	40.00 x	55.00 x	— x	10.00 x	—	55905	U002	40.00 x	62.00 x	— x	13.00 x	—
50177	U004	40.00 x	55.00 x	— x	10.00 x	—	55906	U004	40.00 x	62.00 x	— x	13.00 x	—
50177	U004	40.00 x	55.00 x	— x	10.00 x	—	55907	U001	40.00 x	63.00 x	— x	12.00 x	—
52390	U006	40.00 x	55.00 x	— x	10.00 x	—	55908	U002	40.00 x	63.00 x	— x	12.00 x	—
52742	U006	40.00 x	55.00 x	— x	10.00 x	—	55909	U001	40.00 x	64.00 x	— x	12.00 x	—
50673	U006	40.00 x	55.00 x	— x	10.00 x	—	55910	U002	40.00 x	64.00 x	— x	12.00 x	—
55880	U008	40.00 x	55.00 x	— x	10.00 x	—	51823	U	40.00 x	64.00 x	— x	14.00 x	—
50673	U031	40.00 x	55.00 x	— x	10.00 x	—	6464	CH	40.00 x	64.00 x	— x	90.00 x	—
50673	U031	40.00 x	55.00 x	— x	10.00 x	—	50278	U047	40.00 x	64.50 x	— x	24.00 x	—
50508	U040	40.00 x	55.00 x	— x	10.00 x	—	51794	U	40.00 x	65.00 x	— x	10.00 x	—
52740	U04A	40.00 x	55.00 x	— x	10.00 x	—	55911	U001	40.00 x	65.00 x	— x	10.00 x	—
51437	U003	40.00 x	55.00 x	— x	10.50 x	—	8011	V	40.00 x	65.00 x	— x	10.00 x	—
55881	U003	40.00 x	55.00 x	— x	10.50 x	—	55912	U002	40.00 x	65.00 x	— x	12.00 x	—
6140	CH	40.00 x	55.00 x	— x	16.00 x	—	55913	U019	40.00 x	65.00 x	— x	12.00 x	—
6140	CH	40.00 x	55.00 x	— x	28.00 x	—	55914	U001	40.00 x	65.00 x	— x	12.50 x	—
8161	V	40.00 x	56.00 x	— x	5.50 x	—	55915	U001	40.00 x	65.00 x	— x	18.00 x	—
8161	V	40.00 x	56.00 x	— x	5.50 x	—	55916	U004	40.00 x	65.00 x	— x	18.00 x	—
8291	V	40.00 x	56.00 x	— x	7.00 x	—	50662	U053	40.00 x	65.00 x	— x	24.00 x	—
55882	U001	40.00 x	56.00 x	— x	8.00 x	—	50662	U053	40.00 x	65.00 x	— x	24.00 x	—
50802	U009	40.00 x	56.00 x	— x	8.00 x	—	51068	U004	40.00 x	68.00 x	— x	12.00 x	—
55883	U031	40.00 x	56.00 x	— x	8.00 x	—	55917	U001	40.00 x	68.00 x	— x	15.00 x	—



Cód	Mod	Di x	De x	Esp. x	Ha1 x	Ha2	Cód	Mod	Di x	De x	Esp. x	Ha1 x	Ha2
55918	U002	40.00 x	68.00 x	— x	15.00 x	—	F416	W	41.27 x	53.97 x	— x	6.00 x	5.40
51761	U002	40.00 x	70.00 x	— x	12.00 x	—	52254	U004	41.27 x	53.97 x	— x	6.35 x	—
55919	U002	40.00 x	70.00 x	— x	14.50 x	—	52254	U004	41.27 x	53.97 x	— x	6.35 x	—
55920	U001	40.00 x	70.00 x	— x	15.00 x	—	8206	V	41.27 x	53.97 x	— x	6.35 x	—
55921	U001	40.00 x	70.00 x	— x	20.00 x	—	59314	U04A	41.27 x	53.97 x	— x	9.52 x	—
55922	U002	40.00 x	70.00 x	— x	20.00 x	—	3223	C	41.27 x	53.97 x	2.38 x	9.53 x	—
6219	CH	40.00 x	70.00 x	— x	50.00 x	—	51568	U	41.27 x	53.98 x	— x	9.53 x	—
55923	U001	40.00 x	80.00 x	— x	20.00 x	—	6240	CH	41.27 x	55.56 x	— x	34.92 x	—
55924	U002	40.00 x	80.00 x	— x	20.00 x	—	53109	U	41.27 x	57.94 x	— x	9.52 x	—
55925	U001	40.00 x	82.00 x	— x	20.00 x	—	6226	CH	41.27 x	69.85 x	— x	50.80 x	—
55926	U002	40.00 x	82.00 x	— x	20.00 x	—	55948	U006	41.28 x	50.80 x	— x	4.55 x	—
55927	U001	40.00 x	88.00 x	— x	24.00 x	—	52391	U	41.28 x	50.80 x	— x	4.76 x	—
55928	U002	40.00 x	88.00 x	— x	24.00 x	—	55949	U002	41.28 x	50.80 x	— x	4.76 x	—
55929	U001	40.00 x	94.00 x	— x	27.00 x	—	52391	U004	41.28 x	50.80 x	— x	4.76 x	—
55930	U002	40.00 x	94.00 x	— x	27.00 x	—	55951	U004	41.28 x	50.80 x	— x	4.76 x	—
53119	U029	40.00 x	100.00 x	— x	15.00 x	—	55950	U005	41.28 x	50.80 x	— x	4.76 x	—
53119	U029	40.00 x	100.00 x	— x	15.00 x	—	53175	U	41.28 x	50.80 x	— x	7.14 x	—
3127	C	40.00 x	103.00 x	— x	12.00 x	—	—	U04A	41.28 x	50.80 x	— x	7.90 x	—
3074	C	40.00 x	103.00 x	5.00 x	21.00 x	—	—	U04A	41.28 x	50.80 x	— x	9.52 x	—
3268	C	40.00 x	112.00 x	— x	10.00 x	—	55952	U004	41.28 x	51.99 x	— x	9.92 x	—
3079	C	40.00 x	130.00 x	6.50 x	27.00 x	—	55953	U007	41.28 x	53.98 x	— x	6.35 x	—
3112	C	40.00 x	164.90 x	— x	17.00 x	—	—	CH	41.28 x	53.98 x	— x	22.23 x	—
55931	U001	40.08 x	50.80 x	— x	5.15 x	—	52559	U04A	41.28 x	57.15 x	— x	7.94 x	—
51096	U	40.30 x	50.80 x	— x	7.30 x	—	55954	U001	41.28 x	57.15 x	— x	9.92 x	—
55932	U003	40.48 x	48.82 x	— x	6.75 x	—	55955	U002	41.28 x	57.15 x	— x	9.92 x	—
55933	U002	40.50 x	48.00 x	— x	8.00 x	—	6051	CH	41.28 x	57.15 x	— x	12.70 x	—
55934	U002	40.50 x	48.50 x	— x	5.00 x	—	6005	CH	41.28 x	57.15 x	— x	19.05 x	—
55935	U	40.50 x	50.00 x	— x	4.00 x	5.50	55956	U019	41.28 x	57.94 x	— x	9.53 x	—
50296	U011	40.50 x	50.00 x	— x	5.50 x	4.00	53015	U	41.28 x	60.33 x	— x	9.52 x	—
55936	U006	40.50 x	50.00 x	— x	7.00 x	—	51716	U005	41.28 x	60.33 x	— x	9.52 x	—
55937	U001	40.50 x	51.00 x	— x	15.00 x	—	55957	U002	41.28 x	60.33 x	— x	9.53 x	—
6142	CH	40.50 x	60.40 x	— x	34.92 x	—	55958	U019	41.28 x	60.33 x	— x	9.53 x	—
53294	U	40.60 x	50.80 x	— x	6.35 x	—	55959	U019	41.28 x	63.50 x	— x	11.11 x	—
55938	U006	41.00 x	49.00 x	— x	5.50 x	—	3555	C	41.28 x	63.50 x	4.76 x	14.28 x	—
51847	U065	41.00 x	49.50 x	— x	7.00 x	—	6254	CH	41.28 x	66.68 x	— x	38.50 x	—
59248	U002	41.00 x	50.00 x	— x	3.30 x	—	—	CH	41.28 x	71.44 x	— x	48.00 x	—
55939	U002	41.00 x	50.00 x	— x	4.50 x	—	3354	C	41.28 x	203.20 x	— x	19.05 x	—
55940	U004	41.00 x	50.00 x	— x	4.50 x	—	52973	U	41.30 x	50.80 x	— x	8.00 x	—
52990	U	41.00 x	50.00 x	— x	6.00 x	—	52973	U	41.30 x	50.80 x	— x	8.00 x	—
52990	U002	41.00 x	50.00 x	— x	6.00 x	—	6277	CH	41.30 x	57.15 x	— x	17.00 x	—
55941	U002	41.00 x	50.00 x	— x	6.00 x	—	6254	CH	41.30 x	66.70 x	— x	60.30 x	—
51218	U007	41.00 x	50.00 x	— x	7.00 x	6.40	6254	CH	41.30 x	66.70 x	— x	61.75 x	—
51478	U	41.00 x	50.00 x	— x	9.00 x	—	55960	U007	41.50 x	49.50 x	— x	7.00 x	—
6419	CH	41.00 x	50.20 x	— x	10.00 x	—	55961	U004	41.50 x	51.00 x	— x	6.30 x	—
50957	U	41.00 x	50.80 x	— x	6.00 x	—	51407	U	41.50 x	51.00 x	— x	10.50 x	—
55942	U004	41.00 x	51.00 x	— x	5.00 x	—	55962	U002	41.50 x	52.50 x	— x	5.00 x	—
51634	U028	41.00 x	51.00 x	— x	6.00 x	—	F2350	J	41.50 x	52.70 x	— x	9.30 x	15.00
55943	U003	41.00 x	51.00 x	— x	8.00 x	—	55963	U002	41.50 x	55.50 x	— x	6.50 x	—
52129	U002	41.00 x	52.00 x	— x	7.00 x	—	55964	U	41.50 x	56.60 x	— x	8.50 x	10.00
51376	U002	41.00 x	53.00 x	— x	9.00 x	—	50498	U001	41.50 x	56.60 x	— x	10.00 x	—
52195	U002	41.00 x	53.00 x	— x	15.00 x	9.00	50498	U021	41.50 x	56.60 x	— x	10.00 x	8.50
55742	U	41.00 x	55.00 x	— x	7.00 x	—	53284	U053	41.60 x	67.90 x	— x	14.00 x	—
55944	U006	41.00 x	55.00 x	— x	9.00 x	—	55965	U007	42.00 x	48.00 x	— x	8.00 x	—
8277	V	41.00 x	57.00 x	— x	8.00 x	—	55966	U008	42.00 x	48.00 x	— x	8.00 x	—
55945	U007	41.00 x	57.00 x	— x	12.00 x	—	55967	U002	42.00 x	50.00 x	— x	4.50 x	—
55946	U008	41.00 x	57.00 x	— x	12.00 x	—	51056	U031	42.00 x	50.00 x	— x	5.00 x	—
—	CH	41.00 x	57.00 x	— x	38.00 x	—	51056	U031	42.00 x	50.00 x	— x	5.00 x	—
50668	U053	41.00 x	60.30 x	— x	14.00 x	—	50196	U056	42.00 x	50.00 x	— x	5.50 x	—
52998	U	41.20 x	50.80 x	— x	7.00 x	—	55968	U002	42.00 x	50.00 x	— x	6.00 x	—
52998	U005	41.20 x	50.80 x	— x	7.00 x	—	53366	U005	42.00 x	50.00 x	— x	6.00 x	—
55947	U005	41.20 x	50.80 x	— x	7.00 x	—	55969	U005	42.00 x	50.00 x	— x	7.00 x	—
53114	U	41.20 x	54.00 x	— x	3.80 x	—	55970	U006	42.00 x	50.00 x	— x	7.00 x	—
50358	U061	41.27 x	50.80 x	— x	4.76 x	—	52156	U007	42.00 x	50.00 x	— x	7.00 x	5.50
50358	U061	41.27 x	50.80 x	— x	4.76 x	—	50852	U	42.00 x	50.00 x	— x	8.00 x	7.00
51463	U008	41.27 x	50.80 x	— x	5.56 x	—	55971	U005	42.00 x	50.00 x	— x	8.00 x	—
55947	U	41.27 x	50.80 x	— x	6.35 x	7.14	55972	U007	42.00 x	50.00 x	— x	8.00 x	—
50342	U007	41.27 x	50.80 x	— x	7.14 x	6.35	52181	U031	42.00 x	50.00 x	— x	8.00 x	—



Cód	Mod	Di x	De x	Esp. x	Ha1 x	Ha2	Cód	Mod	Di x	De x	Esp. x	Ha1 x	Ha2
55973	U007	42.00 x	50.00 x	— x	10.00 x	—	52466	U047	42.86 x	53.98 x	— x	9.50 x	—
55974	U008	42.00 x	50.00 x	— x	10.00 x	—	56013	U005	42.86 x	53.98 x	— x	9.53 x	—
51626	U028	42.00 x	50.00 x	— x	10.00 x	8.50	56014	U006	42.86 x	53.98 x	— x	9.53 x	—
55975	U005	42.00 x	50.00 x	— x	11.00 x	—	8043	V	42.86 x	57.15 x	— x	6.35 x	—
55976	U006	42.00 x	50.00 x	— x	11.00 x	—	56015	U019	42.86 x	65.09 x	— x	9.53 x	—
55977	U006	42.00 x	50.00 x	— x	80.00 x	—	6325	CH	42.86 x	68.24 x	— x	174.60 x	—
51725	U002	42.00 x	50.50 x	— x	4.50 x	—	56016	U002	43.00 x	49.00 x	— x	7.50 x	—
51083	U003	42.00 x	50.80 x	— x	4.70 x	—	51021	U	43.00 x	50.80 x	— x	5.00 x	—
55978	U002	42.00 x	52.00 x	— x	5.00 x	—	53368	U005	43.00 x	51.00 x	— x	6.00 x	—
51644	U011	42.00 x	52.00 x	— x	7.00 x	—	59398	UL	43.00 x	53.50 x	— x	5.00 x	7.00
53178	U04A	42.00 x	52.00 x	— x	9.00 x	—	8349	V	43.00 x	54.00 x	— x	5.00 x	—
55979	U004	42.00 x	52.00 x	— x	10.00 x	—	55761	UL	43.00 x	55.50 x	— x	7.00 x	10.00
55980	U007	42.00 x	52.00 x	— x	12.00 x	—	56017	U001	43.00 x	56.00 x	— x	6.00 x	—
55981	U008	42.00 x	52.00 x	— x	12.00 x	—	6360	CH	43.00 x	59.00 x	— x	38.00 x	—
51128	U	42.00 x	52.50 x	— x	5.00 x	—	51211	U	43.00 x	60.00 x	— x	8.00 x	—
55983	U002	42.00 x	52.50 x	— x	5.00 x	—	8221	V	43.00 x	60.00 x	— x	8.00 x	—
51989	U	42.00 x	54.00 x	— x	6.00 x	—	—	CH	43.00 x	61.50 x	— x	44.00 x	—
55984	U002	42.00 x	54.00 x	— x	6.00 x	—	8281	V	43.00 x	62.00 x	— x	8.00 x	—
51420	U004	42.00 x	54.00 x	— x	10.00 x	—	53158	U	43.00 x	62.00 x	— x	12.00 x	—
51420	U004	42.00 x	54.00 x	— x	10.00 x	—	53149	U	43.00 x	62.00 x	— x	12.00 x	—
6030	CH	42.00 x	54.00 x	— x	25.00 x	—	56018	U001	43.00 x	63.00 x	— x	10.00 x	—
—	CH	42.00 x	54.00 x	— x	38.30 x	—	56019	U002	43.00 x	63.00 x	— x	10.00 x	—
55985	U001	42.00 x	55.00 x	— x	6.50 x	—	51362	U	43.00 x	63.00 x	— x	11.00 x	—
55986	U002	42.00 x	55.00 x	— x	6.50 x	—	56020	U001	43.00 x	63.00 x	— x	12.50 x	—
55987	U001	42.00 x	55.00 x	— x	8.00 x	—	51011	U001	43.00 x	63.00 x	— x	13.00 x	—
55988	U002	42.00 x	55.00 x	— x	8.00 x	—	56021	U004	43.00 x	65.00 x	— x	16.50 x	—
55989	U007	42.00 x	55.00 x	— x	8.00 x	—	52877	U002	43.00 x	66.00 x	— x	11.00 x	—
—	CH	42.00 x	57.00 x	— x	27.00 x	—	56022	U008	43.00 x	68.00 x	— x	11.50 x	—
8408	V	42.00 x	57.15 x	— x	6.35 x	—	—	U04A	43.50 x	53.00 x	— x	9.00 x	—
55990	U001	42.00 x	58.00 x	— x	15.00 x	—	56023	U002	43.50 x	60.00 x	— x	8.00 x	—
55991	U002	42.00 x	58.00 x	— x	15.00 x	—	8222	V	43.50 x	60.00 x	— x	8.00 x	—
—	CH	42.00 x	58.00 x	— x	38.00 x	—	8403	V	43.50 x	61.00 x	— x	6.50 x	—
52053	U002	42.00 x	60.00 x	— x	4.70 x	—	50302	U031	43.80 x	55.00 x	— x	8.50 x	—
55992	U007	42.00 x	60.00 x	— x	7.00 x	—	50215	U019	43.80 x	60.00 x	— x	11.80 x	—
—	CH	42.00 x	60.00 x	— x	54.20 x	—	53337	U	43.86 x	53.98 x	— x	4.76 x	—
51670	U04A	42.00 x	61.60 x	— x	7.50 x	—	52975	U	44.00 x	50.00 x	— x	4.00 x	—
55993	U019	42.00 x	62.00 x	— x	9.50 x	—	52975	U04A	44.00 x	50.00 x	— x	4.00 x	—
55994	U001	42.00 x	62.00 x	— x	10.00 x	—	53040	U040	44.00 x	50.00 x	— x	9.00 x	—
55995	U001	42.00 x	62.00 x	— x	10.00 x	—	53040	U040	44.00 x	50.00 x	— x	9.00 x	—
55996	U002	42.00 x	62.00 x	— x	10.00 x	—	53280	U	44.00 x	53.00 x	— x	5.00 x	7.00
55998	U	42.00 x	62.00 x	— x	12.00 x	13.00	56024	U031	44.00 x	53.00 x	— x	5.00 x	—
55997	U004	42.00 x	62.00 x	— x	12.00 x	—	50867	U	44.00 x	53.00 x	— x	6.50 x	—
52497	U021	42.00 x	62.00 x	— x	12.00 x	7.00	50867	U	44.00 x	53.00 x	— x	6.50 x	—
50890	U031	42.00 x	62.00 x	— x	12.00 x	—	59406	UL	44.00 x	54.00 x	— x	5.00 x	6.50
52501	U040	42.00 x	62.00 x	— x	12.00 x	—	52635	U	44.00 x	54.00 x	— x	5.16 x	—
50522	U037	42.00 x	62.00 x	— x	13.00 x	12.00	56025	U008	44.00 x	54.00 x	— x	7.00 x	—
55999	U001	42.00 x	62.00 x	— x	18.00 x	—	52744	U	44.00 x	55.00 x	— x	6.00 x	—
56000	U002	42.00 x	62.00 x	— x	18.00 x	—	51486	U057	44.00 x	55.00 x	— x	7.00 x	4.50
56001	U002	42.00 x	62.00 x	— x	18.00 x	—	56036	U007	44.00 x	55.00 x	— x	12.00 x	—
—	CH	42.00 x	62.00 x	— x	56.00 x	—	56037	U008	44.00 x	55.00 x	— x	12.00 x	—
3123	C	42.00 x	64.00 x	3.00 x	15.00 x	—	51982	U002	44.00 x	55.50 x	— x	9.00 x	—
56002	U001	42.00 x	65.00 x	— x	15.00 x	—	56038	U001	44.00 x	56.00 x	— x	6.00 x	—
56003	U002	42.00 x	65.00 x	— x	15.00 x	—	56039	U002	44.00 x	56.00 x	— x	6.00 x	—
3418	C	42.00 x	65.00 x	— x	18.00 x	—	51695	U005	44.00 x	56.00 x	— x	8.00 x	7.00
50884	U031	42.00 x	66.00 x	— x	11.00 x	—	8078	V	44.00 x	58.00 x	— x	6.00 x	—
56004	U001	42.00 x	66.00 x	— x	12.00 x	—	56040	U001	44.00 x	58.00 x	— x	8.00 x	—
56005	U002	42.00 x	66.00 x	— x	12.00 x	—	6016	CH	44.00 x	58.00 x	— x	25.00 x	—
56006	U001	42.00 x	68.00 x	— x	12.00 x	—	56041	U002	44.00 x	59.50 x	— x	8.00 x	—
56007	U002	42.00 x	68.00 x	— x	12.00 x	—	8336	V	44.00 x	60.00 x	— x	6.00 x	—
50982	U002	42.00 x	72.00 x	— x	14.00 x	—	51615	U	44.00 x	60.00 x	— x	8.00 x	—
56008	U001	42.00 x	72.00 x	— x	15.00 x	—	51615	U	44.00 x	60.00 x	— x	8.00 x	—
56009	U002	42.00 x	72.00 x	— x	15.00 x	—	56042	U005	44.00 x	60.00 x	— x	10.00 x	—
52486	U044	42.50 x	53.50 x	— x	15.00 x	—	—	CH	44.00 x	60.00 x	— x	38.00 x	—
56010	U002	42.50 x	57.00 x	— x	13.00 x	—	6239	CH	44.00 x	60.15 x	— x	65.00 x	—
56011	U004	42.50 x	62.00 x	— x	11.00 x	—	8170	V	44.00 x	60.50 x	— x	12.00 x	—
50352	U006	42.86 x	50.80 x	— x	11.51 x	—	6126	CH	44.00 x	60.50 x	— x	36.00 x	—
56012	U005	42.86 x	52.39 x	— x	9.53 x	—	3324	C	44.00 x	61.00 x	— x	9.00 x	—



# Gaxetas

Perfis - Ver Última Página



INCOVE VEDAÇÕES LTDA.

Cód	Mod	Di x	De x	Esp. x	Ha1 x	Ha2	Cód	Mod	Di x	De x	Esp. x	Ha1 x	Ha2
56043	U001	44.00 x	63.00 x	— x	10.00 x	—	56067	U002	44.45 x	63.50 x	— x	7.94 x	—
56044	U002	44.00 x	63.00 x	— x	10.00 x	—	59296	U02A	44.45 x	63.50 x	— x	9.50 x	—
—	CH	44.00 x	63.00 x	— x	39.00 x	—	—	U04A	44.45 x	63.50 x	— x	9.52 x	—
8006	V	44.00 x	64.00 x	— x	9.00 x	—	6065	CH	44.45 x	63.50 x	— x	9.53 x	—
56045	U001	44.00 x	64.00 x	— x	10.00 x	—	6172	CH	44.45 x	63.50 x	— x	14.29 x	—
56046	U002	44.00 x	64.00 x	— x	10.00 x	—	56076	U04A	44.45 x	63.50 x	— x	15.87 x	—
50953	U002	44.00 x	66.00 x	— x	11.00 x	—	6454	CH	44.45 x	63.50 x	— x	27.50 x	—
50953	U002	44.00 x	66.00 x	— x	11.00 x	—	6029	CH	44.45 x	63.50 x	— x	28.58 x	—
56047	U001	44.00 x	68.00 x	— x	12.00 x	—	—	CH	44.45 x	64.00 x	— x	36.50 x	—
56048	U002	44.00 x	68.00 x	— x	12.00 x	—	6264	CH	44.45 x	64.00 x	— x	47.00 x	—
56049	U002	44.00 x	69.00 x	— x	10.00 x	—	56068	U019	44.45 x	66.68 x	— x	11.11 x	—
56050	U001	44.00 x	69.00 x	— x	12.00 x	—	—	U04A	44.45 x	69.85 x	— x	6.35 x	—
56051	U002	44.00 x	69.00 x	— x	12.00 x	—	—	U04A	44.45 x	69.85 x	— x	12.70 x	—
56052	U001	44.00 x	70.00 x	— x	12.00 x	—	6394	CH	44.45 x	69.85 x	— x	25.00 x	—
56053	U002	44.00 x	70.00 x	— x	12.00 x	—	—	CH	44.45 x	69.85 x	— x	63.00 x	—
56054	U002	44.00 x	75.00 x	— x	12.00 x	—	50722	U037	44.45 x	69.95 x	— x	17.46 x	11.90
56055	U001	44.00 x	80.00 x	— x	12.00 x	—	52633	UL	44.50 x	52.50 x	— x	6.50 x	5.00
56056	U002	44.00 x	80.00 x	— x	12.00 x	—	56069	U001	44.50 x	53.00 x	— x	6.00 x	—
3301	C	44.00 x	82.50 x	4.00 x	15.50 x	—	56070	U004	44.50 x	53.50 x	— x	5.00 x	—
51983	U002	44.30 x	54.20 x	— x	6.80 x	—	56071	U004	44.50 x	53.98 x	— x	6.35 x	—
52915	U	44.30 x	57.00 x	— x	6.35 x	—	59418	UL	44.50 x	54.00 x	— x	4.00 x	6.50
52404	U031	44.40 x	52.00 x	— x	5.30 x	—	59370	UL	44.50 x	54.00 x	— x	5.00 x	6.50
50931	U	44.40 x	53.15 x	— x	4.80 x	—	52013	UL	44.50 x	54.00 x	— x	6.50 x	—
59389	UL	44.40 x	53.17 x	— x	5.50 x	7.00	52013	UL	44.50 x	54.00 x	— x	6.50 x	—
51094	U	44.40 x	54.00 x	— x	5.00 x	—	52096	U04A	44.50 x	54.00 x	— x	9.00 x	—
50173	U002	44.40 x	59.50 x	— x	7.70 x	—	51951	U020	44.50 x	54.50 x	— x	4.70 x	—
52679	U029	44.44 x	66.70 x	— x	13.60 x	—	51106	U	44.50 x	55.00 x	— x	5.00 x	—
52679	U029	44.44 x	66.70 x	— x	13.60 x	—	51658	U	44.50 x	56.50 x	— x	7.50 x	—
52886	UL	44.45 x	52.38 x	— x	5.15 x	—	56072	U001	44.50 x	56.50 x	— x	8.00 x	—
56057	U002	44.45 x	52.39 x	— x	4.76 x	—	56073	U003	44.50 x	57.00 x	— x	7.50 x	—
6459	CH	44.45 x	53.97 x	— x	— x	—	56074	U004	44.50 x	57.00 x	— x	10.50 x	—
56058	U04A	44.45 x	53.97 x	— x	7.94 x	—	—	CH	44.50 x	57.00 x	— x	30.00 x	—
55651	U004	44.45 x	53.97 x	— x	9.52 x	—	56075	U006	44.50 x	58.00 x	— x	10.00 x	—
53305	U	44.45 x	53.97 x	— x	10.32 x	—	50940	U	44.50 x	61.50 x	— x	12.50 x	10.50
—	U04A	44.45 x	53.98 x	— x	4.76 x	—	F7505	W	44.50 x	63.50 x	— x	6.00 x	5.50
51710	U031	44.45 x	53.98 x	— x	6.35 x	—	56077	U002	44.50 x	63.50 x	— x	15.08 x	—
56059	U002	44.45 x	57.15 x	— x	4.76 x	—	56078	U031	44.50 x	65.00 x	— x	9.50 x	—
F4509	W	44.45 x	57.15 x	— x	5.00 x	3.50	56079	U001	44.50 x	68.00 x	— x	11.50 x	—
8094	V	44.45 x	57.15 x	— x	6.35 x	—	—	CH	44.50 x	70.00 x	— x	36.50 x	—
8094	V	44.45 x	57.15 x	— x	6.35 x	—	—	CH	44.50 x	70.00 x	— x	63.50 x	—
52720	U	44.45 x	57.15 x	— x	6.36 x	—	52715	U	44.60 x	54.00 x	— x	9.50 x	—
51988	U	44.45 x	57.15 x	— x	7.93 x	—	8188	V	44.64 x	60.12 x	— x	6.35 x	—
56060	U008	44.45 x	57.15 x	— x	7.94 x	—	6156	CH	44.64 x	60.12 x	— x	38.00 x	—
53346	U001	44.45 x	57.15 x	— x	9.00 x	—	6349	CH	44.70 x	55.00 x	— x	23.00 x	—
53405	U	44.45 x	57.15 x	— x	9.52 x	—	50256	U002	44.70 x	59.30 x	— x	8.00 x	—
50108	U004	44.45 x	57.15 x	— x	9.52 x	—	51359	U026	44.70 x	120.00 x	— x	27.00 x	—
56061	U002	44.45 x	57.15 x	— x	9.53 x	—	53110	U031	45.00 x	50.00 x	— x	8.00 x	—
56062	U006	44.45 x	57.15 x	— x	9.53 x	—	56080	U031	45.00 x	51.00 x	— x	8.00 x	—
51795	U04A	44.45 x	57.15 x	— x	9.53 x	—	56081	U001	45.00 x	52.00 x	— x	8.00 x	—
6136	CH	44.45 x	57.15 x	— x	10.32 x	—	56082	U002	45.00 x	52.00 x	— x	8.00 x	—
51604	U	44.45 x	57.15 x	— x	10.60 x	—	56084	U002	45.00 x	52.00 x	— x	8.00 x	—
56063	U004	44.45 x	57.15 x	— x	10.60 x	—	56083	U007	45.00 x	52.00 x	— x	8.00 x	—
—	CH	44.45 x	57.15 x	— x	25.40 x	—	56085	U005	45.00 x	52.00 x	— x	10.00 x	—
6032	CH	44.45 x	57.15 x	— x	25.40 x	—	56086	U006	45.00 x	52.00 x	— x	10.00 x	—
6204	CH	44.45 x	57.50 x	— x	16.00 x	—	50372	U077	45.00 x	52.50 x	— x	10.00 x	—
—	CH	44.45 x	57.50 x	— x	28.00 x	—	59292	UL	45.00 x	53.00 x	— x	5.00 x	8.00
56064	U005	44.45 x	58.00 x	— x	10.00 x	—	59273	UL	45.00 x	53.00 x	— x	6.00 x	8.00
6216	CH	44.45 x	60.32 x	— x	31.75 x	—	56087	U005	45.00 x	53.00 x	— x	10.00 x	—
56065	U002	44.45 x	60.33 x	— x	6.35 x	—	56088	U006	45.00 x	53.00 x	— x	10.00 x	—
—	U04A	44.45 x	60.33 x	— x	7.93 x	—	51765	U	45.00 x	53.00 x	— x	11.00 x	—
—	U04A	44.45 x	60.33 x	— x	12.70 x	—	51765	U004	45.00 x	53.00 x	— x	11.00 x	—
—	CH	44.45 x	60.33 x	— x	38.00 x	—	56089	U005	45.00 x	53.00 x	— x	11.00 x	—
8413	V	44.45 x	60.45 x	— x	6.35 x	—	56090	U005	45.00 x	53.00 x	— x	12.00 x	—
52352	U	44.45 x	60.45 x	— x	38.10 x	—	56091	U006	45.00 x	53.00 x	— x	12.00 x	—
6091	CH	44.45 x	60.45 x	— x	38.10 x	—	56092	U031	45.00 x	53.00 x	— x	12.00 x	—
6091	CH	44.45 x	60.45 x	— x	38.10 x	—	53535	U080	45.00 x	53.50 x	— x	5.50 x	—
56066	U019	44.45 x	61.91 x	— x	12.70 x	—	56093	U031	45.00 x	54.00 x	— x	5.00 x	—





Cód	Mod	Di x	De x	Esp. x	Ha1 x	Ha2	Cód	Mod	Di x	De x	Esp. x	Ha1 x	Ha2
51385	U	45.00 x	54.00 x	— x	7.00 x	—	6100	CH	45.00 x	61.00 x	— x	29.00 x	—
51385	U004	45.00 x	54.00 x	— x	7.00 x	—	6100	CH	45.00 x	61.00 x	— x	29.00 x	—
56093	U001	45.00 x	54.00 x	— x	9.50 x	—	8197	V	45.00 x	62.00 x	— x	7.00 x	—
53513	U	45.00 x	55.00 x	— x	5.00 x	—	8297	V	45.00 x	62.00 x	— x	8.00 x	—
51829	U049	45.00 x	55.00 x	— x	5.00 x	—	8297	V	45.00 x	62.00 x	— x	8.00 x	—
56094	U002	45.00 x	55.00 x	— x	6.00 x	—	51522	U	45.00 x	62.00 x	— x	12.00 x	—
50824	U004	45.00 x	55.00 x	— x	6.00 x	—	56109	U001	45.00 x	62.00 x	— x	12.00 x	—
51151	U04A	45.00 x	55.00 x	— x	6.00 x	—	50523	U053	45.00 x	62.00 x	— x	12.00 x	—
51151	U04A	45.00 x	55.00 x	— x	6.00 x	—	6380	CH	45.00 x	62.00 x	— x	16.00 x	—
51648	U	45.00 x	55.00 x	— x	7.00 x	—	59309	U007	45.00 x	62.50 x	— x	6.30 x	9.80
51464	U005	45.00 x	55.00 x	— x	7.00 x	—	F4117	W	45.00 x	63.00 x	— x	8.50 x	8.00
51464	U005	45.00 x	55.00 x	— x	7.00 x	—	56110	U001	45.00 x	63.00 x	— x	10.00 x	—
56095	U008	45.00 x	55.00 x	— x	7.00 x	—	50461	U002	45.00 x	63.00 x	— x	10.00 x	—
59291	U006	45.00 x	55.00 x	— x	7.30 x	—	50985	U004	45.00 x	63.00 x	— x	10.00 x	—
56096	U006	45.00 x	55.00 x	— x	7.50 x	—	50985	U004	45.00 x	63.00 x	— x	10.00 x	—
56097	U002	45.00 x	55.00 x	— x	8.00 x	—	51025	U	45.00 x	63.00 x	— x	12.00 x	—
52415	U004	45.00 x	55.00 x	— x	8.00 x	—	51343	U	45.00 x	63.00 x	— x	12.00 x	—
56098	U005	45.00 x	55.00 x	— x	8.00 x	—	51025	U002	45.00 x	63.00 x	— x	12.00 x	—
8339	V	45.00 x	55.00 x	— x	9.00 x	—	56112	U004	45.00 x	63.00 x	— x	12.00 x	—
51968	U006	45.00 x	55.00 x	— x	10.00 x	—	51754	U041	45.00 x	63.00 x	— x	12.00 x	—
50944	U027	45.00 x	55.00 x	— x	10.00 x	—	51330	U	45.00 x	65.00 x	— x	10.00 x	—
50911	U031	45.00 x	55.00 x	— x	10.00 x	—	56113	U001	45.00 x	65.00 x	— x	10.00 x	—
50911	U031	45.00 x	55.00 x	— x	10.00 x	—	50119	U002	45.00 x	65.00 x	— x	10.00 x	—
52739	U04A	45.00 x	55.00 x	— x	10.00 x	—	50119	U002	45.00 x	65.00 x	— x	10.00 x	—
52739	U04A	45.00 x	55.00 x	— x	10.00 x	—	52494	U004	45.00 x	65.00 x	— x	10.00 x	—
52682	U04A	45.00 x	55.00 x	— x	10.00 x	—	52494	U004	45.00 x	65.00 x	— x	10.00 x	—
51779	U04A	45.00 x	55.00 x	— x	11.00 x	—	52494	U004	45.00 x	65.00 x	— x	10.00 x	—
51779	U04A	45.00 x	55.00 x	— x	11.00 x	—	51347	U019	45.00 x	65.00 x	— x	10.00 x	—
52035	U001	45.00 x	56.00 x	— x	6.00 x	—	56114	U019	45.00 x	65.00 x	— x	10.00 x	—
52035	U001	45.00 x	56.00 x	— x	6.00 x	—	56115	U031	45.00 x	65.00 x	— x	10.00 x	—
52541	U004	45.00 x	56.00 x	— x	7.00 x	—	52704	U004	45.00 x	65.00 x	— x	12.00 x	—
53022	U04A	45.00 x	56.00 x	— x	7.00 x	—	56116	U004	45.00 x	65.00 x	— x	12.00 x	—
52358	U031	45.00 x	56.00 x	— x	10.00 x	—	52411	U002	45.00 x	65.00 x	— x	13.00 x	—
52358	U04A	45.00 x	56.00 x	— x	10.00 x	—	6382	CH	45.00 x	65.00 x	— x	15.00 x	—
59288	U001	45.00 x	57.00 x	— x	6.00 x	—	56117	U001	45.00 x	65.00 x	— x	18.00 x	—
56098	U002	45.00 x	57.00 x	— x	6.00 x	—	56118	U002	45.00 x	65.00 x	— x	18.00 x	—
56099	U002	45.00 x	57.00 x	— x	7.00 x	—	—	CH	45.00 x	65.00 x	— x	35.50 x	—
56100	U007	45.00 x	57.00 x	— x	7.00 x	—	56119	U001	45.00 x	66.50 x	— x	12.00 x	—
51719	U	45.00 x	57.00 x	— x	8.00 x	7.00	56120	U001	45.00 x	67.00 x	— x	13.00 x	—
50081	U003	45.00 x	57.00 x	— x	8.00 x	—	56121	U002	45.00 x	67.00 x	— x	13.00 x	—
56101	U002	45.00 x	57.00 x	— x	12.00 x	—	56122	U001	45.00 x	69.00 x	— x	12.00 x	—
52760	U002	45.00 x	58.00 x	— x	6.00 x	—	56123	U002	45.00 x	69.00 x	— x	12.00 x	—
56102	U001	45.00 x	58.00 x	— x	6.50 x	—	56124	U001	45.00 x	70.00 x	— x	8.00 x	—
50788	U	45.00 x	58.00 x	— x	10.00 x	—	56125	U002	45.00 x	70.00 x	— x	8.00 x	—
56103	U004	45.00 x	58.00 x	— x	10.00 x	—	56126	U001	45.00 x	70.00 x	— x	12.00 x	—
50583	U001	45.00 x	58.00 x	— x	11.80 x	—	56127	U002	45.00 x	70.00 x	— x	12.00 x	—
51318	U	45.00 x	60.00 x	— x	6.35 x	—	53502	U	45.00 x	70.00 x	— x	16.00 x	—
51649	U002	45.00 x	60.00 x	— x	7.00 x	—	56128	U001	45.00 x	75.00 x	— x	15.00 x	—
50426	U002	45.00 x	60.00 x	— x	7.50 x	—	56129	U002	45.00 x	75.00 x	— x	15.00 x	—
56104	U005	45.00 x	60.00 x	— x	8.00 x	—	56130	U001	45.00 x	85.00 x	— x	15.00 x	—
8420	V	45.00 x	60.00 x	— x	8.00 x	—	3454	C	45.00 x	101.00 x	3.20 x	21.00 x	—
50670	U002	45.00 x	60.00 x	— x	10.00 x	—	59415	UL	45.50 x	54.00 x	— x	6.00 x	—
51806	U002	45.00 x	60.00 x	— x	10.00 x	—	56131	U002	45.50 x	55.50 x	— x	10.00 x	—
51806	U002	45.00 x	60.00 x	— x	10.00 x	—	51455	U	45.50 x	59.50 x	— x	8.00 x	—
56106	U004	45.00 x	60.00 x	— x	10.00 x	—	6421	CH	45.50 x	60.00 x	— x	30.00 x	—
56107	U006	45.00 x	60.00 x	— x	10.00 x	—	50927	U	45.50 x	61.50 x	— x	7.50 x	—
50534	U040	45.00 x	60.00 x	— x	10.00 x	—	50613	U002	45.80 x	68.80 x	— x	10.00 x	—
50534	U040	45.00 x	60.00 x	— x	10.00 x	—	50495	U001	46.00 x	53.00 x	— x	9.00 x	—
50878	U041	45.00 x	60.00 x	— x	10.00 x	—	56132	U008	46.00 x	53.50 x	— x	8.00 x	—
50878	U04A	45.00 x	60.00 x	— x	10.00 x	—	56133	U007	46.00 x	54.00 x	— x	7.50 x	—
52879	U041	45.00 x	60.00 x	— x	10.40 x	—	51910	U004	46.00 x	54.00 x	— x	8.00 x	—
50892	U002	45.00 x	60.00 x	— x	10.50 x	—	56134	U007	46.00 x	54.00 x	— x	8.00 x	—
56108	U006	45.00 x	60.00 x	— x	20.00 x	—	51628	U054	46.00 x	54.00 x	— x	8.00 x	—
6449	CH	45.00 x	60.00 x	— x	28.00 x	—	51628	U054	46.00 x	54.00 x	— x	8.00 x	4.00
55719	U	45.00 x	60.60 x	— x	10.00 x	—	56135	U006	46.00 x	54.00 x	— x	10.00 x	—
55719	U001	45.00 x	60.60 x	— x	10.00 x	—	56136	U005	46.00 x	54.00 x	— x	12.00 x	—
8135	V	45.00 x	61.00 x	— x	29.00 x	—	56137	U006	46.00 x	54.00 x	— x	12.00 x	—



Cód	Mod	Di x	De x	Esp. x	Ha1 x	Ha2	Cód	Mod	Di x	De x	Esp. x	Ha1 x	Ha2
51715	U031	46.00 x	54.50 x	— x	8.30 x	7.40	52250	U019	47.50 x	58.00 x	— x	5.00 x	—
52541	U004	46.00 x	56.00 x	— x	7.00 x	—	56171	U005	47.50 x	58.00 x	— x	9.00 x	—
56138	U004	46.00 x	56.00 x	— x	7.00 x	—	56172	U006	47.50 x	58.00 x	— x	9.00 x	—
52329	U031	46.00 x	56.00 x	— x	10.00 x	—	56173	U002	47.50 x	60.00 x	— x	9.00 x	—
51158	U	46.00 x	57.00 x	— x	6.40 x	—	51399	U001	47.50 x	62.50 x	— x	8.00 x	—
51683	U	46.00 x	58.00 x	— x	8.00 x	—	51400	U046	47.50 x	62.50 x	— x	8.00 x	9.50
51113	U007	46.00 x	58.00 x	— x	8.00 x	7.00	56174	U	47.50 x	63.50 x	— x	7.50 x	9.00
51717	U007	46.00 x	58.00 x	— x	10.00 x	—	50353	U021	47.50 x	63.50 x	— x	9.00 x	7.50
—	CH	46.00 x	58.00 x	— x	48.00 x	—	—	CH	47.50 x	63.50 x	— x	23.00 x	—
56139	U001	46.00 x	59.00 x	— x	12.00 x	—	56175	U003	47.50 x	65.00 x	— x	9.00 x	—
56140	U002	46.00 x	59.00 x	— x	12.00 x	—	51564	U004	47.50 x	67.00 x	— x	9.50 x	—
56141	U001	46.00 x	59.00 x	— x	13.00 x	—	52423	U	47.50 x	67.20 x	— x	5.00 x	—
56142	U002	46.00 x	59.00 x	— x	13.00 x	—	56176	U001	47.50 x	75.30 x	— x	12.50 x	—
—	CH	46.00 x	59.00 x	— x	36.00 x	—	56177	U002	47.50 x	75.30 x	— x	12.50 x	—
51041	U	46.00 x	60.00 x	— x	6.00 x	—	6398	CH	47.50 x	79.00 x	— x	50.00 x	—
56143	U002	46.00 x	61.00 x	— x	8.50 x	—	3303	C	47.50 x	115.00 x	— x	17.00 x	—
—	CH	46.00 x	62.00 x	— x	38.00 x	—	51157	U	47.60 x	54.00 x	— x	4.50 x	—
8004	V	46.00 x	65.00 x	— x	9.00 x	—	51157	U031	47.60 x	54.00 x	— x	4.50 x	—
56144	U001	46.00 x	66.00 x	— x	10.00 x	—	56178	U006	47.60 x	56.00 x	— x	10.00 x	—
56145	U002	46.00 x	66.00 x	— x	10.00 x	—	59336	U002	47.60 x	57.15 x	— x	4.76 x	—
56146	U001	46.00 x	66.00 x	— x	12.00 x	—	8211	V	47.60 x	60.30 x	— x	6.35 x	—
56147	U001	46.00 x	68.00 x	— x	12.00 x	—	50598	U002	47.60 x	62.60 x	— x	8.30 x	—
56148	U002	46.00 x	68.00 x	— x	12.00 x	—	50598	U002	47.60 x	62.60 x	— x	8.30 x	—
52613	U002	46.00 x	70.00 x	— x	12.00 x	—	50274	U062	47.60 x	63.00 x	— x	9.50 x	—
56149	U002	46.00 x	70.00 x	— x	12.00 x	—	6167	CH	47.60 x	79.20 x	— x	40.00 x	—
56150	U019	46.00 x	70.00 x	— x	12.00 x	—	8093	V	47.62 x	59.53 x	— x	5.56 x	—
—	CH	46.00 x	70.00 x	— x	65.00 x	—	8123	V	47.62 x	63.50 x	— x	7.00 x	—
56151	U002	46.00 x	73.00 x	— x	15.00 x	—	50595	U002	47.62 x	63.50 x	— x	8.73 x	—
3526	C	46.00 x	77.00 x	5.00 x	37.00 x	—	6198	CH	47.62 x	63.50 x	— x	12.70 x	—
50337	U002	46.02 x	69.95 x	— x	12.70 x	—	8149	V	47.62 x	69.95 x	— x	9.52 x	—
56152	U002	46.04 x	57.15 x	— x	6.35 x	—	6109	CH	47.62 x	69.95 x	— x	20.00 x	—
52445	U002	46.04 x	58.74 x	— x	4.76 x	—	3189	C	47.62 x	114.30 x	3.50 x	17.46 x	—
56153	U019	46.04 x	68.26 x	— x	9.53 x	—	56179	U005	47.63 x	55.96 x	— x	9.92 x	—
6331	CH	46.50 x	60.00 x	— x	39.00 x	—	56180	U002	47.63 x	57.15 x	— x	4.76 x	—
56154	U002	47.00 x	54.00 x	— x	5.00 x	—	56193	U04A	47.63 x	57.15 x	— x	9.52 x	—
51721	U031	47.00 x	55.00 x	— x	7.80 x	—	6040	CH	47.63 x	59.53 x	— x	25.40 x	—
56155	U007	47.00 x	55.00 x	— x	8.00 x	—	56181	U007	47.63 x	59.93 x	— x	6.75 x	—
56156	U008	47.00 x	55.00 x	— x	8.00 x	—	56183	U001	47.63 x	60.33 x	— x	6.35 x	—
—	CH	47.00 x	55.00 x	— x	36.00 x	—	52628	U007	47.63 x	60.33 x	— x	6.35 x	—
56157	U007	47.00 x	57.00 x	— x	12.00 x	—	56184	U007	47.63 x	60.33 x	— x	6.35 x	—
56158	U008	47.00 x	57.00 x	— x	12.00 x	—	56185	U008	47.63 x	60.33 x	— x	6.35 x	—
59297	U007	47.00 x	58.00 x	— x	4.80 x	5.90	56186	U04A	47.63 x	60.33 x	— x	9.52 x	—
50332	U049	47.00 x	58.00 x	— x	5.00 x	—	56187	U002	47.63 x	61.91 x	— x	7.54 x	—
51185	U	47.00 x	58.00 x	— x	6.00 x	5.00	56188	U019	47.63 x	63.50 x	— x	7.94 x	—
56159	U002	47.00 x	59.00 x	— x	10.00 x	—	51770	U04A	47.63 x	63.50 x	— x	7.94 x	—
56160	U002	47.00 x	62.00 x	— x	7.50 x	—	56189	U002	47.63 x	63.50 x	— x	8.33 x	—
—	U04A	47.00 x	62.00 x	— x	11.00 x	—	56190	U005	47.63 x	63.50 x	— x	9.53 x	—
51382	U031	47.00 x	63.00 x	— x	8.00 x	—	56191	U006	47.63 x	63.50 x	— x	9.53 x	—
—	CH	47.00 x	63.00 x	— x	38.00 x	—	56192	U004	47.63 x	63.50 x	— x	9.92 x	—
51528	U003	47.00 x	63.30 x	— x	12.00 x	—	—	U04A	47.63 x	63.50 x	— x	12.70 x	—
56161	U001	47.00 x	64.00 x	— x	12.00 x	—	6054	CH	47.63 x	63.50 x	— x	19.05 x	—
56162	U002	47.00 x	64.00 x	— x	12.00 x	—	6194	CH	47.63 x	79.20 x	— x	47.00 x	—
56163	U001	47.00 x	64.00 x	— x	13.00 x	—	52280	U	47.80 x	63.00 x	— x	8.00 x	—
56164	U002	47.00 x	64.00 x	— x	13.00 x	—	56194	U007	47.87 x	60.28 x	— x	7.40 x	—
50236	U002	47.00 x	65.00 x	— x	10.00 x	—	56195	U008	47.87 x	60.28 x	— x	7.40 x	—
50236	U002	47.00 x	65.00 x	— x	10.00 x	—	51827	U	48.00 x	54.00 x	— x	4.50 x	—
56165	U002	47.00 x	66.00 x	— x	12.00 x	—	8406	V	48.00 x	54.00 x	— x	4.50 x	—
51452	U	47.00 x	67.00 x	— x	10.00 x	—	56196	U001	48.00 x	54.50 x	— x	6.00 x	—
—	CH	47.00 x	68.00 x	— x	50.00 x	—	56197	U002	48.00 x	54.50 x	— x	6.00 x	—
56166	U001	47.00 x	84.00 x	— x	17.50 x	—	51384	U	48.00 x	56.00 x	— x	5.00 x	—
56167	U002	47.00 x	84.00 x	— x	17.50 x	—	50794	U	48.00 x	56.00 x	— x	7.50 x	—
3181	C001	47.00 x	115.00 x	3.50 x	16.00 x	—	56198	U005	48.00 x	56.00 x	— x	12.00 x	—
52425	U	47.30 x	57.50 x	— x	5.50 x	—	56199	U006	48.00 x	56.00 x	— x	12.00 x	—
50981	U002	47.30 x	59.50 x	— x	8.00 x	—	56200	U004	48.00 x	58.00 x	— x	10.00 x	—
56168	U001	47.43 x	58.44 x	— x	5.08 x	—	56201	U001	48.00 x	60.00 x	— x	6.00 x	—
56169	U002	47.43 x	58.44 x	— x	5.08 x	—	56203	U002	48.00 x	60.00 x	— x	6.00 x	—
56170	U005	47.50 x	55.50 x	— x	10.00 x	—	56204	U001	48.00 x	60.00 x	— x	9.00 x	—



Cód	Mod	Di x	De x	Esp. x	Ha1 x	Ha2	Cód	Mod	Di x	De x	Esp. x	Ha1 x	Ha2
56205	U002	48.00 x	60.00 x	— x	9.00 x	—	56238	U019	49.21 x	69.85 x	— x	9.53 x	—
56206	U007	48.00 x	60.00 x	— x	9.00 x	—	6021	CH	49.21 x	69.85 x	— x	26.99 x	—
56207	U008	48.00 x	60.00 x	— x	9.00 x	—	6437	CH	49.30 x	68.30 x	— x	76.20 x	—
56208	U008	48.00 x	60.00 x	— x	9.00 x	—	50150	U046	49.30 x	68.50 x	— x	12.00 x	—
51216	U031	48.00 x	60.00 x	— x	10.00 x	—	56239	U001	49.50 x	58.00 x	— x	8.00 x	—
52952	U002	48.00 x	61.00 x	— x	5.00 x	—	56240	U002	49.50 x	58.00 x	— x	8.00 x	—
56209	U002	48.00 x	62.00 x	— x	8.00 x	—	56241	U003	49.50 x	62.00 x	— x	6.00 x	—
51619	U002	48.00 x	63.00 x	— x	8.00 x	—	52387	U	49.50 x	65.70 x	— x	13.50 x	—
56210	U002	48.00 x	63.00 x	— x	8.00 x	—	52794	U	49.50 x	69.50 x	— x	12.30 x	—
59318	U001	48.00 x	63.00 x	— x	10.00 x	—	52389	U	49.80 x	60.50 x	— x	9.60 x	—
—	U04A	48.00 x	63.00 x	— x	12.00 x	—	55714	U026	49.80 x	70.00 x	— x	17.10 x	—
6170	CH	48.00 x	63.00 x	— x	13.00 x	—	56243	U001	50.00 x	56.00 x	— x	8.00 x	—
6214	CH	48.00 x	63.00 x	— x	13.00 x	—	56244	U002	50.00 x	56.00 x	— x	8.00 x	—
—	CH	48.00 x	64.00 x	— x	38.00 x	—	56245	U007	50.00 x	57.00 x	— x	8.00 x	—
50063	U013	48.00 x	65.00 x	— x	9.00 x	—	56246	U005	50.00 x	57.00 x	— x	10.00 x	—
56211	U001	48.00 x	65.00 x	— x	10.00 x	—	56247	U006	50.00 x	57.00 x	— x	10.00 x	—
56212	U002	48.00 x	65.00 x	— x	10.00 x	—	53538	U006	50.00 x	57.20 x	— x	6.00 x	—
—	CH	48.00 x	65.00 x	— x	40.00 x	—	59326	UL	50.00 x	58.00 x	— x	4.00 x	6.00
56213	U001	48.00 x	68.00 x	— x	10.00 x	—	53152	UL	50.00 x	58.00 x	— x	4.50 x	6.35
50319	U003	48.00 x	68.00 x	— x	10.00 x	—	53152	UL	50.00 x	58.00 x	— x	4.50 x	6.35
52536	U003	48.00 x	68.00 x	— x	10.00 x	—	56248	U005	50.00 x	58.00 x	— x	8.00 x	—
56214	U019	48.00 x	68.00 x	— x	10.00 x	—	56249	U006	50.00 x	58.00 x	— x	8.00 x	—
51914	U	48.00 x	68.00 x	— x	12.00 x	—	52158	U051	50.00 x	58.00 x	— x	8.00 x	—
56215	U004	48.00 x	68.00 x	— x	12.00 x	—	52158	U051	50.00 x	58.00 x	— x	8.00 x	—
56220	U001	48.00 x	68.00 x	— x	14.00 x	—	56250	U002	50.00 x	58.00 x	— x	10.00 x	—
56216	U001	48.00 x	68.00 x	— x	14.00 x	—	51912	U004	50.00 x	58.60 x	— x	7.50 x	—
56217	U002	48.00 x	68.00 x	— x	14.00 x	—	55569	U011	50.00 x	59.00 x	— x	8.00 x	—
56218	U001	48.00 x	68.00 x	— x	18.00 x	—	6348	CH	50.00 x	59.80 x	— x	15.80 x	—
56219	U002	48.00 x	68.00 x	— x	18.00 x	—	53150	U002	50.00 x	60.00 x	— x	5.00 x	—
56221	U001	48.00 x	70.00 x	— x	10.00 x	—	53150	U002	50.00 x	60.00 x	— x	5.00 x	—
56222	U002	48.00 x	70.00 x	— x	10.00 x	—	50141	U017	50.00 x	60.00 x	— x	5.00 x	—
8298	V	48.00 x	70.00 x	— x	14.00 x	11.00	59362	UL	50.00 x	60.00 x	— x	5.00 x	7.00
56223	U001	48.00 x	72.00 x	— x	12.00 x	—	51394	U04A	50.00 x	60.00 x	— x	6.00 x	—
56224	U002	48.00 x	72.00 x	— x	12.00 x	—	52478	U	50.00 x	60.00 x	— x	6.35 x	—
56225	U001	48.00 x	75.00 x	— x	12.00 x	—	52478	U002	50.00 x	60.00 x	— x	6.35 x	—
56226	U002	48.00 x	75.00 x	— x	12.00 x	—	52023	U	50.00 x	60.00 x	— x	6.50 x	—
F5936	J	48.00 x	75.50 x	— x	20.00 x	24.00	51010	U	50.00 x	60.00 x	— x	7.00 x	5.00
56227	U001	48.00 x	78.00 x	— x	15.00 x	—	52645	U	50.00 x	60.00 x	— x	7.00 x	—
56228	U002	48.00 x	78.00 x	— x	15.00 x	—	52568	U	50.00 x	60.00 x	— x	7.00 x	—
3448	C	48.00 x	81.00 x	3.80 x	16.10 x	—	51958	U001	50.00 x	60.00 x	— x	7.00 x	—
3103	C	48.00 x	181.00 x	7.00 x	25.00 x	—	56252	U005	50.00 x	60.00 x	— x	7.00 x	—
56229	U001	48.50 x	58.50 x	— x	9.00 x	—	55568	U008	50.00 x	60.00 x	— x	7.00 x	—
52037	U	49.00 x	52.50 x	— x	8.50 x	7.50	52651	U019	50.00 x	60.00 x	— x	7.00 x	—
56230	U001	49.00 x	60.00 x	— x	5.50 x	—	59400	UL	50.00 x	60.00 x	— x	7.00 x	12.00
51498	U004	49.00 x	62.00 x	— x	7.00 x	—	52568	UL	50.00 x	60.00 x	— x	7.00 x	5.50
52367	U003	49.00 x	63.00 x	— x	8.00 x	—	52410	U	50.00 x	60.00 x	— x	7.50 x	—
8202	V	49.00 x	64.00 x	— x	5.00 x	—	52410	U004	50.00 x	60.00 x	— x	7.50 x	—
52988	U	49.00 x	65.00 x	— x	8.00 x	—	53388	U004	50.00 x	60.00 x	— x	8.50 x	—
52988	U	49.00 x	65.00 x	— x	8.00 x	—	56253	U002	50.00 x	60.00 x	— x	9.00 x	—
56231	U002	49.00 x	65.00 x	— x	8.00 x	—	52268	U003	50.00 x	60.00 x	— x	9.00 x	—
56232	U008	49.00 x	65.00 x	— x	12.00 x	—	—	U04A	50.00 x	60.00 x	— x	9.00 x	—
51402	U065	49.00 x	65.00 x	— x	12.00 x	—	56254	U04A	50.00 x	60.00 x	— x	9.00 x	—
—	CH	49.00 x	65.00 x	— x	38.00 x	—	56257	U007	50.00 x	60.00 x	— x	9.30 x	10.30
50246	U003	49.00 x	67.00 x	— x	9.00 x	—	52306	U003	50.00 x	60.00 x	— x	9.50 x	—
50246	U026	49.00 x	67.00 x	— x	9.00 x	—	3270	C	50.00 x	60.00 x	— x	10.00 x	—
8005	V	49.00 x	70.00 x	— x	8.00 x	—	56255	U001	50.00 x	60.00 x	— x	10.00 x	—
56233	U004	49.00 x	70.00 x	— x	12.00 x	—	50144	U004	50.00 x	60.00 x	— x	10.00 x	—
50888	U	49.00 x	70.00 x	— x	15.00 x	13.00	56256	U014	50.00 x	60.00 x	— x	10.00 x	—
56234	U003	49.00 x	75.00 x	— x	11.00 x	—	56258	U008	50.00 x	60.00 x	— x	10.50 x	—
56235	U	49.00 x	122.00 x	— x	27.00 x	—	50189	U008	50.00 x	60.00 x	— x	11.00 x	9.00
51355	U026	49.20 x	120.00 x	— x	27.00 x	—	50647	U004	50.00 x	60.00 x	— x	12.00 x	—
50444	U002	49.21 x	60.32 x	— x	6.35 x	—	56259	U005	50.00 x	60.00 x	— x	12.00 x	—
56236	U002	49.21 x	61.52 x	— x	9.13 x	—	56260	U006	50.00 x	60.00 x	— x	12.00 x	—
51662	U004	49.21 x	61.60 x	— x	9.20 x	—	56261	U007	50.00 x	60.00 x	— x	12.00 x	—
6071	CH	49.21 x	61.91 x	— x	28.57 x	—	56262	U008	50.00 x	60.00 x	— x	12.00 x	—
50520	U006	49.21 x	63.50 x	— x	10.00 x	—	52173	U04A	50.00 x	60.00 x	— x	12.30 x	—
56237	U002	49.21 x	65.88 x	— x	9.13 x	—	6200	CH	50.00 x	60.00 x	— x	17.00 x	—



Cód	Mod	Di x	De x	Esp. x	Ha1 x	Ha2	Cód	Mod	Di x	De x	Esp. x	Ha1 x	Ha2
6200	CH	50.00 x	60.00 x	— x	18.50 x	—	56286	U001	50.00 x	68.00 x	— x	15.00 x	—
56263	U002	50.00 x	61.00 x	— x	5.50 x	—	56287	U002	50.00 x	68.00 x	— x	15.00 x	—
51268	U019	50.00 x	61.00 x	— x	6.00 x	—	50287	U002	50.00 x	69.50 x	— x	10.00 x	—
59319	U002	50.00 x	61.00 x	— x	7.00 x	—	50252	U004	50.00 x	69.50 x	— x	12.00 x	—
55576	U006	50.00 x	61.00 x	— x	7.00 x	—	56288	U004	50.00 x	69.50 x	— x	12.50 x	—
56264	U001	50.00 x	61.00 x	— x	15.00 x	—	56289	U004	50.00 x	69.80 x	— x	14.00 x	—
56265	U002	50.00 x	61.00 x	— x	15.00 x	—	55697	U001	50.00 x	70.00 x	— x	7.00 x	—
56266	U001	50.00 x	62.00 x	— x	6.00 x	—	8264	V	50.00 x	70.00 x	— x	7.00 x	—
56267	U002	50.00 x	62.00 x	— x	6.00 x	—	8264	V	50.00 x	70.00 x	— x	7.00 x	—
50130	U061	50.00 x	62.00 x	— x	6.00 x	—	8348	V	50.00 x	70.00 x	— x	8.20 x	—
56268	U	50.00 x	62.00 x	— x	6.50 x	9.50	51555	U003	50.00 x	70.00 x	— x	10.00 x	—
56269	U007	50.00 x	62.00 x	— x	7.50 x	—	56290	U004	50.00 x	70.00 x	— x	10.00 x	—
56270	U001	50.00 x	62.00 x	— x	9.00 x	—	56291	U019	50.00 x	70.00 x	— x	10.00 x	—
56271	U005	50.00 x	62.00 x	— x	9.00 x	—	56292	U002	50.00 x	70.00 x	— x	11.00 x	—
50042	U077	50.00 x	62.00 x	— x	9.50 x	6.50	51305	U004	50.00 x	70.00 x	— x	11.00 x	—
52112	U012	50.00 x	62.00 x	— x	9.70 x	6.00	52742	U	50.00 x	70.00 x	— x	12.00 x	—
52298	U	50.00 x	62.00 x	— x	10.00 x	—	51039	U004	50.00 x	70.00 x	— x	12.00 x	—
56272	U005	50.00 x	62.00 x	— x	10.00 x	—	51039	U004	50.00 x	70.00 x	— x	12.00 x	—
52298	U011	50.00 x	62.00 x	— x	10.00 x	6.50	56293	U002	50.00 x	70.00 x	— x	14.00 x	—
51080	U	50.00 x	62.50 x	— x	9.50 x	—	56294	U005	50.00 x	70.00 x	— x	14.50 x	—
56273	U001	50.00 x	63.00 x	— x	6.00 x	—	56295	U006	50.00 x	70.00 x	— x	14.50 x	—
56274	U002	50.00 x	63.00 x	— x	6.00 x	—	56296	U003	50.00 x	70.00 x	— x	16.00 x	—
51253	U	50.00 x	63.00 x	— x	6.50 x	—	56297	U001	50.00 x	70.00 x	— x	18.00 x	—
56275	U031	50.00 x	63.00 x	— x	7.00 x	—	56298	U002	50.00 x	70.00 x	— x	18.00 x	—
52378	U032	50.00 x	63.00 x	— x	8.00 x	—	6221	CH	50.00 x	70.00 x	— x	30.00 x	—
51652	U	50.00 x	63.00 x	— x	8.50 x	—	—	CH	50.00 x	70.00 x	— x	46.00 x	—
51753	U006	50.00 x	63.00 x	— x	8.50 x	—	8165	V	50.00 x	71.00 x	— x	7.00 x	—
56276	U008	50.00 x	63.00 x	— x	8.70 x	10.00	56299	U001	50.00 x	71.00 x	— x	12.00 x	—
—	U04A	50.00 x	63.00 x	— x	9.00 x	—	56300	U002	50.00 x	71.00 x	— x	12.00 x	—
50798	U	50.00 x	63.00 x	— x	10.00 x	—	56301	U004	50.00 x	71.00 x	— x	12.00 x	—
—	CH	50.00 x	63.00 x	— x	24.00 x	—	6122	CH	50.00 x	71.00 x	— x	33.00 x	—
51074	U002	50.00 x	64.00 x	— x	10.00 x	—	56302	U001	50.00 x	71.50 x	— x	15.00 x	—
—	CH	50.00 x	64.00 x	— x	30.50 x	—	56303	U002	50.00 x	71.50 x	— x	15.00 x	—
56277	U004	50.00 x	64.50 x	— x	9.50 x	—	51001	U001	50.00 x	72.00 x	— x	8.00 x	—
8145	V	50.00 x	65.00 x	— x	5.80 x	—	55599	U001	50.00 x	72.00 x	— x	12.00 x	—
51585	U001	50.00 x	65.00 x	— x	7.00 x	—	56304	U002	50.00 x	72.00 x	— x	12.00 x	—
56278	U002	50.00 x	65.00 x	— x	7.50 x	—	56305	U006	50.00 x	73.00 x	— x	11.00 x	—
56279	U005	50.00 x	65.00 x	— x	8.00 x	—	56306	U001	50.00 x	73.00 x	— x	12.00 x	—
8167	V	50.00 x	65.00 x	— x	9.00 x	—	56307	U002	50.00 x	73.00 x	— x	12.00 x	—
56280	U001	50.00 x	65.00 x	— x	10.00 x	—	56308	U003	50.00 x	73.00 x	— x	12.00 x	—
52134	U002	50.00 x	65.00 x	— x	10.00 x	—	56309	U001	50.00 x	74.00 x	— x	12.00 x	—
52134	U002	50.00 x	65.00 x	— x	10.00 x	—	56310	U002	50.00 x	74.00 x	— x	12.00 x	—
50531	U004	50.00 x	65.00 x	— x	10.00 x	—	56311	U004	50.00 x	74.00 x	— x	15.00 x	—
52251	U006	50.00 x	65.00 x	— x	10.00 x	—	53446	U	50.00 x	75.00 x	— x	8.00 x	—
50176	U031	50.00 x	65.00 x	— x	10.00 x	—	F6118	J	50.00 x	75.00 x	— x	11.50 x	20.00
50176	U031	50.00 x	65.00 x	— x	10.00 x	—	50093	U002	50.00 x	75.00 x	— x	12.00 x	—
50847	U040	50.00 x	65.00 x	— x	10.00 x	—	56312	U001	50.00 x	75.00 x	— x	12.50 x	—
56281	U004	50.00 x	65.00 x	— x	12.00 x	—	56313	U002	50.00 x	75.00 x	— x	12.50 x	—
50192	U031	50.00 x	65.00 x	— x	12.00 x	—	8286	V	50.00 x	75.00 x	— x	13.00 x	—
6123	CH	50.00 x	65.00 x	— x	27.00 x	—	56314	U004	50.00 x	75.00 x	— x	15.00 x	—
—	CH	50.00 x	65.00 x	— x	36.50 x	—	56315	U001	50.00 x	75.00 x	— x	16.00 x	—
52095	U047	50.00 x	65.50 x	— x	11.20 x	—	56316	U002	50.00 x	75.00 x	— x	16.00 x	—
F4127	W	50.00 x	66.00 x	— x	5.50 x	5.00	56317	U004	50.00 x	75.00 x	— x	16.00 x	—
8223	V	50.00 x	66.00 x	— x	7.50 x	—	3253	C	50.00 x	76.00 x	5.00 x	15.00 x	—
53467	U001	50.00 x	66.00 x	— x	8.00 x	—	56318	U001	50.00 x	76.00 x	— x	15.00 x	—
56282	U002	50.00 x	66.00 x	— x	8.00 x	—	56319	U002	50.00 x	76.00 x	— x	15.00 x	—
53189	U	50.00 x	66.00 x	— x	9.00 x	—	56320	U001	50.00 x	78.00 x	— x	15.00 x	—
8128	V	50.00 x	66.00 x	— x	9.00 x	—	56321	U002	50.00 x	78.00 x	— x	15.00 x	—
56283	U004	50.00 x	66.00 x	— x	10.00 x	—	56322	U001	50.00 x	80.00 x	— x	10.00 x	—
53189	U008	50.00 x	66.00 x	— x	10.50 x	—	56323	U002	50.00 x	80.00 x	— x	10.00 x	—
6097	CH	50.00 x	66.00 x	— x	29.00 x	—	56324	U002	50.00 x	80.00 x	— x	11.00 x	—
—	CH	50.00 x	66.00 x	— x	33.50 x	—	8224	V	50.00 x	80.00 x	— x	11.00 x	—
—	CH	50.00 x	66.00 x	— x	38.00 x	—	56325	U001	50.00 x	80.00 x	— x	15.00 x	—
8385	V	50.00 x	67.00 x	— x	6.35 x	—	56326	U002	50.00 x	80.00 x	— x	15.00 x	—
56284	U005	50.00 x	67.00 x	— x	9.50 x	—	50329	U001	50.00 x	80.00 x	— x	16.00 x	—
56285	U001	50.00 x	68.00 x	— x	9.00 x	—	56327	U001	50.00 x	80.00 x	— x	25.00 x	—
52058	U04A	50.00 x	68.00 x	— x	10.00 x	—	56328	U002	50.00 x	80.00 x	— x	25.00 x	—





Cód	Mod	Di x	De x	Esp. x	Ha1 x	Ha2	Cód	Mod	Di x	De x	Esp. x	Ha1 x	Ha2
6162	CH	50.00 x	80.00 x	— x	36.50 x	—	50574	U002	50.80 x	63.50 x	— x	9.52 x	—
—	CH	50.00 x	80.00 x	— x	40.50 x	—	50136	U004	50.80 x	63.50 x	— x	9.52 x	—
56329	U001	50.00 x	90.00 x	— x	15.00 x	—	50585	U008	50.80 x	63.50 x	— x	9.52 x	6.00
56330	U002	50.00 x	90.00 x	— x	15.00 x	—	51966	U04A	50.80 x	63.50 x	— x	9.52 x	—
56331	U001	50.00 x	90.00 x	— x	25.00 x	—	53505	U04A	50.80 x	63.50 x	— x	9.52 x	—
56332	U002	50.00 x	90.00 x	— x	25.00 x	—	56354	U006	50.80 x	63.50 x	— x	9.53 x	—
56333	U001	50.00 x	95.00 x	— x	15.00 x	—	51844	U04A	50.80 x	63.50 x	— x	9.53 x	—
56334	U002	50.00 x	95.00 x	— x	15.00 x	—	59330	U04A	50.80 x	63.50 x	— x	9.53 x	—
3267	C	50.00 x	106.00 x	— x	10.00 x	—	50431	U002	50.80 x	63.50 x	— x	11.11 x	—
56335	U001	50.00 x	110.00 x	— x	30.00 x	—	50154	U004	50.80 x	63.50 x	— x	11.11 x	—
56336	U002	50.00 x	110.00 x	— x	30.00 x	—	50154	U004	50.80 x	63.50 x	— x	11.11 x	—
52185	U012	50.30 x	62.00 x	— x	9.50 x	6.00	59279	U-02	50.80 x	63.50 x	— x	12.70 x	—
F11120	W	50.30 x	76.11 x	— x	15.00 x	—	52245	U	50.80 x	63.50 x	— x	19.35 x	—
56337	U005	50.50 x	57.00 x	— x	10.00 x	—	6009	CH	50.80 x	63.50 x	— x	22.23 x	—
56338	U006	50.50 x	57.00 x	— x	10.00 x	—	—	CH	50.80 x	63.50 x	— x	27.00 x	—
56339	U002	50.50 x	60.50 x	— x	5.00 x	—	—	CH	50.80 x	63.50 x	— x	47.00 x	—
8302	V	50.50 x	66.00 x	— x	7.50 x	—	52383	U002	50.80 x	64.00 x	— x	10.00 x	—
52127	U004	50.50 x	66.00 x	— x	8.00 x	—	52383	U04A	50.80 x	64.00 x	— x	10.00 x	—
—	CH	50.50 x	66.50 x	— x	27.50 x	—	56355	U002	50.80 x	65.00 x	— x	7.00 x	—
56340	U002	50.50 x	67.50 x	— x	6.00 x	—	8018	V	50.80 x	66.67 x	— x	6.35 x	—
56341	U019	50.50 x	74.00 x	— x	10.00 x	—	6027	CH	50.80 x	66.68 x	— x	— x	—
8144	V	50.65 x	64.50 x	— x	6.50 x	—	51637	U	50.80 x	66.68 x	— x	7.94 x	—
56342	U031	50.80 x	58.60 x	— x	6.00 x	—	52234	U001	50.80 x	66.68 x	— x	7.94 x	—
56343	U005	50.80 x	58.74 x	— x	13.49 x	—	56356	U002	50.80 x	66.68 x	— x	7.94 x	—
56344	U006	50.80 x	58.74 x	— x	13.49 x	—	—	U04A	50.80 x	66.68 x	— x	12.70 x	—
50708	U005	50.80 x	60.00 x	— x	4.50 x	—	6033	CH	50.80 x	66.68 x	— x	12.70 x	—
50875	U003	50.80 x	60.00 x	— x	5.50 x	—	51199	U002	50.80 x	66.80 x	— x	11.80 x	—
59416	UL	50.80 x	60.00 x	— x	5.50 x	6.50	56357	U004	50.80 x	66.80 x	— x	11.91 x	—
59402	UL	50.80 x	60.00 x	— x	6.00 x	7.00	52086	U079	50.80 x	67.00 x	— x	7.50 x	4.50
51944	U006	50.80 x	60.00 x	— x	7.00 x	—	—	CH	50.80 x	67.47 x	— x	40.00 x	—
59353	UL	50.80 x	60.00 x	— x	7.00 x	—	56358	U002	50.80 x	68.85 x	— x	9.53 x	—
59353	UL	50.80 x	60.00 x	— x	7.00 x	—	56359	U001	50.80 x	69.85 x	— x	9.53 x	—
59353	UL	50.80 x	60.00 x	— x	7.40 x	—	—	U04A	50.80 x	69.85 x	— x	15.87 x	—
55887	U005	50.80 x	60.00 x	— x	10.00 x	—	6067	CH	50.80 x	69.85 x	— x	28.58 x	—
56345	U005	50.80 x	60.00 x	— x	10.00 x	—	6049	CH	50.80 x	69.85 x	— x	33.34 x	—
56346	U006	50.80 x	60.00 x	— x	10.00 x	—	8064	V	50.80 x	69.95 x	— x	6.35 x	—
59349	UL	50.80 x	60.30 x	— x	4.50 x	9.00	8014	V	50.80 x	69.95 x	— x	7.94 x	—
59349	UL	50.80 x	60.30 x	— x	4.50 x	9.00	8104	V	50.80 x	69.95 x	— x	8.00 x	—
52695	U004	50.80 x	60.32 x	— x	9.50 x	—	51260	U004	50.80 x	69.95 x	— x	12.70 x	—
50450	U005	50.80 x	60.32 x	— x	11.91 x	—	56360	U002	50.80 x	72.00 x	— x	4.20 x	—
56347	U031	50.80 x	60.33 x	— x	4.76 x	—	6287	CH	50.80 x	73.01 x	— x	65.00 x	—
56348	U005	50.80 x	60.33 x	— x	5.16 x	—	50435	U031	50.80 x	73.02 x	— x	11.11 x	—
—	U014	50.80 x	60.33 x	— x	5.16 x	—	50435	U031	50.80 x	73.02 x	— x	11.11 x	—
55631	U	50.80 x	60.62 x	— x	9.53 x	—	8412	V	50.80 x	76.00 x	— x	11.50 x	—
59345	U004	50.80 x	61.00 x	— x	8.40 x	—	8122	V	50.80 x	76.20 x	— x	6.35 x	—
51181	U002	50.80 x	61.30 x	— x	4.70 x	—	—	U04A	50.80 x	76.20 x	— x	12.70 x	—
53151	U006	50.80 x	61.90 x	— x	6.35 x	—	52078	U009	50.80 x	76.20 x	— x	15.50 x	—
52570	U	50.80 x	61.91 x	— x	5.00 x	—	50429	U056	50.80 x	76.20 x	— x	17.46 x	—
52570	U001	50.80 x	61.91 x	— x	5.00 x	—	6068	CH	50.80 x	76.20 x	— x	28.58 x	—
52570	U001	50.80 x	61.91 x	— x	5.00 x	—	6137	CH	50.80 x	76.20 x	— x	33.00 x	—
56349	U	50.80 x	61.91 x	— x	6.35 x	9.52	55696	U073	50.80 x	78.00 x	— x	15.80 x	—
50349	U005	50.80 x	61.91 x	— x	9.52 x	6.30	6184	CH	50.80 x	80.16 x	— x	30.16 x	—
56350	U002	50.80 x	61.91 x	— x	9.53 x	—	3351	C	50.80 x	94.00 x	— x	20.00 x	—
8362	V	50.80 x	63.00 x	— x	3.70 x	—	—	U04A	50.80 x	95.25 x	— x	9.52 x	—
8362	V	50.80 x	63.00 x	— x	3.70 x	—	3050	C	50.80 x	114.30 x	5.00 x	15.87 x	—
56351	U003	50.80 x	63.00 x	— x	7.00 x	—	50735	U	50.80 x	120.65 x	— x	26.99 x	—
8096	V	50.80 x	63.50 x	— x	4.76 x	—	3537	C	50.80 x	152.00 x	5.00 x	24.00 x	—
53286	U001	50.80 x	63.50 x	— x	5.95 x	—	52569	U	51.00 x	60.00 x	— x	4.80 x	—
56352	U	50.80 x	63.50 x	— x	6.00 x	9.52	52569	U	51.00 x	60.00 x	— x	4.80 x	—
56353	U004	50.80 x	63.50 x	— x	6.33 x	—	52569	U002	51.00 x	60.00 x	— x	4.80 x	—
50357	U002	50.80 x	63.50 x	— x	6.35 x	—	56361	U031	51.00 x	60.00 x	— x	5.00 x	—
50357	U002	50.80 x	63.50 x	— x	6.35 x	—	56362	U004	51.00 x	60.00 x	— x	7.50 x	—
51967	U004	50.80 x	63.50 x	— x	6.35 x	—	59441	U032	51.00 x	60.00 x	— x	7.60 x	—
51967	U004	50.80 x	63.50 x	— x	6.35 x	—	52188	U04A	51.00 x	60.00 x	— x	8.00 x	—
53274	U004	50.80 x	63.50 x	— x	6.35 x	—	56363	U004	51.00 x	60.50 x	— x	6.00 x	—
55623	U04A	50.80 x	63.50 x	— x	6.35 x	—	56364	U002	51.00 x	61.00 x	— x	6.50 x	—
50791	U	50.80 x	63.50 x	— x	9.52 x	—	51413	U031	51.00 x	61.00 x	— x	6.50 x	—



Cód	Mod	Di x	De x	Esp. x	Ha1 x	Ha2	Cód	Mod	Di x	De x	Esp. x	Ha1 x	Ha2
56365	U002	51.00 x	62.00 x	— x	9.00 x	—	51563	U002	52.00 x	82.00 x	— x	15.00 x	—
F5083	W	51.00 x	63.00 x	— x	4.20 x	3.20	56398	U002	52.00 x	82.00 x	— x	15.00 x	—
F5082	W	51.00 x	63.00 x	— x	4.50 x	3.50	56399	U001	52.00 x	87.50 x	— x	18.00 x	—
52346	U001	51.00 x	63.00 x	— x	6.00 x	—	56400	U002	52.00 x	87.50 x	— x	18.00 x	—
56366	U002	51.00 x	63.00 x	— x	6.00 x	—	59439	U001	52.00 x	88.00 x	— x	25.00 x	—
56367	U007	51.00 x	63.00 x	— x	6.00 x	—	3357	C	52.00 x	95.50 x	— x	19.20 x	—
52303	U029	51.00 x	63.00 x	— x	8.00 x	—	56401	U007	52.39 x	61.12 x	— x	8.73 x	—
50690	U031	51.00 x	63.00 x	— x	9.00 x	—	56402	U	52.39 x	68.26 x	— x	7.14 x	7.94
56368	U001	51.00 x	63.00 x	— x	10.00 x	—	50376	U008	52.39 x	68.26 x	— x	7.94 x	7.14
56369	U002	51.00 x	63.00 x	— x	10.00 x	—	56403	U019	52.39 x	71.44 x	— x	9.53 x	—
56370	U002	51.00 x	63.00 x	— x	10.00 x	—	51923	U001	52.40 x	73.15 x	— x	9.50 x	—
—	CH	51.00 x	63.30 x	— x	10.70 x	—	51140	U	52.50 x	65.00 x	— x	9.00 x	—
8009	V	51.00 x	64.00 x	— x	7.00 x	—	3241	C	52.50 x	69.00 x	— x	13.00 x	—
56371	U004	51.00 x	64.00 x	— x	9.00 x	—	51352	U026	52.50 x	120.00 x	— x	27.00 x	—
56372	U002	51.00 x	66.00 x	— x	8.00 x	—	59443	U	52.60 x	60.00 x	— x	6.20 x	—
56373	U007	51.00 x	66.50 x	— x	8.00 x	—	56404	U031	53.00 x	62.00 x	— x	5.00 x	—
—	CH	51.00 x	66.50 x	— x	59.00 x	—	56405	U004	53.00 x	62.00 x	— x	6.00 x	—
52205	U	51.00 x	67.00 x	— x	8.00 x	—	52208	U	53.00 x	62.50 x	— x	5.00 x	—
55554	U053	51.00 x	68.50 x	— x	11.00 x	—	56406	U004	53.00 x	62.50 x	— x	5.00 x	—
F10922	W	51.00 x	69.40 x	— x	5.00 x	—	52381	U008	53.00 x	62.50 x	— x	5.00 x	6.50
—	CH	51.00 x	69.50 x	— x	38.50 x	—	51679	U	53.00 x	63.00 x	— x	5.00 x	—
56374	U004	51.00 x	76.00 x	— x	13.00 x	—	52526	U002	53.00 x	63.00 x	— x	6.00 x	—
56375	U003	51.00 x	80.00 x	— x	15.00 x	—	52135	U002	53.00 x	63.00 x	— x	7.00 x	—
56376	U019	51.10 x	67.00 x	— x	10.50 x	—	56407	U008	53.00 x	63.00 x	— x	7.00 x	—
56377	U049	51.40 x	66.40 x	— x	8.30 x	—	56408	U019	53.00 x	63.00 x	— x	7.00 x	—
50570	U065	51.40 x	66.40 x	— x	8.30 x	—	56409	U007	53.00 x	63.00 x	— x	11.00 x	—
50243	U032	51.50 x	59.00 x	— x	4.20 x	—	56410	U008	53.00 x	63.00 x	— x	11.00 x	—
50541	U004	51.50 x	60.00 x	— x	5.00 x	—	50290	U064	53.00 x	63.00 x	— x	11.00 x	—
8303	V	51.50 x	62.50 x	— x	10.00 x	—	52836	U008	53.00 x	63.00 x	— x	12.00 x	—
51388	U	51.50 x	66.50 x	— x	8.00 x	—	52836	U008	53.00 x	63.00 x	— x	12.00 x	—
55690	U002	51.80 x	63.00 x	— x	6.00 x	—	52836	U008	53.00 x	63.00 x	— x	12.00 x	—
50344	U044	52.00 x	57.00 x	— x	10.00 x	—	52394	U002	53.00 x	64.50 x	— x	3.00 x	—
56378	U001	52.00 x	58.00 x	— x	8.00 x	—	56411	U002	53.00 x	65.00 x	— x	6.00 x	—
56379	U002	52.00 x	58.00 x	— x	8.00 x	—	52368	U019	53.00 x	65.00 x	— x	6.00 x	—
F15231	ESPE	52.00 x	60.00 x	— x	6.35 x	—	56412	U002	53.00 x	65.00 x	— x	8.00 x	—
56380	U007	52.00 x	60.00 x	— x	8.00 x	—	56413	U001	53.00 x	65.00 x	— x	10.00 x	—
59354	UL	52.00 x	60.70 x	— x	5.50 x	7.00	56414	U002	53.00 x	65.00 x	— x	10.00 x	—
56381	U031	52.00 x	61.50 x	— x	9.80 x	—	56415	U031	53.00 x	67.00 x	— x	5.00 x	—
56382	U002	52.00 x	62.00 x	— x	6.00 x	—	51110	U	53.00 x	70.00 x	— x	8.00 x	7.00
56383	U002	52.00 x	62.00 x	— x	6.50 x	—	8225	V	53.00 x	70.00 x	— x	9.00 x	—
56384	U008	52.00 x	62.00 x	— x	7.00 x	—	51073	U004	53.00 x	71.00 x	— x	9.00 x	—
56385	U004	52.00 x	62.00 x	— x	12.00 x	—	8045	V	53.00 x	73.00 x	— x	9.60 x	—
50923	U013	52.00 x	62.40 x	— x	9.00 x	—	55716	U	53.00 x	75.00 x	— x	15.00 x	—
51898	U031	52.00 x	63.00 x	— x	10.00 x	—	56416	U002	53.00 x	75.00 x	— x	15.00 x	—
51898	U031	52.00 x	63.00 x	— x	10.00 x	—	8415	V	53.00 x	78.50 x	— x	9.70 x	—
56386	U002	52.00 x	64.00 x	— x	7.00 x	—	56417	U001	53.00 x	80.00 x	— x	12.00 x	—
52369	U003	52.00 x	64.00 x	— x	7.00 x	—	56418	U002	53.00 x	80.00 x	— x	12.00 x	—
51728	U007	52.00 x	64.00 x	— x	9.00 x	8.00	56419	U002	53.00 x	81.00 x	— x	12.00 x	—
56387	U001	52.00 x	64.00 x	— x	12.00 x	—	3317	C	53.00 x	101.60 x	— x	18.00 x	—
56388	U002	52.00 x	64.00 x	— x	12.00 x	—	8175	V	53.30 x	76.20 x	— x	8.80 x	—
51140	U	52.00 x	65.00 x	— x	11.00 x	—	56420	U002	53.50 x	63.50 x	— x	6.50 x	—
51440	U	52.00 x	65.00 x	— x	11.00 x	—	59247	U04A	53.50 x	65.80 x	— x	10.00 x	—
—	CH	52.00 x	68.50 x	— x	25.00 x	—	56421	U002	53.50 x	68.00 x	— x	5.50 x	—
56389	U002	52.00 x	70.00 x	— x	9.00 x	—	—	CH	53.50 x	70.00 x	— x	20.50 x	—
52539	U031	52.00 x	70.00 x	— x	9.00 x	—	—	CH	53.50 x	75.50 x	— x	46.50 x	—
56390	U001	52.00 x	70.00 x	— x	10.00 x	—	8371	V	53.80 x	76.10 x	— x	7.00 x	—
56391	U002	52.00 x	70.00 x	— x	10.00 x	—	53179	U	53.90 x	66.60 x	— x	9.50 x	—
56392	U001	52.00 x	72.00 x	— x	10.00 x	—	50909	U	53.97 x	63.50 x	— x	4.76 x	—
56393	U002	52.00 x	72.00 x	— x	10.00 x	—	50894	U	53.97 x	63.50 x	— x	4.79 x	—
56394	U004	52.00 x	72.00 x	— x	12.00 x	—	50596	U002	53.97 x	63.50 x	— x	7.94 x	—
6432	CH	52.00 x	72.00 x	— x	36.00 x	—	50596	U002	53.97 x	63.50 x	— x	7.94 x	—
—	CH	52.00 x	72.00 x	— x	47.00 x	—	53314	U04A	53.97 x	63.50 x	— x	9.53 x	—
56395	U001	52.00 x	75.00 x	— x	12.00 x	—	53314	U04A	53.97 x	63.50 x	— x	9.53 x	—
56396	U002	52.00 x	75.00 x	— x	12.00 x	—	50345	U024	53.97 x	63.50 x	— x	15.87 x	—
55677	U029	52.00 x	76.00 x	— x	8.00 x	—	56422	U004	53.98 x	63.50 x	— x	4.76 x	—
56397	U001	52.00 x	76.00 x	— x	14.00 x	—	56423	U002	53.98 x	63.50 x	— x	5.16 x	—
50509	U031	52.00 x	76.00 x	— x	17.00 x	—							



Cód	Mod	Di x	De x	Esp. x	Ha1 x	Ha2	Cód	Mod	Di x	De x	Esp. x	Ha1 x	Ha2
52737	U007	53.98 x	63.50 x	— x	7.93 x	—	51697	U022	55.00 x	64.00 x	— x	6.00 x	—
52737	U007	53.98 x	63.50 x	— x	7.93 x	—	50780	U031	55.00 x	64.00 x	— x	6.00 x	—
—	U04A	53.98 x	66.68 x	— x	6.35 x	—	6282	CH	55.00 x	64.00 x	— x	12.00 x	—
59250	U04A	53.98 x	66.68 x	— x	9.53 x	—	56452	U005	55.00 x	64.00 x	— x	13.50 x	—
56424	U031	53.98 x	69.85 x	— x	7.14 x	—	56453	U006	55.00 x	64.00 x	— x	13.50 x	—
—	CH	53.98 x	69.85 x	— x	21.00 x	—	59268	U	55.00 x	64.50 x	— x	7.30 x	—
—	U04A	53.98 x	73.03 x	— x	9.52 x	—	56455	U	55.00 x	65.00 x	— x	5.00 x	7.00
—	U04A	53.98 x	73.03 x	— x	15.87 x	—	56454	U002	55.00 x	65.00 x	— x	5.00 x	—
56425	U019	53.98 x	74.61 x	— x	9.53 x	—	51897	U011	55.00 x	65.00 x	— x	5.00 x	—
—	CH	53.98 x	77.79 x	— x	19.00 x	—	52925	U001	55.00 x	65.00 x	— x	6.50 x	—
56426	U001	54.00 x	60.00 x	— x	8.00 x	—	56456	U003	55.00 x	65.00 x	— x	6.50 x	—
56427	U002	54.00 x	60.00 x	— x	8.00 x	—	50553	U007	55.00 x	65.00 x	— x	7.00 x	5.00
56428	U007	54.00 x	62.00 x	— x	13.50 x	—	52917	U026	55.00 x	65.00 x	— x	7.00 x	—
56429	U008	54.00 x	62.00 x	— x	13.50 x	—	8352	V	55.00 x	65.00 x	— x	7.00 x	—
56430	U002	54.00 x	62.50 x	— x	5.00 x	—	52573	U	55.00 x	65.00 x	— x	9.52 x	—
50938	U	54.00 x	63.00 x	— x	6.00 x	—	3271	C	55.00 x	65.00 x	— x	12.00 x	—
52167	U	54.00 x	63.00 x	— x	6.00 x	—	56457	U004	55.00 x	65.00 x	— x	12.00 x	—
50840	U032	54.00 x	63.00 x	— x	6.70 x	—	56458	U007	55.00 x	65.00 x	— x	12.00 x	—
56431	U031	54.00 x	63.00 x	— x	8.00 x	—	56459	U008	55.00 x	65.00 x	— x	12.00 x	—
56432	U031	54.00 x	63.50 x	— x	5.00 x	—	56460	U005	55.00 x	65.00 x	— x	13.50 x	—
55731	U006	54.00 x	64.00 x	— x	9.30 x	—	56461	U006	55.00 x	65.00 x	— x	13.50 x	—
56433	U007	54.00 x	64.00 x	— x	13.50 x	—	56462	U007	55.00 x	65.00 x	— x	13.50 x	—
56434	U008	54.00 x	64.00 x	— x	13.50 x	—	56463	U008	55.00 x	65.00 x	— x	13.50 x	—
52667	U031	54.00 x	65.00 x	— x	6.00 x	—	51377	U	55.00 x	66.00 x	— x	6.00 x	—
52070	U032	54.00 x	66.50 x	— x	8.00 x	—	56464	U002	55.00 x	66.00 x	— x	7.00 x	—
—	U04A	54.00 x	67.64 x	— x	9.50 x	—	51448	U001	55.00 x	66.00 x	— x	7.50 x	—
56435	U002	54.00 x	70.00 x	— x	6.50 x	—	56465	U007	55.00 x	66.00 x	— x	13.50 x	—
56436	U002	54.00 x	70.00 x	— x	8.00 x	—	56466	U008	55.00 x	66.00 x	— x	13.50 x	—
8265	V	54.00 x	70.00 x	— x	8.00 x	—	51448	U001	55.00 x	67.00 x	— x	7.50 x	—
51484	U002	54.00 x	70.00 x	— x	9.00 x	—	56467	U004	55.00 x	67.00 x	— x	10.00 x	—
56437	U004	54.00 x	70.00 x	— x	12.00 x	—	56468	U001	55.00 x	68.00 x	— x	6.50 x	—
6374	CH	54.00 x	70.00 x	— x	35.00 x	—	56469	U002	55.00 x	68.00 x	— x	6.50 x	—
56438	U001	54.00 x	71.00 x	— x	10.00 x	—	56470	U002	55.00 x	68.00 x	— x	13.00 x	—
56439	U002	54.00 x	71.00 x	— x	10.00 x	—	52563	U04A	55.00 x	68.50 x	— x	9.50 x	—
56440	U002	54.00 x	72.00 x	— x	7.00 x	—	52003	U	55.00 x	69.00 x	— x	7.00 x	—
56441	U019	54.00 x	73.50 x	— x	12.00 x	—	53047	U	55.00 x	69.00 x	— x	9.50 x	—
—	CH	54.00 x	73.50 x	— x	34.00 x	—	53047	U	55.00 x	69.00 x	— x	9.50 x	—
3483	C	54.00 x	76.00 x	— x	3.00 x	—	53047	U04A	55.00 x	69.00 x	— x	9.50 x	—
56442	U001	54.00 x	80.00 x	— x	12.00 x	—	50887	U002	55.00 x	69.00 x	— x	10.00 x	—
56443	U002	54.00 x	80.00 x	— x	12.00 x	—	—	CH	55.00 x	69.00 x	— x	44.00 x	—
8048	V	54.00 x	85.00 x	— x	12.00 x	—	56471	U002	55.00 x	69.50 x	— x	8.00 x	—
3542	C	54.20 x	85.00 x	— x	17.47 x	—	56472	U001	55.00 x	70.00 x	— x	7.50 x	—
56444	U008	54.22 x	68.85 x	— x	8.73 x	—	53057	U002	55.00 x	70.00 x	— x	7.50 x	—
56445	U007	54.22 x	69.85 x	— x	8.73 x	—	53057	U002	55.00 x	70.00 x	— x	7.50 x	—
52422	U	54.30 x	64.00 x	— x	5.00 x	—	50268	U082	55.00 x	70.00 x	— x	7.50 x	—
51602	U	54.30 x	64.60 x	— x	5.00 x	—	56473	U002	55.00 x	70.00 x	— x	8.00 x	—
52153	U004	54.30 x	65.70 x	— x	7.00 x	—	56475	U004	55.00 x	70.00 x	— x	8.00 x	—
52153	U004	54.30 x	65.70 x	— x	7.00 x	—	56474	U005	55.00 x	70.00 x	— x	8.00 x	—
52634	U	54.37 x	63.50 x	— x	5.16 x	—	56476	U005	55.00 x	70.00 x	— x	9.00 x	—
56446	U031	54.37 x	63.50 x	— x	5.16 x	—	55570	U04A	55.00 x	70.00 x	— x	10.00 x	—
52901	U031	54.50 x	63.10 x	— x	5.60 x	—	51593	U001	55.00 x	70.00 x	— x	12.00 x	—
52901	U	54.50 x	63.10 x	— x	56.00 x	—	51022	U004	55.00 x	70.00 x	— x	12.00 x	—
52523	U	54.50 x	63.50 x	— x	6.00 x	—	56477	U004	55.00 x	70.00 x	— x	12.00 x	—
56447	U002	54.50 x	63.50 x	— x	6.00 x	—	51022	U004	55.00 x	70.00 x	— x	12.00 x	—
53145	U002	54.50 x	66.00 x	— x	10.00 x	—	56478	U007	55.00 x	70.00 x	— x	12.00 x	—
51262	U	54.50 x	69.50 x	— x	12.00 x	—	56479	U008	55.00 x	70.00 x	— x	12.00 x	—
50830	U031	54.50 x	76.00 x	— x	8.50 x	7.50	56480	U005	55.00 x	70.00 x	— x	15.00 x	—
56448	U031	54.50 x	76.00 x	— x	12.00 x	—	—	CH	55.00 x	70.50 x	— x	31.00 x	—
56449	U003	54.50 x	85.50 x	— x	15.00 x	—	56481	U003	55.00 x	71.00 x	— x	8.00 x	—
3205	C001	54.50 x	88.00 x	4.50 x	17.00 x	—	51215	U002	55.00 x	71.00 x	— x	10.00 x	—
52412	U	54.60 x	75.00 x	— x	13.00 x	—	59417	U004	55.00 x	72.00 x	— x	8.00 x	—
50863	U	55.00 x	61.50 x	— x	6.00 x	—	51424	U001	55.00 x	72.00 x	— x	8.50 x	—
51726	U	55.00 x	63.00 x	— x	5.00 x	—	50997	U069	55.00 x	72.00 x	— x	9.00 x	—
50663	U014	55.00 x	63.00 x	— x	5.00 x	—	50997	U069	55.00 x	72.00 x	— x	9.00 x	—
56450	U005	55.00 x	63.00 x	— x	12.00 x	—	50333	U001	55.00 x	73.00 x	— x	9.50 x	—
56451	U006	55.00 x	63.00 x	— x	12.00 x	—	56482	U001	55.00 x	73.00 x	— x	12.00 x	—
51697	U022	55.00 x	64.00 x	— x	6.00 x	—	56483	U002	55.00 x	73.00 x	— x	12.00 x	—



Cód	Mod	Di x	De x	Esp. x	Ha1 x	Ha2	Cód	Mod	Di x	De x	Esp. x	Ha1 x	Ha2
8328	V	55.00 x	75.00 x	— x	5.00 x	—	56519	U005	56.00 x	64.00 x	— x	12.00 x	—
55724	U04A	55.00 x	75.00 x	— x	7.00 x	—	56520	U006	56.00 x	64.00 x	— x	12.00 x	—
56484	U001	55.00 x	75.00 x	— x	9.00 x	—	51192	U	56.00 x	64.00 x	— x	12.50 x	—
56485	U002	55.00 x	75.00 x	— x	9.00 x	—	56521	U007	56.00 x	65.00 x	— x	8.00 x	—
51859	U	55.00 x	75.00 x	— x	10.00 x	—	56522	U008	56.00 x	65.00 x	— x	8.00 x	—
53477	U	55.00 x	75.00 x	— x	10.00 x	—	53101	U008	56.00 x	65.00 x	— x	10.70 x	—
56486	U001	55.00 x	75.00 x	— x	10.00 x	—	53101	U	56.00 x	65.00 x	— x	12.00 x	—
51429	U001	55.00 x	75.00 x	— x	10.00 x	—	56523	U002	56.00 x	66.00 x	— x	7.00 x	—
51859	U002	55.00 x	75.00 x	— x	10.00 x	—	51421	U005	56.00 x	66.00 x	— x	7.00 x	—
56487	U019	55.00 x	75.00 x	— x	10.00 x	—	56524	U005	56.00 x	67.00 x	— x	7.00 x	—
51297	U002	55.00 x	75.00 x	— x	10.50 x	—	52630	U	56.00 x	70.00 x	— x	7.50 x	—
56488	U002	55.00 x	75.00 x	— x	10.50 x	—	53444	U	56.00 x	70.00 x	— x	10.00 x	—
53007	U	55.00 x	75.00 x	— x	12.00 x	—	—	CH	56.00 x	70.00 x	— x	45.00 x	—
53007	U	55.00 x	75.00 x	— x	12.00 x	—	56525	U002	56.00 x	71.00 x	— x	6.00 x	—
56489	U004	55.00 x	75.00 x	— x	12.00 x	—	8387	V	56.00 x	71.00 x	— x	7.00 x	—
56490	U019	55.00 x	75.00 x	— x	15.00 x	—	52631	U001	56.00 x	71.00 x	— x	9.00 x	—
56491	U001	55.00 x	75.00 x	— x	18.00 x	—	55650	U002	56.00 x	71.00 x	— x	10.00 x	—
56492	U002	55.00 x	75.00 x	— x	18.00 x	—	56526	U04A	56.00 x	71.00 x	— x	10.00 x	—
56493	U004	55.00 x	75.00 x	— x	18.00 x	—	6206	CH	56.00 x	71.00 x	— x	22.50 x	—
—	CH	55.00 x	75.00 x	— x	36.50 x	—	52820	U	56.00 x	72.00 x	— x	10.00 x	—
—	CH	55.00 x	75.00 x	— x	69.00 x	—	52820	U	56.00 x	72.00 x	— x	10.00 x	—
53064	U04A	55.00 x	76.00 x	— x	7.00 x	—	50370	U065	56.00 x	73.00 x	— x	8.00 x	—
53064	U04A	55.00 x	76.00 x	— x	7.00 x	—	56527	U019	56.00 x	74.00 x	— x	12.00 x	—
56494	U001	55.00 x	79.00 x	— x	12.00 x	—	6292	CH	56.00 x	75.00 x	— x	30.00 x	—
56495	U005	55.00 x	79.00 x	— x	12.00 x	—	F12376	J	56.00 x	75.50 x	— x	14.00 x	16.00
50314	U001	55.00 x	80.00 x	— x	12.00 x	—	56528	U019	56.00 x	76.00 x	— x	9.00 x	—
56496	U002	55.00 x	80.00 x	— x	12.00 x	—	56529	U001	56.00 x	76.00 x	— x	10.00 x	—
56497	U019	55.00 x	80.00 x	— x	12.00 x	—	56530	U002	56.00 x	76.00 x	— x	10.00 x	—
50834	U003	55.00 x	80.00 x	— x	14.00 x	—	56531	U001	56.00 x	76.00 x	— x	15.00 x	—
50737	U	55.00 x	80.00 x	— x	15.00 x	—	56532	U002	56.00 x	76.00 x	— x	15.00 x	—
56498	U001	55.00 x	80.00 x	— x	18.00 x	—	—	CH	56.00 x	76.00 x	— x	31.00 x	—
56499	U002	55.00 x	80.00 x	— x	18.00 x	—	—	CH	56.00 x	76.00 x	— x	46.00 x	—
51118	U029	55.00 x	81.00 x	— x	14.00 x	—	56533	U004	56.00 x	79.00 x	— x	15.00 x	—
56500	U001	55.00 x	85.00 x	— x	10.00 x	—	56534	U001	56.00 x	80.00 x	— x	10.00 x	—
56501	U002	55.00 x	85.00 x	— x	10.00 x	—	56536	U002	56.00 x	80.00 x	— x	10.00 x	—
56502	U002	55.00 x	85.00 x	— x	15.00 x	—	56537	U001	56.00 x	80.00 x	— x	12.00 x	—
56503	U019	55.00 x	85.00 x	— x	15.00 x	—	56538	U002	56.00 x	80.00 x	— x	12.00 x	—
56504	U001	55.00 x	86.00 x	— x	15.00 x	—	56539	U001	56.00 x	80.00 x	— x	20.00 x	—
56505	U002	55.00 x	86.00 x	— x	15.00 x	—	56540	U002	56.00 x	80.00 x	— x	20.00 x	—
3156	C	55.00 x	90.00 x	5.00 x	15.00 x	—	6443	CH	56.00 x	80.00 x	— x	76.00 x	—
56506	U001	55.00 x	95.00 x	— x	25.00 x	—	56541	U001	56.00 x	82.00 x	— x	13.00 x	—
56507	U002	55.00 x	95.00 x	— x	25.00 x	—	56542	U002	56.00 x	82.00 x	— x	13.00 x	—
56508	U001	55.00 x	100.00 x	— x	20.00 x	—	56543	U001	56.00 x	90.00 x	— x	16.00 x	—
56509	U002	55.00 x	100.00 x	— x	20.00 x	—	56544	U002	56.00 x	90.00 x	— x	16.00 x	—
3249	C	55.00 x	145.00 x	3.00 x	25.00 x	—	3364	C	56.00 x	103.00 x	— x	20.00 x	—
53431	U	55.20 x	63.70 x	10.50 x	11.50 x	—	55615	U	56.50 x	66.50 x	6.35 x	—	—
50028	U002	55.30 x	75.00 x	— x	10.50 x	—	56545	U002	56.50 x	73.00 x	— x	8.50 x	—
56510	U031	55.50 x	68.50 x	— x	17.00 x	—	56546	U001	56.62 x	72.23 x	— x	7.75 x	—
56511	U002	55.50 x	75.50 x	— x	10.00 x	—	56547	U002	56.62 x	72.23 x	— x	7.75 x	—
50920	U	55.56 x	63.50 x	— x	4.76 x	—	51016	U	57.00 x	64.00 x	— x	7.00 x	—
52128	U004	55.56 x	68.28 x	— x	9.52 x	—	53530	U	57.00 x	65.00 x	— x	6.00 x	—
F1903	W	55.56 x	69.95 x	— x	4.37 x	3.50	52940	U	57.00 x	65.00 x	— x	7.00 x	—
56512	U004	55.56 x	73.82 x	— x	11.51 x	—	52940	U	57.00 x	65.00 x	— x	7.00 x	—
56513	U019	55.56 x	76.20 x	— x	9.53 x	—	52571	U	57.00 x	65.00 x	— x	8.00 x	—
56514	U	55.56 x	76.20 x	— x	10.32 x	—	56548	U001	57.00 x	65.00 x	— x	16.00 x	—
50423	U031	55.56 x	76.20 x	— x	10.32 x	—	56549	U002	57.00 x	65.00 x	— x	16.00 x	—
56515	U031	56.00 x	62.50 x	— x	5.00 x	—	56550	U004	57.00 x	66.00 x	— x	7.00 x	—
53059	U	56.00 x	63.00 x	— x	5.20 x	—	51038	U	57.00 x	66.00 x	— x	9.50 x	—
53059	U	56.00 x	63.00 x	— x	6.35 x	—	56551	U001	57.00 x	69.00 x	— x	6.50 x	—
52971	U	56.00 x	63.00 x	— x	9.50 x	—	56552	U002	57.00 x	69.00 x	— x	6.50 x	—
52971	U	56.00 x	63.00 x	— x	9.50 x	—	56553	U008	57.00 x	69.00 x	— x	8.00 x	—
52971	U04A	56.00 x	63.00 x	— x	9.50 x	—	56554	U	57.00 x	70.00 x	— x	5.00 x	8.00
56516	U005	56.00 x	63.00 x	— x	12.00 x	—	52438	U003	57.00 x	70.00 x	— x	7.00 x	—
52443	U007	56.00 x	64.00 x	— x	8.00 x	—	52438	U003	57.00 x	70.00 x	— x	7.00 x	—
56517	U007	56.00 x	64.00 x	— x	8.00 x	—	8153	V	57.00 x	70.00 x	— x	7.00 x	—
56518	U008	56.00 x	64.00 x	— x	8.00 x	—	50554	U088	57.00 x	70.00 x	— x	8.00 x	5.00





Cód	Mod	Di x	De x	Esp. x	Ha1 x	Ha2	Cód	Mod	Di x	De x	Esp. x	Ha1 x	Ha2
—	U04A	57.00 x	70.00 x	— x	9.00 x	—	52101	U031	58.00 x	65.00 x	— x	6.50 x	—
56555	U002	57.00 x	70.00 x	— x	12.00 x	—	51757	U	58.00 x	68.00 x	— x	7.00 x	—
52442	U031	57.00 x	70.00 x	— x	12.00 x	—	51757	U	58.00 x	68.00 x	— x	7.00 x	—
—	CH	57.00 x	70.00 x	— x	44.50 x	—	51950	U	58.00 x	68.00 x	— x	7.30 x	6.20
56556	U019	57.00 x	70.50 x	— x	9.60 x	—	8334	V	58.00 x	68.00 x	— x	9.00 x	—
—	CH	57.00 x	71.00 x	— x	24.60 x	—	56579	U005	58.00 x	68.00 x	— x	10.00 x	—
50810	U	57.00 x	72.00 x	— x	4.50 x	—	56580	U006	58.00 x	68.00 x	— x	10.00 x	—
52707	U066	57.00 x	72.00 x	— x	4.70 x	—	50979	U034	58.00 x	68.60 x	— x	19.00 x	18.00
8248	V	57.00 x	72.50 x	— x	6.80 x	—	56581	U002	58.00 x	70.00 x	— x	5.00 x	—
56557	U004	57.00 x	73.00 x	— x	12.00 x	—	56582	U001	58.00 x	70.00 x	— x	6.00 x	—
56558	U001	57.00 x	73.00 x	— x	12.50 x	—	56583	U002	58.00 x	70.00 x	— x	6.00 x	—
56559	U002	57.00 x	73.00 x	— x	12.50 x	—	56584	U001	58.00 x	70.00 x	— x	8.00 x	—
56560	U002	57.00 x	73.00 x	— x	13.00 x	—	56585	U002	58.00 x	70.00 x	— x	8.00 x	—
56561	U001	57.00 x	73.00 x	— x	15.00 x	—	55684	U008	58.00 x	70.00 x	— x	8.50 x	—
56562	U002	57.00 x	73.00 x	— x	15.00 x	—	59257	U008	58.00 x	71.00 x	— x	10.00 x	12.00
51364	U	57.00 x	74.00 x	— x	9.00 x	8.00	52835	U046	58.00 x	71.50 x	— x	12.00 x	—
56563	U007	57.00 x	75.00 x	— x	8.00 x	—	52835	U046	58.00 x	71.50 x	— x	12.00 x	—
56564	U019	57.00 x	75.00 x	— x	9.00 x	—	59286	U008	58.00 x	72.00 x	— x	10.50 x	12.50
56565	U	57.00 x	75.00 x	— x	11.00 x	13.00	56586	U004	58.00 x	72.00 x	— x	11.00 x	—
50632	U008	57.00 x	75.00 x	— x	13.00 x	11.50	56587	U007	58.00 x	72.00 x	— x	12.00 x	—
56566	U031	57.00 x	77.00 x	— x	8.00 x	—	56588	U008	58.00 x	72.00 x	— x	12.00 x	—
—	CH	57.00 x	77.00 x	— x	46.00 x	—	50900	U001	58.00 x	73.00 x	— x	10.00 x	—
56567	U001	57.00 x	80.00 x	— x	11.50 x	—	56589	U001	58.00 x	74.00 x	— x	12.00 x	—
56568	U002	57.00 x	80.00 x	— x	11.50 x	—	56590	U002	58.00 x	74.00 x	— x	12.00 x	—
53202	U	57.00 x	82.00 x	— x	12.70 x	—	56591	U001	58.00 x	74.00 x	— x	13.00 x	—
8166	V	57.00 x	85.00 x	— x	8.00 x	—	56592	U002	58.00 x	74.00 x	— x	13.00 x	—
—	CH	57.00 x	91.00 x	— x	40.00 x	—	56593	U001	58.00 x	74.00 x	— x	15.00 x	—
53271	U002	57.15 x	66.68 x	— x	4.76 x	—	56595	U002	58.00 x	74.00 x	— x	156.00 x	—
56569	U006	57.15 x	66.68 x	— x	7.14 x	—	50197	U026	58.00 x	75.00 x	— x	13.00 x	—
56570	U002	57.15 x	68.26 x	— x	11.11 x	—	56596	U002	58.00 x	76.00 x	— x	10.00 x	—
—	U04A	57.15 x	69.85 x	— x	6.35 x	—	56597	U007	58.00 x	76.50 x	— x	10.50 x	—
51123	U006	57.15 x	69.85 x	— x	9.50 x	7.93	51873	U002	58.00 x	80.00 x	— x	10.00 x	—
51123	U006	57.15 x	69.85 x	— x	9.50 x	—	56598	U002	58.00 x	80.00 x	— x	10.00 x	—
56571	U002	57.15 x	69.85 x	— x	9.53 x	—	3443	C	58.00 x	81.50 x	4.00 x	12.00 x	—
53176	U04A	57.15 x	69.85 x	— x	9.53 x	—	56599	U001	58.00 x	82.00 x	— x	10.00 x	—
6004	CH	57.15 x	69.85 x	— x	16.67 x	—	56600	U002	58.00 x	82.00 x	— x	10.00 x	—
51959	U005	57.15 x	70.00 x	— x	7.80 x	6.50	56601	U001	58.00 x	82.00 x	— x	12.00 x	—
56572	U002	57.15 x	73.03 x	— x	7.94 x	—	56602	U002	58.00 x	82.00 x	— x	12.00 x	—
8263	V	57.15 x	73.03 x	— x	7.94 x	—	6350	CH	58.00 x	87.00 x	— x	27.50 x	—
—	U04A	57.15 x	73.03 x	— x	12.70 x	—	—	CH	58.00 x	87.00 x	— x	47.00 x	—
52054	U004	57.15 x	73.07 x	— x	11.91 x	—	3394	C	58.00 x	89.00 x	— x	11.70 x	—
50713	U003	57.15 x	76.20 x	— x	9.52 x	7.20	6318	CH	58.00 x	90.00 x	— x	40.00 x	—
50713	U003	57.15 x	76.20 x	— x	9.52 x	12.00	56603	U001	58.00 x	91.00 x	— x	15.00 x	—
53436	U04A	57.15 x	76.20 x	— x	9.52 x	—	56604	U002	58.00 x	91.00 x	— x	15.00 x	—
56573	U001	57.15 x	76.20 x	— x	9.53 x	—	3550	C	58.00 x	102.00 x	— x	16.50 x	—
56574	U002	57.15 x	76.20 x	— x	9.53 x	—	53415	U001	58.10 x	71.60 x	— x	12.00 x	—
56575	U019	57.15 x	76.20 x	— x	9.53 x	—	51500	U	58.50 x	66.00 x	— x	13.00 x	—
51000	U008	57.15 x	76.20 x	— x	11.10 x	12.70	51495	U	58.50 x	66.50 x	— x	5.00 x	—
8099	V	57.15 x	76.20 x	— x	11.50 x	—	56605	U004	58.50 x	70.00 x	— x	8.00 x	—
8099	V	57.15 x	76.20 x	— x	11.50 x	—	56606	U004	58.50 x	76.00 x	— x	16.00 x	—
50740	U04A	57.15 x	76.20 x	— x	15.87 x	—	56607	U003	58.50 x	76.20 x	— x	12.70 x	—
6042	CH	57.15 x	76.20 x	— x	25.40 x	—	51592	U019	58.50 x	76.20 x	— x	12.70 x	—
6042	CH	57.15 x	76.20 x	— x	25.40 x	—	50457	U001	58.74 x	76.20 x	— x	12.70 x	—
—	CH	57.15 x	76.20 x	— x	32.50 x	—	6035	CH	58.74 x	76.20 x	— x	28.58 x	—
6112	CH	57.15 x	76.20 x	— x	38.50 x	—	3090	C	58.74 x	79.37 x	3.50 x	11.11 x	—
50175	U006	57.15 x	82.55 x	— x	12.70 x	—	56608	U001	58.74 x	79.38 x	— x	11.11 x	—
6297	CH	57.15 x	82.55 x	— x	41.20 x	—	—	CH	58.74 x	80.96 x	— x	55.50 x	—
8226	V	57.20 x	66.00 x	— x	10.00 x	—	—	CH	58.75 x	190.50 x	— x	54.50 x	—
52354	U001	57.20 x	69.70 x	— x	8.30 x	—	55587	U	59.00 x	69.00 x	— x	5.00 x	—
52252	U002	57.20 x	69.70 x	— x	8.30 x	—	56609	U004	59.00 x	69.00 x	— x	11.50 x	—
56576	U003	57.20 x	69.70 x	— x	8.30 x	—	50621	U024	59.00 x	69.00 x	— x	15.00 x	—
56577	U004	57.50 x	67.00 x	— x	5.80 x	—	56610	U002	59.00 x	70.00 x	— x	12.00 x	—
—	CH	57.50 x	73.50 x	— x	31.00 x	—	52244	U063	59.00 x	70.60 x	— x	9.00 x	5.50
F6254	J	57.50 x	87.00 x	— x	16.30 x	20.00	50300	U019	59.00 x	74.00 x	— x	16.00 x	—
53122	U04A	57.60 x	76.20 x	— x	14.00 x	—	50567	U002	59.00 x	75.00 x	— x	8.00 x	—
50284	U005	57.70 x	68.00 x	— x	8.00 x	—	56611	U002	59.00 x	75.00 x	— x	15.00 x	—
56578	U002	58.00 x	64.50 x	— x	4.50 x	—	56612	U002	59.00 x	76.00 x	— x	8.00 x	—



Cód	Mod	Di x	De x	Esp. x	Ha1 x	Ha2	Cód	Mod	Di x	De x	Esp. x	Ha1 x	Ha2
51745	U023	59.00 x	76.00 x	— x	11.00 x	—	52243	U001	60.00 x	72.00 x	— x	12.00 x	—
51745	U023	59.00 x	76.00 x	— x	11.00 x	—	52243	U001	60.00 x	72.00 x	— x	12.00 x	—
6208	CH	59.00 x	77.00 x	— x	25.00 x	—	51442	U002	60.00 x	72.00 x	— x	12.50 x	—
51272	U046	59.00 x	78.00 x	— x	11.50 x	—	56646	U002	60.00 x	72.00 x	— x	12.50 x	—
50330	U004	59.00 x	78.50 x	— x	13.00 x	—	51442	U003	60.00 x	72.00 x	— x	12.50 x	—
50377	U031	59.00 x	78.70 x	— x	8.60 x	—	50517	U027	60.00 x	73.00 x	— x	5.50 x	—
56613	U001	59.00 x	80.00 x	— x	10.00 x	—	56647	U002	60.00 x	73.50 x	— x	7.00 x	—
—	CH	59.00 x	81.00 x	— x	41.00 x	—	51139	U	60.00 x	73.50 x	— x	8.50 x	—
56614	U001	59.00 x	90.00 x	— x	15.00 x	—	51760	U	60.00 x	73.60 x	— x	6.50 x	—
56615	U002	59.00 x	90.00 x	— x	15.00 x	—	50783	U002	60.00 x	74.00 x	— x	7.00 x	—
56616	U001	59.00 x	95.00 x	— x	17.00 x	—	56648	U029	60.00 x	74.00 x	— x	7.00 x	—
56617	U002	59.00 x	95.00 x	— x	17.00 x	—	8272	V	60.00 x	74.00 x	— x	7.20 x	—
3290	C	59.00 x	130.00 x	— x	22.00 x	—	—	CH	60.00 x	74.50 x	— x	44.50 x	—
56618	U001	59.20 x	92.00 x	— x	20.00 x	—	52983	U031	60.00 x	75.00 x	— x	7.50 x	—
51845	U029	59.50 x	66.50 x	— x	2.80 x	—	52983	U031	60.00 x	75.00 x	— x	7.50 x	—
56619	U031	59.50 x	70.00 x	— x	5.50 x	—	56649	U002	60.00 x	75.00 x	— x	8.00 x	—
56620	U002	59.50 x	74.00 x	— x	7.00 x	—	56650	U005	60.00 x	75.00 x	— x	8.00 x	—
51217	U	59.50 x	74.00 x	— x	9.50 x	—	8227	V	60.00 x	75.00 x	— x	8.00 x	—
56621	U002	59.50 x	74.00 x	— x	9.50 x	—	8171	V	60.00 x	75.00 x	— x	8.00 x	—
56622	U002	59.50 x	74.50 x	— x	8.00 x	—	F4637	W	60.00 x	75.00 x	— x	8.00 x	7.00
3244	C	59.50 x	82.50 x	3.97 x	12.50 x	—	56651	U002	60.00 x	75.00 x	— x	9.00 x	—
56623	U002	59.50 x	92.00 x	— x	20.00 x	—	51755	U	60.00 x	75.00 x	— x	9.20 x	—
52640	U	60.00 x	67.00 x	— x	6.00 x	—	51755	U	60.00 x	75.00 x	— x	9.20 x	—
56625	U001	60.00 x	68.00 x	— x	4.00 x	—	52364	U003	60.00 x	75.00 x	— x	9.20 x	—
56626	U002	60.00 x	68.00 x	— x	4.00 x	—	51468	U	60.00 x	75.00 x	— x	11.00 x	—
59411	UL	60.00 x	68.00 x	— x	5.00 x	7.00	50675	U002	60.00 x	75.00 x	— x	12.00 x	—
59274	UL	60.00 x	68.00 x	— x	6.00 x	8.00	56653	U004	60.00 x	75.00 x	— x	12.00 x	—
53312	U004	60.00 x	68.00 x	— x	6.35 x	—	50675	U004	60.00 x	75.00 x	— x	12.00 x	—
52508	U	60.00 x	68.00 x	— x	8.00 x	—	50140	U019	60.00 x	75.00 x	— x	12.00 x	—
56627	U001	60.00 x	68.00 x	— x	8.00 x	—	56654	U002	60.00 x	75.00 x	— x	14.00 x	—
56628	U002	60.00 x	68.00 x	— x	8.00 x	—	53080	U04A	60.00 x	75.00 x	— x	21.00 x	—
50524	U020	60.00 x	68.00 x	— x	8.00 x	—	6127	CH	60.00 x	75.00 x	— x	22.50 x	—
56629	U006	60.00 x	68.00 x	— x	11.50 x	—	51746	U	60.00 x	76.00 x	— x	8.00 x	—
56630	U005	60.00 x	68.00 x	— x	12.50 x	—	51837	U	60.00 x	76.00 x	— x	8.00 x	—
56631	U019	60.00 x	68.00 x	— x	13.00 x	—	8276	V	60.00 x	76.00 x	— x	8.00 x	—
56632	U007	60.00 x	68.00 x	— x	13.50 x	—	56655	U002	60.00 x	76.00 x	— x	9.00 x	—
56633	U008	60.00 x	68.00 x	— x	13.50 x	—	56656	U002	60.00 x	76.00 x	— x	10.00 x	—
50270	U024	60.00 x	68.00 x	— x	14.00 x	—	50171	U035	60.00 x	76.00 x	— x	13.00 x	—
51129	U	60.00 x	69.00 x	— x	6.30 x	—	56657	U001	60.00 x	76.00 x	— x	14.00 x	—
52818	U	60.00 x	69.80 x	— x	5.50 x	—	56658	U002	60.00 x	76.00 x	— x	14.00 x	—
51733	U	60.00 x	70.00 x	— x	6.00 x	—	8228	V	60.00 x	76.40 x	— x	6.40 x	—
56634	U004	60.00 x	70.00 x	— x	6.00 x	—	51485	U	60.00 x	76.50 x	— x	9.00 x	—
56635	U002	60.00 x	70.00 x	— x	7.00 x	—	50828	U002	60.00 x	78.00 x	— x	5.00 x	—
55612	U04A	60.00 x	70.00 x	— x	7.50 x	—	50946	U008	60.00 x	78.00 x	— x	8.00 x	—
55612	U04A	60.00 x	70.00 x	— x	7.50 x	—	8376	V	60.00 x	78.50 x	— x	7.00 x	—
55612	U04A	60.00 x	70.00 x	— x	7.50 x	—	56659	U002	60.00 x	78.50 x	— x	12.50 x	—
56636	U007	60.00 x	70.00 x	— x	9.00 x	—	56660	U	60.00 x	79.00 x	— x	9.50 x	—
—	U04A	60.00 x	70.00 x	— x	9.00 x	—	50161	U068	60.00 x	79.00 x	— x	9.50 x	—
52507	U005	60.00 x	70.00 x	— x	10.00 x	—	56662	U002	60.00 x	79.00 x	— x	10.00 x	—
51561	U	60.00 x	70.00 x	— x	10.50 x	—	50549	U069	60.00 x	79.00 x	— x	10.50 x	—
56637	U006	60.00 x	70.00 x	— x	11.50 x	10.00	6302	CH	60.00 x	79.00 x	— x	40.00 x	—
3269	C	60.00 x	70.00 x	— x	12.00 x	—	53483	U029	60.00 x	80.00 x	— x	5.00 x	—
52076	U	60.00 x	70.00 x	— x	12.00 x	—	8107	V	60.00 x	80.00 x	— x	9.00 x	—
51492	U004	60.00 x	70.00 x	— x	12.00 x	—	8107	V	60.00 x	80.00 x	— x	9.00 x	—
51082	U	60.00 x	70.00 x	— x	13.50 x	—	52305	U	60.00 x	80.00 x	— x	10.00 x	—
56638	U005	60.00 x	70.00 x	— x	13.50 x	—	56663	U001	60.00 x	80.00 x	— x	10.00 x	—
56639	U006	60.00 x	70.00 x	— x	13.50 x	—	51196	U003	60.00 x	80.00 x	— x	10.00 x	—
56640	U007	60.00 x	70.00 x	— x	13.50 x	—	56665	U003	60.00 x	80.00 x	— x	10.00 x	—
56641	U008	60.00 x	70.00 x	— x	13.50 x	—	50037	U004	60.00 x	80.00 x	— x	10.00 x	—
51191	U	60.00 x	70.00 x	— x	14.00 x	—	50037	U004	60.00 x	80.00 x	— x	10.00 x	—
51191	U020	60.00 x	70.00 x	— x	14.00 x	—	56666	U004	60.00 x	80.00 x	— x	10.00 x	—
56642	U002	60.00 x	71.00 x	— x	8.00 x	—	56667	U019	60.00 x	80.00 x	— x	10.00 x	—
56643	U002	60.00 x	72.00 x	— x	6.00 x	—	56664	U061	60.00 x	80.00 x	— x	10.00 x	—
56644	U004	60.00 x	72.00 x	— x	8.00 x	—	51763	U079	60.00 x	80.00 x	— x	10.30 x	—
59151	U005	60.00 x	72.00 x	— x	8.50 x	—	8112	V	60.00 x	80.00 x	— x	10.40 x	—
56645	U002	60.00 x	72.00 x	— x	9.00 x	—	56668	U003	60.00 x	80.00 x	— x	11.00 x	—
52965	U005	60.00 x	72.00 x	— x	9.50 x	—	50739	U	60.00 x	80.00 x	— x	12.00 x	—



Cód	Mod	Di x	De x	Esp. x	Ha1 x	Ha2	Cód	Mod	Di x	De x	Esp. x	Ha1 x	Ha2
51078	U	60.00 x	80.00 x	— x	12.00 x	—	52534	U001	60.30 x	82.50 x	— x	14.00 x	—
51078	U	60.00 x	80.00 x	— x	12.00 x	—	8095	V	60.32 x	74.61 x	— x	6.35 x	—
50739	U	60.00 x	80.00 x	— x	12.00 x	—	50417	U002	60.32 x	76.20 x	— x	9.52 x	—
52335	U002	60.00 x	80.00 x	— x	12.00 x	—	51570	U	60.32 x	76.20 x	— x	12.70 x	—
56669	U002	60.00 x	80.00 x	— x	12.00 x	—	6347	CH	60.32 x	79.37 x	— x	— x	—
56670	U004	60.00 x	80.00 x	— x	12.00 x	—	50178	U047	60.32 x	80.96 x	— x	19.05 x	—
50850	U046	60.00 x	80.00 x	— x	12.00 x	—	56694	U031	60.33 x	68.26 x	— x	4.76 x	—
50850	U046	60.00 x	80.00 x	— x	12.00 x	—	56695	U006	60.33 x	68.26 x	— x	12.70 x	—
51675	U	60.00 x	80.00 x	— x	12.50 x	—	—	U04A	60.33 x	73.03 x	— x	6.35 x	—
53445	U	60.00 x	80.00 x	— x	12.70 x	—	—	U04A	60.33 x	73.03 x	— x	9.52 x	—
F3267	J	60.00 x	80.00 x	— x	13.00 x	18.00	56696	U002	60.33 x	74.61 x	— x	7.94 x	—
56671	U005	60.00 x	80.00 x	— x	13.00 x	—	6076	CH	60.33 x	74.61 x	— x	25.40 x	—
50186	U004	60.00 x	80.00 x	— x	14.00 x	—	56697	U002	60.33 x	75.01 x	— x	7.94 x	—
50186	U004	60.00 x	80.00 x	— x	14.00 x	—	52384	U	60.33 x	76.20 x	— x	7.94 x	—
56672	U007	60.00 x	80.00 x	— x	14.00 x	—	52384	U	60.33 x	76.20 x	— x	7.94 x	—
56673	U008	60.00 x	80.00 x	— x	14.00 x	—	56698	U005	60.33 x	76.20 x	— x	7.94 x	—
50327	U002	60.00 x	80.00 x	— x	15.00 x	—	56699	U002	60.33 x	76.20 x	— x	9.53 x	—
6210	CH	60.00 x	80.00 x	— x	15.00 x	—	—	U04A	60.33 x	79.38 x	— x	9.52 x	—
53073	U04A	60.00 x	80.00 x	— x	15.87 x	—	56700	U019	60.33 x	79.38 x	— x	9.53 x	—
53073	U04A	60.00 x	80.00 x	— x	15.87 x	—	—	U04A	60.33 x	79.38 x	— x	15.87 x	—
52795	U	60.00 x	80.00 x	— x	16.00 x	—	56701	U007	60.33 x	80.17 x	— x	9.53 x	—
56674	U001	60.00 x	80.00 x	— x	18.00 x	—	3295	C	60.33 x	82.55 x	— x	11.11 x	—
56675	U002	60.00 x	80.00 x	— x	18.00 x	—	56702	U019	60.33 x	85.73 x	— x	12.70 x	—
6000	CH	60.00 x	80.00 x	— x	29.00 x	—	—	U04A	60.33 x	95.25 x	— x	9.52 x	—
6092	CH	60.00 x	80.00 x	— x	35.00 x	—	56703	U001	60.33 x	98.43 x	— x	14.29 x	—
6002	CH	60.00 x	80.00 x	— x	38.00 x	—	56704	U002	60.33 x	98.43 x	— x	14.29 x	—
6148	CH	60.00 x	80.00 x	— x	53.00 x	—	50630	U002	60.50 x	75.50 x	— x	8.20 x	—
50151	U047	60.00 x	80.60 x	— x	18.50 x	—	—	CH	60.50 x	79.00 x	— x	125.00 x	—
50151	U047	60.00 x	80.60 x	— x	18.50 x	—	56705	U001	61.00 x	73.00 x	— x	6.00 x	—
50151	U047	60.00 x	80.60 x	— x	18.50 x	—	56706	U002	61.00 x	73.00 x	— x	6.00 x	—
50651	U003	60.00 x	81.00 x	— x	7.50 x	—	56707	U003	61.00 x	74.00 x	— x	10.00 x	—
3343	C	60.00 x	81.50 x	— x	11.50 x	—	56708	U002	61.00 x	75.00 x	— x	5.00 x	—
6388	CH	60.00 x	82.50 x	— x	31.00 x	—	56709	U002	61.00 x	77.50 x	— x	8.00 x	—
56676	U001	60.00 x	84.00 x	— x	10.00 x	—	51521	U	61.00 x	78.00 x	— x	10.00 x	—
56677	U002	60.00 x	84.00 x	— x	10.00 x	—	52624	U04A	61.00 x	79.00 x	— x	9.50 x	—
56678	U001	60.00 x	84.00 x	— x	12.00 x	—	52636	U003	61.00 x	79.50 x	— x	11.00 x	—
56679	U002	60.00 x	84.00 x	— x	12.00 x	—	56710	U002	61.00 x	80.50 x	— x	10.00 x	—
56680	U002	60.00 x	85.00 x	— x	12.00 x	—	51639	U053	61.00 x	81.00 x	— x	18.00 x	—
50976	U019	60.00 x	85.00 x	— x	12.00 x	—	51639	U053	61.00 x	81.00 x	— x	18.00 x	14.50
52301	U	60.00 x	85.00 x	— x	15.00 x	12.50	50413	U003	61.00 x	82.00 x	— x	12.00 x	—
8001	V	60.00 x	85.00 x	— x	15.00 x	—	56711	U001	61.00 x	82.00 x	— x	18.00 x	—
6427	CH	60.00 x	85.00 x	— x	91.00 x	—	56712	U002	61.00 x	82.00 x	— x	18.00 x	—
6427	CH	60.00 x	85.00 x	— x	91.00 x	—	—	CH	61.00 x	83.00 x	— x	39.00 x	—
56681	U001	60.00 x	86.70 x	— x	15.00 x	—	51503	U002	61.40 x	75.40 x	— x	9.80 x	—
56682	U002	60.00 x	86.70 x	— x	15.00 x	—	56713	U006	61.50 x	74.00 x	— x	9.00 x	—
8417	V	60.00 x	90.00 x	— x	12.00 x	—	56714	U006	61.50 x	76.00 x	— x	8.00 x	—
56683	U001	60.00 x	90.00 x	— x	15.00 x	—	56715	U031	61.50 x	85.00 x	— x	10.00 x	—
56684	U002	60.00 x	90.00 x	— x	15.00 x	—	6441	CH	61.91 x	76.20 x	— x	19.00 x	—
56685	U019	60.00 x	90.00 x	— x	15.00 x	—	—	CH	61.91 x	79.38 x	— x	26.00 x	—
56686	U001	60.00 x	92.00 x	— x	15.00 x	—	—	CH	61.91 x	82.55 x	— x	55.00 x	—
56687	U002	60.00 x	92.00 x	— x	15.00 x	—	—	CH	61.91 x	88.90 x	— x	47.63 x	—
3164	C	60.00 x	95.00 x	3.50 x	16.00 x	—	3047	C	61.91 x	100.80 x	3.17 x	12.70 x	—
56688	U001	60.00 x	95.00 x	— x	17.00 x	—	51320	U026	61.98 x	120.00 x	— x	27.00 x	—
56689	U002	60.00 x	95.00 x	— x	17.00 x	—	55710	U	62.00 x	69.60 x	— x	7.30 x	—
56690	U001	60.00 x	100.00 x	— x	20.00 x	—	56716	U008	62.00 x	70.00 x	— x	8.00 x	—
56691	U002	60.00 x	100.00 x	— x	20.00 x	—	56717	U006	62.00 x	70.00 x	— x	11.80 x	—
—	CH	60.00 x	100.00 x	— x	47.00 x	—	56718	U019	62.00 x	71.00 x	— x	13.00 x	—
3154	C	60.00 x	101.60 x	— x	18.00 x	—	52400	U006	62.00 x	71.00 x	— x	15.00 x	—
56692	U001	60.00 x	105.00 x	— x	25.00 x	—	53438	U	62.00 x	71.80 x	— x	6.00 x	—
56693	U002	60.00 x	105.00 x	— x	25.00 x	—	56719	U004	62.00 x	72.00 x	— x	12.00 x	—
3424	C	60.00 x	125.00 x	— x	25.00 x	—	56720	U002	62.00 x	74.00 x	— x	8.00 x	—
3554	C	60.00 x	130.00 x	— x	27.00 x	—	50098	U011	62.00 x	74.00 x	— x	8.00 x	—
51339	U002	60.30 x	76.20 x	— x	7.50 x	—	56721	U005	62.00 x	74.00 x	— x	13.00 x	—
51029	U	60.30 x	79.30 x	— x	11.50 x	—	56722	U006	62.00 x	74.00 x	— x	13.00 x	—
51029	U004	60.30 x	79.30 x	— x	11.50 x	—	6387	CH	62.00 x	74.00 x	— x	30.00 x	—
F5768	W	60.30 x	79.37 x	— x	8.00 x	6.20	59399	UL	62.00 x	75.00 x	— x	5.00 x	9.00
52534	U	60.30 x	82.50 x	— x	14.00 x	—	55678	U006	62.00 x	75.00 x	— x	7.50 x	—



Cód	Mod	Di x	De x	Esp. x	Ha1 x	Ha2	Cód	Mod	Di x	De x	Esp. x	Ha1 x	Ha2
56723	U002	62.00 x	75.00 x	— x	11.50 x	—	56762	U002	63.00 x	82.00 x	— x	10.00 x	—
51179	U002	62.00 x	76.00 x	— x	8.00 x	—	56763	U007	63.00 x	82.00 x	— x	13.00 x	—
56724	U002	62.00 x	77.00 x	— x	8.00 x	—	51731	U	63.00 x	83.00 x	— x	15.00 x	—
56725	U002	62.00 x	78.00 x	— x	8.00 x	—	51731	U	63.00 x	83.00 x	— x	15.00 x	—
56726	U006	62.00 x	78.00 x	— x	8.00 x	—	56764	U004	63.00 x	83.00 x	— x	15.00 x	—
52257	U031	62.00 x	78.00 x	— x	8.00 x	—	—	CH	63.00 x	83.00 x	— x	45.00 x	—
50322	U006	62.00 x	81.00 x	— x	12.00 x	—	51687	U	63.00 x	85.00 x	— x	10.00 x	—
56727	U008	62.00 x	81.00 x	— x	12.00 x	—	8243	V	63.00 x	85.00 x	— x	14.80 x	—
56728	U002	62.00 x	82.00 x	— x	8.00 x	—	56765	U003	63.00 x	91.50 x	— x	15.00 x	—
56729	U001	62.00 x	82.00 x	— x	10.00 x	—	56766	U001	63.00 x	93.00 x	— x	15.00 x	—
56730	U002	62.00 x	82.00 x	— x	10.00 x	—	56767	U002	63.00 x	93.00 x	— x	15.00 x	—
56731	U001	62.00 x	82.00 x	— x	15.00 x	—	56768	U003	63.00 x	94.00 x	— x	15.00 x	—
56732	U002	62.00 x	82.00 x	— x	15.00 x	—	8187	V	63.10 x	78.58 x	— x	6.35 x	—
56733	U001	62.00 x	82.00 x	— x	18.00 x	—	6155	CH	63.10 x	78.58 x	— x	38.00 x	—
56734	U002	62.00 x	82.00 x	— x	18.00 x	—	56769	U002	63.50 x	73.00 x	— x	5.00 x	—
50893	U001	62.00 x	83.00 x	— x	14.50 x	—	50526	U024	63.50 x	73.02 x	— x	14.29 x	—
8013	V	62.00 x	84.00 x	— x	9.00 x	—	50115	U004	63.50 x	73.50 x	— x	6.00 x	—
56735	U001	62.00 x	85.00 x	— x	12.00 x	—	53322	U04A	63.50 x	73.50 x	— x	9.53 x	—
56736	U002	62.00 x	85.00 x	— x	12.00 x	—	51230	U	63.50 x	74.00 x	— x	5.70 x	—
56737	U001	62.00 x	86.00 x	— x	10.00 x	—	51135	U002	63.50 x	74.00 x	— x	5.70 x	—
56738	U002	62.00 x	86.00 x	— x	10.00 x	—	51135	U002	63.50 x	74.00 x	— x	5.70 x	—
56739	U001	62.00 x	86.00 x	— x	12.00 x	—	56770	U	63.50 x	74.50 x	— x	6.00 x	9.00
56740	U002	62.00 x	86.00 x	— x	12.00 x	—	51575	U002	63.50 x	74.50 x	— x	6.00 x	—
56741	U001	62.00 x	88.00 x	— x	12.00 x	—	51575	U002	63.50 x	74.50 x	— x	6.00 x	—
56742	U002	62.00 x	88.00 x	— x	12.00 x	—	50288	U021	63.50 x	74.50 x	— x	9.00 x	6.00
56743	U001	62.00 x	92.00 x	— x	8.00 x	—	56771	U005	63.50 x	75.00 x	— x	8.50 x	—
56744	U002	62.00 x	92.00 x	— x	8.00 x	—	55728	U	63.50 x	75.00 x	— x	9.00 x	—
56745	U001	62.00 x	92.00 x	— x	15.00 x	—	52004	UL	63.50 x	75.50 x	— x	9.00 x	—
56746	U002	62.00 x	92.00 x	— x	15.00 x	—	52004	UL	63.50 x	75.50 x	— x	9.00 x	—
52022	U	62.00 x	120.00 x	— x	27.00 x	—	52716	U	63.50 x	75.50 x	— x	9.50 x	—
3125	C	62.10 x	114.30 x	3.17 x	15.87 x	—	8204	V	63.50 x	76.10 x	— x	4.40 x	—
6225	CH	62.50 x	75.50 x	— x	29.00 x	—	59364	UL	63.50 x	76.10 x	— x	6.50 x	9.00
56747	U019	62.50 x	79.00 x	— x	12.70 x	—	59364	UL	63.50 x	76.10 x	— x	6.50 x	9.00
52155	U	62.50 x	82.50 x	— x	9.50 x	—	F889	W	63.50 x	76.20 x	— x	5.00 x	4.50
56748	U007	62.55 x	80.05 x	— x	16.20 x	—	8055	V	63.50 x	76.20 x	— x	5.56 x	—
52024	U	62.70 x	73.50 x	— x	7.00 x	—	52194	U04A	63.50 x	76.20 x	— x	6.35 x	—
50347	U070	62.71 x	79.37 x	— x	15.87 x	—	53329	U04A	63.50 x	76.20 x	— x	6.35 x	—
50419	U026	62.71 x	82.55 x	— x	8.73 x	—	59357	UL	63.50 x	76.20 x	— x	7.00 x	8.73
6090	CH	62.85 x	79.40 x	— x	38.10 x	—	56772	U005	63.50 x	76.20 x	— x	7.94 x	—
59366	UL	63.00 x	70.00 x	— x	2.50 x	4.00	56773	U006	63.50 x	76.20 x	— x	7.94 x	—
59366	UL	63.00 x	70.00 x	— x	2.50 x	4.00	51324	U	63.50 x	76.20 x	— x	9.50 x	—
51978	U031	63.00 x	71.00 x	— x	6.50 x	—	51324	U005	63.50 x	76.20 x	— x	9.52 x	—
56749	U019	63.00 x	71.00 x	— x	14.00 x	—	50544	U031	63.50 x	76.20 x	— x	9.52 x	—
50375	U004	63.00 x	72.00 x	— x	5.30 x	—	50544	U04A	63.50 x	76.20 x	— x	9.52 x	—
50375	U004	63.00 x	72.00 x	— x	5.40 x	—	6011	CH	63.50 x	76.20 x	— x	9.53 x	—
56750	U002	63.00 x	72.00 x	— x	5.50 x	—	56776	U	63.50 x	76.20 x	— x	10.32 x	—
56751	U031	63.00 x	73.00 x	— x	7.00 x	—	50107	U002	63.50 x	76.20 x	— x	10.32 x	—
56752	U007	63.00 x	73.00 x	— x	9.00 x	—	56777	U004	63.50 x	76.20 x	— x	10.32 x	—
56753	U008	63.00 x	73.00 x	— x	9.00 x	—	50381	U004	63.50 x	76.20 x	— x	10.66 x	—
56754	U005	63.00 x	73.00 x	— x	11.00 x	—	50381	U004	63.50 x	76.20 x	— x	10.66 x	—
56755	U006	63.00 x	73.00 x	— x	11.00 x	—	50096	U013	63.50 x	76.20 x	— x	12.70 x	—
53357	U	63.00 x	74.00 x	— x	7.00 x	—	50096	U013	63.50 x	76.20 x	— x	12.70 x	—
52020	U002	63.00 x	75.00 x	— x	8.50 x	—	50096	U013	63.50 x	76.20 x	— x	12.70 x	—
59430	U019	63.00 x	75.00 x	— x	10.50 x	—	—	CH	63.50 x	76.20 x	— x	28.00 x	—
50551	UL	63.00 x	76.00 x	— x	9.00 x	—	—	CH	63.50 x	76.20 x	— x	34.50 x	—
56756	U	63.00 x	76.20 x	— x	7.00 x	8.00	6314	CH	63.50 x	77.00 x	— x	30.00 x	—
50301	U062	63.00 x	76.20 x	— x	8.00 x	7.00	—	CH	63.50 x	77.79 x	— x	28.00 x	—
56757	U003	63.00 x	77.50 x	— x	14.00 x	—	52431	U	63.50 x	79.00 x	— x	8.00 x	—
51419	U	63.00 x	78.00 x	— x	10.00 x	—	8035	V	63.50 x	79.37 x	— x	—	—
56758	U001	63.00 x	78.00 x	— x	14.00 x	—	8097	V	63.50 x	79.37 x	— x	8.00 x	—
56759	U002	63.00 x	78.00 x	— x	14.00 x	—	51417	U	63.50 x	79.37 x	— x	12.70 x	—
56760	U002	63.00 x	78.00 x	— x	14.00 x	—	51417	U	63.50 x	79.37 x	— x	12.70 x	—
—	CH	63.00 x	78.50 x	— x	25.00 x	—	51481	U002	63.50 x	79.37 x	— x	12.70 x	—
53124	U04A	63.00 x	80.00 x	— x	16.00 x	—	53350	U04A	63.50 x	79.38 x	— x	6.35 x	—
6329	CH	63.00 x	80.00 x	— x	40.00 x	—	—	U04A	63.50 x	79.38 x	— x	7.93 x	—
8305	V	63.00 x	81.50 x	— x	7.00 x	—	6020	CH	63.50 x	79.38 x	— x	38.10 x	—
56761	U001	63.00 x	82.00 x	— x	10.00 x	—	6020	CH	63.50 x	79.38 x	— x	38.10 x	—





Cód	Mod	Di x	De x	Esp. x	Ha1 x	Ha2	Cód	Mod	Di x	De x	Esp. x	Ha1 x	Ha2
—	CH	63.50 x	79.50 x	— x	27.00 x	—	56793	U002	64.00 x	82.00 x	— x	10.00 x	—
52745	U	63.50 x	80.00 x	— x	10.00 x	—	—	CH	64.00 x	82.00 x	— x	36.50 x	—
—	CH	63.50 x	80.00 x	— x	26.50 x	—	52277	U	64.00 x	82.50 x	— x	9.50 x	—
—	CH	63.50 x	80.00 x	— x	53.00 x	—	56794	U002	64.00 x	82.50 x	— x	10.00 x	—
50205	U004	63.50 x	80.90 x	— x	11.10 x	—	56795	U019	64.00 x	83.00 x	— x	9.50 x	—
53096	U04A	63.50 x	80.90 x	— x	11.10 x	—	56796	U003	64.00 x	83.00 x	— x	12.00 x	—
53096	U04A	63.50 x	80.90 x	— x	11.10 x	—	50305	U031	64.00 x	84.00 x	— x	10.50 x	—
50866	U	63.50 x	80.96 x	— x	9.52 x	—	8052	V	64.00 x	85.00 x	— x	9.00 x	—
F13852	W	63.50 x	82.00 x	— x	8.00 x	9.60	55619	U	64.00 x	89.00 x	— x	12.00 x	—
52810	U	63.50 x	82.50 x	— x	9.50 x	—	56797	U001	64.00 x	90.00 x	— x	12.00 x	—
52961	U019	63.50 x	82.50 x	— x	9.50 x	—	56798	U002	64.00 x	90.00 x	— x	12.00 x	—
8304	V	63.50 x	82.55 x	— x	7.93 x	—	56799	U003	64.00 x	90.00 x	— x	12.00 x	—
50354	U081	63.50 x	82.55 x	— x	8.73 x	—	6430	CH	64.00 x	94.00 x	— x	30.00 x	—
8105	V	63.50 x	82.55 x	— x	9.00 x	—	53372	U004	64.20 x	79.00 x	— x	6.00 x	—
52961	U	63.50 x	82.55 x	— x	9.50 x	—	59351	UL	64.50 x	76.30 x	— x	7.00 x	9.50
56778	U002	63.50 x	82.55 x	— x	9.53 x	—	56800	U	64.50 x	80.00 x	— x	6.30 x	—
56779	U019	63.50 x	82.55 x	— x	9.53 x	—	55648	U04A	64.50 x	80.00 x	— x	6.30 x	—
51962	U005	63.50 x	82.55 x	— x	11.91 x	—	56801	U004	65.00 x	72.00 x	— x	5.00 x	—
53156	U	63.50 x	82.55 x	— x	12.00 x	—	50371	U031	65.00 x	73.00 x	— x	14.00 x	—
52551	U	63.50 x	82.55 x	— x	14.00 x	—	59427	U002	65.00 x	74.00 x	— x	5.00 x	—
56780	U007	63.50 x	82.55 x	— x	14.29 x	—	56802	U002	65.00 x	75.00 x	— x	5.00 x	—
—	U04A	63.50 x	82.55 x	— x	15.87 x	—	59372	UL	65.00 x	75.00 x	— x	7.00 x	12.00
6046	CH	63.50 x	82.55 x	— x	31.75 x	—	52804	U	65.00 x	75.00 x	— x	8.00 x	—
—	CH	63.50 x	83.00 x	— x	37.50 x	—	52856	U	65.00 x	75.00 x	— x	8.00 x	—
—	CH	63.50 x	83.50 x	— x	36.00 x	—	56804	U005	65.00 x	75.00 x	— x	8.00 x	—
—	CH	63.50 x	83.50 x	— x	54.00 x	—	52856	U031	65.00 x	75.00 x	— x	8.00 x	—
—	CH	63.50 x	84.14 x	— x	33.00 x	—	53034	U	65.00 x	75.00 x	— x	12.00 x	—
56781	U002	63.50 x	88.50 x	— x	14.00 x	—	51193	U004	65.00 x	75.00 x	— x	12.00 x	—
—	CH	63.50 x	88.50 x	— x	47.00 x	—	55601	U004	65.00 x	75.00 x	— x	12.00 x	—
53159	U001	63.50 x	88.90 x	— x	12.70 x	—	53034	U006	65.00 x	75.00 x	— x	12.00 x	—
59278	U006	63.50 x	88.90 x	— x	14.50 x	16.50	56805	U007	65.00 x	75.00 x	— x	12.00 x	—
6296	CH	63.50 x	88.90 x	— x	28.60 x	—	56806	U008	65.00 x	75.00 x	— x	12.00 x	—
52077	U	63.50 x	90.00 x	— x	15.00 x	—	56807	U005	65.00 x	75.00 x	— x	13.50 x	—
3365	C	63.50 x	92.50 x	17.50 x	89.50 x	—	56808	U006	65.00 x	75.00 x	— x	13.50 x	—
3238	C	63.50 x	100.00 x	3.00 x	11.00 x	—	56809	U007	65.00 x	75.00 x	— x	13.50 x	—
3120	C	63.50 x	100.01 x	4.76 x	22.22 x	—	56810	U008	65.00 x	75.00 x	— x	13.50 x	—
3101	C	63.50 x	101.60 x	5.00 x	15.87 x	—	50597	U002	65.00 x	75.20 x	— x	5.50 x	—
3232	C	63.50 x	127.50 x	3.50 x	16.00 x	—	—	U004	65.00 x	76.00 x	— x	5.50 x	—
3288	C	63.50 x	129.00 x	— x	16.00 x	—	52547	U002	65.00 x	76.00 x	— x	6.50 x	—
52709	U007	63.60 x	79.00 x	— x	11.00 x	—	56811	U007	65.00 x	76.00 x	— x	7.50 x	—
6168	CH	63.70 x	76.10 x	— x	26.40 x	—	3352	C	65.00 x	76.00 x	4.00 x	8.50 x	—
8244	V	63.80 x	85.20 x	— x	14.80 x	—	51184	U007	65.00 x	77.00 x	— x	6.00 x	5.50
56782	U031	63.90 x	82.55 x	— x	7.94 x	—	51184	U007	65.00 x	77.00 x	— x	6.00 x	—
—	CH	63.90 x	88.90 x	— x	32.00 x	—	50620	U004	65.00 x	77.00 x	— x	8.00 x	—
51540	U031	64.00 x	70.00 x	— x	6.50 x	—	56812	U008	65.00 x	79.00 x	— x	17.50 x	—
56783	U002	64.00 x	74.00 x	— x	6.00 x	—	52115	U001	65.00 x	80.00 x	— x	7.50 x	—
56784	U001	64.00 x	74.00 x	— x	7.00 x	—	51557	U002	65.00 x	80.00 x	— x	8.00 x	—
8365	V	64.00 x	74.00 x	— x	7.00 x	—	56813	U004	65.00 x	80.00 x	— x	8.00 x	—
56785	U005	64.00 x	74.00 x	— x	10.50 x	—	50363	U005	65.00 x	80.00 x	— x	8.00 x	—
56786	U006	64.00 x	74.00 x	— x	10.50 x	—	50363	U005	65.00 x	80.00 x	— x	8.00 x	—
50736	U005	64.00 x	75.00 x	— x	8.00 x	—	8285	V	65.00 x	80.00 x	— x	8.50 x	—
50736	U005	64.00 x	75.00 x	— x	8.00 x	7.00	56814	U001	65.00 x	80.00 x	— x	11.00 x	—
56787	U002	64.00 x	75.00 x	— x	16.00 x	—	56815	U002	65.00 x	80.00 x	— x	11.00 x	—
53264	UL	64.00 x	76.00 x	— x	7.00 x	—	3532	C	65.00 x	80.00 x	— x	12.00 x	—
53264	UL	64.00 x	76.00 x	— x	9.00 x	—	52891	U	65.00 x	80.00 x	— x	12.00 x	—
8205	V	64.00 x	77.00 x	— x	6.50 x	—	56816	U002	65.00 x	80.00 x	— x	12.00 x	—
52327	U002	64.00 x	78.00 x	— x	8.00 x	—	51040	U004	65.00 x	80.00 x	— x	12.00 x	—
55730	U	64.00 x	78.00 x	— x	10.00 x	—	51040	U004	65.00 x	80.00 x	— x	12.00 x	—
8201	V	64.00 x	79.50 x	— x	5.00 x	—	6188	CH	65.00 x	80.00 x	— x	32.00 x	—
56788	U001	64.00 x	80.00 x	— x	8.00 x	—	56818	U004	65.00 x	81.00 x	— x	11.00 x	—
50525	U002	64.00 x	80.00 x	— x	8.00 x	—	8307	V	65.00 x	81.20 x	— x	7.50 x	—
56789	U002	64.00 x	80.00 x	— x	8.00 x	—	8379	V	65.00 x	82.00 x	— x	9.00 x	—
52791	U	64.00 x	80.00 x	— x	10.00 x	—	56819	U004	65.00 x	82.00 x	— x	12.00 x	—
56790	U001	64.00 x	80.00 x	— x	12.00 x	—	52989	U	65.00 x	83.00 x	— x	10.00 x	—
56791	U002	64.00 x	80.00 x	— x	12.00 x	—	52989	U002	65.00 x	83.00 x	— x	10.00 x	—
50550	U069	64.00 x	80.00 x	— x	12.00 x	—	52085	U004	65.00 x	85.00 x	— x	9.35 x	—
50803	U002	64.00 x	82.00 x	— x	9.50 x	—	50247	U003	65.00 x	85.00 x	— x	10.00 x	—



Cód	Mod	Di x	De x	Esp. x	Ha1 x	Ha2	Cód	Mod	Di x	De x	Esp. x	Ha1 x	Ha2
56820	U003	65.00 x	85.00 x	— x	10.00 x	—	8044	V	66.67 x	85.72 x	— x	7.94 x	—
56821	U004	65.00 x	85.00 x	— x	10.00 x	—	51882	U	66.68 x	79.38 x	— x	6.35 x	—
56822	U019	65.00 x	85.00 x	— x	10.00 x	—	52781	U008	66.68 x	79.38 x	— x	6.35 x	—
50023	U001	65.00 x	85.00 x	— x	12.00 x	—	—	U04A	66.68 x	79.38 x	— x	9.52 x	—
50023	U001	65.00 x	85.00 x	— x	12.00 x	—	56859	U019	66.68 x	82.55 x	— x	7.94 x	—
56823	U002	65.00 x	85.00 x	— x	12.00 x	—	56860	U004	66.68 x	82.55 x	— x	15.88 x	—
F8325	ESPE	65.00 x	85.00 x	— x	13.50 x	—	52898	U04A	66.68 x	85.70 x	— x	15.80 x	—
56824	U001	65.00 x	85.00 x	— x	18.00 x	—	52692	U	66.68 x	85.73 x	— x	9.53 x	—
56825	U002	65.00 x	85.00 x	— x	18.00 x	—	52692	U04A	66.68 x	85.73 x	— x	9.53 x	—
6196	CH	65.00 x	85.00 x	— x	35.00 x	—	52898	U	66.68 x	85.73 x	— x	15.80 x	—
—	CH	65.00 x	85.00 x	— x	46.00 x	—	—	CH	66.68 x	85.73 x	— x	37.00 x	—
56826	U	65.00 x	88.00 x	— x	8.00 x	10.00	50584	U007	67.00 x	77.50 x	— x	7.00 x	—
50034	U017	65.00 x	88.00 x	— x	10.00 x	—	51677	U	67.00 x	78.00 x	7.50 x	8.30 x	—
50034	U017	65.00 x	88.00 x	— x	10.00 x	8.00	51189	U	67.00 x	78.00 x	— x	12.00 x	—
F7032	J	65.00 x	90.00 x	— x	12.00 x	2.00	52479	U031	67.00 x	79.00 x	— x	9.50 x	—
56827	U002	65.00 x	90.00 x	— x	12.00 x	—	56861	U031	67.00 x	79.00 x	— x	9.50 x	—
56828	U019	65.00 x	90.00 x	— x	12.00 x	—	56862	U008	67.00 x	80.00 x	— x	8.00 x	—
56829	U002	65.00 x	90.00 x	— x	15.00 x	—	51406	U	67.00 x	80.00 x	— x	10.00 x	—
56830	U001	65.00 x	90.00 x	— x	18.00 x	—	53304	U	67.00 x	82.00 x	— x	7.50 x	—
56831	U002	65.00 x	90.00 x	— x	18.00 x	—	56863	U002	67.00 x	82.00 x	— x	7.50 x	—
56832	U001	65.00 x	93.00 x	— x	12.00 x	—	53304	U002	67.00 x	82.00 x	— x	8.00 x	—
56833	U002	65.00 x	93.00 x	— x	12.00 x	—	50280	U002	67.00 x	85.00 x	— x	10.00 x	—
56834	U001	65.00 x	95.00 x	— x	12.00 x	—	50831	U059	67.00 x	86.00 x	— x	12.00 x	—
56835	U002	65.00 x	95.00 x	— x	12.00 x	—	56864	U004	67.00 x	87.00 x	— x	12.00 x	—
56836	U019	65.00 x	95.00 x	— x	12.00 x	—	—	CH	67.00 x	87.00 x	— x	46.00 x	—
56837	U001	65.00 x	95.00 x	— x	15.00 x	—	56865	U002	67.00 x	90.00 x	— x	12.00 x	—
56838	U002	65.00 x	95.00 x	— x	15.00 x	—	53503	U002	67.00 x	94.00 x	— x	7.00 x	—
56839	U004	65.00 x	95.00 x	— x	15.00 x	—	52485	U044	67.50 x	77.50 x	— x	15.00 x	—
51007	U005	65.00 x	95.00 x	— x	20.00 x	16.00	56866	U001	67.50 x	80.00 x	— x	8.00 x	—
56840	U001	65.00 x	97.00 x	— x	15.00 x	—	56866	U001	67.50 x	80.00 x	— x	8.00 x	—
56841	U002	65.00 x	97.00 x	— x	15.00 x	—	—	CH	67.50 x	94.50 x	— x	37.10 x	—
6237	CH	65.00 x	97.00 x	— x	52.00 x	—	51620	U	68.00 x	75.00 x	— x	13.00 x	—
56842	U002	65.00 x	100.00 x	— x	13.00 x	—	56867	U001	68.00 x	78.00 x	— x	10.00 x	—
56843	U001	65.00 x	100.00 x	— x	18.00 x	—	56868	U002	68.00 x	78.00 x	— x	10.00 x	—
56844	U002	65.00 x	100.00 x	— x	18.00 x	—	56869	U003	68.00 x	78.00 x	— x	10.00 x	—
—	CH	65.00 x	100.00 x	— x	48.00 x	—	56870	U006	68.00 x	78.00 x	— x	13.00 x	—
56845	U001	65.00 x	102.00 x	— x	20.00 x	—	56871	U002	68.00 x	80.00 x	— x	6.00 x	—
56846	U002	65.00 x	102.00 x	— x	20.00 x	—	53215	U002	68.00 x	80.00 x	— x	6.00 x	—
6083	CH	65.00 x	102.00 x	— x	60.00 x	—	52984	U	68.00 x	80.00 x	— x	8.00 x	—
56847	U001	65.00 x	105.00 x	— x	25.00 x	—	52984	U	68.00 x	80.00 x	— x	8.00 x	—
56848	U002	65.00 x	105.00 x	— x	25.00 x	—	52662	U001	68.00 x	80.00 x	— x	8.00 x	—
56849	U001	65.00 x	106.00 x	— x	25.00 x	—	51677	U028	68.00 x	80.00 x	— x	8.00 x	5.00
56850	U002	65.00 x	106.00 x	— x	25.00 x	—	52304	U	68.00 x	80.00 x	— x	9.50 x	5.00
6273	CH	65.00 x	110.00 x	— x	42.50 x	—	52304	U007	68.00 x	80.00 x	— x	9.50 x	—
51360	U026	65.00 x	120.00 x	— x	27.00 x	—	56872	U001	68.00 x	80.00 x	— x	12.00 x	—
3553	C	65.00 x	285.40 x	— x	15.00 x	—	56873	U002	68.00 x	80.00 x	— x	12.00 x	—
56851	U002	65.09 x	76.20 x	— x	6.35 x	—	56874	U006	68.00 x	82.00 x	— x	7.00 x	—
8098	V	65.09 x	80.96 x	— x	8.20 x	—	52880	U049	68.00 x	88.50 x	— x	20.20 x	—
6077	CH	65.09 x	80.96 x	— x	33.34 x	—	53191	U	68.00 x	88.70 x	— x	13.70 x	—
3472	C	65.30 x	200.00 x	— x	38.00 x	—	8350	V	68.00 x	90.00 x	— x	10.00 x	—
56852	U002	65.50 x	75.00 x	— x	5.80 x	—	51678	U002	68.00 x	90.00 x	— x	11.00 x	—
—	CH	65.50 x	80.00 x	— x	38.00 x	—	56875	U002	68.00 x	90.00 x	— x	11.00 x	—
56853	U019	65.50 x	81.00 x	— x	10.00 x	—	56876	U004	68.00 x	90.00 x	— x	11.00 x	—
50412	U002	66.00 x	75.00 x	— x	5.50 x	—	56877	U031	68.00 x	90.00 x	— x	12.00 x	—
56854	U001	66.00 x	76.00 x	— x	10.00 x	—	56878	U001	68.00 x	90.00 x	— x	18.00 x	—
56855	U002	66.00 x	76.00 x	— x	10.00 x	—	56879	U002	68.00 x	90.00 x	— x	18.00 x	—
56856	U005	66.00 x	77.00 x	— x	9.00 x	—	56880	U001	68.00 x	92.00 x	— x	12.00 x	—
8252	V	66.00 x	79.00 x	— x	6.50 x	—	56881	U002	68.00 x	92.00 x	— x	12.00 x	—
56857	U002	66.00 x	79.00 x	— x	8.00 x	—	53258	U	68.00 x	92.00 x	— x	15.00 x	—
—	CH	66.00 x	81.00 x	— x	37.50 x	—	56882	U004	68.00 x	92.00 x	— x	15.00 x	—
50424	U019	66.00 x	82.00 x	— x	10.00 x	—	3048	C	68.00 x	100.00 x	4.00 x	16.00 x	—
56858	U001	66.00 x	96.00 x	— x	15.00 x	—	56883	U019	68.00 x	108.00 x	— x	19.00 x	—
6222	CH	66.40 x	90.00 x	— x	42.00 x	—	56884	U001	68.00 x	115.00 x	— x	20.00 x	—
59425	U001	66.50 x	80.00 x	6.50 x	—	—	56885	U002	68.00 x	115.00 x	— x	20.00 x	—
50373	U002	66.50 x	80.50 x	— x	9.00 x	—	53389	U002	68.20 x	87.80 x	— x	15.30 x	—
50373	U002	66.50 x	80.50 x	— x	9.00 x	—	—	CH	68.26 x	87.31 x	— x	35.00 x	—
50427	U004	66.67 x	79.37 x	— x	11.91 x	—	56886	U004	68.26 x	91.28 x	— x	15.08 x	—



Cód	Mod	Di x	De x	Esp. x	Ha1 x	Ha2	Cód	Mod	Di x	De x	Esp. x	Ha1 x	Ha2
3186	C001	68.26 x	103.98 x	5.00 x	11.90 x	—	56907	U005	70.00 x	78.00 x	— x	13.50 x	—
52890	U04A	68.50 x	86.50 x	— x	9.50 x	—	56909	U006	70.00 x	78.00 x	— x	13.50 x	—
3144	C	68.50 x	110.00 x	— x	9.50 x	—	56910	U005	70.00 x	79.00 x	— x	14.00 x	—
56887	U004	68.85 x	82.14 x	— x	9.53 x	—	56911	U006	70.00 x	79.00 x	— x	14.00 x	—
56888	U002	69.00 x	78.00 x	— x	12.00 x	—	51850	U012	70.00 x	80.00 x	— x	5.00 x	—
56889	U004	69.00 x	78.50 x	— x	6.30 x	—	F13550	W	70.00 x	80.00 x	— x	5.70 x	—
50700	U031	69.00 x	79.00 x	— x	5.00 x	—	56912	U002	70.00 x	80.00 x	— x	6.00 x	—
52152	U	69.00 x	81.00 x	— x	10.50 x	—	50930	U	70.00 x	80.00 x	— x	7.00 x	6.00
52169	U004	69.00 x	83.00 x	— x	10.50 x	—	50930	U	70.00 x	80.00 x	— x	7.00 x	—
56890	U003	69.00 x	85.00 x	— x	9.00 x	—	52360	U	70.00 x	80.00 x	— x	8.50 x	—
8229	V	69.00 x	85.00 x	— x	12.40 x	—	52360	U019	70.00 x	80.00 x	— x	8.50 x	—
56891	U001	69.00 x	93.00 x	— x	10.00 x	—	3272	C	70.00 x	80.00 x	— x	10.00 x	—
56892	U002	69.00 x	93.00 x	— x	10.00 x	—	56913	U003	70.00 x	80.00 x	— x	10.00 x	—
56893	U003	69.00 x	93.00 x	— x	10.00 x	—	50052	U004	70.00 x	80.00 x	— x	12.00 x	—
—	CH	69.00 x	94.00 x	— x	35.50 x	—	50052	U004	70.00 x	80.00 x	— x	12.00 x	—
50216	U072	69.00 x	95.00 x	— x	16.00 x	—	50052	U004	70.00 x	80.00 x	— x	12.00 x	—
—	CH	69.00 x	95.00 x	— x	52.00 x	—	56914	U007	70.00 x	80.00 x	— x	12.00 x	—
3068	C	69.00 x	136.00 x	5.50 x	26.00 x	—	56915	U008	70.00 x	80.00 x	— x	12.00 x	—
8024	V	69.50 x	84.00 x	— x	6.00 x	5.00	50193	U077	70.00 x	80.00 x	— x	13.00 x	—
56894	U005	69.50 x	85.00 x	— x	12.00 x	—	56916	U003	70.00 x	80.00 x	— x	14.00 x	—
56895	U005	69.50 x	88.00 x	— x	9.00 x	—	56917	U007	70.00 x	81.00 x	— x	9.00 x	—
—	CH	69.50 x	88.50 x	— x	44.50 x	—	56918	U001	70.00 x	81.00 x	— x	15.00 x	—
50631	U002	69.80 x	88.20 x	— x	10.00 x	—	56919	U002	70.00 x	81.00 x	— x	15.00 x	—
50631	U002	69.80 x	88.20 x	— x	10.00 x	—	51401	U006	70.00 x	82.00 x	— x	8.00 x	—
3235	C	69.80 x	103.00 x	4.00 x	13.00 x	—	56920	U006	70.00 x	82.00 x	— x	8.00 x	—
56896	U005	69.85 x	77.79 x	— x	13.49 x	—	52644	U006	70.00 x	82.00 x	— x	8.50 x	—
56898	U006	69.85 x	77.79 x	— x	13.49 x	—	51116	U	70.00 x	82.00 x	— x	9.00 x	7.00
52005	U	69.85 x	82.55 x	— x	6.35 x	—	52149	U003	70.00 x	82.00 x	— x	9.00 x	—
52005	U	69.85 x	82.55 x	— x	6.35 x	—	55647	U04A	70.00 x	82.00 x	— x	10.00 x	—
52005	U04A	69.85 x	82.55 x	— x	6.35 x	—	56921	U001	70.00 x	82.00 x	— x	12.00 x	—
8399	V	69.85 x	82.68 x	— x	7.92 x	—	56922	U002	70.00 x	82.00 x	— x	12.00 x	—
59340	U04A	69.85 x	85.70 x	— x	12.70 x	—	—	CH	70.00 x	82.50 x	— x	42.00 x	—
—	U04A	69.85 x	85.73 x	— x	7.93 x	—	50925	U	70.00 x	83.00 x	— x	8.00 x	—
56899	U031	69.85 x	88.90 x	— x	7.94 x	—	55706	U04A	70.00 x	83.00 x	— x	9.00 x	—
52043	U019	69.85 x	88.90 x	— x	9.53 x	—	52735	U002	70.00 x	84.00 x	— x	6.50 x	—
8261	V	69.85 x	88.90 x	— x	9.53 x	—	52840	U004	70.00 x	84.00 x	— x	12.00 x	—
56900	U002	69.85 x	88.90 x	— x	10.70 x	—	52840	U04A	70.00 x	84.00 x	— x	12.00 x	—
52895	U	69.85 x	88.90 x	— x	10.72 x	—	52840	U04A	70.00 x	84.00 x	— x	12.00 x	—
52895	U001	69.85 x	88.90 x	— x	10.72 x	—	56924	U001	70.00 x	85.00 x	— x	7.50 x	—
56901	U004	69.85 x	88.90 x	— x	11.91 x	—	56925	U002	70.00 x	85.00 x	— x	7.50 x	—
6008	CH	69.85 x	88.90 x	— x	14.29 x	—	53390	U	70.00 x	85.00 x	— x	10.00 x	—
—	U04A	69.85 x	88.90 x	— x	15.87 x	—	53390	U04A	70.00 x	85.00 x	— x	10.00 x	—
6038	CH	69.85 x	88.90 x	— x	26.19 x	—	53390	U04A	70.00 x	85.00 x	— x	10.00 x	—
56902	U019	69.85 x	95.25 x	— x	9.53 x	—	51742	U	70.00 x	85.00 x	— x	10.50 x	—
—	U04A	69.85 x	95.25 x	— x	19.05 x	—	51742	U004	70.00 x	85.00 x	— x	10.50 x	—
—	CH	69.85 x	95.25 x	— x	43.00 x	—	56926	U001	70.00 x	85.00 x	— x	11.00 x	—
6205	CH	69.85 x	95.25 x	— x	50.80 x	—	56927	U002	70.00 x	85.00 x	— x	11.00 x	—
53123	U04A	69.85 x	101.60 x	— x	21.00 x	—	8381	V	70.00 x	85.00 x	— x	11.00 x	—
53083	U002	69.85 x	101.60 x	— x	27.00 x	—	56928	U002	70.00 x	85.00 x	— x	12.00 x	—
53083	U002	69.85 x	101.60 x	— x	27.00 x	—	56929	U002	70.00 x	85.00 x	— x	12.00 x	—
6111	CH	69.85 x	101.60 x	— x	59.13 x	—	52091	U004	70.00 x	85.00 x	— x	12.00 x	—
52059	U028	69.90 x	89.00 x	— x	12.70 x	—	56930	U007	70.00 x	85.00 x	— x	12.00 x	—
50721	U	69.95 x	82.55 x	— x	9.52 x	—	56931	U008	70.00 x	85.00 x	— x	12.00 x	—
8106	V	69.95 x	88.90 x	— x	7.00 x	—	50084	UL	70.00 x	85.00 x	— x	12.00 x	—
8125	V	69.95 x	88.90 x	— x	8.60 x	—	56932	U003	70.00 x	85.00 x	— x	14.00 x	—
8124	V	69.95 x	88.90 x	— x	8.60 x	—	56933	U001	70.00 x	85.00 x	— x	15.00 x	—
3066	C	69.95 x	98.42 x	4.00 x	12.70 x	—	50545	U002	70.00 x	85.00 x	— x	15.00 x	—
8154	V	69.95 x	101.60 x	— x	11.11 x	—	6199	CH	70.00 x	85.00 x	— x	20.00 x	—
3100	C	69.95 x	120.65 x	6.00 x	19.05 x	—	6075	CH	70.00 x	85.00 x	— x	23.00 x	—
3077	C	69.95 x	127.00 x	5.00 x	22.22 x	—	—	CH	70.00 x	85.00 x	— x	26.50 x	—
3077	C	69.95 x	127.00 x	— x	22.22 x	—	56934	U001	70.00 x	88.00 x	— x	10.00 x	—
59395	UL	70.00 x	78.00 x	2.10 x	3.80 x	8.00	56935	U002	70.00 x	88.00 x	— x	10.00 x	—
56903	U031	70.00 x	78.00 x	— x	6.50 x	—	56936	U002	70.00 x	88.00 x	— x	15.00 x	—
52675	U	70.00 x	78.00 x	— x	9.50 x	—	8230	V	70.00 x	88.90 x	— x	8.00 x	—
52675	U004	70.00 x	78.00 x	— x	9.50 x	—	6187	CH	70.00 x	88.90 x	— x	42.86 x	—
56904	U005	70.00 x	78.00 x	— x	12.00 x	—	—	CH	70.00 x	89.00 x	— x	41.00 x	—
56906	U006	70.00 x	78.00 x	— x	12.00 x	—	50184	U010	70.00 x	90.00 x	— x	7.50 x	—



Cód	Mod	Di x	De x	Esp. x	Ha1 x	Ha2	Cód	Mod	Di x	De x	Esp. x	Ha1 x	Ha2
51945	U	70.00 x	90.00 x	— x	10.00 x	—	56966	U002	71.75 x	82.55 x	— x	5.56 x	—
56937	U001	70.00 x	90.00 x	— x	10.00 x	—	53336	U002	72.00 x	80.00 x	— x	6.00 x	—
56938	U002	70.00 x	90.00 x	— x	10.00 x	—	56967	U007	72.00 x	80.00 x	— x	12.00 x	—
56939	U019	70.00 x	90.00 x	— x	10.00 x	—	56968	U008	72.00 x	80.00 x	— x	12.00 x	—
50241	U073	70.00 x	90.00 x	— x	10.00 x	—	56969	U002	72.00 x	81.00 x	— x	5.50 x	—
51089	U	70.00 x	90.00 x	— x	12.00 x	—	56970	U002	72.00 x	81.00 x	— x	6.00 x	—
51622	U002	70.00 x	90.00 x	— x	12.00 x	—	52719	U04A	72.00 x	82.00 x	— x	5.70 x	—
51622	U002	70.00 x	90.00 x	— x	12.00 x	—	52719	U04A	72.00 x	82.00 x	— x	5.70 x	—
56940	U002	70.00 x	90.00 x	— x	12.00 x	—	50693	U031	72.00 x	82.00 x	— x	7.50 x	—
51836	U002	70.00 x	90.00 x	— x	12.00 x	—	8357	V	72.00 x	82.00 x	— x	7.50 x	—
56941	U004	70.00 x	90.00 x	— x	12.00 x	—	56971	U005	72.00 x	82.00 x	— x	8.50 x	—
56941	U004	70.00 x	90.00 x	— x	12.00 x	—	51004	U	72.00 x	82.00 x	— x	12.00 x	—
50324	U046	70.00 x	90.00 x	— x	12.00 x	—	56972	U007	72.00 x	82.00 x	— x	12.00 x	—
50324	U046	70.00 x	90.00 x	— x	12.00 x	—	56973	U008	72.00 x	82.00 x	— x	12.00 x	—
8136	V	70.00 x	90.00 x	— x	12.00 x	—	56974	U031	72.00 x	83.00 x	— x	9.00 x	—
50655	U004	70.00 x	90.00 x	— x	12.50 x	—	56975	U002	72.00 x	83.20 x	— x	6.30 x	—
50655	U004	70.00 x	90.00 x	— x	12.50 x	—	50941	U031	72.00 x	83.20 x	— x	6.30 x	—
56942	U003	70.00 x	90.00 x	— x	13.00 x	—	51490	U	72.00 x	84.00 x	— x	6.00 x	—
51571	U	70.00 x	90.00 x	— x	13.50 x	—	56976	U002	72.00 x	84.00 x	— x	6.00 x	—
56943	U001	70.00 x	90.00 x	— x	18.00 x	—	53440	U002	72.00 x	84.00 x	— x	9.00 x	—
56944	U002	70.00 x	90.00 x	— x	18.00 x	—	56977	U002	72.00 x	84.00 x	— x	9.00 x	—
50137	U047	70.00 x	90.00 x	— x	18.00 x	—	56978	U005	72.00 x	85.00 x	— x	6.50 x	—
50428	U047	70.00 x	90.00 x	— x	18.00 x	—	50259	U025	72.00 x	85.00 x	— x	7.00 x	—
6101	CH	70.00 x	90.00 x	— x	40.00 x	—	50213	U002	72.00 x	85.00 x	— x	10.00 x	—
6101	CH	70.00 x	90.00 x	— x	40.00 x	—	56979	U001	72.00 x	86.00 x	— x	7.00 x	—
53182	U	70.00 x	92.00 x	— x	11.00 x	—	56980	U007	72.00 x	87.00 x	— x	12.00 x	—
53184	U002	70.00 x	92.00 x	— x	11.00 x	—	56981	U008	72.00 x	87.00 x	— x	12.00 x	—
8326	V	70.00 x	94.00 x	— x	6.50 x	—	8231	V	72.00 x	87.00 x	— x	12.50 x	—
8314	V	70.00 x	94.00 x	— x	12.00 x	—	56982	U	72.00 x	87.00 x	— x	24.00 x	—
56945	U001	70.00 x	95.00 x	— x	12.00 x	—	56983	U001	72.00 x	88.00 x	— x	8.00 x	—
56946	U002	70.00 x	95.00 x	— x	12.00 x	—	56984	U002	72.00 x	88.00 x	— x	8.00 x	—
50064	U026	70.00 x	95.00 x	— x	16.00 x	—	56985	U001	72.00 x	88.00 x	— x	15.00 x	—
—	CH	70.00 x	95.00 x	— x	58.00 x	—	56986	U007	72.00 x	90.00 x	— x	8.50 x	—
56947	U002	70.00 x	98.00 x	— x	14.00 x	—	56987	U001	72.00 x	92.00 x	— x	18.00 x	—
53131	U	70.00 x	100.00 x	— x	15.00 x	—	56988	U002	72.00 x	92.00 x	— x	18.00 x	—
56948	U002	70.00 x	100.00 x	— x	15.00 x	—	51469	U002	72.00 x	95.00 x	— x	12.00 x	—
3273	C	70.00 x	107.00 x	— x	10.00 x	—	8262	V	72.00 x	95.00 x	— x	12.00 x	—
56949	U001	70.00 x	110.00 x	— x	20.00 x	—	56989	U001	72.00 x	96.00 x	— x	12.00 x	—
56950	U002	70.00 x	110.00 x	— x	20.00 x	—	56990	U002	72.00 x	96.00 x	— x	12.00 x	—
3139	C	70.00 x	115.00 x	— x	12.00 x	—	56991	U001	72.00 x	102.00 x	— x	15.00 x	—
3075	C	70.00 x	123.00 x	6.00 x	21.00 x	—	53139	U	72.00 x	103.50 x	— x	15.00 x	—
3134	C	70.00 x	130.00 x	— x	12.70 x	—	56992	U001	72.00 x	105.00 x	— x	15.00 x	—
56951	U002	70.20 x	81.50 x	— x	6.00 x	—	56993	U002	72.00 x	105.00 x	— x	15.00 x	—
56952	U002	70.25 x	85.73 x	— x	15.30 x	—	3277	C	72.00 x	105.00 x	— x	18.00 x	—
3516	C	70.50 x	116.00 x	— x	20.00 x	—	56994	U001	72.00 x	122.00 x	— x	25.00 x	—
51372	U078	70.90 x	80.00 x	— x	6.00 x	—	56995	U002	72.00 x	122.00 x	— x	25.00 x	—
56953	U007	71.00 x	78.80 x	— x	10.00 x	—	—	CH	72.50 x	92.00 x	— x	42.00 x	—
56954	U008	71.00 x	78.80 x	— x	10.00 x	—	56996	U019	73.00 x	82.00 x	— x	5.50 x	—
56955	U004	71.00 x	80.00 x	— x	6.00 x	—	3353	C	73.00 x	82.50 x	— x	9.00 x	—
56956	U004	71.00 x	82.00 x	— x	5.50 x	—	51706	U	73.00 x	82.50 x	— x	9.53 x	—
56957	U019	71.00 x	82.00 x	— x	7.50 x	—	56997	U005	73.00 x	83.00 x	— x	8.00 x	—
56958	U005	71.00 x	82.00 x	— x	8.00 x	—	51273	U001	73.00 x	83.50 x	— x	7.50 x	—
56959	U002	71.00 x	82.00 x	— x	9.50 x	—	56998	U005	73.00 x	84.00 x	— x	13.50 x	—
51653	U	71.00 x	87.00 x	— x	10.00 x	—	56999	U006	73.00 x	84.00 x	— x	13.50 x	—
55758	U04A	71.00 x	88.00 x	— x	9.50 x	—	8268	V	73.00 x	88.00 x	— x	6.10 x	—
3199	C001	71.20 x	92.00 x	2.50 x	8.00 x	—	52927	U004	73.00 x	89.00 x	— x	8.00 x	—
50778	U004	71.44 x	80.96 x	— x	5.56 x	—	57000	U001	73.00 x	103.00 x	— x	20.00 x	—
56960	U004	71.50 x	79.00 x	— x	6.00 x	—	57001	U002	73.00 x	103.00 x	— x	20.00 x	—
56961	U004	71.50 x	80.00 x	— x	6.00 x	—	50916	U036	73.02 x	82.55 x	— x	5.56 x	—
56962	U019	71.50 x	82.00 x	— x	5.50 x	—	51569	U	73.02 x	85.72 x	— x	6.35 x	—
52475	U004	71.50 x	82.00 x	— x	6.00 x	—	55699	U	73.02 x	92.07 x	— x	9.52 x	—
56963	U003	71.50 x	82.50 x	— x	5.50 x	—	52500	U	73.03 x	82.50 x	— x	6.35 x	—
51673	U	71.50 x	82.50 x	— x	7.10 x	—	52500	U004	73.03 x	82.50 x	— x	6.35 x	—
—	CH	71.50 x	82.50 x	— x	31.00 x	—	59251	U04A	73.03 x	82.55 x	— x	9.53 x	—
53423	U	71.50 x	86.00 x	— x	12.00 x	—	51801	U002	73.03 x	83.34 x	— x	7.93 x	—
56964	U002	71.50 x	102.00 x	— x	15.00 x	—	—	U04A	73.03 x	85.73 x	— x	9.52 x	—
56965	U008	71.67 x	82.55 x	— x	7.94 x	—	57002	U002	73.03 x	88.90 x	— x	7.14 x	—





Cód	Mod	Di x	De x	Esp. x	Ha1 x	Ha2	Cód	Mod	Di x	De x	Esp. x	Ha1 x	Ha2
57003	U001	73.03 x	88.90 x	— x	7.94 x	—	57034	U001	75.00 x	90.00 x	— x	8.00 x	—
57004	U019	73.03 x	88.90 x	— x	7.94 x	—	8282	V	75.00 x	90.00 x	— x	8.00 x	—
—	U04A	73.03 x	88.90 x	— x	12.70 x	—	57035	U002	75.00 x	90.00 x	— x	12.00 x	—
8271	V	73.50 x	80.50 x	— x	4.00 x	—	57036	U004	75.00 x	90.00 x	— x	12.00 x	—
52032	U031	73.50 x	81.50 x	— x	5.50 x	—	57037	U005	75.00 x	90.00 x	— x	14.00 x	—
57005	U	73.50 x	87.70 x	— x	7.00 x	9.50	57039	U006	75.00 x	90.00 x	— x	14.00 x	—
50299	U007	73.50 x	87.70 x	— x	9.50 x	7.00	57040	U007	75.00 x	90.00 x	— x	14.00 x	—
57006	U001	74.00 x	80.00 x	— x	8.00 x	—	51629	U003	75.00 x	90.00 x	— x	16.00 x	—
57007	U002	74.00 x	80.00 x	— x	8.00 x	—	6284	CH	75.00 x	90.00 x	— x	23.00 x	—
57008	U007	74.00 x	80.00 x	— x	8.00 x	—	—	CH	75.00 x	90.50 x	— x	28.00 x	—
57009	U008	74.00 x	80.00 x	— x	8.00 x	—	53394	U	75.00 x	91.00 x	— x	9.50 x	—
50853	U019	74.00 x	82.00 x	— x	5.50 x	—	57041	U006	75.00 x	91.00 x	— x	10.00 x	—
59350	UL	74.00 x	84.00 x	— x	6.00 x	7.50	50998	U	75.00 x	92.00 x	— x	20.00 x	—
57010	U002	74.00 x	85.00 x	— x	12.00 x	—	57042	U002	75.00 x	95.00 x	— x	10.00 x	—
52691	U001	74.00 x	87.00 x	— x	9.00 x	—	51081	U003	75.00 x	95.00 x	— x	10.00 x	—
57011	U003	74.00 x	87.00 x	— x	9.00 x	—	57043	U019	75.00 x	95.00 x	— x	10.00 x	—
50317	U031	74.00 x	88.00 x	— x	8.50 x	—	8364	V	75.00 x	95.00 x	— x	10.00 x	—
57012	U004	74.00 x	88.50 x	— x	12.00 x	—	51175	U033	75.00 x	95.00 x	— x	11.00 x	—
57013	U004	74.00 x	89.00 x	— x	12.00 x	—	52564	U004	75.00 x	95.00 x	— x	12.00 x	—
6209	CH	74.00 x	89.00 x	— x	22.00 x	—	52564	U004	75.00 x	95.00 x	— x	12.00 x	—
8329	V	74.00 x	90.00 x	— x	5.00 x	—	52564	U004	75.00 x	95.00 x	— x	12.00 x	—
57014	U002	74.00 x	90.00 x	— x	7.50 x	—	53228	U004	75.00 x	95.00 x	— x	13.00 x	—
57015	U001	74.00 x	90.00 x	— x	8.00 x	—	57044	U001	75.00 x	95.00 x	— x	18.00 x	—
—	CH	74.00 x	90.00 x	— x	34.50 x	—	57045	U002	75.00 x	95.00 x	— x	18.00 x	—
57016	U001	74.00 x	92.00 x	— x	9.00 x	—	6378	CH	75.00 x	95.00 x	— x	57.00 x	—
55557	U04A	74.00 x	93.00 x	— x	11.00 x	—	6378	CH	75.00 x	95.00 x	— x	57.00 x	—
55557	U04A	74.00 x	93.00 x	— x	11.00 x	—	50315	U002	75.00 x	97.00 x	— x	11.00 x	—
57017	U001	74.00 x	95.00 x	— x	10.00 x	—	57046	U001	75.00 x	99.00 x	— x	12.00 x	—
57018	U002	74.00 x	95.00 x	— x	10.00 x	—	57047	U002	75.00 x	99.00 x	— x	12.00 x	—
51702	U	74.00 x	95.00 x	— x	12.20 x	—	57048	U001	75.00 x	99.00 x	— x	18.00 x	—
52904	U002	74.00 x	96.00 x	— x	6.00 x	—	57049	U002	75.00 x	99.00 x	— x	18.00 x	—
3360	C	74.00 x	100.00 x	4.00 x	12.50 x	—	57050	U001	75.00 x	100.00 x	— x	12.00 x	—
57019	U003	74.00 x	105.00 x	— x	15.00 x	—	57051	U002	75.00 x	100.00 x	— x	12.00 x	—
—	CH	74.00 x	105.00 x	— x	56.00 x	—	3359	C	75.00 x	100.00 x	3.00 x	12.50 x	—
52641	U	74.50 x	86.00 x	— x	9.50 x	—	53160	U002	75.00 x	100.00 x	— x	15.00 x	—
52641	U	74.50 x	86.00 x	— x	9.50 x	—	57052	U002	75.00 x	100.00 x	— x	15.00 x	—
50390	U002	74.50 x	88.50 x	— x	11.50 x	—	57053	U004	75.00 x	100.00 x	— x	15.00 x	—
—	CH	74.50 x	89.00 x	— x	38.00 x	—	57054	U019	75.00 x	100.00 x	— x	15.00 x	—
57020	U002	74.50 x	105.00 x	— x	17.00 x	—	57055	U001	75.00 x	100.00 x	— x	22.00 x	—
51328	U031	74.50 x	120.00 x	— x	27.00 x	—	57056	U002	75.00 x	100.00 x	— x	22.00 x	—
53234	U005	75.00 x	82.00 x	— x	8.00 x	—	6412	CH	75.00 x	100.00 x	— x	22.00 x	—
51108	U005	75.00 x	83.00 x	— x	11.50 x	—	57057	U001	75.00 x	105.00 x	— x	15.00 x	—
57021	U005	75.00 x	83.00 x	— x	12.00 x	—	57058	U002	75.00 x	105.00 x	— x	15.00 x	—
57022	U006	75.00 x	83.00 x	— x	12.00 x	—	57059	U019	75.00 x	105.00 x	— x	15.00 x	—
53219	UL	75.00 x	85.00 x	— x	6.00 x	—	—	CH	75.00 x	105.00 x	— x	46.00 x	—
53333	U002	75.00 x	85.00 x	— x	7.50 x	—	53085	U053	75.00 x	108.00 x	— x	13.00 x	—
53219	UL	75.00 x	85.00 x	— x	8.00 x	—	53325	U	75.00 x	109.00 x	— x	16.00 x	—
57023	U001	75.00 x	85.00 x	— x	12.00 x	—	57060	U001	75.00 x	115.00 x	— x	20.00 x	—
50641	U004	75.00 x	85.00 x	— x	12.00 x	—	57061	U002	75.00 x	115.00 x	— x	20.00 x	—
50080	U024	75.00 x	85.00 x	— x	12.00 x	—	57062	U001	75.00 x	120.00 x	— x	12.00 x	—
—	U04A	75.00 x	85.00 x	— x	12.00 x	—	57063	U002	75.00 x	120.00 x	— x	12.00 x	—
57024	U005	75.00 x	85.00 x	— x	13.50 x	—	57064	U003	75.00 x	120.00 x	— x	24.00 x	—
57025	U006	75.00 x	85.00 x	— x	13.50 x	—	57065	U001	75.00 x	120.50 x	— x	20.00 x	—
57026	U007	75.00 x	85.00 x	— x	13.50 x	—	57066	U002	75.00 x	120.50 x	— x	20.00 x	—
57027	U008	75.00 x	85.00 x	— x	13.50 x	—	3485	C	75.00 x	155.00 x	5.00 x	25.00 x	—
—	CH	75.00 x	85.00 x	— x	25.50 x	—	3485	C	75.00 x	155.00 x	— x	25.50 x	—
57028	U031	75.00 x	85.50 x	— x	5.00 x	—	52621	U031	75.50 x	90.00 x	— x	14.70 x	—
53404	U	75.00 x	87.00 x	— x	9.00 x	—	57067	U002	75.50 x	95.50 x	— x	15.00 x	—
57029	U031	75.00 x	88.00 x	— x	6.00 x	—	—	CH	75.50 x	96.50 x	— x	34.00 x	—
57030	U001	75.00 x	88.00 x	— x	6.50 x	—	52616	U	75.50 x	100.50 x	— x	16.00 x	—
51841	U021	75.00 x	88.00 x	— x	7.00 x	—	57068	U003	75.50 x	105.00 x	— x	15.00 x	—
51254	U	75.00 x	89.00 x	— x	5.50 x	—	3487	C	75.60 x	114.00 x	— x	20.00 x	—
53232	U	75.00 x	89.00 x	— x	8.50 x	—	3337	C	76.00 x	87.00 x	— x	5.50 x	—
57031	U006	75.00 x	89.00 x	— x	10.00 x	—	52473	U04A	76.00 x	88.00 x	— x	9.50 x	—
57032	U001	75.00 x	89.00 x	— x	10.50 x	—	53141	U	76.00 x	89.00 x	— x	8.00 x	—
51030	U	75.00 x	90.00 x	— x	7.50 x	—	53132	U002	76.00 x	89.00 x	— x	8.00 x	—
57033	U002	75.00 x	90.00 x	— x	7.50 x	—	52359	U	76.00 x	89.00 x	— x	10.00 x	—



Cód	Mod	Di x	De x	Esp. x	Ha1 x	Ha2	Cód	Mod	Di x	De x	Esp. x	Ha1 x	Ha2
52359	U	76.00 x	89.00 x	— x	10.00 x	—	50608	U003	76.20 x	107.95 x	— x	15.87 x	—
—	CH	76.00 x	89.00 x	— x	30.50 x	—	3088	C	76.20 x	114.30 x	7.00 x	14.00 x	—
57069	U005	76.00 x	90.00 x	— x	9.50 x	—	3172	C	76.20 x	152.40 x	3.50 x	17.46 x	—
57070	U005	76.00 x	90.00 x	— x	9.50 x	—	3318	C	76.20 x	152.40 x	— x	19.05 x	—
57071	U001	76.00 x	96.00 x	— x	10.00 x	—	51730	U065	76.50 x	85.00 x	— x	5.00 x	—
57072	U002	76.00 x	96.00 x	— x	10.00 x	—	51539	U04A	76.50 x	86.50 x	— x	5.00 x	—
57073	U001	76.00 x	97.00 x	— x	10.00 x	—	55741	U004	76.50 x	97.00 x	— x	12.00 x	—
57074	U002	76.00 x	97.00 x	— x	10.00 x	—	57093	U003	76.50 x	99.00 x	— x	13.00 x	—
50149	U030	76.00 x	102.00 x	— x	16.00 x	—	52769	U019	76.50 x	99.00 x	— x	13.00 x	—
50149	U030	76.00 x	102.00 x	— x	16.00 x	—	3321	C	76.50 x	178.00 x	— x	19.00 x	—
50149	U030	76.00 x	102.00 x	— x	16.00 x	—	50367	U044	77.00 x	85.00 x	— x	13.50 x	—
57075	U001	76.00 x	105.00 x	— x	15.00 x	—	53266	U002	77.00 x	89.00 x	— x	9.50 x	—
57076	U002	76.00 x	105.00 x	— x	15.00 x	—	52545	U	77.00 x	90.00 x	— x	7.00 x	—
53490	U	76.00 x	107.00 x	— x	16.00 x	—	52545	U001	77.00 x	90.00 x	— x	7.00 x	—
3019	C	76.00 x	130.00 x	5.00 x	15.00 x	—	57094	U003	77.00 x	90.00 x	— x	7.00 x	—
3326	C	76.00 x	153.00 x	5.50 x	19.00 x	—	—	CH	77.00 x	91.00 x	— x	24.50 x	—
51708	U	76.20 x	84.13 x	— x	6.35 x	—	57095	U007	77.00 x	92.00 x	— x	10.00 x	—
51708	U	76.20 x	84.13 x	— x	6.35 x	—	57096	U008	77.00 x	92.00 x	— x	10.00 x	—
51818	U	76.20 x	85.73 x	— x	4.76 x	—	51143	U04A	77.00 x	93.00 x	— x	13.00 x	—
51818	U002	76.20 x	85.73 x	— x	4.76 x	—	52083	U002	77.00 x	94.00 x	— x	9.50 x	9.00
57077	U019	76.20 x	85.73 x	— x	7.54 x	—	51764	U	77.00 x	94.00 x	— x	12.00 x	—
57078	U004	76.20 x	86.00 x	— x	12.00 x	—	—	CH	77.00 x	97.00 x	— x	46.00 x	—
50918	U031	76.20 x	86.60 x	— x	6.00 x	—	53422	U04A	77.00 x	103.00 x	— x	22.00 x	—
50918	U031	76.20 x	86.60 x	— x	6.00 x	—	3158	C	77.00 x	104.00 x	— x	14.00 x	—
57079	U002	76.20 x	86.69 x	— x	9.53 x	—	51538	U	77.40 x	86.50 x	— x	5.70 x	—
59386	UL	76.20 x	88.00 x	— x	8.60 x	9.00	51756	U	77.50 x	89.40 x	— x	8.40 x	—
50804	U002	76.20 x	88.90 x	— x	5.50 x	—	52797	U	77.50 x	100.00 x	— x	15.00 x	—
51667	U026	76.20 x	88.90 x	— x	6.00 x	—	57097	U004	77.79 x	87.31 x	— x	5.56 x	—
—	U04A	76.20 x	88.90 x	— x	6.35 x	—	57098	U031	77.79 x	88.90 x	— x	5.56 x	—
59412	UL	76.20 x	88.90 x	— x	7.00 x	10.00	57099	U019	77.79 x	101.60 x	— x	12.70 x	—
59412	UL	76.20 x	88.90 x	— x	7.00 x	10.00	57103	U001	78.00 x	86.00 x	— x	8.00 x	—
59393	UL	76.20 x	88.90 x	— x	7.50 x	8.60	57100	U002	78.00 x	86.00 x	— x	8.00 x	—
57080	U004	76.20 x	88.90 x	— x	9.92 x	—	57101	U007	78.00 x	86.00 x	— x	8.00 x	—
50910	U	76.20 x	88.90 x	— x	10.00 x	—	57102	U008	78.00 x	86.00 x	— x	8.00 x	—
52446	UL	76.20 x	88.90 x	— x	10.00 x	—	57104	U005	78.00 x	86.00 x	— x	12.00 x	—
50558	U031	76.20 x	88.90 x	— x	10.32 x	—	57105	U006	78.00 x	86.00 x	— x	12.00 x	—
50558	U031	76.20 x	88.90 x	— x	10.32 x	—	57106	U019	78.00 x	86.00 x	— x	13.00 x	—
50415	U004	76.20 x	88.90 x	— x	11.91 x	—	57107	U005	78.00 x	86.00 x	— x	13.50 x	—
—	CH	76.20 x	88.90 x	— x	30.00 x	—	57108	U006	78.00 x	86.00 x	— x	13.50 x	—
—	CH	76.20 x	88.90 x	— x	39.00 x	—	50581	U024	78.00 x	86.00 x	— x	14.50 x	—
6041	CH	76.20 x	88.90 x	— x	50.80 x	—	50768	U004	78.00 x	88.00 x	— x	5.50 x	—
51659	U041	76.20 x	89.00 x	— x	9.30 x	8.00	57109	U002	78.00 x	88.00 x	— x	6.00 x	—
51918	U001	76.20 x	89.96 x	— x	9.52 x	—	50622	U024	78.00 x	89.00 x	— x	15.00 x	—
57081	U005	76.20 x	90.00 x	— x	15.00 x	—	53321	U002	78.00 x	90.00 x	— x	5.50 x	—
57082	U006	76.20 x	90.00 x	— x	15.00 x	—	53433	U008	78.00 x	90.00 x	— x	8.60 x	—
57083	U019	76.20 x	92.08 x	— x	7.94 x	—	57110	U008	78.00 x	90.00 x	— x	8.60 x	—
57084	U002	76.20 x	92.08 x	— x	11.11 x	—	52768	U004	78.00 x	90.00 x	— x	10.00 x	—
—	U04A	76.20 x	92.08 x	— x	12.70 x	—	57111	U004	78.00 x	90.00 x	— x	10.00 x	—
59461	U04A	76.20 x	92.08 x	— x	12.70 x	—	57112	U001	78.00 x	90.00 x	— x	12.00 x	—
57085	U002	76.20 x	94.46 x	— x	9.53 x	—	57113	U002	78.00 x	90.00 x	— x	12.00 x	—
52963	U	76.20 x	95.20 x	— x	9.53 x	—	57114	U002	78.00 x	95.00 x	— x	6.00 x	—
50560	U003	76.20 x	95.25 x	— x	9.52 x	—	57115	U001	78.00 x	98.00 x	— x	15.00 x	—
57086	U002	76.20 x	95.25 x	— x	9.53 x	—	57116	U002	78.00 x	98.00 x	— x	15.00 x	—
52963	U04A	76.20 x	95.25 x	— x	9.53 x	—	—	CH	78.00 x	98.00 x	— x	52.00 x	—
57087	U001	76.20 x	95.25 x	— x	10.00 x	—	57117	U001	78.00 x	100.00 x	— x	10.00 x	—
57089	U04A	76.20 x	95.25 x	— x	14.28 x	—	57118	U002	78.00 x	101.60 x	— x	— x	—
57088	U004	76.20 x	95.25 x	— x	15.08 x	—	51084	U	78.00 x	102.00 x	— x	12.00 x	—
59341	U04A	76.20 x	95.25 x	— x	15.87 x	—	57119	U002	78.00 x	102.00 x	— x	12.00 x	—
6158	CH	76.20 x	95.25 x	— x	21.00 x	—	57120	U001	78.00 x	110.00 x	— x	16.00 x	—
6088	CH	76.20 x	98.42 x	— x	22.22 x	—	57121	U002	78.00 x	110.00 x	— x	16.00 x	—
57090	U019	76.20 x	98.43 x	— x	9.53 x	—	50281	U003	78.00 x	110.00 x	— x	16.50 x	—
57091	U002	76.20 x	100.81 x	— x	11.91 x	—	50281	U003	78.00 x	110.00 x	— x	16.50 x	—
50974	U002	76.20 x	101.60 x	— x	6.30 x	—	57122	U001	78.00 x	115.00 x	— x	15.00 x	—
—	U04A	76.20 x	101.60 x	— x	12.70 x	—	57123	U002	78.00 x	115.00 x	— x	15.00 x	—
3149	C	76.20 x	101.60 x	— x	14.29 x	—	51361	U026	78.00 x	120.00 x	— x	27.00 x	—
—	CH	76.20 x	101.60 x	— x	39.50 x	—	57124	U001	78.50 x	110.00 x	— x	15.00 x	—
57092	U	76.20 x	107.95 x	— x	15.87 x	—	57125	U002	78.50 x	110.00 x	— x	15.00 x	—



Cód	Mod	Di x	De x	Esp. x	Ha1 x	Ha2	Cód	Mod	Di x	De x	Esp. x	Ha1 x	Ha2
57126	U031	78.58 x	95.25 x	— x	9.53 x	—	53031	U04A	80.00 x	93.00 x	— x	11.00 x	—
57127	U005	79.00 x	87.00 x	— x	12.00 x	—	53186	U04A	80.00 x	93.00 x	— x	11.00 x	—
57128	U004	79.00 x	90.00 x	— x	12.00 x	—	53523	U001	80.00 x	94.00 x	— x	9.00 x	—
52905	U002	79.00 x	91.00 x	— x	6.00 x	—	59397	UL	80.00 x	95.00 x	— x	4.00 x	7.00
52905	U	79.00 x	92.00 x	— x	6.00 x	—	57155	U002	80.00 x	95.00 x	— x	6.00 x	—
53247	U	79.00 x	92.00 x	— x	13.00 x	—	57156	U001	80.00 x	95.00 x	— x	7.50 x	—
52339	U027	79.00 x	101.50 x	— x	10.00 x	—	57157	U002	80.00 x	95.00 x	— x	7.50 x	—
53487	U	79.00 x	105.00 x	— x	12.00 x	—	53374	U002	80.00 x	95.00 x	— x	9.00 x	—
53486	U	79.00 x	106.00 x	— x	16.00 x	—	—	U04A	80.00 x	95.00 x	— x	9.00 x	—
57129	U003	79.00 x	110.00 x	— x	15.00 x	—	50103	U019	80.00 x	95.00 x	— x	11.00 x	—
53489	U	79.00 x	115.00 x	— x	16.00 x	—	50676	U	80.00 x	95.00 x	— x	12.00 x	—
57131	U002	79.00 x	115.00 x	— x	30.00 x	—	57158	U004	80.00 x	95.00 x	— x	12.00 x	—
50503	U080	79.37 x	87.31 x	— x	14.29 x	—	50057	U019	80.00 x	95.00 x	— x	12.00 x	—
50210	U024	79.37 x	95.25 x	— x	19.05 x	—	50085	U024	80.00 x	95.00 x	— x	19.00 x	—
6358	CH	79.37 x	111.12 x	— x	78.58 x	—	6259	CH	80.00 x	95.00 x	— x	22.50 x	—
57132	U04A	79.38 x	88.90 x	— x	9.53 x	—	6266	CH	80.00 x	95.00 x	— x	23.00 x	—
57133	U008	79.38 x	88.90 x	— x	13.49 x	—	6266	CH	80.00 x	95.00 x	— x	23.00 x	—
57134	U007	79.38 x	90.49 x	— x	14.29 x	—	6266	CH	80.00 x	95.00 x	— x	23.50 x	—
—	U04A	79.38 x	92.08 x	— x	9.52 x	—	51252	U002	80.00 x	96.00 x	— x	8.00 x	—
52365	U004	79.38 x	95.25 x	— x	7.90 x	—	50872	U	80.00 x	98.00 x	— x	9.00 x	—
57135	U019	79.38 x	98.43 x	— x	9.53 x	—	59246	U04A	80.00 x	98.00 x	— x	16.00 x	—
—	CH	79.38 x	103.19 x	— x	35.00 x	—	F4578	J	80.00 x	99.00 x	— x	13.00 x	18.00
57136	U004	79.50 x	100.00 x	— x	15.00 x	—	F4128	W	80.00 x	100.00 x	— x	6.00 x	7.00
52090	U002	79.60 x	100.00 x	— x	15.00 x	—	8080	V	80.00 x	100.00 x	— x	7.00 x	—
3446	C	80.00 x	13.00 x	— x	4.00 x	—	8162	V	80.00 x	100.00 x	— x	8.00 x	—
53296	U	80.00 x	88.00 x	— x	4.00 x	7.50	8162	V	80.00 x	100.00 x	— x	8.00 x	—
55579	UL	80.00 x	88.00 x	— x	6.00 x	7.50	F4113	W	80.00 x	100.00 x	— x	9.50 x	9.00
57137	U005	80.00 x	88.00 x	— x	12.00 x	—	55617	U	80.00 x	100.00 x	— x	9.80 x	—
57138	U006	80.00 x	88.00 x	— x	12.00 x	—	57159	U001	80.00 x	100.00 x	— x	10.00 x	—
51167	U	80.00 x	90.00 x	— x	6.00 x	—	57160	U002	80.00 x	100.00 x	— x	10.00 x	—
57139	U002	80.00 x	90.00 x	— x	6.00 x	—	57161	U003	80.00 x	100.00 x	— x	10.00 x	—
51167	U004	80.00 x	90.00 x	— x	6.00 x	—	57162	U019	80.00 x	100.00 x	— x	10.00 x	—
51167	U004	80.00 x	90.00 x	— x	6.00 x	—	50386	U020	80.00 x	100.00 x	— x	10.00 x	—
52266	U004	80.00 x	90.00 x	— x	8.00 x	—	51691	U04A	80.00 x	100.00 x	— x	10.00 x	—
53024	U004	80.00 x	90.00 x	— x	8.00 x	—	52031	U04A	80.00 x	100.00 x	— x	10.00 x	—
53024	U004	80.00 x	90.00 x	— x	8.00 x	—	52031	U04A	80.00 x	100.00 x	— x	10.00 x	—
55632	U004	80.00 x	90.00 x	— x	8.00 x	—	51691	U04A	80.00 x	100.00 x	— x	10.00 x	—
55705	U04A	80.00 x	90.00 x	— x	8.50 x	—	52031	U058	80.00 x	100.00 x	— x	10.00 x	—
51587	U004	80.00 x	90.00 x	— x	10.00 x	—	50572	U019	80.00 x	100.00 x	— x	10.30 x	—
57141	U007	80.00 x	90.00 x	— x	10.00 x	—	8133	V	80.00 x	100.00 x	— x	10.50 x	—
57142	U008	80.00 x	90.00 x	— x	10.00 x	—	8134	V	80.00 x	100.00 x	— x	11.00 x	—
51587	U031	80.00 x	90.00 x	— x	10.00 x	—	51497	U	80.00 x	100.00 x	— x	12.00 x	—
55610	U031	80.00 x	90.00 x	— x	10.00 x	—	57163	U	80.00 x	100.00 x	— x	12.00 x	13.00
52154	U004	80.00 x	90.00 x	— x	10.40 x	—	52800	U001	80.00 x	100.00 x	— x	12.00 x	—
52154	U004	80.00 x	90.00 x	— x	10.40 x	—	50965	U002	80.00 x	100.00 x	— x	12.00 x	—
52154	U004	80.00 x	90.00 x	— x	10.40 x	—	51489	U004	80.00 x	100.00 x	— x	12.00 x	—
57143	U002	80.00 x	90.00 x	— x	10.50 x	—	57164	U001	80.00 x	100.00 x	— x	12.50 x	—
57144	U005	80.00 x	90.00 x	— x	10.50 x	—	57165	U	80.00 x	100.00 x	— x	13.00 x	—
57145	U006	80.00 x	90.00 x	— x	10.50 x	—	57166	U004	80.00 x	100.00 x	— x	13.00 x	—
57146	U004	80.00 x	90.00 x	— x	12.00 x	—	57167	U006	80.00 x	100.00 x	— x	13.00 x	—
51616	U005	80.00 x	90.00 x	— x	13.50 x	12.00	50600	U008	80.00 x	100.00 x	— x	13.00 x	12.00
57147	U007	80.00 x	90.00 x	— x	13.50 x	—	50271	U032	80.00 x	100.00 x	— x	13.00 x	—
57148	U008	80.00 x	90.00 x	— x	13.50 x	—	50753	U005	80.00 x	100.00 x	— x	14.00 x	10.00
8232	V	80.00 x	90.00 x	— x	13.50 x	—	50738	U	80.00 x	100.00 x	— x	14.50 x	—
50952	U	80.00 x	90.00 x	— x	14.00 x	12.00	50903	U001	80.00 x	100.00 x	— x	15.00 x	—
57149	U005	80.00 x	90.00 x	— x	14.00 x	—	50903	U001	80.00 x	100.00 x	— x	15.00 x	—
57150	U006	80.00 x	90.00 x	— x	14.00 x	—	50054	U002	80.00 x	100.00 x	— x	15.00 x	—
57151	U006	80.00 x	92.00 x	— x	8.50 x	—	50902	U004	80.00 x	100.00 x	— x	15.00 x	—
57152	U005	80.00 x	92.00 x	— x	9.00 x	—	51762	U004	80.00 x	100.00 x	— x	15.00 x	—
57153	U002	80.00 x	93.00 x	— x	8.00 x	—	50902	U004	80.00 x	100.00 x	— x	15.00 x	—
51114	U031	80.00 x	93.00 x	— x	8.00 x	—	8233	V	80.00 x	100.00 x	— x	15.00 x	—
51114	U031	80.00 x	93.00 x	— x	8.00 x	—	52082	U	80.00 x	100.00 x	— x	15.80 x	—
57154	U003	80.00 x	93.00 x	— x	8.50 x	—	52082	U004	80.00 x	100.00 x	— x	15.80 x	—
53186	U	80.00 x	93.00 x	— x	11.00 x	—	57168	U001	80.00 x	100.00 x	— x	18.00 x	—
53031	U04A	80.00 x	93.00 x	— x	11.00 x	—	57169	U002	80.00 x	100.00 x	— x	18.00 x	—
53186	U04A	80.00 x	93.00 x	— x	11.00 x	—	6120	CH	80.00 x	100.00 x	— x	18.00 x	—
53031	U04A	80.00 x	93.00 x	— x	11.00 x	—	57170	U005	80.00 x	100.00 x	— x	20.50 x	—



Cód	Mod	Di x	De x	Esp. x	Ha1 x	Ha2	Cód	Mod	Di x	De x	Esp. x	Ha1 x	Ha2
6102	CH	80.00 x	100.00 x	— x	35.00 x	—	57206	U005	81.00 x	92.50 x	— x	8.00 x	—
6103	CH	80.00 x	100.00 x	— x	45.00 x	—	59369	UL	81.00 x	95.00 x	— x	7.00 x	10.50
6103	CH	80.00 x	100.00 x	— x	45.00 x	—	F255	J	81.00 x	99.00 x	— x	11.00 x	18.80
57171	U001	80.00 x	101.00 x	— x	10.00 x	—	50502	U031	81.00 x	100.00 x	— x	10.20 x	—
57172	U002	80.00 x	101.00 x	— x	10.00 x	—	57207	U002	81.00 x	100.00 x	— x	12.00 x	—
52646	U	80.00 x	101.00 x	— x	12.00 x	—	50602	U004	81.00 x	100.00 x	— x	12.00 x	—
57173	U001	80.00 x	102.00 x	— x	16.00 x	—	57208	U008	81.00 x	100.00 x	— x	12.00 x	—
57174	U002	80.00 x	102.00 x	— x	16.00 x	—	50441	U002	81.00 x	101.00 x	— x	13.00 x	—
6392	CH	80.00 x	102.00 x	— x	17.00 x	—	57209	U001	81.00 x	115.00 x	— x	15.00 x	—
53443	U04A	80.00 x	103.00 x	— x	16.00 x	—	57210	U002	81.00 x	115.00 x	— x	15.00 x	—
57175	U001	80.00 x	104.00 x	— x	12.00 x	—	52226	U	81.00 x	120.60 x	— x	27.00 x	—
57176	U002	80.00 x	104.00 x	— x	12.00 x	—	50650	U065	81.50 x	95.50 x	— x	7.50 x	—
57177	U001	80.00 x	105.00 x	— x	12.00 x	—	57211	U004	81.50 x	100.50 x	— x	14.50 x	—
57178	U002	80.00 x	105.00 x	— x	12.00 x	—	57212	U002	81.50 x	101.50 x	— x	11.00 x	—
57179	U019	80.00 x	105.00 x	— x	12.00 x	—	51466	U	82.00 x	92.00 x	— x	2.50 x	—
3143	C	80.00 x	105.00 x	— x	14.00 x	—	57213	U001	82.00 x	92.00 x	— x	10.00 x	—
50879	U	80.00 x	105.00 x	— x	15.00 x	—	57214	U002	82.00 x	92.00 x	— x	10.00 x	—
52456	U046	80.00 x	105.00 x	— x	15.00 x	—	57215	U004	82.00 x	92.00 x	— x	10.00 x	—
57180	U001	80.00 x	105.00 x	— x	15.50 x	—	57216	U006	82.00 x	94.00 x	— x	8.50 x	—
57181	U002	80.00 x	105.00 x	— x	15.50 x	—	52240	U	82.00 x	94.00 x	— x	10.00 x	—
57182	U001	80.00 x	105.00 x	— x	22.00 x	—	52240	U006	82.00 x	94.00 x	— x	10.00 x	—
57183	U002	80.00 x	105.00 x	— x	22.00 x	—	8317	V	82.00 x	94.00 x	— x	15.00 x	—
6241	CH	80.00 x	105.00 x	— x	51.50 x	—	F14689	W	82.00 x	100.00 x	— x	7.50 x	9.50
57184	U001	80.00 x	108.00 x	— x	15.00 x	—	57217	U002	82.00 x	100.00 x	— x	9.00 x	—
57185	U002	80.00 x	108.00 x	— x	15.00 x	—	52960	U056	82.00 x	100.00 x	— x	9.00 x	—
57186	U002	80.00 x	110.00 x	— x	12.00 x	—	57218	U002	82.00 x	100.00 x	— x	11.00 x	—
57187	U001	80.00 x	110.00 x	— x	15.00 x	—	—	CH	82.00 x	100.00 x	— x	36.00 x	—
57188	U002	80.00 x	110.00 x	— x	15.00 x	—	51072	U	82.00 x	101.00 x	— x	9.50 x	—
57189	U019	80.00 x	110.00 x	— x	15.00 x	—	57219	U002	82.00 x	101.50 x	— x	12.00 x	—
52405	U	80.00 x	110.00 x	— x	16.00 x	—	51304	U	82.00 x	101.60 x	— x	12.50 x	11.00
50530	U003	80.00 x	110.00 x	— x	16.00 x	—	57220	U007	82.00 x	101.60 x	— x	12.50 x	—
57190	U002	80.00 x	110.00 x	— x	22.00 x	—	—	CH	82.00 x	102.00 x	— x	46.00 x	—
6294	CH	80.00 x	110.00 x	— x	62.50 x	—	53459	U	82.00 x	107.90 x	— x	12.70 x	—
6438	CH	80.00 x	110.00 x	— x	80.00 x	—	53459	U	82.00 x	107.90 x	— x	12.70 x	—
57191	U007	80.00 x	115.00 x	— x	14.00 x	—	50168	U003	82.00 x	108.00 x	— x	16.00 x	—
57192	U001	80.00 x	115.00 x	— x	15.00 x	—	—	CH	82.00 x	108.00 x	— x	48.00 x	—
57193	U002	80.00 x	115.00 x	— x	15.00 x	—	53327	U	82.00 x	109.00 x	— x	12.70 x	—
57194	U002	80.00 x	115.00 x	— x	30.00 x	—	57221	U001	82.00 x	112.00 x	— x	15.00 x	—
57195	U002	80.00 x	116.50 x	— x	24.00 x	—	57222	U002	82.00 x	112.00 x	— x	15.00 x	—
57196	U001	80.00 x	120.00 x	— x	20.00 x	—	57223	U004	82.00 x	112.50 x	— x	11.00 x	—
57197	U002	80.00 x	120.00 x	— x	20.00 x	—	57224	U001	82.00 x	115.00 x	— x	15.00 x	—
57198	U001	80.00 x	125.00 x	— x	20.00 x	—	57225	U002	82.00 x	115.00 x	— x	15.00 x	—
57199	U002	80.00 x	125.00 x	— x	20.00 x	—	53326	U	82.00 x	118.00 x	— x	13.50 x	18.00
3113	C	80.00 x	130.00 x	3.50 x	12.00 x	—	57226	U001	82.00 x	120.00 x	— x	15.00 x	—
3209	C001	80.00 x	130.00 x	7.00 x	15.00 x	—	57227	U002	82.00 x	120.00 x	— x	15.00 x	—
—	C	80.00 x	165.00 x	— x	21.00 x	—	3488	C	82.00 x	140.00 x	— x	4.00 x	—
3373	C	80.00 x	170.00 x	4.00 x	19.50 x	—	3488	C	82.00 x	140.00 x	— x	10.00 x	—
57200	U002	80.17 x	101.60 x	— x	14.29 x	—	3308	C	82.00 x	151.00 x	— x	26.00 x	—
52514	U	80.30 x	95.60 x	— x	10.00 x	—	3258	C	82.00 x	152.00 x	3.00 x	15.00 x	—
—	CH	80.50 x	104.50 x	— x	42.00 x	—	57228	U004	82.20 x	101.00 x	— x	13.00 x	—
3427	C	80.50 x	105.00 x	3.00 x	12.00 x	—	52717	U	82.50 x	100.01 x	— x	8.73 x	—
3427	C	80.50 x	105.00 x	— x	12.00 x	—	52349	U002	82.50 x	101.60 x	— x	9.92 x	—
52798	U	80.50 x	122.50 x	— x	13.30 x	—	52676	U04A	82.50 x	101.60 x	— x	15.80 x	—
52798	U002	80.50 x	122.50 x	— x	13.30 x	—	52676	U04A	82.50 x	101.60 x	— x	15.80 x	—
50467	U004	80.96 x	88.90 x	— x	6.35 x	—	52676	U04A	82.50 x	101.60 x	— x	15.80 x	—
52454	U	80.96 x	95.25 x	— x	9.52 x	—	3484	C	82.50 x	127.00 x	— x	12.70 x	—
—	CH	80.96 x	95.25 x	— x	31.50 x	—	3484	C	82.50 x	127.00 x	4.70 x	12.70 x	—
—	CH	80.96 x	98.43 x	— x	38.00 x	—	—	U04A	82.55 x	95.25 x	— x	6.35 x	—
57201	U002	80.96 x	99.22 x	— x	9.53 x	—	—	U04A	82.55 x	95.25 x	— x	9.52 x	—
—	U04A	80.96 x	100.00 x	— x	9.52 x	—	57229	U007	82.55 x	95.25 x	— x	9.53 x	—
57202	U002	80.96 x	101.60 x	— x	11.11 x	—	51641	U04A	82.55 x	95.25 x	— x	12.70 x	—
50106	U032	80.96 x	101.60 x	— x	12.70 x	—	57230	U019	82.55 x	100.81 x	— x	14.29 x	—
—	CH	80.96 x	106.36 x	— x	53.00 x	—	F15385	W	82.55 x	101.30 x	— x	8.00 x	10.00
57203	U004	81.00 x	89.50 x	— x	6.00 x	—	57231	U002	82.55 x	101.60 x	— x	7.94 x	—
57204	U005	81.00 x	90.00 x	— x	15.00 x	—	51537	U002	82.55 x	101.60 x	— x	7.94 x	—
57205	U006	81.00 x	90.00 x	— x	15.00 x	—	51537	U002	82.55 x	101.60 x	— x	7.94 x	—
50438	U024	81.00 x	90.00 x	— x	18.00 x	—	8397	V	82.55 x	101.60 x	— x	8.80 x	—





Cód	Mod	Di x	De x	Esp. x	Ha1 x	Ha2	Cód	Mod	Di x	De x	Esp. x	Ha1 x	Ha2
F1437	W	82.55 x	101.60 x	— x	9.20 x	8.50	53355	U	84.00 x	100.00 x	— x	10.00 x	—
50689	U	82.55 x	101.60 x	— x	9.52 x	—	57254	U019	84.00 x	100.00 x	— x	13.00 x	—
50201	U002	82.55 x	101.60 x	— x	9.52 x	—	51856	U061	84.00 x	100.00 x	— x	13.00 x	—
50715	U013	82.55 x	101.60 x	— x	9.52 x	—	57255	U007	84.00 x	100.50 x	— x	8.00 x	—
52612	U	82.55 x	101.60 x	— x	9.53 x	—	F8017	W	84.00 x	101.00 x	— x	9.00 x	8.00
51507	U	82.55 x	101.60 x	— x	9.53 x	—	57256	U001	84.00 x	110.00 x	— x	13.00 x	—
57232	U001	82.55 x	101.60 x	— x	9.53 x	—	57257	U002	84.00 x	110.00 x	— x	13.00 x	—
52612	U004	82.55 x	101.60 x	— x	9.53 x	—	57258	U019	84.00 x	111.00 x	— x	12.00 x	—
52216	U029	82.55 x	101.60 x	— x	9.53 x	—	57259	U001	84.00 x	115.00 x	— x	15.00 x	—
52216	U029	82.55 x	101.60 x	— x	9.53 x	—	57260	U002	84.00 x	115.00 x	— x	15.00 x	—
57233	U031	82.55 x	101.60 x	— x	9.92 x	—	51415	U001	84.00 x	120.00 x	— x	15.00 x	—
53373	U	82.55 x	101.60 x	— x	10.00 x	—	57261	U001	84.00 x	120.00 x	— x	15.00 x	—
53373	U04A	82.55 x	101.60 x	— x	10.00 x	—	8053	V	84.14 x	100.01 x	— x	7.14 x	—
8083	V	82.55 x	101.60 x	— x	10.32 x	—	57262	U019	84.14 x	104.78 x	— x	11.11 x	—
53385	U002	82.55 x	101.60 x	— x	13.00 x	—	57263	U004	84.50 x	95.00 x	— x	12.00 x	—
57234	U001	82.55 x	101.60 x	— x	18.00 x	—	57264	U004	84.50 x	98.00 x	— x	9.00 x	—
57235	U002	82.55 x	101.60 x	— x	18.00 x	—	53168	U001	84.50 x	98.50 x	— x	8.10 x	—
6023	CH	82.55 x	101.60 x	— x	30.16 x	—	52444	U046	84.50 x	104.50 x	— x	14.50 x	—
6023	CH	82.55 x	101.60 x	— x	30.16 x	—	57265	U007	84.53 x	101.20 x	— x	9.92 x	—
—	CH	82.55 x	101.60 x	— x	45.00 x	—	57266	U008	84.53 x	101.20 x	— x	9.92 x	—
—	CH	82.55 x	102.39 x	— x	36.50 x	—	53069	U004	85.00 x	92.00 x	— x	11.00 x	—
53488	U	82.55 x	107.95 x	— x	12.70 x	—	51062	U	85.00 x	93.00 x	— x	13.50 x	12.00
—	CH	82.55 x	107.95 x	— x	49.00 x	—	57267	U001	85.00 x	94.00 x	— x	14.00 x	—
6202	CH	82.55 x	108.00 x	— x	47.63 x	—	57268	U002	85.00 x	94.00 x	— x	14.00 x	—
51551	U	82.55 x	111.10 x	— x	15.87 x	—	57269	U005	85.00 x	94.00 x	— x	14.00 x	—
3298	C	82.55 x	127.00 x	— x	23.80 x	—	57270	U006	85.00 x	94.00 x	— x	14.00 x	—
3231	C	82.60 x	101.60 x	3.00 x	9.00 x	—	57271	U001	85.00 x	95.00 x	— x	5.00 x	—
52408	U061	82.70 x	96.00 x	— x	6.50 x	—	57272	U002	85.00 x	95.00 x	— x	5.00 x	—
52190	U	82.70 x	100.50 x	— x	9.50 x	—	57273	U007	85.00 x	95.00 x	— x	9.50 x	—
52190	U	82.70 x	100.50 x	— x	9.50 x	—	55552	U	85.00 x	95.00 x	— x	12.00 x	—
55720	U001	83.00 x	100.00 x	— x	13.30 x	—	57274	U007	85.00 x	95.00 x	— x	13.50 x	—
—	CH	83.00 x	100.00 x	— x	31.00 x	—	57275	U008	85.00 x	95.00 x	— x	13.50 x	—
50599	U049	83.00 x	101.00 x	— x	9.80 x	—	50865	U008	85.00 x	96.00 x	— x	9.50 x	6.30
57236	U019	83.00 x	101.00 x	— x	10.50 x	—	53068	U	85.00 x	98.00 x	— x	11.00 x	—
51275	U008	83.00 x	101.00 x	— x	17.00 x	15.00	57276	U007	85.00 x	98.50 x	— x	16.00 x	—
57237	U002	83.00 x	101.50 x	— x	13.00 x	—	51796	U04A	85.00 x	99.50 x	— x	9.20 x	—
50320	U031	83.00 x	101.50 x	— x	14.00 x	—	51317	U	85.00 x	100.00 x	— x	6.35 x	—
50604	U065	83.00 x	101.60 x	— x	12.00 x	—	8117	V	85.00 x	100.00 x	— x	7.00 x	—
57238	U019	83.00 x	102.00 x	— x	13.50 x	—	57277	U001	85.00 x	100.00 x	— x	7.50 x	—
57239	U031	83.00 x	102.50 x	— x	9.50 x	—	57278	U002	85.00 x	100.00 x	— x	7.50 x	—
57240	U001	83.00 x	110.00 x	— x	13.00 x	—	55585	U	85.00 x	100.00 x	— x	8.00 x	—
57241	U002	83.00 x	110.00 x	— x	13.00 x	—	53108	U001	85.00 x	100.00 x	— x	8.00 x	—
57242	U001	83.00 x	112.00 x	— x	15.00 x	—	57279	U002	85.00 x	100.00 x	— x	8.00 x	—
57243	U002	83.00 x	112.00 x	— x	15.00 x	—	52632	U001	85.00 x	100.00 x	— x	9.00 x	—
57244	U001	83.00 x	114.00 x	— x	15.00 x	—	3410	C	85.00 x	100.00 x	— x	12.00 x	—
57245	U002	83.00 x	114.00 x	— x	15.00 x	—	50182	U004	85.00 x	100.00 x	— x	12.00 x	—
57246	U001	83.00 x	115.00 x	— x	15.00 x	—	50182	U004	85.00 x	100.00 x	— x	12.00 x	—
57247	U002	83.00 x	115.00 x	— x	15.00 x	—	57280	U008	85.00 x	100.00 x	— x	12.00 x	—
57248	U007	83.34 x	99.22 x	— x	8.33 x	—	50208	U031	85.00 x	100.00 x	— x	12.00 x	—
50629	U002	83.40 x	101.20 x	— x	9.50 x	—	52274	U019	85.00 x	100.00 x	— x	13.50 x	—
50629	U002	83.40 x	101.20 x	— x	9.50 x	—	50179	U004	85.00 x	100.00 x	— x	15.00 x	—
53293	U002	83.40 x	101.80 x	— x	12.70 x	—	50179	U004	85.00 x	100.00 x	— x	15.00 x	—
53046	U	83.50 x	94.20 x	— x	5.30 x	—	50179	U004	85.00 x	100.00 x	— x	15.00 x	—
53046	U019	83.50 x	94.20 x	— x	5.30 x	—	6022	CH	85.00 x	100.00 x	— x	25.00 x	—
50294	U061	83.50 x	99.50 x	— x	13.50 x	—	57281	U002	85.00 x	102.00 x	— x	13.00 x	—
50114	U	83.50 x	101.00 x	— x	10.00 x	—	57282	U007	85.00 x	102.00 x	— x	16.00 x	—
50114	U	83.50 x	101.00 x	— x	10.00 x	—	57283	U008	85.00 x	102.00 x	— x	16.00 x	—
57249	U002	83.50 x	101.50 x	— x	14.00 x	—	57284	U002	85.00 x	104.00 x	— x	14.00 x	—
53403	U	84.00 x	96.00 x	— x	9.00 x	—	8355	V	85.00 x	105.00 x	— x	9.50 x	—
57248	U005	84.00 x	96.00 x	— x	13.00 x	—	50701	U001	85.00 x	105.00 x	— x	10.00 x	—
57249	U006	84.00 x	96.00 x	— x	13.00 x	—	57285	U002	85.00 x	105.00 x	— x	10.00 x	—
52470	U046	84.00 x	98.00 x	— x	8.50 x	—	57286	U019	85.00 x	105.00 x	— x	10.00 x	—
57250	U007	84.00 x	98.00 x	— x	12.00 x	—	57287	U001	85.00 x	105.00 x	— x	12.00 x	—
57251	U008	84.00 x	98.00 x	— x	12.00 x	—	57288	U002	85.00 x	105.00 x	— x	12.00 x	—
57252	U	84.00 x	100.00 x	— x	6.30 x	—	57289	U004	85.00 x	105.00 x	— x	12.00 x	—
55649	U04A	84.00 x	100.00 x	— x	6.30 x	—	55561	U002	85.00 x	105.00 x	— x	13.20 x	—
57253	U008	84.00 x	100.00 x	— x	8.00 x	—	50895	U	85.00 x	105.00 x	— x	15.00 x	—



Cód	Mod	Di x	De x	Esp. x	Ha1 x	Ha2	Cód	Mod	Di x	De x	Esp. x	Ha1 x	Ha2
50919	U040	85.00 x	105.00 x	— x	15.00 x	—	50408	U004	87.31 x	98.42 x	— x	11.91 x	—
57290	U001	85.00 x	105.00 x	— x	18.00 x	—	57324	U004	87.31 x	101.16 x	— x	11.11 x	—
57291	U002	85.00 x	105.00 x	— x	18.00 x	—	50335	U021	87.31 x	101.60 x	— x	7.94 x	—
6303	CH	85.00 x	105.00 x	— x	28.00 x	—	51919	U005	87.50 x	101.00 x	— x	9.50 x	—
50807	U002	85.00 x	110.00 x	— x	12.00 x	—	57326	U005	87.50 x	101.00 x	— x	9.50 x	—
57292	U019	85.00 x	110.00 x	— x	12.00 x	—	55544	U007	87.50 x	101.00 x	— x	9.50 x	—
57294	U002	85.00 x	110.00 x	— x	15.00 x	—	51594	U002	87.50 x	105.00 x	— x	9.00 x	—
57293	U002	85.00 x	110.00 x	— x	15.00 x	—	52943	U	88.00 x	98.00 x	— x	8.50 x	—
50617	U004	85.00 x	110.00 x	— x	15.00 x	—	52943	U006	88.00 x	98.00 x	— x	8.50 x	—
F4716	J	85.00 x	110.00 x	— x	16.00 x	21.00	57327	U	88.00 x	100.00 x	— x	5.50 x	8.50
57295	U001	85.00 x	110.00 x	— x	22.00 x	—	50637	U021	88.00 x	100.00 x	— x	5.50 x	8.50
57296	U002	85.00 x	110.00 x	— x	22.00 x	—	57328	U001	88.00 x	100.00 x	— x	6.00 x	—
6050	CH	85.00 x	110.00 x	— x	47.50 x	—	57329	U002	88.00 x	100.00 x	— x	6.00 x	—
57297	U002	85.00 x	115.00 x	— x	15.00 x	—	52242	U008	88.00 x	100.00 x	— x	8.00 x	—
52328	U003	85.00 x	115.00 x	— x	15.00 x	—	57330	U008	88.00 x	100.00 x	— x	8.00 x	—
57298	U019	85.00 x	115.00 x	— x	15.00 x	—	57331	U002	88.00 x	100.00 x	— x	8.50 x	—
3230	C	85.00 x	120.00 x	3.00 x	15.00 x	—	50637	U021	88.00 x	100.00 x	— x	8.50 x	5.50
57299	U001	85.00 x	120.00 x	— x	17.50 x	—	53500	U031	88.00 x	100.00 x	— x	8.50 x	—
57300	U002	85.00 x	120.00 x	— x	17.50 x	—	57332	U001	88.00 x	100.00 x	— x	12.00 x	—
57301	U001	85.00 x	123.00 x	— x	12.00 x	—	57333	U002	88.00 x	100.00 x	— x	12.00 x	—
57302	U002	85.00 x	123.00 x	— x	12.00 x	—	57334	U	88.00 x	101.00 x	— x	7.60 x	9.00
—	CH	85.00 x	123.00 x	— x	63.00 x	—	50513	U008	88.00 x	101.00 x	— x	7.60 x	9.00
57303	U001	85.00 x	125.00 x	— x	20.00 x	—	—	U04A	88.00 x	102.00 x	— x	10.50 x	—
57304	U002	85.00 x	125.00 x	— x	20.00 x	—	57335	U005	88.00 x	103.00 x	— x	9.50 x	—
—	CH	85.20 x	99.70 x	— x	21.00 x	—	57336	U002	88.00 x	103.00 x	— x	12.00 x	—
57305	U004	85.50 x	98.50 x	— x	9.00 x	—	50709	U045	88.00 x	103.00 x	— x	12.00 x	8.00
57306	U002	85.50 x	110.50 x	— x	12.50 x	—	8389	V	88.00 x	105.00 x	— x	6.00 x	—
52824	U	85.60 x	101.60 x	— x	8.00 x	—	51003	U004	88.00 x	105.00 x	— x	8.00 x	—
55582	U031	85.60 x	101.60 x	— x	13.50 x	—	57337	U001	88.00 x	105.00 x	— x	10.00 x	—
51363	U007	85.72 x	101.60 x	— x	7.94 x	—	57338	U002	88.00 x	105.00 x	— x	10.00 x	—
51331	U002	85.72 x	101.60 x	— x	12.70 x	—	—	CH	88.00 x	105.00 x	— x	30.00 x	—
51098	U004	85.72 x	101.60 x	— x	12.70 x	—	57339	U001	88.00 x	108.00 x	— x	6.00 x	—
—	U04A	85.73 x	98.43 x	— x	9.52 x	—	57340	U002	88.00 x	108.00 x	— x	6.00 x	—
57307	U019	85.73 x	104.78 x	— x	9.53 x	—	57341	U004	88.00 x	108.00 x	— x	12.00 x	—
—	U04A	85.73 x	104.80 x	— x	9.52 x	—	51198	U	88.00 x	108.00 x	— x	15.50 x	—
—	U04A	85.73 x	108.00 x	— x	15.87 x	—	—	CH	88.00 x	108.00 x	— x	40.00 x	—
50829	U	86.00 x	92.00 x	— x	3.50 x	—	57343	U002	88.00 x	110.00 x	— x	15.00 x	—
50672	U013	86.00 x	96.00 x	— x	9.00 x	—	57342	U003	88.00 x	110.00 x	— x	15.00 x	—
50755	U065	86.00 x	96.00 x	— x	14.00 x	—	55660	U002	88.00 x	118.00 x	— x	15.00 x	—
50762	U006	86.00 x	98.00 x	— x	11.50 x	10.50	57344	U002	88.00 x	118.00 x	— x	15.00 x	—
57308	U001	86.00 x	98.00 x	— x	12.00 x	—	53086	U053	88.00 x	120.00 x	— x	13.00 x	—
57309	U002	86.00 x	98.00 x	— x	12.00 x	—	57345	U001	88.00 x	125.00 x	— x	15.00 x	—
55753	U004	86.00 x	100.00 x	— x	9.50 x	—	57346	U002	88.00 x	125.00 x	— x	15.00 x	—
57310	U007	86.00 x	100.00 x	— x	16.00 x	—	50612	U005	88.50 x	102.50 x	— x	8.70 x	—
57311	U008	86.00 x	100.00 x	— x	16.00 x	—	51303	U	88.70 x	104.80 x	— x	9.00 x	—
57312	U004	86.00 x	104.00 x	— x	12.00 x	—	51198	U031	88.80 x	108.00 x	— x	15.50 x	—
6217	CH	86.00 x	112.00 x	— x	31.00 x	—	50265	U019	88.85 x	99.15 x	— x	6.00 x	—
3413	C	86.00 x	126.00 x	4.00 x	12.00 x	—	50949	U031	88.90 x	95.25 x	— x	5.50 x	—
51479	U	86.50 x	98.00 x	— x	8.50 x	—	57347	U005	88.90 x	96.84 x	— x	13.49 x	—
57313	U002	86.50 x	100.00 x	— x	12.00 x	—	57348	U006	88.90 x	96.84 x	— x	13.49 x	—
57314	U004	86.50 x	101.00 x	— x	11.50 x	—	50458	U024	88.90 x	96.84 x	— x	15.00 x	—
57315	U007	86.50 x	101.50 x	— x	12.00 x	—	50859	U031	88.90 x	101.60 x	— x	6.35 x	—
52432	U002	86.50 x	105.00 x	— x	9.52 x	—	50859	U031	88.90 x	101.60 x	— x	6.35 x	—
57316	U004	86.50 x	106.00 x	— x	14.50 x	—	53107	U04A	88.90 x	101.60 x	— x	6.35 x	—
8234	V	86.50 x	120.00 x	— x	9.50 x	—	53107	U04A	88.90 x	101.60 x	— x	6.35 x	—
3304	C	86.50 x	124.00 x	— x	12.00 x	—	52060	U	88.90 x	101.60 x	— x	9.50 x	—
57317	U008	86.60 x	101.50 x	— x	12.00 x	—	52060	U047	88.90 x	101.60 x	— x	9.50 x	—
57318	U007	87.00 x	100.00 x	— x	9.00 x	—	57351	U004	88.90 x	101.60 x	— x	11.91 x	—
59346	U004	87.00 x	101.00 x	— x	8.50 x	—	—	CH	88.90 x	101.60 x	— x	25.00 x	—
57319	U008	87.00 x	101.00 x	— x	12.00 x	—	6001	CH	88.90 x	101.60 x	— x	31.75 x	—
57320	U002	87.00 x	103.00 x	— x	14.00 x	—	—	CH	88.90 x	101.60 x	— x	37.00 x	—
—	CH	87.00 x	107.00 x	— x	46.00 x	—	6285	CH	88.90 x	104.78 x	— x	24.00 x	—
57321	U002	87.00 x	109.00 x	— x	12.00 x	—	6285	CH	88.90 x	104.78 x	— x	33.00 x	—
57322	U001	87.00 x	114.50 x	— x	13.00 x	—	—	U04A	88.90 x	104.80 x	— x	12.70 x	—
50611	U065	87.00 x	115.00 x	— x	14.00 x	—	57352	U001	88.90 x	106.76 x	— x	15.08 x	—
57323	U	87.31 x	98.42 x	— x	6.00 x	8.73	57353	U002	88.90 x	106.76 x	— x	15.08 x	—
50533	U003	87.31 x	98.42 x	— x	8.73 x	6.00	53204	U04A	88.90 x	107.90 x	— x	9.50 x	—



Cód	Mod	Di x	De x	Esp. x	Ha1 x	Ha2	Cód	Mod	Di x	De x	Esp. x	Ha1 x	Ha2
8102	V	88.90 x	107.95 x	— x	9.30 x	—	57377	U006	90.00 x	100.00 x	— x	12.50 x	—
57354	U019	88.90 x	107.95 x	— x	9.53 x	—	57378	U007	90.00 x	100.00 x	— x	14.00 x	—
50809	U	88.90 x	107.95 x	— x	11.90 x	—	57379	U008	90.00 x	100.00 x	— x	14.00 x	—
50809	U004	88.90 x	107.95 x	— x	11.90 x	—	57380	U008	90.00 x	100.00 x	— x	14.00 x	—
57355	U007	88.90 x	107.95 x	— x	12.70 x	—	51460	U	90.00 x	101.00 x	— x	8.00 x	—
57356	U008	88.90 x	107.95 x	— x	12.70 x	—	51460	U031	90.00 x	101.00 x	— x	8.00 x	—
57357	U008	88.90 x	107.95 x	— x	12.70 x	—	57381	U001	90.00 x	101.00 x	— x	15.00 x	—
6463	CH	88.90 x	107.95 x	— x	42.00 x	—	57382	U002	90.00 x	101.00 x	— x	15.00 x	—
—	U04A	88.90 x	108.00 x	— x	15.87 x	—	USINADO U04A	90.00 x	101.60 x	— x	7.00 x	—	—
6047	CH	88.90 x	108.00 x	— x	23.81 x	—	57383	U002	90.00 x	102.00 x	— x	7.00 x	—
56897	U04A	88.90 x	114.30 x	— x	19.05 x	—	50760	U	90.00 x	102.00 x	— x	10.00 x	7.50
6337	CH	88.90 x	114.30 x	— x	48.00 x	—	52713	U04A	90.00 x	102.50 x	— x	6.35 x	—
53002	U	88.90 x	120.65 x	— x	12.70 x	—	52713	U04A	90.00 x	102.50 x	— x	6.35 x	—
53002	U015	88.90 x	120.65 x	— x	12.70 x	—	57384	U006	90.00 x	103.00 x	— x	9.00 x	—
59304	U04A	88.90 x	120.65 x	— x	15.88 x	—	52785	U	90.00 x	103.00 x	— x	10.00 x	—
—	CH	88.90 x	127.00 x	— x	46.00 x	—	57385	U002	90.00 x	105.00 x	— x	6.00 x	—
—	CH	88.90 x	127.00 x	— x	63.00 x	—	57386	U001	90.00 x	105.00 x	— x	7.50 x	—
3133	C	88.90 x	149.42 x	9.00 x	34.92 x	—	57387	U002	90.00 x	105.00 x	— x	7.50 x	—
57358	U004	88.90 x	170.95 x	— x	15.08 x	—	52565	U04A	90.00 x	105.00 x	— x	9.00 x	—
57359	U019	89.00 x	99.00 x	— x	9.00 x	—	57388	U004	90.00 x	105.00 x	— x	12.00 x	—
57360	U002	89.00 x	100.00 x	— x	6.50 x	—	6213	CH	90.00 x	105.00 x	— x	22.00 x	—
57361	U006	89.00 x	101.00 x	— x	9.00 x	—	57389	U004	90.00 x	109.50 x	— x	13.50 x	—
50917	U002	89.00 x	102.00 x	— x	6.20 x	—	51427	U	90.00 x	110.00 x	— x	10.00 x	—
50917	U002	89.00 x	102.00 x	— x	6.20 x	—	57390	U002	90.00 x	110.00 x	— x	10.00 x	—
50874	U002	89.00 x	102.00 x	— x	8.50 x	—	50097	U004	90.00 x	110.00 x	— x	10.00 x	—
57362	U002	89.00 x	102.00 x	— x	8.50 x	—	57391	U004	90.00 x	110.00 x	— x	10.00 x	—
53238	U031	89.00 x	102.40 x	— x	12.00 x	—	50912	U004	90.00 x	110.00 x	— x	10.00 x	—
52063	U002	89.00 x	103.00 x	— x	7.00 x	—	57392	U007	90.00 x	110.00 x	— x	10.00 x	—
52063	U002	89.00 x	103.00 x	— x	7.00 x	—	57393	U019	90.00 x	110.00 x	— x	10.00 x	—
53354	U04A	89.00 x	103.00 x	— x	7.00 x	—	57394	U031	90.00 x	110.00 x	— x	10.00 x	—
55740	U004	89.00 x	107.00 x	— x	12.00 x	—	50967	U	90.00 x	110.00 x	— x	12.00 x	—
55740	U004	89.00 x	107.00 x	— x	12.00 x	—	50967	U002	90.00 x	110.00 x	— x	12.00 x	—
—	CH	89.00 x	108.00 x	— x	29.00 x	—	50782	U056	90.00 x	110.00 x	— x	12.00 x	—
55688	U	89.00 x	110.00 x	— x	11.50 x	—	8132	V	90.00 x	110.00 x	— x	12.00 x	—
57363	U001	89.00 x	120.00 x	— x	11.00 x	—	51520	U	90.00 x	110.00 x	— x	15.00 x	—
57364	U002	89.00 x	120.00 x	— x	11.00 x	—	57395	U002	90.00 x	110.00 x	— x	17.00 x	—
6045	CH	89.10 x	102.30 x	— x	5.70 x	—	52061	U002	90.00 x	110.00 x	— x	18.00 x	—
8039	V	89.30 x	101.60 x	— x	6.35 x	—	59462	U	90.00 x	110.00 x	— x	20.00 x	—
6323	CH	89.40 x	120.00 x	— x	34.00 x	—	6386	CH	90.00 x	110.00 x	— x	30.00 x	—
57365	U031	89.50 x	99.00 x	— x	6.50 x	—	6104	CH	90.00 x	110.00 x	— x	45.00 x	—
57366	U002	89.50 x	101.00 x	— x	6.50 x	—	6104	CH	90.00 x	110.00 x	— x	45.00 x	—
57367	U001	89.50 x	108.50 x	— x	10.00 x	—	57396	U002	90.00 x	112.00 x	— x	10.00 x	—
57368	U002	89.50 x	112.00 x	— x	10.00 x	—	52652	U	90.00 x	112.50 x	— x	12.70 x	—
57369	U004	89.50 x	115.00 x	— x	15.00 x	—	57397	U001	90.00 x	114.00 x	— x	8.00 x	—
57370	U003	89.50 x	120.50 x	— x	15.00 x	—	57398	U002	90.00 x	114.00 x	— x	8.00 x	—
52555	U004	89.90 x	122.20 x	— x	15.00 x	—	57399	U004	90.00 x	114.00 x	— x	15.00 x	—
57371	U004	90.00 x	22.00 x	— x	8.50 x	—	57400	U001	90.00 x	115.00 x	— x	12.00 x	—
53103	U002	90.00 x	55.00 x	— x	9.00 x	—	57401	U002	90.00 x	115.00 x	— x	12.00 x	—
53533	U056	90.00 x	97.00 x	— x	5.70 x	—	50848	U	90.00 x	115.00 x	— x	15.00 x	—
51803	UL	90.00 x	98.00 x	— x	7.50 x	6.00	57402	U001	90.00 x	115.00 x	— x	22.00 x	—
53427	U032	90.00 x	100.00 x	— x	4.30 x	—	57403	U002	90.00 x	115.00 x	— x	22.00 x	—
53427	U032	90.00 x	100.00 x	— x	4.30 x	—	6197	CH	90.00 x	115.00 x	— x	42.50 x	—
50822	U031	90.00 x	100.00 x	— x	6.50 x	—	—	CH	90.00 x	116.00 x	— x	48.00 x	—
50822	U031	90.00 x	100.00 x	— x	6.50 x	—	50954	U	90.00 x	120.00 x	— x	13.00 x	—
8313	V	90.00 x	100.00 x	— x	9.00 x	—	50954	U003	90.00 x	120.00 x	— x	13.00 x	—
52972	U	90.00 x	100.00 x	— x	9.50 x	—	50954	U003	90.00 x	120.00 x	— x	13.00 x	—
52972	U04A	90.00 x	100.00 x	— x	9.50 x	—	57404	U002	90.00 x	120.00 x	— x	15.00 x	—
52972	U04A	90.00 x	100.00 x	— x	9.50 x	—	50311	U003	90.00 x	120.00 x	— x	15.00 x	—
57372	U001	90.00 x	100.00 x	— x	10.00 x	—	57405	U003	90.00 x	120.00 x	— x	15.00 x	—
57373	U007	90.00 x	100.00 x	— x	10.00 x	—	57406	U019	90.00 x	120.00 x	— x	15.00 x	—
52157	U	90.00 x	100.00 x	— x	10.50 x	—	53267	U002	90.00 x	120.00 x	— x	16.00 x	—
57374	U007	90.00 x	100.00 x	— x	10.50 x	—	57407	U004	90.00 x	120.00 x	— x	18.00 x	—
57375	U008	90.00 x	100.00 x	— x	10.50 x	—	53190	U031	90.00 x	120.00 x	— x	20.00 x	—
52142	U	90.00 x	100.00 x	— x	11.00 x	—	6105	CH	90.00 x	120.00 x	— x	43.00 x	—
52647	U008	90.00 x	100.00 x	— x	11.00 x	—	—	CH	90.00 x	120.00 x	— x	66.50 x	—
52647	U008	90.00 x	100.00 x	— x	11.00 x	—	57408	U001	90.00 x	125.00 x	— x	10.00 x	—
57376	U005	90.00 x	100.00 x	— x	11.80 x	—	57409	U002	90.00 x	125.00 x	— x	10.00 x	—



Cód	Mod	Di x	De x	Esp. x	Ha1 x	Ha2	Cód	Mod	Di x	De x	Esp. x	Ha1 x	Ha2
57410	U001	90.00 x	125.00 x	— x	15.00 x	—	57440	U006	93.00 x	104.00 x	— x	13.50 x	—
57411	U002	90.00 x	125.00 x	— x	15.00 x	—	50282	U008	93.00 x	104.70 x	— x	8.00 x	—
57412	U001	90.00 x	125.00 x	— x	17.50 x	—	8374	V	93.00 x	106.00 x	— x	9.00 x	—
57413	U002	90.00 x	125.00 x	— x	17.50 x	—	8374	V	93.00 x	106.00 x	— x	9.50 x	—
57414	U001	90.00 x	128.00 x	— x	19.00 x	—	8073	V	93.00 x	110.00 x	— x	10.00 x	—
57415	U002	90.00 x	128.00 x	— x	19.00 x	—	57441	U008	93.00 x	110.00 x	— x	16.00 x	—
52026	U002	90.00 x	130.00 x	— x	15.00 x	—	—	CH	93.00 x	113.00 x	— x	42.00 x	—
57416	U002	90.00 x	130.00 x	— x	15.00 x	—	57442	U001	93.00 x	120.00 x	— x	15.00 x	—
52026	U002	90.00 x	130.00 x	— x	15.00 x	—	57443	U002	93.00 x	120.00 x	— x	15.00 x	—
57417	U019	90.49 x	107.95 x	— x	7.94 x	—	53014	U	93.00 x	125.00 x	— x	14.00 x	—
8016	V	90.49 x	120.65 x	— x	14.29 x	—	57444	U005	93.20 x	105.00 x	— x	15.00 x	—
57418	U001	90.49 x	120.65 x	— x	20.64 x	—	57445	U006	93.20 x	105.00 x	— x	15.00 x	—
57419	U007	90.50 x	100.50 x	— x	9.00 x	—	57446	U019	93.50 x	107.00 x	— x	8.00 x	—
50987	U	90.50 x	101.60 x	— x	9.00 x	—	—	CH	93.50 x	129.00 x	— x	70.50 x	—
57420	U004	90.50 x	110.00 x	— x	12.50 x	—	—	CH	93.66 x	106.36 x	— x	29.00 x	—
53089	U	90.50 x	117.50 x	— x	16.00 x	—	50416	U029	93.66 x	117.47 x	— x	10.00 x	—
51329	U031	90.50 x	136.00 x	— x	27.00 x	—	53335	U031	94.00 x	101.60 x	— x	6.00 x	—
51329	U031	90.50 x	136.00 x	— x	27.00 x	—	57447	U001	94.00 x	108.00 x	— x	7.00 x	—
51329	U031	90.50 x	136.00 x	— x	27.00 x	—	57448	U002	94.00 x	108.00 x	— x	7.00 x	—
52372	U	91.00 x	101.00 x	— x	6.00 x	5.00	55653	U	94.00 x	110.00 x	— x	6.30 x	—
51883	U	91.00 x	101.60 x	— x	9.00 x	—	53466	U001	94.00 x	110.00 x	— x	8.00 x	—
51878	U001	91.00 x	101.60 x	— x	9.00 x	—	57449	U002	94.00 x	110.00 x	— x	8.00 x	—
57421	U007	91.00 x	107.00 x	— x	10.00 x	—	57450	U001	94.00 x	120.00 x	— x	12.00 x	—
57422	U008	91.00 x	107.00 x	— x	10.00 x	—	57451	U002	94.00 x	120.00 x	— x	12.00 x	—
52789	U	91.00 x	108.00 x	— x	11.00 x	—	57452	U001	94.00 x	123.50 x	— x	15.00 x	—
53088	U	91.00 x	110.00 x	— x	10.00 x	—	57453	U019	94.50 x	119.00 x	— x	10.00 x	—
53014	U003	91.00 x	123.00 x	— x	14.00 x	—	57454	U002	94.50 x	119.50 x	— x	21.50 x	—
59317	U002	91.50 x	101.00 x	— x	6.35 x	—	57455	U001	94.50 x	119.70 x	— x	21.50 x	—
57424	U031	91.50 x	110.00 x	— x	17.00 x	—	57456	U002	94.50 x	120.50 x	— x	21.50 x	—
8074	V	91.80 x	121.50 x	— x	16.00 x	—	57457	U001	94.50 x	120.70 x	— x	21.50 x	—
57425	U001	92.00 x	100.00 x	— x	8.00 x	—	—	CH	94.50 x	124.50 x	— x	53.00 x	—
57426	U002	92.00 x	100.00 x	— x	8.00 x	—	51596	U	95.00 x	103.00 x	— x	12.00 x	—
53072	U004	92.00 x	101.60 x	— x	4.70 x	—	57458	U005	95.00 x	103.00 x	— x	12.00 x	—
51037	U	92.00 x	101.60 x	— x	9.50 x	—	57459	U006	95.00 x	103.00 x	— x	12.00 x	—
53356	U002	92.00 x	105.00 x	— x	8.00 x	—	52606	U	95.00 x	104.50 x	— x	9.50 x	—
57427	U031	92.00 x	105.00 x	— x	8.00 x	—	52606	U04A	95.00 x	104.50 x	— x	9.50 x	—
57428	U004	92.00 x	106.50 x	— x	8.50 x	—	52566	U	95.00 x	105.00 x	— x	11.50 x	—
8054	V	92.00 x	107.00 x	— x	6.00 x	—	52566	U003	95.00 x	105.00 x	— x	11.50 x	—
52174	U04A	92.00 x	115.00 x	— x	19.00 x	—	57460	U007	95.00 x	105.00 x	— x	12.00 x	—
57429	U001	92.00 x	116.00 x	— x	12.00 x	—	57461	U008	95.00 x	105.00 x	— x	12.00 x	—
57430	U002	92.00 x	116.00 x	— x	12.00 x	—	57462	U007	95.00 x	105.00 x	— x	15.00 x	—
57431	U001	92.00 x	120.00 x	— x	15.00 x	—	57463	U008	95.00 x	105.00 x	— x	15.00 x	—
57432	U002	92.00 x	120.00 x	— x	15.00 x	—	50170	U004	95.00 x	109.00 x	— x	12.00 x	—
57433	U001	92.00 x	121.00 x	— x	15.00 x	—	50156	U004	95.00 x	109.00 x	— x	12.00 x	—
57434	U002	92.00 x	121.00 x	— x	15.00 x	—	50156	U004	95.00 x	109.00 x	— x	12.00 x	—
57435	U004	92.00 x	121.00 x	— x	18.00 x	—	59373	UL	95.00 x	110.00 x	— x	4.00 x	8.50
57436	U001	92.00 x	125.00 x	— x	16.00 x	—	8327	V	95.00 x	110.00 x	— x	5.00 x	—
57437	U002	92.00 x	125.00 x	— x	16.00 x	—	57464	U002	95.00 x	110.00 x	— x	6.50 x	—
52317	U004	92.07 x	101.60 x	— x	4.72 x	—	57465	U001	95.00 x	110.00 x	— x	7.50 x	—
50355	U094	92.07 x	105.57 x	— x	6.35 x	—	50235	U002	95.00 x	110.00 x	— x	7.50 x	—
8157	V	92.07 x	114.30 x	— x	12.70 x	—	52892	U	95.00 x	110.00 x	— x	8.00 x	—
3171	C	92.07 x	127.00 x	3.17 x	15.87 x	—	52892	U	95.00 x	110.00 x	— x	8.00 x	—
3124	C	92.07 x	152.40 x	3.17 x	15.87 x	—	52874	U004	95.00 x	110.00 x	— x	8.00 x	—
3096	C	92.07 x	245.67 x	4.76 x	19.05 x	—	57466	U007	95.00 x	110.00 x	— x	8.00 x	—
52119	U002	92.08 x	104.78 x	— x	6.35 x	—	51886	U012	95.00 x	110.00 x	— x	8.50 x	7.00
52292	U004	92.08 x	104.78 x	— x	9.53 x	—	8392	V	95.00 x	110.00 x	— x	9.00 x	—
52292	U004	92.08 x	104.78 x	— x	9.53 x	—	51014	U	95.00 x	110.00 x	— x	10.00 x	—
—	U04A	92.08 x	111.10 x	— x	15.87 x	—	52269	U	95.00 x	110.00 x	— x	10.00 x	—
52361	U019	92.08 x	111.13 x	— x	9.50 x	—	57467	U008	95.00 x	110.00 x	— x	10.00 x	—
52361	U	92.08 x	111.13 x	— x	9.53 x	—	8396	V	95.00 x	110.00 x	— x	10.00 x	—
57438	U019	92.08 x	111.13 x	— x	9.53 x	—	51632	U	95.00 x	110.00 x	— x	12.00 x	—
53171	U002	92.20 x	114.30 x	— x	9.50 x	—	50148	U004	95.00 x	110.00 x	— x	12.00 x	—
50289	U066	92.30 x	102.50 x	— x	7.00 x	—	57468	U001	95.00 x	110.00 x	— x	15.00 x	—
50707	U	92.50 x	111.50 x	— x	16.50 x	—	57469	U002	95.00 x	110.00 x	— x	15.00 x	—
51698	U	92.50 x	116.50 x	— x	7.50 x	—	6246	CH	95.00 x	110.00 x	— x	16.00 x	—
52484	U024	93.00 x	103.00 x	— x	15.00 x	—	51624	U	95.00 x	114.00 x	— x	7.50 x	—
57439	U005	93.00 x	104.00 x	— x	13.50 x	—	57470	U004	95.00 x	114.00 x	— x	12.00 x	—





Cód	Mod	Di x	De x	Esp. x	Ha1 x	Ha2	Cód	Mod	Di x	De x	Esp. x	Ha1 x	Ha2
52211	U002	95.00 x	115.00 x	— x	10.00 x	—	57510	U001	96.00 x	130.00 x	— x	16.00 x	—
57471	U002	95.00 x	115.00 x	— x	10.00 x	—	57511	U002	96.00 x	130.00 x	— x	16.00 x	—
57472	U019	95.00 x	115.00 x	— x	10.00 x	—	57512	U001	97.00 x	105.00 x	— x	8.00 x	—
3274	C	95.00 x	115.00 x	— x	11.00 x	—	57513	U002	97.00 x	105.00 x	— x	8.00 x	—
57473	U004	95.00 x	115.00 x	— x	11.00 x	—	57514	U019	97.00 x	105.00 x	— x	13.00 x	—
53375	U004	95.00 x	115.00 x	— x	12.00 x	—	57515	U005	97.00 x	105.00 x	— x	13.50 x	—
57474	U004	95.00 x	115.00 x	— x	13.00 x	—	57516	U006	97.00 x	105.00 x	— x	13.50 x	—
57475	U019	95.00 x	115.00 x	— x	14.00 x	—	50139	U006	97.00 x	105.00 x	— x	14.00 x	—
52620	U	95.00 x	115.00 x	— x	15.00 x	—	50623	U024	97.00 x	108.00 x	— x	15.00 x	—
57476	U001	95.00 x	115.00 x	— x	18.00 x	—	—	U04A	97.00 x	110.00 x	— x	10.00 x	—
57477	U002	95.00 x	115.00 x	— x	18.00 x	—	—	CH	97.00 x	119.00 x	— x	38.00 x	—
51927	U002	95.00 x	118.30 x	— x	10.00 x	—	51451	U002	97.00 x	121.00 x	— x	8.00 x	—
57478	U002	95.00 x	119.00 x	— x	12.00 x	—	57517	U003	97.00 x	126.00 x	— x	13.00 x	—
8137	V	95.00 x	120.00 x	— x	11.00 x	—	52227	U031	97.00 x	145.00 x	— x	27.00 x	—
8269	V	95.00 x	120.00 x	— x	11.50 x	—	52199	U004	97.50 x	116.00 x	— x	10.50 x	—
53058	U002	95.00 x	120.00 x	— x	12.00 x	—	57518	U001	97.50 x	136.00 x	— x	20.00 x	—
57479	U002	95.00 x	120.00 x	— x	12.00 x	—	57519	U002	97.50 x	136.00 x	— x	20.00 x	—
53058	U002	95.00 x	120.00 x	— x	12.00 x	—	—	CH	97.63 x	124.62 x	— x	171.50 x	—
57480	U004	95.00 x	120.00 x	— x	12.00 x	—	57520	U007	98.00 x	105.00 x	— x	8.00 x	—
57481	U004	95.00 x	120.00 x	— x	15.00 x	—	57521	U008	98.00 x	105.00 x	— x	8.00 x	—
57482	U002	95.00 x	120.00 x	— x	18.00 x	—	50582	U024	98.00 x	106.00 x	— x	14.50 x	—
57483	U001	95.00 x	120.00 x	— x	20.00 x	—	57522	U002	98.00 x	108.00 x	— x	10.00 x	—
53636	U002	95.00 x	120.00 x	— x	20.00 x	—	52163	U024	98.00 x	108.00 x	— x	10.00 x	—
6105	CH	95.00 x	120.00 x	— x	32.00 x	—	57523	U005	98.00 x	108.00 x	— x	13.50 x	—
6105	CH	95.00 x	120.00 x	— x	32.00 x	—	57524	U006	98.00 x	108.00 x	— x	13.50 x	—
53460	U	95.00 x	120.60 x	— x	12.70 x	—	57525	U001	98.00 x	110.00 x	— x	6.00 x	—
53460	U	95.00 x	120.60 x	— x	12.70 x	—	57526	U002	98.00 x	110.00 x	— x	6.00 x	—
57484	U002	95.00 x	125.00 x	— x	15.00 x	—	53534	U014	98.00 x	110.00 x	— x	8.00 x	—
51957	U003	95.00 x	125.00 x	— x	15.00 x	—	57527	U001	98.00 x	110.00 x	— x	12.00 x	—
57485	U019	95.00 x	125.00 x	— x	15.00 x	—	57528	U002	98.00 x	110.00 x	— x	12.00 x	—
53082	U04A	95.00 x	125.00 x	— x	21.00 x	—	—	U04A	98.00 x	112.00 x	— x	10.50 x	—
51327	U	95.00 x	127.20 x	— x	19.00 x	—	57529	U001	98.00 x	113.00 x	— x	7.50 x	—
50494	U019	95.00 x	127.20 x	— x	19.00 x	—	57530	U002	98.00 x	113.00 x	— x	7.50 x	—
57486	U001	95.00 x	130.00 x	— x	20.00 x	—	—	CH	98.00 x	113.00 x	— x	48.50 x	—
57487	U002	95.00 x	130.00 x	— x	20.00 x	—	57531	U003	98.00 x	115.00 x	— x	10.00 x	—
57488	U001	95.00 x	135.00 x	— x	20.00 x	—	—	CH	98.00 x	119.00 x	— x	33.50 x	—
57489	U002	95.00 x	135.00 x	— x	20.00 x	—	57532	U001	98.00 x	122.00 x	— x	12.00 x	—
57500	U001	95.00 x	140.00 x	— x	16.00 x	—	57533	U002	98.00 x	122.00 x	— x	12.00 x	—
57501	U001	95.20 x	120.70 x	— x	15.00 x	—	57534	U001	98.00 x	122.00 x	— x	15.00 x	—
57502	U002	95.25 x	106.36 x	— x	6.35 x	—	57535	U002	98.00 x	122.00 x	— x	15.00 x	—
52854	U031	95.25 x	108.00 x	— x	14.28 x	—	F9288	J	98.00 x	127.30 x	— x	26.00 x	—
52854	U031	95.25 x	108.00 x	— x	14.28 x	—	57536	U001	98.00 x	130.00 x	— x	16.00 x	—
57503	U005	95.25 x	111.13 x	— x	9.53 x	—	57537	U002	98.00 x	130.00 x	— x	16.00 x	—
52441	U	95.25 x	111.13 x	— x	12.70 x	—	52420	U	98.20 x	107.00 x	— x	5.00 x	—
52441	U04A	95.25 x	111.13 x	— x	12.70 x	—	6402	CH	98.42 x	123.82 x	— x	28.00 x	—
52732	U	95.25 x	114.30 x	— x	7.94 x	—	52344	U	98.43 x	111.13 x	— x	9.50 x	—
—	U04A	95.25 x	114.30 x	— x	9.52 x	—	52049	U	98.43 x	114.30 x	— x	12.70 x	—
57504	U002	95.25 x	114.30 x	— x	9.53 x	—	57538	U019	98.43 x	117.48 x	— x	9.53 x	—
57505	U019	95.25 x	114.30 x	— x	9.53 x	—	—	CH	98.43 x	117.48 x	— x	35.00 x	—
50712	U026	95.25 x	114.30 x	— x	12.70 x	—	—	CH	98.43 x	123.83 x	— x	51.00 x	—
—	U04A	95.25 x	114.30 x	— x	15.87 x	—	3227	C001	98.43 x	127.00 x	3.50 x	14.28 x	—
6025	CH	95.25 x	114.30 x	— x	28.58 x	—	51738	U	98.50 x	108.50 x	— x	9.50 x	—
8250	V	95.25 x	120.65 x	— x	12.50 x	—	51954	U088	98.50 x	117.50 x	— x	15.00 x	9.00
57506	U002	95.25 x	120.65 x	— x	15.08 x	—	52847	U	98.50 x	122.00 x	— x	12.70 x	—
56905	U04A	95.25 x	120.70 x	— x	19.05 x	—	50043	U003	98.70 x	117.50 x	— x	10.00 x	—
6048	CH	95.25 x	120.70 x	— x	44.45 x	—	53050	U	99.00 x	107.50 x	— x	7.50 x	—
52421	U	95.50 x	105.30 x	— x	7.70 x	—	53050	U006	99.00 x	107.50 x	— x	10.00 x	—
50827	U	95.60 x	108.80 x	— x	6.40 x	—	51099	U	99.00 x	112.00 x	— x	10.00 x	—
F15812	ESPE	95.80 x	118.00 x	— x	2.20 x	5.30	57539	U002	99.00 x	112.00 x	— x	10.00 x	—
59289	U004	96.00 x	100.00 x	— x	12.50 x	—	—	CH	99.00 x	115.00 x	— x	39.00 x	—
57507	U002	96.00 x	108.00 x	— x	9.00 x	—	51462	U	99.00 x	119.00 x	— x	15.00 x	12.00
52164	U	96.00 x	108.00 x	— x	12.00 x	—	57540	U001	99.00 x	120.00 x	— x	11.00 x	—
52164	U	96.00 x	108.00 x	— x	12.00 x	—	57541	U002	99.00 x	120.00 x	— x	11.00 x	—
57508	U002	96.00 x	108.00 x	— x	12.00 x	—	57542	U002	99.00 x	120.00 x	— x	18.00 x	—
55729	U	96.00 x	112.00 x	— x	10.00 x	—	50951	U026	99.00 x	121.00 x	— x	11.00 x	—
57509	U002	96.00 x	112.00 x	— x	10.00 x	—	55613	U007	99.00 x	123.50 x	— x	12.50 x	—
50628	U002	96.00 x	113.60 x	— x	9.80 x	—	55613	U007	99.00 x	123.50 x	11.60 x	12.50 x	—



Cód	Mod	Di x	De x	Esp. x	Ha1 x	Ha2	Cód	Mod	Di x	De x	Esp. x	Ha1 x	Ha2
53090	U04A	99.00 x	123.90 x	— x	12.50 x	—	57576	U005	100.00 x	120.00 x	— x	12.00 x	—
57543	U004	99.00 x	126.50 x	— x	15.00 x	—	52331	U031	100.00 x	120.00 x	— x	12.00 x	—
51712	U001	99.00 x	127.00 x	— x	9.50 x	—	52331	U031	100.00 x	120.00 x	— x	12.00 x	—
57544	U005	99.50 x	110.00 x	— x	7.00 x	—	57579	U002	100.00 x	120.00 x	— x	14.00 x	—
6099	CH	99.50 x	116.00 x	— x	23.20 x	—	51471	U	100.00 x	120.00 x	— x	15.00 x	—
57545	U002	99.50 x	120.00 x	— x	18.00 x	—	51732	U004	100.00 x	120.00 x	— x	15.00 x	—
52398	U	99.50 x	120.50 x	— x	19.50 x	16.50	57580	U001	100.00 x	120.00 x	— x	18.00 x	—
57546	U001	100.00 x	106.00 x	— x	3.00 x	—	51506	U	100.00 x	120.00 x	— x	20.00 x	—
57547	U002	100.00 x	106.00 x	— x	3.00 x	—	57581	U006	100.00 x	120.00 x	— x	20.00 x	—
53540	U	100.00 x	107.30 x	— x	6.30 x	—	6191	CH	100.00 x	120.00 x	— x	32.00 x	—
53540	U007	100.00 x	107.30 x	— x	6.35 x	—	—	CH	100.00 x	120.00 x	— x	38.00 x	—
57548	U005	100.00 x	108.00 x	— x	12.00 x	—	—	CH	100.00 x	120.00 x	— x	40.50 x	—
57549	U006	100.00 x	108.00 x	— x	12.00 x	—	—	CH	100.00 x	120.00 x	— x	61.00 x	—
57550	U005	100.00 x	109.00 x	— x	14.00 x	—	—	CH	100.00 x	120.00 x	— x	62.00 x	—
57551	U006	100.00 x	109.00 x	— x	14.00 x	—	—	CH	100.00 x	120.00 x	— x	65.50 x	—
57552	U001	100.00 x	110.00 x	— x	5.00 x	—	—	CH	100.00 x	120.65 x	— x	40.00 x	—
57553	U002	100.00 x	110.00 x	— x	5.00 x	—	57582	U001	100.00 x	122.00 x	— x	15.00 x	—
59429	U006	100.00 x	110.00 x	— x	7.00 x	—	57583	U002	100.00 x	122.00 x	— x	15.00 x	—
57554	U007	100.00 x	110.00 x	— x	8.00 x	—	3203	C	100.00 x	123.00 x	3.00 x	12.00 x	—
8340	V	100.00 x	110.00 x	— x	8.00 x	—	8410	V	100.00 x	125.00 x	— x	10.00 x	—
51274	U	100.00 x	110.00 x	— x	10.00 x	—	50652	U001	100.00 x	125.00 x	— x	12.00 x	6.00
51274	U04A	100.00 x	110.00 x	— x	10.00 x	—	57584	U002	100.00 x	125.00 x	— x	12.00 x	—
3275	C	100.00 x	110.00 x	— x	11.00 x	—	57585	U019	100.00 x	125.00 x	— x	12.00 x	—
53029	U004	100.00 x	110.00 x	— x	11.00 x	—	52860	U002	100.00 x	125.00 x	— x	12.70 x	—
52788	U031	100.00 x	110.00 x	— x	11.00 x	—	53090	U04A	100.00 x	125.00 x	— x	12.70 x	—
57555	U001	100.00 x	110.00 x	— x	12.00 x	—	57586	U005	100.00 x	125.00 x	— x	13.00 x	—
57556	U007	100.00 x	110.00 x	— x	13.50 x	—	52996	U	100.00 x	125.00 x	— x	13.50 x	—
52799	U007	100.00 x	110.00 x	— x	13.50 x	—	52996	U002	100.00 x	125.00 x	— x	13.50 x	—
57557	U008	100.00 x	110.00 x	— x	13.50 x	—	51851	U001	100.00 x	125.00 x	— x	15.00 x	7.00
57558	U005	100.00 x	110.00 x	— x	14.00 x	—	57587	U031	100.00 x	125.00 x	— x	15.00 x	—
57559	U006	100.00 x	110.00 x	— x	14.00 x	—	57589	U001	100.00 x	125.00 x	— x	22.00 x	—
57560	U001	100.00 x	112.00 x	— x	6.00 x	—	57590	U002	100.00 x	125.00 x	— x	22.00 x	—
57561	U001	100.00 x	112.00 x	— x	10.00 x	—	6236	CH	100.00 x	125.00 x	— x	24.00 x	—
57562	U002	100.00 x	112.00 x	— x	10.00 x	—	6106	CH	100.00 x	125.00 x	— x	42.50 x	—
57563	U001	100.00 x	112.00 x	— x	16.00 x	—	—	CH	100.00 x	125.00 x	— x	77.50 x	—
57564	U005	100.00 x	112.00 x	— x	16.00 x	—	—	CH	100.00 x	125.00 x	— x	161.50 x	—
57565	U006	100.00 x	112.00 x	— x	16.00 x	—	50579	U002	100.00 x	127.00 x	— x	12.00 x	—
51159	U023	100.00 x	114.00 x	— x	7.00 x	—	55630	U001	100.00 x	127.00 x	— x	15.00 x	—
52237	U	100.00 x	114.00 x	— x	9.00 x	—	57591	U002	100.00 x	127.00 x	— x	15.00 x	—
57566	U001	100.00 x	114.00 x	— x	15.00 x	—	6144	CH	100.00 x	130.00 x	— x	—	—
6220	CH	100.00 x	114.30 x	— x	23.81 x	—	8270	V	100.00 x	130.00 x	— x	7.50 x	—
51638	U003	100.00 x	115.00 x	— x	7.00 x	—	57592	U019	100.00 x	130.00 x	— x	13.00 x	—
52483	U031	100.00 x	115.00 x	— x	9.00 x	—	51598	U001	100.00 x	130.00 x	— x	15.00 x	—
57567	U001	100.00 x	115.00 x	— x	10.00 x	—	57593	U002	100.00 x	130.00 x	— x	15.00 x	—
57568	U001	100.00 x	115.00 x	— x	12.00 x	—	51671	U04A	100.00 x	130.00 x	— x	15.00 x	—
57569	U002	100.00 x	115.00 x	— x	12.00 x	—	8163	V	100.00 x	130.00 x	— x	16.00 x	—
57570	U004	100.00 x	115.00 x	— x	12.00 x	—	57594	U002	100.00 x	130.00 x	— x	17.00 x	—
6211	CH	100.00 x	115.00 x	— x	31.00 x	—	57595	U003	100.00 x	130.00 x	— x	18.00 x	—
—	CH	100.00 x	115.00 x	— x	36.00 x	—	50618	U004	100.00 x	130.00 x	— x	18.00 x	—
57571	U001	100.00 x	116.00 x	— x	11.00 x	—	57596	U004	100.00 x	130.00 x	— x	18.00 x	—
53464	U04A	100.00 x	116.00 x	— x	15.87 x	—	53081	U04A	100.00 x	132.00 x	— x	30.00 x	—
57572	U001	100.00 x	117.00 x	— x	15.00 x	—	6332	CH	100.00 x	132.00 x	— x	56.00 x	—
52198	U	100.00 x	118.00 x	— x	8.50 x	—	57597	U002	100.00 x	135.00 x	— x	15.00 x	—
51703	U002	100.00 x	118.00 x	118.00 x	12.00 x	—	57598	U001	100.00 x	135.00 x	— x	18.00 x	—
51703	U002	100.00 x	118.00 x	— x	12.00 x	—	57599	U002	100.00 x	135.00 x	— x	18.00 x	—
52693	U019	100.00 x	118.00 x	— x	12.00 x	—	57600	U001	100.00 x	140.00 x	— x	20.00 x	—
6233	CH	100.00 x	119.00 x	— x	26.00 x	—	57601	U002	100.00 x	140.00 x	— x	20.00 x	—
57573	U001	100.00 x	120.00 x	— x	10.00 x	—	53084	U04A	100.00 x	140.00 x	— x	21.00 x	—
50166	U002	100.00 x	120.00 x	— x	10.00 x	—	53084	U04A	100.00 x	140.00 x	— x	21.00 x	—
51064	U004	100.00 x	120.00 x	— x	10.00 x	—	57602	U001	100.00 x	145.00 x	— x	20.00 x	—
52503	U019	100.00 x	120.00 x	— x	10.00 x	—	57603	U002	100.00 x	145.00 x	— x	20.00 x	—
52503	U019	100.00 x	120.00 x	— x	10.00 x	—	3251	C	100.00 x	203.00 x	5.50 x	26.00 x	—
51064	U04A	100.00 x	120.00 x	— x	10.00 x	—	52232	U002	100.50 x	114.00 x	— x	10.00 x	6.00
57574	U002	100.00 x	120.00 x	— x	11.00 x	—	51505	U101	100.50 x	114.00 x	— x	10.00 x	6.00
52469	U040	100.00 x	120.00 x	— x	11.00 x	—	8017	V	100.80 x	120.20 x	— x	9.00 x	—
57575	U003	100.00 x	120.00 x	— x	12.00 x	—	53408	U031	101.00 x	113.00 x	— x	14.50 x	—
57577	U004	100.00 x	120.00 x	— x	12.00 x	—	53345	U019	101.00 x	117.50 x	— x	11.00 x	—



Cód	Mod	Di x	De x	Esp. x	Ha1 x	Ha2	Cód	Mod	Di x	De x	Esp. x	Ha1 x	Ha2
57604	U031	101.00 x	120.00 x	— x	10.00 x	—	50263	U002	102.00 x	122.00 x	— x	13.00 x	—
3330	C	101.00 x	120.00 x	— x	12.00 x	—	57624	U001	102.00 x	125.00 x	— x	10.00 x	—
51255	U005	101.00 x	120.00 x	— x	12.00 x	—	57625	U004	102.00 x	125.00 x	— x	15.00 x	—
8245	V	101.00 x	120.00 x	— x	12.00 x	—	52772	U	102.00 x	127.30 x	— x	13.00 x	—
59239	U04A	101.00 x	121.00 x	— x	17.50 x	—	52772	U04A	102.00 x	127.30 x	— x	13.00 x	—
53076	U	101.00 x	125.70 x	— x	15.70 x	—	57626	U001	102.00 x	132.00 x	— x	15.00 x	—
53461	U	101.00 x	126.90 x	— x	12.00 x	—	57627	U002	102.00 x	132.00 x	— x	15.00 x	—
53461	U	101.00 x	126.90 x	— x	12.70 x	—	57628	U001	102.00 x	145.00 x	— x	20.00 x	—
57605	U001	101.00 x	133.00 x	— x	15.00 x	—	57629	U002	102.00 x	145.00 x	— x	20.00 x	—
57606	U002	101.00 x	133.00 x	— x	15.00 x	—	57630	U005	103.00 x	112.00 x	— x	15.00 x	—
3091	C	101.00 x	160.00 x	5.50 x	15.00 x	—	57631	U006	103.00 x	112.00 x	— x	15.00 x	—
55575	U001	101.40 x	120.40 x	— x	12.70 x	—	57632	U001	103.00 x	116.00 x	— x	7.00 x	—
57607	U005	101.50 x	111.00 x	— x	8.40 x	—	57633	U007	103.00 x	120.00 x	— x	16.00 x	—
57608	U	101.50 x	114.00 x	— x	6.00 x	—	57634	U008	103.00 x	120.00 x	— x	16.00 x	—
57609	U003	101.50 x	115.00 x	— x	10.00 x	—	53242	U04A	103.00 x	126.50 x	— x	17.80 x	—
52828	U04A	101.60 x	110.00 x	— x	18.00 x	3.00	53253	U04A	103.00 x	126.50 x	— x	19.00 x	—
52828	U04A	101.60 x	110.00 x	— x	18.00 x	—	3160	C	103.00 x	129.00 x	3.00 x	16.00 x	—
50501	U080	101.60 x	110.33 x	— x	14.29 x	—	57635	U007	103.19 x	112.71 x	— x	9.13 x	—
57610	U001	101.60 x	111.00 x	— x	6.00 x	—	51655	U	103.20 x	127.00 x	— x	12.70 x	—
51453	U04A	101.60 x	111.10 x	— x	9.52 x	—	51321	U031	103.28 x	155.00 x	— x	27.00 x	—
57611	U002	101.60 x	111.13 x	— x	14.29 x	—	52025	U031	103.50 x	115.10 x	— x	6.70 x	—
52671	U031	101.60 x	112.70 x	— x	6.35 x	—	52542	U001	103.80 x	114.00 x	— x	4.40 x	—
57612	U002	101.60 x	112.71 x	— x	9.53 x	—	55666	U	103.80 x	122.80 x	— x	6.80 x	8.30
57613	U002	101.60 x	113.00 x	— x	5.50 x	—	57636	U005	104.00 x	112.00 x	— x	13.50 x	—
8190	V	101.60 x	114.30 x	— x	4.76 x	—	57637	U001	104.00 x	116.00 x	— x	8.00 x	—
50861	U002	101.60 x	114.30 x	— x	6.35 x	—	57638	U002	104.00 x	116.00 x	— x	8.00 x	—
50861	U002	101.60 x	114.30 x	— x	6.35 x	—	51015	U003	104.00 x	122.00 x	— x	12.00 x	—
50858	U	101.60 x	114.30 x	— x	9.52 x	—	57639	U003	104.00 x	125.00 x	— x	10.00 x	—
—	U04A	101.60 x	114.30 x	— x	14.28 x	—	—	CH	104.00 x	125.00 x	— x	66.50 x	—
57614	U004	101.60 x	114.30 x	— x	14.29 x	—	—	CH	104.00 x	133.50 x	— x	63.00 x	—
53439	U04A	101.60 x	114.30 x	— x	15.00 x	—	57640	U001	104.00 x	134.00 x	— x	15.00 x	—
6442	CH	101.60 x	114.30 x	— x	28.00 x	—	57641	U002	104.00 x	134.00 x	— x	15.00 x	—
—	CH	101.60 x	114.30 x	— x	35.00 x	—	—	CH	104.00 x	135.00 x	— x	30.00 x	—
57615	U002	101.60 x	115.00 x	— x	13.00 x	—	3299	C	104.00 x	152.00 x	— x	23.00 x	—
50999	U003	101.60 x	116.00 x	— x	22.00 x	20.00	3229	C	104.00 x	160.00 x	5.00 x	22.00 x	—
—	U04A	101.60 x	117.50 x	— x	14.28 x	—	57642	U031	104.70 x	128.00 x	— x	15.80 x	—
50195	U002	101.60 x	120.65 x	— x	9.52 x	—	50126	U	104.77 x	115.98 x	— x	9.52 x	—
57616	U019	101.60 x	120.65 x	— x	11.11 x	—	50606	U002	104.77 x	123.82 x	— x	15.87 x	—
57578	U04A	101.60 x	120.70 x	— x	15.80 x	—	8100	V	104.77 x	127.00 x	— x	10.40 x	—
—	CH	101.60 x	122.24 x	— x	39.00 x	—	57643	U019	104.78 x	120.65 x	— x	9.53 x	—
—	CH	101.60 x	123.83 x	— x	48.00 x	—	—	U04A	104.80 x	114.30 x	— x	4.76 x	—
—	CH	101.60 x	126.60 x	— x	46.50 x	—	—	U04A	104.80 x	120.70 x	— x	7.94 x	—
52430	U002	101.60 x	127.00 x	— x	6.35 x	—	—	U04A	104.80 x	123.80 x	— x	9.52 x	—
8037	V	101.60 x	127.00 x	— x	11.11 x	—	6013	CH	104.80 x	127.00 x	— x	33.34 x	—
8037	V	101.60 x	127.00 x	— x	11.11 x	—	56908	U04A	104.80 x	130.20 x	— x	19.05 x	—
F17179	ESPE	101.60 x	127.00 x	— x	12.70 x	—	57644	U006	105.00 x	113.00 x	— x	13.50 x	—
51963	U	101.60 x	127.00 x	— x	12.70 x	—	57645	U005	105.00 x	115.00 x	— x	13.50 x	—
53512	U04A	101.60 x	127.00 x	— x	12.70 x	—	53260	U006	105.00 x	115.00 x	— x	13.50 x	—
52151	U004	101.60 x	127.00 x	— x	19.05 x	—	57646	U007	105.00 x	115.00 x	— x	13.50 x	—
6044	CH	101.60 x	127.00 x	— x	44.45 x	—	57647	U008	105.00 x	115.00 x	— x	13.50 x	—
—	CH	101.60 x	127.00 x	— x	60.00 x	—	57648	U005	105.00 x	116.00 x	— x	14.00 x	—
57617	U001	101.60 x	128.59 x	— x	15.88 x	—	59407	UL	105.00 x	120.00 x	— x	7.00 x	10.00
—	C	101.60 x	152.40 x	5.00 x	19.05 x	—	51475	U002	105.00 x	120.00 x	— x	8.00 x	—
3252	C	101.60 x	152.40 x	3.97 x	19.05 x	—	57649	U002	105.00 x	120.00 x	— x	8.00 x	—
51229	U002	101.60 x	155.00 x	— x	27.50 x	—	51901	U008	105.00 x	120.00 x	— x	10.00 x	—
3119	C	101.60 x	203.20 x	— x	25.40 x	—	51901	U008	105.00 x	120.00 x	— x	10.00 x	—
57618	U006	102.00 x	111.00 x	— x	5.80 x	—	57650	U002	105.00 x	120.00 x	— x	11.00 x	—
57619	U003	102.00 x	113.00 x	— x	9.00 x	—	57651	U004	105.00 x	120.00 x	— x	15.00 x	—
57620	U002	102.00 x	114.00 x	— x	9.00 x	—	—	CH	105.00 x	120.00 x	— x	23.50 x	—
57621	U003	102.00 x	114.00 x	— x	9.00 x	—	50922	U061	105.00 x	121.00 x	— x	13.00 x	—
50072	U004	102.00 x	114.00 x	— x	15.00 x	—	59305	U007	105.00 x	123.00 x	— x	7.00 x	8.00
—	CH	102.00 x	118.00 x	— x	58.00 x	—	55733	U067	105.00 x	124.50 x	— x	6.30 x	9.30
57622	U001	102.00 x	122.00 x	— x	10.00 x	—	51314	U021	105.00 x	125.00 x	— x	7.80 x	9.00
57623	U002	102.00 x	122.00 x	— x	10.00 x	—	55673	U	105.00 x	125.00 x	— x	8.00 x	—
52773	U003	102.00 x	122.00 x	— x	12.70 x	—	57652	U001	105.00 x	125.00 x	— x	10.00 x	—
—	U04A	102.00 x	122.00 x	— x	12.70 x	—	57653	U002	105.00 x	125.00 x	— x	10.00 x	—
50263	U002	102.00 x	122.00 x	— x	13.00 x	—	57654	U003	105.00 x	125.00 x	— x	12.00 x	—



Cód	Mod	Di x	De x	Esp. x	Ha1 x	Ha2	Cód	Mod	Di x	De x	Esp. x	Ha1 x	Ha2
52057	U04A	105.00 x	125.00 x	— x	12.00 x	—	57685	U004	107.00 x	127.00 x	— x	18.00 x	—
52057	U04A	105.00 x	125.00 x	— x	12.00 x	—	59238	U004	107.00 x	128.00 x	— x	17.00 x	—
F7762	J	105.00 x	125.00 x	— x	13.00 x	18.00	—	CH	107.50 x	132.00 x	— x	58.00 x	—
F5094	J	105.00 x	125.00 x	— x	13.00 x	18.00	51009	U001	107.60 x	127.00 x	— x	10.40 x	—
52839	U002	105.00 x	125.00 x	— x	13.00 x	—	52887	U04A	107.90 x	127.00 x	— x	9.50 x	—
52839	U002	105.00 x	125.00 x	— x	13.00 x	—	8322	V	107.90 x	133.00 x	— x	12.40 x	—
51595	U033	105.00 x	125.00 x	— x	13.00 x	11.00	57686	U019	107.95 x	123.83 x	— x	7.94 x	—
50966	U	105.00 x	125.00 x	— x	15.00 x	—	57687	U007	107.95 x	123.83 x	— x	9.53 x	—
50966	U	105.00 x	125.00 x	— x	15.00 x	—	8113	V	107.95 x	127.00 x	— x	9.52 x	—
50966	U004	105.00 x	125.00 x	— x	15.00 x	—	51843	U04A	107.95 x	127.00 x	— x	9.53 x	—
51090	U006	105.00 x	125.00 x	— x	15.00 x	—	50846	U026	107.95 x	127.00 x	— x	12.70 x	—
55594	U04A	105.00 x	125.00 x	— x	15.00 x	—	—	CH	107.95 x	127.00 x	— x	43.00 x	—
53021	U001	105.00 x	125.00 x	— x	16.00 x	—	—	CH	107.95 x	133.35 x	— x	44.50 x	—
53021	U001	105.00 x	125.00 x	— x	16.00 x	—	—	CH	107.95 x	133.35 x	— x	66.00 x	—
6307	CH	105.00 x	125.00 x	— x	51.20 x	—	53539	U008	108.00 x	114.50 x	— x	6.35 x	—
50671	U002	105.00 x	126.00 x	— x	15.00 x	—	—	U04A	108.00 x	117.50 x	— x	4.76 x	—
57655	U002	105.00 x	130.00 x	— x	12.00 x	—	59322	U04A	108.00 x	120.00 x	— x	7.00 x	—
52255	U003	105.00 x	130.00 x	— x	12.00 x	—	57688	U007	108.00 x	120.00 x	— x	10.00 x	—
57656	U003	105.00 x	130.00 x	— x	12.00 x	—	53353	U04A	108.00 x	120.00 x	— x	10.00 x	—
52255	U003	105.00 x	130.00 x	— x	12.00 x	—	—	U04A	108.00 x	120.70 x	— x	6.35 x	—
57657	U004	105.00 x	130.00 x	— x	18.00 x	—	52209	U	108.00 x	122.00 x	— x	7.00 x	—
57658	U007	105.00 x	130.00 x	— x	20.00 x	—	57689	U002	108.00 x	122.00 x	— x	7.00 x	—
—	CH	105.00 x	130.00 x	— x	56.00 x	—	8407	V	108.00 x	122.00 x	— x	18.00 x	—
57659	U001	105.00 x	135.00 x	— x	15.00 x	—	52017	U	108.00 x	123.00 x	— x	10.00 x	—
57660	U002	105.00 x	135.00 x	— x	15.00 x	—	52017	U019	108.00 x	123.00 x	— x	10.00 x	—
57661	U001	105.00 x	140.00 x	— x	15.00 x	—	—	U04A	108.00 x	123.80 x	— x	14.28 x	—
57662	U002	105.00 x	140.00 x	— x	15.00 x	—	53017	U002	108.00 x	125.00 x	— x	15.00 x	—
57663	U002	105.00 x	140.00 x	— x	19.00 x	—	53017	U002	108.00 x	125.00 x	— x	15.00 x	—
57664	U001	105.00 x	140.00 x	— x	20.00 x	—	3386	C	108.00 x	126.00 x	— x	9.00 x	—
57665	U001	105.00 x	145.00 x	— x	20.00 x	—	52000	U	108.00 x	127.00 x	— x	9.50 x	—
57666	U002	105.00 x	145.00 x	— x	20.00 x	—	51998	U002	108.00 x	127.00 x	— x	9.50 x	—
57667	U004	105.50 x	124.00 x	— x	13.50 x	—	53351	U04A	108.00 x	127.00 x	— x	10.00 x	—
51884	U004	105.60 x	107.95 x	— x	9.52 x	—	53351	U04A	108.00 x	127.00 x	— x	10.00 x	—
57668	U007	106.00 x	116.50 x	— x	12.00 x	—	6019	CH	108.00 x	127.00 x	— x	11.91 x	—
57669	U008	106.00 x	116.50 x	— x	12.00 x	—	57690	U001	108.00 x	128.00 x	— x	18.00 x	—
57670	U001	106.00 x	118.00 x	— x	7.00 x	—	57691	U002	108.00 x	128.00 x	— x	18.00 x	—
57671	U002	106.00 x	118.00 x	— x	7.00 x	—	53315	U04A	108.00 x	128.50 x	— x	10.00 x	—
57672	U001	106.00 x	118.00 x	— x	12.00 x	—	57692	U002	108.00 x	130.00 x	— x	12.00 x	—
57673	U002	106.00 x	118.00 x	— x	12.00 x	—	—	CH	108.00 x	130.00 x	— x	48.00 x	—
57674	U005	106.00 x	119.00 x	— x	7.00 x	—	—	U04A	108.00 x	133.40 x	— x	12.70 x	—
52056	U04A	106.00 x	120.00 x	— x	10.00 x	—	—	U04A	108.00 x	133.40 x	— x	19.05 x	—
52056	U04A	106.00 x	120.00 x	— x	10.00 x	—	57693	U001	108.00 x	138.00 x	— x	15.00 x	—
57675	U031	106.00 x	121.00 x	— x	9.00 x	—	57694	U002	108.00 x	138.00 x	— x	15.00 x	—
50029	U002	106.00 x	124.00 x	— x	16.00 x	—	52402	U003	108.00 x	138.00 x	— x	17.00 x	—
—	U04A	106.00 x	125.00 x	— x	9.50 x	—	57695	U001	108.00 x	138.00 x	— x	20.00 x	—
57676	U001	106.00 x	125.00 x	— x	10.00 x	—	—	CH	108.00 x	138.00 x	— x	71.00 x	—
57677	U002	106.00 x	125.00 x	— x	10.00 x	—	F11119	W	108.00 x	140.00 x	— x	20.00 x	—
—	CH	106.00 x	125.00 x	— x	43.00 x	—	52019	U029	108.00 x	141.00 x	— x	20.00 x	—
50529	U002	106.36 x	127.00 x	— x	15.87 x	—	52019	U	108.00 x	141.00 x	— x	95.00 x	—
57678	U007	106.36 x	127.00 x	— x	30.16 x	—	57696	U001	108.00 x	142.00 x	— x	23.00 x	—
53115	U002	106.36 x	135.00 x	— x	11.00 x	—	57697	U002	108.00 x	142.00 x	— x	23.00 x	—
6078	CH	106.40 x	123.80 x	— x	15.88 x	—	57698	U001	108.00 x	152.40 x	— x	20.00 x	—
—	CH	106.40 x	136.50 x	— x	54.00 x	—	57699	U002	108.00 x	152.40 x	— x	20.00 x	—
3512	C	106.50 x	150.00 x	3.00 x	15.00 x	—	52419	U	108.50 x	117.00 x	— x	5.00 x	—
57679	U004	107.00 x	118.50 x	— x	8.50 x	—	50699	U019	108.50 x	123.50 x	— x	8.00 x	—
50644	U024	107.00 x	120.00 x	— x	14.00 x	—	53036	U002	108.50 x	130.00 x	— x	20.00 x	—
57680	U002	107.00 x	122.00 x	— x	16.00 x	—	53036	U002	108.50 x	130.00 x	— x	20.00 x	—
50361	U031	107.00 x	122.00 x	— x	16.00 x	—	50864	U006	109.00 x	124.00 x	— x	11.00 x	—
57681	U001	107.00 x	124.00 x	— x	16.00 x	—	8290	V	109.00 x	125.00 x	— x	6.30 x	—
57682	U002	107.00 x	124.00 x	— x	16.00 x	—	57700	U019	109.00 x	126.00 x	— x	8.00 x	—
57683	U004	107.00 x	124.00 x	— x	16.50 x	—	57701	U002	109.00 x	127.00 x	— x	10.00 x	—
6320	CH	107.00 x	124.00 x	— x	18.00 x	—	57703	U002	109.00 x	127.00 x	— x	11.00 x	—
51403	U002	107.00 x	127.00 x	— x	10.00 x	—	57704	U002	109.00 x	127.00 x	— x	11.00 x	—
51403	U002	107.00 x	127.00 x	— x	10.00 x	—	50833	U006	109.00 x	130.10 x	— x	12.80 x	—
52279	U031	107.00 x	127.00 x	— x	15.88 x	—	52066	U004	109.00 x	133.00 x	— x	19.00 x	—
52279	U031	107.00 x	127.00 x	— x	15.88 x	—	57705	U001	109.00 x	135.00 x	— x	12.00 x	—
57684	U002	107.00 x	127.00 x	— x	16.00 x	—	57706	U002	109.00 x	135.00 x	— x	12.00 x	—





Cód	Mod	Di x	De x	Esp. x	Ha1 x	Ha2	Cód	Mod	Di x	De x	Esp. x	Ha1 x	Ha2
6173	CH	109.00 x	142.50 x	— x	57.00 x	—	57731	U001	110.00 x	132.00 x	— x	12.00 x	—
51773	U	109.50 x	125.00 x	— x	6.30 x	—	57732	U002	110.00 x	132.00 x	— x	12.00 x	—
51773	U061	109.50 x	125.00 x	— x	6.30 x	—	6300	CH	110.00 x	132.00 x	— x	36.50 x	—
52342	U004	109.54 x	139.70 x	— x	7.10 x	—	57733	U002	110.00 x	134.00 x	— x	20.00 x	—
57707	U001	110.00 x	118.00 x	— x	6.00 x	—	51548	U003	110.00 x	135.00 x	— x	10.00 x	—
57708	U002	110.00 x	118.00 x	— x	6.00 x	—	57734	U002	110.00 x	135.00 x	— x	12.00 x	—
57709	U001	110.00 x	118.00 x	— x	12.00 x	—	51121	U006	110.00 x	135.00 x	— x	12.00 x	—
53485	U002	110.00 x	119.00 x	— x	12.70 x	—	52427	U006	110.00 x	135.00 x	— x	12.00 x	—
59287	U001	110.00 x	120.00 x	— x	5.50 x	—	57735	U019	110.00 x	135.00 x	— x	12.00 x	—
55681	U008	110.00 x	120.00 x	— x	10.00 x	—	51805	U001	110.00 x	135.00 x	— x	18.00 x	—
57710	U002	110.00 x	120.00 x	— x	12.00 x	—	57736	U002	110.00 x	135.00 x	— x	18.00 x	—
57711	U007	110.00 x	120.00 x	— x	13.50 x	—	57737	U001	110.00 x	135.00 x	— x	22.00 x	—
53009	U008	110.00 x	120.00 x	— x	13.50 x	—	57738	U002	110.00 x	135.00 x	— x	22.00 x	—
57712	U008	110.00 x	120.00 x	— x	13.50 x	—	6274	CH	110.00 x	135.00 x	— x	30.50 x	—
53032	U002	110.00 x	122.00 x	— x	10.00 x	—	—	CH	110.00 x	135.00 x	— x	60.00 x	—
51282	U002	110.00 x	122.00 x	— x	10.00 x	—	—	CH	110.00 x	135.00 x	— x	74.50 x	—
53032	U002	110.00 x	122.00 x	— x	10.00 x	—	57739	U001	110.00 x	136.00 x	— x	22.00 x	—
53032	U002	110.00 x	122.00 x	— x	10.00 x	—	57740	U002	110.00 x	136.00 x	— x	22.00 x	—
53032	U04A	110.00 x	122.00 x	— x	10.00 x	—	52993	U	110.00 x	140.00 x	— x	15.00 x	—
53032	U04A	110.00 x	122.00 x	— x	10.00 x	—	51547	U001	110.00 x	140.00 x	— x	15.00 x	—
53185	U04A	110.00 x	122.00 x	— x	10.00 x	—	57741	U002	110.00 x	140.00 x	— x	15.00 x	—
57713	U001	110.00 x	124.00 x	— x	7.00 x	—	52993	U002	110.00 x	140.00 x	— x	15.00 x	—
53944	U002	110.00 x	124.00 x	— x	7.00 x	—	57742	U019	110.00 x	140.00 x	— x	15.00 x	—
57714	U004	110.00 x	124.00 x	— x	15.00 x	—	50694	U006	110.00 x	140.00 x	— x	16.00 x	—
51875	U	110.00 x	125.00 x	— x	7.00 x	—	57743	U002	110.00 x	140.00 x	— x	18.00 x	—
57715	U002	110.00 x	125.00 x	— x	7.00 x	—	57744	U004	110.00 x	140.00 x	— x	18.00 x	—
51875	U04A	110.00 x	125.00 x	— x	7.00 x	—	6346	CH	110.00 x	140.00 x	— x	183.00 x	—
57716	U001	110.00 x	125.00 x	— x	7.50 x	—	57745	U001	110.00 x	142.00 x	— x	16.00 x	—
53411	U04A	110.00 x	125.00 x	— x	9.00 x	—	57746	U002	110.00 x	142.00 x	— x	16.00 x	—
52845	U	110.00 x	125.00 x	— x	10.00 x	—	59335	U001	110.00 x	143.00 x	— x	20.00 x	—
57717	U007	110.00 x	125.00 x	— x	10.00 x	—	57747	U001	110.00 x	145.00 x	— x	17.00 x	—
52845	U008	110.00 x	125.00 x	— x	10.00 x	—	57748	U002	110.00 x	145.00 x	— x	17.00 x	—
59433	U	110.00 x	125.00 x	— x	10.90 x	—	52103	U002	110.00 x	150.00 x	— x	20.00 x	—
59426	U04A	110.00 x	125.00 x	— x	11.00 x	—	57749	U002	110.00 x	150.00 x	— x	20.00 x	—
57718	U001	110.00 x	125.00 x	— x	12.00 x	—	57750	U001	110.00 x	150.00 x	— x	30.00 x	—
57719	U002	110.00 x	125.00 x	— x	12.00 x	—	57751	U002	110.00 x	150.00 x	— x	30.00 x	—
57720	U002	110.00 x	125.00 x	— x	15.00 x	—	3188	C	110.00 x	200.00 x	5.50 x	20.00 x	—
50975	U004	110.00 x	125.00 x	— x	15.00 x	—	57752	U001	110.00 x	200.00 x	— x	20.00 x	—
50975	U004	110.00 x	125.00 x	— x	16.00 x	—	57753	U002	110.00 x	200.00 x	— x	20.00 x	—
57721	U007	110.00 x	125.00 x	— x	16.00 x	—	51527	U	110.33 x	124.62 x	— x	8.50 x	—
57722	U008	110.00 x	125.00 x	— x	16.00 x	—	53118	U002	110.50 x	126.00 x	— x	7.50 x	—
51053	U004	110.00 x	125.00 x	— x	23.00 x	—	53118	U031	110.50 x	126.00 x	— x	7.50 x	—
6227	CH	110.00 x	125.00 x	— x	32.40 x	—	57754	U002	110.50 x	131.00 x	— x	7.00 x	—
51977	U002	110.00 x	129.00 x	— x	7.50 x	—	—	U04A	110.74 x	118.74 x	— x	10.92 x	—
50127	U004	110.00 x	129.00 x	— x	15.00 x	—	57755	U004	111.00 x	124.50 x	— x	9.00 x	—
8301	V	110.00 x	130.00 x	— x	8.00 x	—	53339	U002	111.00 x	125.00 x	— x	7.00 x	—
8241	V	110.00 x	130.00 x	— x	8.50 x	—	57756	U031	111.00 x	125.00 x	— x	7.00 x	—
51852	U002	110.00 x	130.00 x	— x	10.00 x	—	50275	U024	111.00 x	125.00 x	— x	20.00 x	—
57723	U002	110.00 x	130.00 x	— x	10.00 x	—	57757	U003	111.00 x	136.00 x	— x	21.00 x	—
57724	U004	110.00 x	130.00 x	— x	10.00 x	—	50100	U002	111.00 x	151.00 x	— x	20.00 x	—
8046	V	110.00 x	130.00 x	— x	10.50 x	—	3114	C	111.00 x	170.00 x	3.00 x	13.50 x	—
57725	U004	110.00 x	130.00 x	— x	12.00 x	—	—	U04A	111.10 x	123.80 x	— x	6.35 x	—
53358	U065	110.00 x	130.00 x	— x	12.00 x	—	—	U04A	111.10 x	127.00 x	— x	7.93 x	—
F2312	J	110.00 x	130.00 x	— x	12.70 x	15.00	—	U04A	111.10 x	130.20 x	— x	9.52 x	—
51932	U004	110.00 x	130.00 x	— x	14.50 x	—	57758	U001	111.10 x	139.70 x	— x	26.00 x	—
57726	U005	110.00 x	130.00 x	— x	14.50 x	—	59307	U	111.12 x	127.00 x	— x	14.28 x	—
57727	U006	110.00 x	130.00 x	— x	14.50 x	—	8084	V	111.12 x	141.29 x	— x	9.00 x	—
50948	U	110.00 x	130.00 x	— x	15.00 x	—	6089	CH	111.12 x	141.29 x	— x	38.10 x	—
50677	U002	110.00 x	130.00 x	— x	15.00 x	—	57759	U019	111.13 x	127.00 x	— x	7.94 x	—
57728	U002	110.00 x	130.00 x	— x	15.00 x	—	57760	U019	111.13 x	130.18 x	— x	9.53 x	—
50948	U031	110.00 x	130.00 x	— x	15.00 x	—	57761	U002	111.13 x	139.70 x	— x	26.19 x	—
50948	U031	110.00 x	130.00 x	— x	15.00 x	—	50714	U006	111.30 x	124.00 x	— x	9.52 x	—
57729	U001	110.00 x	130.00 x	— x	18.00 x	—	—	CH	111.50 x	128.00 x	— x	25.50 x	—
57730	U002	110.00 x	130.00 x	— x	19.00 x	—	51367	U	111.72 x	127.00 x	— x	7.94 x	—
6278	CH	110.00 x	130.00 x	— x	42.50 x	—	53328	U	111.72 x	127.00 x	— x	14.20 x	—
—	CH	110.00 x	130.00 x	— x	58.00 x	—	51371	U	111.90 x	125.04 x	— x	8.00 x	—
—	CH	110.00 x	131.00 x	— x	39.00 x	—	53528	UL	112.00 x	122.00 x	— x	6.35 x	8.73



Cód	Mod	Di x	De x	Esp. x	Ha1 x	Ha2	Cód	Mod	Di x	De x	Esp. x	Ha1 x	Ha2
53526	U004	112.00 x	123.50 x	— x	8.73 x	—	51668	U045	114.30 x	127.00 x	— x	15.87 x	—
57762	U001	112.00 x	124.00 x	— x	12.00 x	—	—	CH	114.30 x	127.00 x	— x	25.00 x	—
57763	U002	112.00 x	124.00 x	— x	12.00 x	—	—	U04A	114.30 x	130.20 x	— x	15.87 x	—
53074	U	112.00 x	125.00 x	— x	6.00 x	—	57790	U002	114.30 x	133.35 x	— x	6.35 x	—
52537	U001	112.00 x	125.00 x	— x	7.00 x	—	57791	U019	114.30 x	133.35 x	— x	9.53 x	—
57764	U004	112.00 x	125.00 x	— x	8.50 x	—	52771	U002	114.30 x	133.35 x	— x	15.87 x	—
57765	U007	112.00 x	125.00 x	— x	9.00 x	—	6327	CH	114.30 x	133.35 x	— x	30.00 x	—
52864	U	112.00 x	126.00 x	— x	7.00 x	—	—	CH	114.30 x	133.35 x	— x	55.00 x	—
52183	U	112.00 x	126.00 x	— x	10.00 x	6.50	—	CH	114.30 x	134.35 x	— x	55.00 x	—
55757	U	112.00 x	127.00 x	— x	10.00 x	—	6242	CH	114.30 x	134.90 x	— x	22.22 x	—
—	CH	112.00 x	128.00 x	— x	28.00 x	—	—	CH	114.30 x	134.94 x	— x	43.00 x	—
57766	U001	112.00 x	130.00 x	— x	9.00 x	—	8208	V	114.30 x	136.50 x	— x	10.00 x	—
57767	U002	112.00 x	130.00 x	— x	9.00 x	—	57792	U019	114.30 x	136.53 x	— x	9.53 x	—
57768	U001	112.00 x	130.00 x	— x	20.00 x	—	57793	U031	114.30 x	136.53 x	— x	15.08 x	—
57769	U001	112.00 x	136.00 x	— x	12.00 x	—	8311	V	114.30 x	138.13 x	— x	12.70 x	—
57770	U002	112.00 x	136.00 x	— x	12.00 x	—	8212	V	114.30 x	139.70 x	— x	9.52 x	—
—	CH	112.00 x	140.00 x	— x	61.00 x	—	8092	V	114.30 x	139.70 x	— x	9.52 x	—
57771	U001	112.00 x	142.00 x	— x	15.00 x	—	8214	V	114.30 x	139.70 x	— x	10.32 x	—
57772	U002	112.00 x	142.00 x	— x	15.00 x	—	8215	V	114.30 x	139.70 x	— x	10.32 x	—
57773	U001	112.00 x	144.00 x	— x	15.00 x	—	8213	V	114.30 x	139.70 x	— x	11.51 x	—
57774	U002	112.00 x	144.00 x	— x	15.00 x	—	—	U04A	114.30 x	139.70 x	— x	12.70 x	—
59428	U002	112.50 x	125.50 x	— x	7.00 x	—	—	U04A	114.30 x	139.70 x	— x	19.05 x	—
52193	U031	112.70 x	127.00 x	— x	7.14 x	—	6015	CH	114.30 x	139.70 x	— x	39.69 x	—
52193	U031	112.70 x	127.00 x	— x	7.14 x	—	6056	CH	114.30 x	139.70 x	— x	42.00 x	—
52228	U056	112.80 x	155.00 x	— x	27.00 x	—	52433	U	114.30 x	140.00 x	— x	12.50 x	—
51173	U001	113.00 x	124.00 x	— x	6.40 x	—	50792	U002	114.30 x	142.87 x	— x	11.91 x	—
57775	U004	113.00 x	125.00 x	— x	10.50 x	—	—	U04A	114.30 x	146.10 x	— x	15.87 x	—
57776	U019	113.00 x	125.00 x	— x	13.00 x	—	3093	C	114.30 x	152.40 x	9.00 x	14.29 x	—
51461	U002	113.00 x	127.00 x	— x	7.50 x	—	57794	U002	114.50 x	126.50 x	— x	11.00 x	—
51201	U	113.00 x	127.00 x	— x	10.00 x	9.00	52980	U04A	114.50 x	127.00 x	— x	8.00 x	—
51546	U031	113.00 x	128.00 x	— x	7.00 x	—	57795	U019	114.50 x	127.00 x	— x	20.00 x	—
52825	U079	113.00 x	138.00 x	— x	9.50 x	8.00	55652	U04A	114.50 x	130.00 x	— x	6.30 x	—
51780	U031	113.50 x	126.20 x	— x	7.00 x	—	57796	U005	115.00 x	123.00 x	— x	12.00 x	—
—	CH	113.50 x	138.00 x	— x	43.00 x	—	57797	U006	115.00 x	123.00 x	— x	12.00 x	—
57777	U002	113.80 x	125.20 x	— x	7.50 x	—	57799	U002	115.00 x	124.00 x	— x	14.00 x	—
57778	U001	114.00 x	124.00 x	— x	10.00 x	—	57798	U005	115.00 x	124.00 x	— x	14.00 x	—
57779	U002	114.00 x	124.00 x	— x	10.00 x	—	53033	U005	115.00 x	125.00 x	— x	9.00 x	—
50733	U002	114.00 x	125.00 x	— x	6.35 x	—	57800	U019	115.00 x	125.00 x	— x	9.00 x	—
57780	U004	114.00 x	125.00 x	— x	9.50 x	—	53033	U056	115.00 x	125.00 x	— x	9.00 x	—
57781	U004	114.00 x	126.00 x	— x	8.50 x	—	57801	U005	115.00 x	125.00 x	— x	11.80 x	—
57782	U001	114.00 x	126.00 x	— x	13.00 x	—	57802	U006	115.00 x	125.00 x	— x	11.80 x	—
59409	UL	114.00 x	127.00 x	— x	7.00 x	9.00	50157	U024	115.00 x	125.00 x	— x	13.00 x	—
52217	U003	114.00 x	127.00 x	— x	9.50 x	—	57803	U007	115.00 x	125.00 x	— x	14.00 x	—
51188	U003	114.00 x	127.00 x	— x	10.50 x	—	57804	U008	115.00 x	125.00 x	— x	14.00 x	—
51636	U031	114.00 x	127.00 x	— x	115.00 x	—	57805	U002	115.00 x	126.00 x	— x	8.00 x	—
51404	U	114.00 x	137.00 x	— x	15.60 x	—	50047	U031	115.00 x	126.00 x	— x	8.00 x	—
50759	U002	114.00 x	139.00 x	— x	28.00 x	—	57806	U001	115.00 x	126.00 x	— x	15.00 x	—
—	CH	114.00 x	140.00 x	— x	48.00 x	—	57807	U002	115.00 x	126.00 x	— x	15.00 x	—
—	CH	114.00 x	140.00 x	— x	61.00 x	—	57808	U004	115.00 x	126.00 x	— x	15.00 x	—
6130	CH	114.00 x	141.00 x	— x	39.00 x	—	51444	U	115.00 x	127.00 x	— x	6.50 x	—
57783	U001	114.00 x	145.00 x	— x	12.00 x	—	52638	U031	115.00 x	127.00 x	— x	8.00 x	—
57784	U002	114.00 x	145.00 x	— x	12.00 x	—	53311	U006	115.00 x	127.00 x	— x	8.50 x	—
57785	U005	114.30 x	122.20 x	— x	13.50 x	—	52370	U003	115.00 x	127.00 x	— x	9.50 x	—
57786	U006	114.30 x	122.24 x	— x	13.49 x	—	57809	U002	115.00 x	128.00 x	— x	6.50 x	—
53396	U04A	114.30 x	125.40 x	— x	6.35 x	—	57810	U003	115.00 x	128.00 x	— x	14.00 x	—
57787	U002	114.30 x	125.41 x	— x	6.35 x	—	51132	U	115.00 x	130.00 x	— x	7.50 x	5.50
51221	U036	114.30 x	127.00 x	— x	6.30 x	—	53402	U04A	115.00 x	130.00 x	— x	8.00 x	—
52977	U002	114.30 x	127.00 x	— x	6.35 x	—	52878	U	115.00 x	130.00 x	— x	12.50 x	11.40
51221	U036	114.30 x	127.00 x	— x	6.35 x	—	57811	U005	115.00 x	130.00 x	— x	13.00 x	—
52977	U04A	114.30 x	127.00 x	— x	6.35 x	—	57812	U006	115.00 x	130.00 x	— x	13.00 x	—
53331	U003	114.30 x	127.00 x	— x	7.50 x	—	50095	U026	115.00 x	130.00 x	— x	14.00 x	—
52260	U002	114.30 x	127.00 x	— x	8.33 x	—	50095	U026	115.00 x	130.00 x	— x	14.00 x	—
50812	U001	114.30 x	127.00 x	— x	9.52 x	—	57813	U004	115.00 x	130.00 x	— x	15.00 x	—
53383	U04A	114.30 x	127.00 x	— x	9.52 x	—	—	CH	115.00 x	130.00 x	— x	34.00 x	—
50883	U	114.30 x	127.00 x	— x	10.00 x	—	51839	U002	115.00 x	134.00 x	— x	9.50 x	—
50883	U008	114.30 x	127.00 x	— x	10.32 x	—	57814	U001	115.00 x	134.00 x	— x	10.00 x	—
52337	U	114.30 x	127.00 x	— x	14.20 x	—	57815	U002	115.00 x	134.00 x	— x	10.00 x	—



Cód	Mod	Di x	De x	Esp. x	Ha1 x	Ha2	Cód	Mod	Di x	De x	Esp. x	Ha1 x	Ha2
57816	U004	115.00 x	135.00 x	— x	15.00 x	—	57845	U001	118.00 x	150.00 x	— x	15.00 x	—
3193	C	115.00 x	138.00 x	6.00 x	18.00 x	—	57846	U002	118.00 x	150.00 x	— x	15.00 x	—
6375	CH	115.00 x	139.50 x	— x	— x	—	3237	C	118.00 x	150.00 x	3.00 x	16.00 x	—
57817	U001	115.00 x	140.00 x	— x	12.00 x	—	51682	U006	118.00 x	152.00 x	— x	16.00 x	—
57818	U002	115.00 x	140.00 x	— x	12.00 x	—	3319	C	118.00 x	154.00 x	4.00 x	16.00 x	—
51877	U04A	115.00 x	140.00 x	— x	13.50 x	—	57847	U001	118.00 x	154.00 x	— x	30.00 x	—
55639	U001	115.00 x	140.00 x	— x	15.00 x	—	57848	U002	118.00 x	154.00 x	— x	30.00 x	—
57819	U004	115.00 x	140.00 x	— x	18.00 x	—	53291	U006	118.50 x	131.20 x	— x	12.50 x	—
52767	U	115.00 x	140.00 x	— x	20.00 x	—	53087	U04A	119.00 x	127.00 x	— x	10.00 x	—
52762	U	115.00 x	140.00 x	— x	20.00 x	—	50134	U024	119.00 x	127.00 x	— x	14.50 x	—
F7088	J	115.00 x	140.00 x	— x	21.00 x	—	8280	V	119.00 x	131.00 x	— x	4.50 x	—
57820	U001	115.00 x	140.00 x	— x	22.00 x	—	50026	U091	119.00 x	133.00 x	— x	7.00 x	—
57821	U002	115.00 x	140.00 x	— x	22.00 x	—	57849	U005	119.00 x	136.00 x	— x	8.50 x	—
6179	CH	115.00 x	140.00 x	— x	32.00 x	—	57850	U006	119.00 x	136.00 x	— x	8.50 x	—
8065	V	115.00 x	141.50 x	— x	8.00 x	—	57851	U004	119.00 x	138.50 x	— x	15.00 x	—
—	CH	115.00 x	144.50 x	— x	75.00 x	—	57852	U002	119.00 x	162.00 x	— x	16.00 x	—
57822	U002	115.00 x	145.00 x	— x	12.00 x	—	57853	U005	119.06 x	131.76 x	— x	7.94 x	—
57823	U019	115.00 x	145.00 x	— x	12.00 x	—	53330	U031	120.00 x	130.00 x	— x	12.00 x	—
52330	U	115.00 x	145.00 x	— x	12.50 x	—	57854	U003	120.00 x	130.00 x	— x	13.00 x	—
57824	U004	115.00 x	145.00 x	— x	18.00 x	—	57855	U005	120.00 x	130.00 x	— x	13.50 x	—
57825	U001	115.00 x	150.00 x	— x	17.00 x	—	57856	U006	120.00 x	130.00 x	— x	13.50 x	—
57826	U002	115.00 x	150.00 x	— x	17.00 x	—	57857	U007	120.00 x	130.00 x	— x	13.50 x	—
57827	U001	115.00 x	155.00 x	— x	20.00 x	—	57858	U008	120.00 x	130.00 x	— x	13.50 x	—
57828	U002	115.00 x	155.00 x	— x	20.00 x	—	57859	U007	120.00 x	130.00 x	— x	14.00 x	—
57829	U007	115.50 x	127.00 x	— x	6.50 x	—	52275	U006	120.00 x	130.00 x	— x	18.00 x	—
50459	U004	115.98 x	139.70 x	— x	17.46 x	—	57860	U006	120.00 x	130.00 x	— x	18.00 x	—
51322	U026	115.98 x	155.00 x	— x	27.00 x	—	57861	U001	120.00 x	132.00 x	— x	12.00 x	—
57830	U019	116.00 x	125.00 x	— x	9.00 x	—	57862	U002	120.00 x	132.00 x	— x	12.00 x	—
55669	U031	116.00 x	127.00 x	6.35 x	— x	—	51299	U	120.00 x	135.00 x	— x	7.50 x	—
52175	U04A	116.00 x	127.00 x	— x	6.35 x	—	57863	U005	120.00 x	135.00 x	— x	7.50 x	—
57831	U001	116.00 x	128.00 x	— x	8.00 x	—	57864	U006	120.00 x	135.00 x	— x	10.00 x	—
57832	U002	116.00 x	128.00 x	— x	8.00 x	—	52784	U004	120.00 x	135.00 x	— x	15.00 x	—
8320	V	116.00 x	139.00 x	— x	9.50 x	—	57865	U001	120.00 x	137.00 x	— x	8.00 x	—
51705	U003	116.00 x	139.00 x	— x	20.00 x	—	57866	U002	120.00 x	137.00 x	— x	8.00 x	—
—	CH	116.00 x	139.00 x	— x	85.00 x	—	55759	U	120.00 x	138.00 x	— x	10.00 x	—
52236	U	116.50 x	123.00 x	— x	8.00 x	—	51789	U008	120.00 x	139.00 x	— x	10.00 x	8.50
8309	V	117.00 x	133.10 x	— x	7.50 x	—	50695	U	120.00 x	139.00 x	— x	16.00 x	—
6304	CH	117.00 x	139.30 x	— x	6.00 x	—	52007	U002	120.00 x	140.00 x	— x	8.50 x	—
F14216	ESPE	117.30 x	128.50 x	— x	2.50 x	0.50	57867	U002	120.00 x	140.00 x	— x	10.00 x	—
3082	C	117.47 x	149.22 x	4.00 x	17.46 x	—	57868	U019	120.00 x	140.00 x	— x	10.00 x	—
3177	C	117.47 x	152.40 x	4.00 x	20.64 x	—	8049	V	120.00 x	140.00 x	— x	10.50 x	—
3177	C	117.47 x	152.40 x	4.00 x	20.64 x	—	52759	U003	120.00 x	140.00 x	— x	12.50 x	10.00
52062	U024	117.48 x	125.41 x	— x	12.70 x	—	57869	U002	120.00 x	140.00 x	— x	15.00 x	—
57833	U004	117.48 x	130.18 x	— x	12.70 x	—	50977	U004	120.00 x	140.00 x	— x	15.00 x	—
57834	U002	117.48 x	130.18 x	— x	14.29 x	—	57870	U004	120.00 x	140.00 x	— x	15.00 x	—
—	CH	117.48 x	133.35 x	— x	49.00 x	—	50977	U004	120.00 x	140.00 x	— x	15.00 x	—
57835	U031	117.48 x	138.11 x	— x	14.68 x	—	50964	U007	120.00 x	140.00 x	— x	16.00 x	—
57836	U019	117.48 x	139.70 x	— x	9.53 x	—	50964	U007	120.00 x	140.00 x	— x	16.00 x	—
—	U04A	117.50 x	123.80 x	— x	14.28 x	—	57872	U002	120.00 x	140.00 x	— x	17.50 x	—
—	U04A	117.50 x	130.20 x	— x	14.28 x	—	57873	U001	120.00 x	140.00 x	— x	18.00 x	—
—	U04A	117.50 x	136.50 x	— x	9.52 x	—	57874	U008	120.00 x	140.00 x	— x	20.00 x	—
—	CH	117.50 x	137.00 x	— x	39.00 x	—	6139	CH	120.00 x	140.00 x	— x	35.00 x	—
51830	U017	118.00 x	124.00 x	— x	4.50 x	—	57875	U001	120.00 x	142.00 x	— x	18.00 x	—
57837	U001	118.00 x	126.00 x	— x	8.00 x	—	57876	U002	120.00 x	142.00 x	— x	18.00 x	—
57838	U002	118.00 x	126.00 x	— x	8.00 x	—	—	CH	120.00 x	142.00 x	— x	33.00 x	—
57839	U005	118.00 x	126.00 x	— x	12.00 x	—	8076	V	120.00 x	145.00 x	— x	12.70 x	—
57840	U006	118.00 x	126.00 x	— x	12.00 x	—	8021	V	120.00 x	145.00 x	— x	14.00 x	—
57841	U019	118.00 x	126.00 x	— x	13.00 x	—	57877	U002	120.00 x	145.00 x	— x	15.00 x	—
57842	U007	118.00 x	128.00 x	— x	15.00 x	—	51961	U	120.00 x	145.00 x	— x	16.00 x	10.00
57843	U008	118.00 x	128.00 x	— x	15.00 x	—	53128	U002	120.00 x	145.00 x	— x	18.00 x	—
50624	U024	118.00 x	129.00 x	— x	15.00 x	—	57878	U004	120.00 x	145.00 x	— x	18.00 x	—
52332	U	118.00 x	130.00 x	— x	6.00 x	—	6059	CH	120.00 x	145.00 x	— x	42.50 x	—
59241	U001	118.00 x	130.00 x	— x	6.00 x	—	8216	V	120.00 x	146.00 x	— x	10.00 x	—
57844	U002	118.00 x	130.00 x	— x	6.00 x	—	50580	U002	120.00 x	146.00 x	— x	12.00 x	—
52271	U019	118.00 x	139.00 x	— x	5.70 x	—	8409	V	120.00 x	149.00 x	— x	14.00 x	—
6265	CH	118.00 x	145.00 x	— x	33.50 x	—	—	CH	120.00 x	149.00 x	— x	62.00 x	—
53481	U04A	118.00 x	148.00 x	— x	20.00 x	—	57879	U001	120.00 x	150.00 x	— x	15.00 x	—



Cód	Mod	Di x	De x	Esp. x	Ha1 x	Ha2	Cód	Mod	Di x	De x	Esp. x	Ha1 x	Ha2
50514	U002	120.00 x	150.00 x	— x	15.00 x	—	57906	U008	125.00 x	136.00 x	— x	13.50 x	—
57880	U019	120.00 x	150.00 x	— x	15.00 x	—	59454	UL	125.00 x	138.00 x	— x	7.00 x	10.00
50986	U	120.00 x	150.00 x	— x	18.00 x	—	52697	U	125.00 x	139.70 x	— x	12.00 x	—
57881	U002	120.00 x	150.00 x	— x	18.00 x	—	52697	U002	125.00 x	139.70 x	— x	12.00 x	—
—	U04A	120.00 x	150.00 x	— x	22.50 x	—	52341	U	125.00 x	140.00 x	— x	9.00 x	—
57882	U001	120.00 x	150.00 x	— x	26.00 x	—	51938	U	125.00 x	140.00 x	— x	10.00 x	—
57883	U002	120.00 x	150.00 x	— x	26.00 x	—	57907	U007	125.00 x	140.00 x	— x	10.00 x	—
6309	CH	120.00 x	150.00 x	— x	28.00 x	—	8351	V	125.00 x	140.00 x	— x	10.00 x	—
57884	U002	120.00 x	150.00 x	— x	30.00 x	—	57908	U001	125.00 x	140.00 x	— x	15.00 x	—
3292	C	120.00 x	160.00 x	5.00 x	20.00 x	—	57909	U004	125.00 x	140.00 x	— x	15.00 x	—
57885	U002	120.00 x	160.00 x	— x	20.00 x	—	52830	U04A	125.00 x	140.00 x	— x	15.00 x	—
57886	U008	120.00 x	170.00 x	— x	20.00 x	—	52830	U04A	125.00 x	140.00 x	— x	15.00 x	—
59368	UL	120.20 x	133.00 x	— x	7.00 x	11.50	6251	CH	125.00 x	140.00 x	— x	31.00 x	—
50147	U027	120.35 x	134.95 x	— x	7.00 x	—	6218	CH	125.00 x	140.00 x	— x	33.00 x	—
3402	C	120.60 x	184.15 x	4.00 x	33.40 x	—	50493	U002	125.00 x	145.00 x	— x	10.00 x	—
52322	U004	120.65 x	127.00 x	— x	3.20 x	—	57910	U002	125.00 x	145.00 x	— x	10.00 x	—
50645	U004	120.65 x	133.35 x	— x	7.94 x	—	50493	U002	125.00 x	145.00 x	— x	10.00 x	—
—	CH	120.65 x	134.94 x	— x	35.00 x	—	50493	U019	125.00 x	145.00 x	— x	10.00 x	—
57887	U019	120.65 x	139.70 x	— x	9.53 x	—	8237	V	125.00 x	145.00 x	— x	10.00 x	—
51178	U004	120.65 x	139.70 x	— x	15.87 x	—	57911	U004	125.00 x	145.00 x	— x	12.00 x	—
—	CH	120.65 x	146.05 x	— x	38.00 x	—	51791	U004	125.00 x	145.00 x	— x	12.00 x	—
—	CH	120.65 x	146.05 x	— x	47.00 x	—	55662	U004	125.00 x	145.00 x	— x	15.00 x	—
6160	CH	120.65 x	149.22 x	— x	85.72 x	—	57912	U001	125.00 x	145.00 x	— x	18.00 x	—
3533	C	120.65 x	152.40 x	— x	19.05 x	—	57913	U002	125.00 x	145.00 x	— x	18.00 x	—
53018	U002	120.70 x	133.40 x	— x	6.35 x	—	—	CH	125.00 x	145.00 x	— x	42.00 x	—
53018	U04A	120.70 x	133.40 x	— x	6.35 x	—	53434	U04A	125.00 x	149.00 x	— x	15.00 x	—
51178	U04A	120.70 x	139.70 x	— x	15.87 x	—	57914	U001	125.00 x	150.00 x	— x	12.00 x	—
—	U04A	120.70 x	158.80 x	— x	25.40 x	—	57915	U002	125.00 x	150.00 x	— x	12.00 x	—
52490	U029	120.80 x	162.00 x	— x	16.00 x	—	57916	U008	125.00 x	150.00 x	— x	15.00 x	—
52495	U029	120.80 x	162.00 x	— x	16.00 x	—	51654	U002	125.00 x	150.00 x	— x	16.50 x	15.50
52490	U029	120.80 x	162.00 x	— x	16.00 x	—	51965	U004	125.00 x	150.00 x	— x	18.00 x	—
57888	U001	121.00 x	141.00 x	— x	12.00 x	—	51965	U04A	125.00 x	150.00 x	— x	18.00 x	—
3163	C	121.00 x	152.50 x	— x	19.50 x	—	3358	C	125.00 x	150.00 x	— x	18.50 x	—
57889	U031	121.00 x	174.00 x	— x	15.00 x	—	6289	CH	125.00 x	150.00 x	— x	42.50 x	—
53244	U002	121.40 x	138.40 x	— x	9.80 x	—	6131	CH	125.00 x	150.00 x	— x	42.50 x	—
57890	U007	122.00 x	135.00 x	— x	9.50 x	—	57917	U001	125.00 x	154.00 x	— x	20.00 x	—
57891	U001	122.00 x	142.00 x	— x	10.00 x	—	57918	U002	125.00 x	154.00 x	— x	20.00 x	—
57892	U002	122.00 x	142.00 x	— x	10.00 x	—	57919	U001	125.00 x	155.00 x	— x	15.00 x	—
57893	U002	122.00 x	142.00 x	— x	13.00 x	—	57920	U002	125.00 x	155.00 x	— x	15.00 x	—
57894	U002	122.00 x	152.00 x	— x	15.00 x	—	57921	U019	125.00 x	155.00 x	— x	15.00 x	—
3315	C	122.50 x	152.00 x	— x	13.50 x	—	52894	U004	125.00 x	155.00 x	— x	18.00 x	—
51928	U001	123.00 x	135.00 x	— x	8.00 x	—	52894	U004	125.00 x	155.00 x	— x	18.00 x	—
53310	U004	123.00 x	135.00 x	— x	8.00 x	—	57922	U004	125.00 x	155.00 x	— x	18.00 x	—
52639	U031	123.00 x	135.00 x	— x	8.00 x	—	57923	U001	125.00 x	155.00 x	— x	26.00 x	—
57895	U002	123.00 x	138.00 x	— x	8.00 x	—	57924	U002	125.00 x	155.00 x	— x	26.00 x	—
—	CH	123.00 x	155.00 x	— x	73.00 x	—	6465	CH	125.00 x	155.00 x	— x	28.00 x	—
53298	U	123.50 x	140.00 x	— x	7.00 x	—	6422	CH	125.00 x	155.00 x	— x	53.50 x	—
53298	UL	123.50 x	140.00 x	— x	7.00 x	9.50	57925	U001	125.00 x	156.00 x	— x	15.00 x	—
6364	CH	123.80 x	139.70 x	— x	35.00 x	—	57926	U001	125.00 x	157.00 x	— x	23.00 x	—
57871	U04A	123.80 x	142.90 x	— x	15.87 x	—	57927	U002	125.00 x	157.00 x	— x	23.00 x	—
52702	U005	123.80 x	149.50 x	— x	13.50 x	—	57928	U001	125.00 x	160.00 x	— x	15.00 x	—
57896	U019	123.83 x	142.88 x	— x	9.53 x	—	57929	U002	125.00 x	160.00 x	— x	15.00 x	—
51534	U	123.90 x	150.06 x	— x	18.50 x	—	—	CH	125.00 x	160.00 x	— x	41.00 x	—
51283	U002	124.00 x	135.00 x	— x	12.00 x	—	57930	U001	125.00 x	165.00 x	— x	20.00 x	—
57897	U004	124.00 x	138.00 x	— x	14.00 x	—	57931	U002	125.00 x	165.00 x	— x	20.00 x	—
57898	U004	124.00 x	153.00 x	— x	19.00 x	—	57932	U003	125.00 x	165.00 x	— x	20.00 x	—
57899	U001	124.00 x	162.00 x	— x	20.00 x	—	F5846	J	125.40 x	152.40 x	— x	16.00 x	22.00
57900	U001	124.00 x	180.00 x	— x	20.00 x	—	59440	UL	125.50 x	139.00 x	— x	7.10 x	10.70
50832	U007	124.70 x	149.80 x	— x	13.50 x	—	—	CH	125.50 x	149.50 x	— x	56.00 x	—
53053	U	124.90 x	159.70 x	— x	16.00 x	—	51412	U003	125.70 x	150.00 x	— x	12.00 x	—
53053	U029	124.90 x	159.70 x	— x	16.00 x	—	51412	U	125.70 x	150.00 x	— x	12.70 x	—
53053	U062	124.90 x	159.70 x	— x	16.00 x	—	52418	U	125.90 x	140.50 x	— x	8.80 x	—
57901	U004	125.00 x	135.00 x	— x	12.00 x	—	51117	U002	126.00 x	137.00 x	— x	9.00 x	8.00
57902	U005	125.00 x	135.00 x	— x	13.50 x	—	59410	UL	126.00 x	139.00 x	— x	7.00 x	9.00
57903	U007	125.00 x	135.00 x	— x	13.50 x	—	57933	U004	126.00 x	140.00 x	— x	7.00 x	—
57904	U008	125.00 x	135.00 x	— x	13.50 x	—	59371	UL	126.00 x	140.00 x	— x	7.00 x	10.50
57905	U006	125.00 x	135.00 x	— x	14.00 x	—	—	CH	126.00 x	140.00 x	— x	31.00 x	—





Cód	Mod	Di x	De x	Esp. x	Ha1 x	Ha2	Cód	Mod	Di x	De x	Esp. x	Ha1 x	Ha2
57934	U007	126.00 x	140.50 x	— x	9.50 x	—	57950	U001	127.00 x	160.00 x	— x	15.00 x	—
57935	U002	126.00 x	142.00 x	— x	12.00 x	—	57951	U002	127.00 x	160.00 x	— x	15.00 x	—
57936	U005	126.00 x	146.00 x	— x	15.00 x	—	51772	U	127.00 x	161.00 x	— x	15.00 x	—
57937	U006	126.00 x	146.00 x	— x	15.00 x	—	57952	U003	127.00 x	162.00 x	— x	13.50 x	—
53239	U004	126.00 x	148.00 x	— x	18.00 x	—	—	U04A	127.00 x	165.10 x	— x	19.05 x	—
53262	U004	126.00 x	148.00 x	— x	18.00 x	—	52382	U04A	127.30 x	141.00 x	— x	8.80 x	—
52366	U006	126.00 x	149.00 x	— x	14.70 x	—	57953	U005	128.00 x	137.00 x	— x	15.00 x	—
51788	U090	126.00 x	150.00 x	— x	10.50 x	—	57954	U006	128.00 x	137.00 x	— x	15.00 x	—
57938	U001	126.00 x	150.00 x	— x	12.00 x	—	3338	C	128.00 x	139.00 x	— x	5.20 x	—
57939	U002	126.00 x	150.00 x	— x	12.00 x	—	57955	U001	128.00 x	140.00 x	— x	12.00 x	—
51290	U019	126.00 x	150.00 x	— x	12.00 x	—	57956	U002	128.00 x	140.00 x	— x	12.00 x	—
50312	U031	126.00 x	150.00 x	— x	12.50 x	—	57957	U006	128.00 x	140.00 x	— x	15.50 x	—
52224	U047	126.50 x	166.00 x	— x	29.00 x	24.30	57958	U007	128.00 x	140.00 x	— x	15.50 x	—
52258	U001	126.90 x	141.00 x	— x	8.00 x	—	57959	U008	128.00 x	140.00 x	— x	15.50 x	—
57940	U	127.00 x	139.00 x	— x	8.50 x	10.80	52030	U002	128.00 x	147.00 x	— x	14.00 x	—
50099	U084	127.00 x	139.00 x	— x	10.80 x	8.50	57960	U002	128.00 x	151.50 x	— x	20.50 x	—
52238	U004	127.00 x	139.20 x	— x	14.40 x	—	52937	U04A	128.00 x	153.00 x	— x	12.70 x	—
52238	U004	127.00 x	139.20 x	— x	14.40 x	—	52937	U04A	128.00 x	153.00 x	— x	12.70 x	—
—	U04A	127.00 x	139.70 x	— x	6.35 x	—	F6255	W	128.00 x	155.00 x	— x	19.00 x	—
50702	U005	127.00 x	139.70 x	— x	7.00 x	—	57961	U001	128.00 x	160.00 x	— x	15.00 x	—
59355	UL	127.00 x	139.70 x	— x	7.00 x	9.50	57962	U002	128.00 x	160.00 x	— x	15.00 x	—
6426	CH	127.00 x	139.70 x	— x	26.00 x	—	51470	U019	128.00 x	160.00 x	— x	18.00 x	—
53432	U04A	127.00 x	140.00 x	— x	12.00 x	—	57963	U001	128.00 x	168.00 x	— x	20.00 x	—
52721	U	127.00 x	141.28 x	— x	11.11 x	—	57964	U002	128.00 x	168.00 x	— x	20.00 x	—
52721	U002	127.00 x	141.28 x	— x	11.11 x	—	57965	U002	128.00 x	170.50 x	— x	19.00 x	—
50750	U	127.00 x	141.29 x	— x	7.94 x	—	53380	U001	128.10 x	140.20 x	— x	7.94 x	—
50750	U	127.00 x	141.29 x	— x	7.94 x	—	57966	U001	128.20 x	152.40 x	— x	20.00 x	—
52945	U	127.00 x	142.80 x	— x	15.80 x	—	57967	U002	128.20 x	152.40 x	— x	20.00 x	—
57941	U019	127.00 x	142.88 x	— x	7.94 x	—	57968	U019	129.00 x	150.00 x	— x	14.00 x	—
52145	U	127.00 x	143.00 x	— x	7.50 x	—	6145	CH	129.00 x	153.70 x	— x	28.50 x	—
—	U001	127.00 x	145.00 x	— x	12.00 x	—	—	CH	129.00 x	154.00 x	— x	69.00 x	—
57942	U002	127.00 x	145.00 x	— x	13.00 x	—	F6110	J	129.00 x	155.00 x	— x	16.00 x	21.50
57943	U004	127.00 x	146.00 x	— x	9.50 x	—	57969	U003	129.00 x	160.00 x	— x	15.00 x	—
59231	U04A	127.00 x	146.00 x	— x	14.00 x	—	51350	U026	129.00 x	175.00 x	— x	27.00 x	—
59231	U04A	127.00 x	146.00 x	— x	14.00 x	—	—	CH	129.38 x	145.26 x	— x	33.00 x	—
59232	U04A	127.00 x	146.00 x	— x	16.00 x	—	57970	U001	129.50 x	149.50 x	— x	10.00 x	—
55750	U04A	127.00 x	146.00 x	— x	16.00 x	—	54091	U003	130.00 x	140.00 x	— x	13.50 x	—
59232	U04A	127.00 x	146.00 x	— x	16.00 x	—	54092	U006	130.00 x	140.00 x	— x	13.50 x	—
51086	U	127.00 x	146.05 x	— x	9.52 x	—	54093	U007	130.00 x	142.00 x	— x	12.00 x	—
51085	U04A	127.00 x	146.05 x	— x	9.52 x	—	54094	U008	130.00 x	142.00 x	— x	12.00 x	—
51085	U04A	127.00 x	146.05 x	— x	9.52 x	—	53236	U004	130.00 x	145.00 x	— x	9.00 x	—
57944	U019	127.00 x	146.05 x	— x	9.53 x	—	54095	U005	130.00 x	145.00 x	— x	10.00 x	—
—	CH	127.00 x	146.05 x	— x	40.00 x	—	6258	CH	130.00 x	145.00 x	— x	34.00 x	—
51821	U	127.00 x	146.10 x	— x	9.50 x	—	54096	U004	130.00 x	147.00 x	— x	10.00 x	—
51821	U002	127.00 x	146.10 x	— x	9.52 x	—	50972	U003	130.00 x	150.00 x	— x	8.00 x	—
51821	U002	127.00 x	146.10 x	— x	9.52 x	—	51792	U002	130.00 x	150.00 x	— x	10.00 x	—
—	CH	127.00 x	147.00 x	— x	38.00 x	—	54097	U002	130.00 x	150.00 x	— x	10.00 x	—
52945	UA-2	127.00 x	148.80 x	— x	15.80 x	—	8337	V	130.00 x	150.00 x	— x	10.00 x	—
—	CH	127.00 x	149.23 x	— x	43.00 x	—	52270	U	130.00 x	150.00 x	— x	12.00 x	—
57945	U003	127.00 x	150.00 x	— x	18.00 x	—	52270	U	130.00 x	150.00 x	— x	12.00 x	—
57946	U004	127.00 x	151.50 x	— x	19.50 x	—	51863	U003	130.00 x	150.00 x	— x	12.00 x	—
51125	U	127.00 x	152.00 x	— x	12.50 x	—	54098	U003	130.00 x	150.00 x	— x	12.00 x	—
52465	U	127.00 x	152.00 x	— x	15.08 x	—	8393	V	130.00 x	150.00 x	— x	12.00 x	—
57947	U002	127.00 x	152.00 x	— x	27.00 x	—	50860	U	130.00 x	150.00 x	— x	15.00 x	—
—	CH	127.00 x	152.00 x	— x	45.00 x	—	52295	U004	130.00 x	150.00 x	— x	15.00 x	—
52123	U	127.00 x	152.40 x	— x	12.70 x	—	50643	U046	130.00 x	150.00 x	— x	15.00 x	—
52123	U002	127.00 x	152.40 x	— x	12.70 x	—	52295	U04A	130.00 x	150.00 x	— x	15.00 x	—
57948	U019	127.00 x	152.40 x	— x	12.70 x	—	52295	U002	130.00 x	150.00 x	— x	17.00 x	—
57949	U004	127.00 x	152.40 x	— x	15.08 x	—	6383	CH	130.00 x	150.00 x	— x	17.00 x	—
—	U04A	127.00 x	152.40 x	— x	19.05 x	—	50955	U059	130.00 x	150.00 x	— x	80.00 x	—
—	CH	127.00 x	152.40 x	— x	48.00 x	—	54099	U001	130.00 x	151.00 x	— x	7.00 x	—
—	CH	127.00 x	152.40 x	— x	144.50 x	—	51284	U006	130.00 x	151.00 x	— x	11.00 x	—
6312	CH	127.00 x	152.40 x	— x	150.00 x	—	54100	U004	130.00 x	154.00 x	— x	12.00 x	—
—	CH	127.00 x	153.00 x	— x	48.00 x	—	50746	U030	130.00 x	154.00 x	— x	18.00 x	16.00
6244	CH	127.00 x	154.00 x	— x	32.00 x	—	54101	U001	130.00 x	155.00 x	— x	12.00 x	—
—	CH	127.00 x	155.00 x	— x	85.00 x	—	51542	U	130.00 x	155.00 x	— x	12.50 x	—
6345	CH	127.00 x	158.00 x	— x	84.00 x	—	54102	U003	130.00 x	155.00 x	— x	14.00 x	—



Cód	Mod	Di x	De x	Esp. x	Ha1 x	Ha2	Cód	Mod	Di x	De x	Esp. x	Ha1 x	Ha2
54103	U001	130.00 x	155.00 x	— x	15.00 x	—	50113	U004	133.35 x	156.17 x	— x	14.29 x	—
54104	U002	130.00 x	155.00 x	— x	15.00 x	—	54141	U019	133.35 x	158.75 x	— x	12.70 x	—
54105	U004	130.00 x	155.00 x	— x	18.00 x	—	50125	U046	133.35 x	160.14 x	— x	15.87 x	—
51633	U	130.00 x	155.00 x	— x	18.50 x	—	3362	C	133.35 x	202.80 x	— x	20.50 x	—
54106	U004	130.00 x	155.00 x	— x	20.00 x	—	3296	C	133.35 x	203.59 x	— x	31.75 x	—
—	CH	130.00 x	155.00 x	— x	56.00 x	—	—	U04A	133.40 x	146.10 x	— x	14.28 x	—
52885	U065	130.00 x	156.00 x	— x	15.00 x	—	—	U04A	133.40 x	149.20 x	— x	7.93 x	—
54107	U004	130.00 x	157.00 x	— x	15.00 x	—	54108	U04A	133.40 x	152.40 x	— x	15.87 x	—
—	CH	130.00 x	158.00 x	— x	61.00 x	—	—	U04A	133.40 x	158.80 x	— x	12.70 x	—
54109	U002	130.00 x	160.00 x	— x	13.50 x	—	51964	U	133.40 x	158.80 x	— x	15.87 x	—
51261	U019	130.00 x	160.00 x	— x	15.00 x	—	51964	U004	133.40 x	158.80 x	— x	15.87 x	—
54110	U019	130.00 x	160.00 x	— x	15.00 x	—	54142	U005	133.50 x	159.00 x	— x	16.00 x	—
8178	V	130.00 x	160.00 x	— x	15.00 x	—	54143	U001	133.50 x	160.00 x	— x	12.00 x	—
8178	V	130.00 x	160.00 x	— x	15.00 x	—	54144	U002	133.50 x	160.00 x	— x	12.00 x	—
54111	U002	130.00 x	160.00 x	— x	16.00 x	—	3110	C	133.50 x	200.00 x	— x	20.00 x	—
54112	U002	130.00 x	160.00 x	— x	18.00 x	—	54145	U019	133.60 x	159.00 x	— x	15.90 x	—
51807	U004	130.00 x	160.00 x	— x	18.00 x	—	50484	U002	133.70 x	151.80 x	— x	10.50 x	—
52222	U004	130.00 x	160.00 x	— x	18.00 x	—	53511	U031	133.85 x	146.00 x	— x	7.85 x	—
54113	U001	130.00 x	160.00 x	— x	26.00 x	—	54149	U008	134.00 x	145.00 x	— x	9.50 x	—
54114	U002	130.00 x	160.00 x	— x	26.00 x	—	54147	U007	134.00 x	145.00 x	— x	15.00 x	—
6212	CH	130.00 x	160.00 x	— x	28.00 x	—	54148	U008	134.00 x	145.00 x	— x	15.00 x	—
—	CH	130.00 x	160.00 x	— x	77.00 x	—	52398	U	134.00 x	150.00 x	— x	16.00 x	15.00
54115	U002	130.00 x	160.50 x	— x	15.00 x	—	52643	U04A	134.50 x	152.00 x	— x	15.85 x	—
8210	V	130.00 x	165.00 x	— x	14.00 x	—	8275	V	134.72 x	171.45 x	— x	9.52 x	—
54116	U001	130.00 x	165.00 x	— x	16.00 x	—	8235	V	135.00 x	145.00 x	— x	10.00 x	—
54117	U002	130.00 x	165.00 x	— x	16.00 x	—	54150	U005	135.00 x	145.00 x	— x	13.50 x	—
F7533	J	130.00 x	168.00 x	— x	24.00 x	30.00	54151	U006	135.00 x	145.00 x	— x	13.50 x	—
51939	U029	130.00 x	170.00 x	— x	15.00 x	—	6229	CH	135.00 x	145.00 x	— x	34.00 x	—
54118	U001	130.00 x	170.00 x	— x	20.00 x	—	54152	U002	135.00 x	146.70 x	— x	5.50 x	—
54119	U002	130.00 x	170.00 x	— x	20.00 x	—	8411	V	135.00 x	149.00 x	— x	18.00 x	—
54120	U001	130.00 x	175.00 x	— x	20.00 x	—	54161	U007	135.00 x	150.00 x	— x	9.00 x	—
54121	U002	130.00 x	175.00 x	— x	20.00 x	—	54153	U001	135.00 x	150.00 x	— x	10.00 x	—
50601	U002	130.17 x	139.70 x	— x	11.91 x	—	54154	U002	135.00 x	150.00 x	— x	10.00 x	—
50855	U033	130.17 x	152.40 x	— x	9.52 x	—	50048	U005	135.00 x	150.00 x	— x	12.70 x	—
54122	U019	130.18 x	149.23 x	— x	9.53 x	—	54156	U004	135.00 x	150.00 x	— x	15.00 x	—
54123	U002	130.18 x	152.40 x	— x	10.32 x	—	50996	U002	135.00 x	150.00 x	— x	16.00 x	—
—	U	130.20 x	146.10 x	— x	7.93 x	—	54157	U004	135.00 x	150.00 x	— x	16.00 x	—
—	U04A	130.20 x	149.20 x	— x	9.52 x	—	54158	U004	135.00 x	150.00 x	— x	16.00 x	—
54124	U004	130.50 x	145.00 x	— x	15.00 x	—	52928	U002	135.00 x	150.00 x	— x	18.00 x	—
54125	U007	130.97 x	152.40 x	— x	13.10 x	—	54159	U002	135.00 x	150.00 x	— x	18.00 x	—
54126	U007	131.00 x	143.00 x	— x	15.00 x	—	54160	U031	135.00 x	150.00 x	— x	18.00 x	—
54127	U008	131.00 x	143.00 x	— x	15.00 x	—	54155	U004	135.00 x	150.00 x	— x	156.00 x	—
54128	U003	131.00 x	144.00 x	— x	13.00 x	—	54162	U002	135.00 x	152.00 x	— x	11.00 x	—
54129	U002	131.00 x	150.50 x	— x	11.00 x	—	54163	U002	135.00 x	152.50 x	— x	18.00 x	—
50787	U002	131.00 x	152.40 x	— x	7.00 x	—	51487	U04A	135.00 x	153.00 x	— x	16.00 x	—
54130	U002	131.00 x	152.40 x	— x	7.00 x	—	54164	U002	135.00 x	155.00 x	— x	11.00 x	—
54131	U001	131.50 x	171.50 x	— x	20.00 x	—	54165	U004	135.00 x	155.00 x	— x	15.00 x	—
54132	U002	131.50 x	171.50 x	— x	20.00 x	—	51208	U04A	135.00 x	159.00 x	— x	15.00 x	—
50500	U061	131.76 x	139.70 x	— x	14.29 x	—	51208	U04A	135.00 x	159.00 x	— x	15.00 x	—
53205	U001	132.00 x	153.15 x	— x	15.80 x	—	54166	U001	135.00 x	160.00 x	— x	12.00 x	—
51589	U001	132.20 x	159.80 x	— x	16.00 x	—	54167	U002	135.00 x	160.00 x	— x	12.00 x	—
54133	U005	132.50 x	140.50 x	— x	14.00 x	—	54168	U004	135.00 x	160.00 x	— x	13.00 x	—
54134	U006	132.50 x	140.50 x	— x	14.00 x	—	50121	U002	135.00 x	160.00 x	— x	18.00 x	—
54135	U007	133.00 x	140.00 x	— x	8.70 x	—	54170	U004	135.00 x	160.00 x	— x	18.00 x	—
54136	U008	133.00 x	140.00 x	— x	8.70 x	—	50121	U004	135.00 x	160.00 x	— x	18.00 x	—
54137	U002	133.00 x	142.00 x	— x	7.00 x	—	54171	U004	135.00 x	160.00 x	— x	18.00 x	—
54138	U004	133.00 x	148.00 x	— x	15.00 x	—	54172	U001	135.00 x	160.00 x	— x	22.00 x	—
54139	U002	133.00 x	150.00 x	— x	10.00 x	—	54173	U002	135.00 x	160.00 x	— x	22.00 x	—
54140	U002	133.00 x	155.00 x	— x	10.00 x	—	—	CH	135.00 x	160.00 x	— x	56.50 x	—
—	CH	133.00 x	157.00 x	— x	45.50 x	—	F3670	J	135.00 x	164.00 x	— x	19.00 x	25.00
55564	U	133.00 x	173.00 x	— x	21.00 x	25.40	54174	U001	135.00 x	165.00 x	— x	15.00 x	—
—	U04A	133.35 x	146.95 x	— x	6.80 x	—	54175	U002	135.00 x	165.00 x	— x	15.00 x	—
51155	U	133.35 x	152.40 x	— x	9.52 x	—	54176	U004	135.00 x	165.00 x	— x	18.00 x	—
50395	U002	133.35 x	152.40 x	— x	9.52 x	—	54177	U004	135.00 x	165.00 x	— x	18.00 x	—
51435	U001	133.35 x	152.40 x	— x	12.70 x	—	54178	U001	135.00 x	165.50 x	— x	15.00 x	—
50128	U04A	133.35 x	155.37 x	— x	15.00 x	—	54179	U002	135.00 x	165.50 x	— x	15.00 x	—
—	CH	133.35 x	155.58 x	— x	47.00 x	—	—	CH	135.00 x	165.50 x	— x	65.50 x	—



Cód	Mod	Di x	De x	Esp. x	Ha1 x	Ha2	Cód	Mod	Di x	De x	Esp. x	Ha1 x	Ha2
54180	U001	135.00 x	180.00 x	— x	18.00 x	—	53495	U002	138.50 x	150.30 x	— x	16.00 x	—
54181	U002	135.00 x	180.00 x	— x	18.00 x	—	53341	U004	138.50 x	154.00 x	— x	5.00 x	—
54182	U002	135.00 x	182.00 x	— x	11.00 x	—	—	CH	138.50 x	163.50 x	— x	46.00 x	—
53401	U04A	135.60 x	152.40 x	— x	15.87 x	—	54213	U019	139.00 x	149.00 x	— x	7.00 x	—
54183	U004	136.00 x	150.00 x	— x	8.50 x	—	54211	U005	139.00 x	149.00 x	— x	12.00 x	—
50227	U065	136.00 x	150.00 x	— x	10.00 x	—	54212	U005	139.00 x	149.00 x	— x	14.00 x	—
51899	U002	136.00 x	152.00 x	— x	18.00 x	—	54214	U002	139.00 x	157.00 x	— x	7.00 x	—
50752	U006	136.00 x	152.40 x	— x	8.00 x	—	54215	U005	139.00 x	159.00 x	— x	7.00 x	—
54183	U002	136.00 x	152.60 x	— x	17.00 x	—	—	CH	139.00 x	168.00 x	— x	53.00 x	—
54184	U031	136.00 x	156.00 x	— x	10.00 x	—	54216	U001	139.00 x	176.00 x	— x	13.50 x	—
52712	U	136.00 x	158.00 x	— x	12.00 x	—	—	U04A	139.32 x	147.32 x	— x	10.92 x	—
8158	V	136.00 x	168.00 x	— x	13.00 x	—	55583	U04A	139.40 x	159.47 x	— x	15.87 x	—
6115	CH	136.00 x	168.00 x	— x	48.00 x	—	52276	U031	139.50 x	155.00 x	— x	10.00 x	—
51556	U	136.30 x	152.40 x	— x	10.00 x	—	54217	U007	139.50 x	157.50 x	— x	9.50 x	—
54185	U002	136.40 x	152.40 x	— x	9.00 x	—	59222	U002	139.50 x	158.80 x	— x	9.53 x	—
53019	U002	136.50 x	149.20 x	— x	6.35 x	—	54218	U005	139.70 x	147.60 x	— x	13.50 x	—
53019	U007	136.50 x	149.20 x	— x	6.35 x	—	54219	U006	139.70 x	147.64 x	— x	13.49 x	—
52474	U004	136.50 x	152.40 x	— x	7.90 x	—	52343	U004	139.70 x	152.40 x	— x	6.35 x	—
52474	U004	136.50 x	152.40 x	— x	7.90 x	—	52343	U004	139.70 x	152.40 x	— x	6.35 x	—
50873	U008	136.52 x	147.64 x	— x	9.52 x	7.94	50249	U002	139.70 x	152.40 x	— x	9.52 x	—
50926	U005	136.52 x	150.81 x	— x	8.73 x	—	54220	U001	139.70 x	152.40 x	— x	9.53 x	—
54187	U002	136.53 x	150.81 x	— x	9.53 x	—	53235	U04A	139.70 x	152.40 x	— x	12.00 x	—
54186	U002	136.53 x	150.81 x	— x	18.26 x	—	53235	U04A	139.70 x	152.40 x	— x	12.70 x	—
54188	U019	136.53 x	155.58 x	— x	9.53 x	—	—	U04A	139.70 x	152.40 x	— x	14.28 x	—
52700	U	136.53 x	155.58 x	— x	15.88 x	—	—	U04A	139.70 x	152.40 x	— x	19.05 x	—
52700	U004	136.53 x	155.58 x	— x	15.88 x	—	—	CH	139.70 x	152.40 x	— x	30.00 x	—
55644	UA-2	136.53 x	155.58 x	— x	15.88 x	—	52388	U031	139.70 x	155.50 x	— x	7.90 x	—
54189	U002	137.00 x	149.50 x	— x	11.00 x	—	50633	U004	139.70 x	157.16 x	— x	15.87 x	—
54190	U004	137.00 x	150.00 x	— x	11.00 x	—	50124	U004	139.70 x	158.55 x	— x	15.00 x	—
54191	U004	137.00 x	151.50 x	— x	8.00 x	—	54221	U004	139.70 x	158.75 x	— x	15.88 x	—
50854	U002	137.00 x	152.00 x	— x	8.00 x	—	—	U04A	139.70 x	158.80 x	— x	15.87 x	—
52340	U004	137.00 x	152.00 x	— x	9.00 x	—	6414	CH	139.70 x	165.10 x	— x	— x	—
52340	U004	137.00 x	152.00 x	— x	9.00 x	—	54222	U019	139.70 x	165.10 x	— x	12.70 x	—
52340	U004	137.00 x	152.00 x	— x	9.00 x	—	—	U04A	139.70 x	165.10 x	— x	12.70 x	—
54192	U007	137.00 x	153.30 x	— x	10.00 x	—	52696	U04A	139.70 x	177.80 x	— x	19.05 x	—
54193	U002	137.00 x	157.00 x	— x	10.00 x	—	—	U04A	139.70 x	177.80 x	— x	25.40 x	—
52896	U067	137.00 x	206.00 x	— x	10.50 x	—	3380	C	139.70 x	190.50 x	6.00 x	15.30 x	—
53382	U04A	137.50 x	151.20 x	— x	9.52 x	—	57971	U001	140.00 x	150.00 x	— x	5.00 x	—
50490	U022	137.50 x	156.90 x	— x	10.00 x	—	57972	U002	140.00 x	150.00 x	— x	5.00 x	—
54194	U001	138.00 x	150.00 x	— x	8.00 x	—	53111	U006	140.00 x	150.00 x	— x	10.50 x	—
54195	U002	138.00 x	150.00 x	— x	8.00 x	—	53111	U006	140.00 x	150.00 x	— x	11.50 x	—
54196	U007	138.00 x	152.40 x	— x	6.00 x	—	57973	U006	140.00 x	150.00 x	— x	11.80 x	—
53263	U002	138.00 x	152.40 x	— x	7.00 x	—	51473	U	140.00 x	150.00 x	— x	14.00 x	—
54197	U002	138.00 x	152.40 x	— x	7.00 x	—	57974	U002	140.00 x	150.00 x	— x	14.00 x	—
54198	U001	138.00 x	154.00 x	— x	8.00 x	—	57945	U007	140.00 x	150.00 x	— x	14.00 x	—
54199	U002	138.00 x	154.00 x	— x	8.00 x	—	57946	U008	140.00 x	150.00 x	— x	14.00 x	—
54200	U004	138.00 x	154.00 x	— x	8.00 x	—	50963	U002	140.00 x	150.00 x	— x	14.20 x	12.70
50414	U043	138.00 x	154.00 x	— x	9.00 x	—	57947	U007	140.00 x	152.00 x	— x	15.00 x	—
—	CH	138.00 x	155.00 x	— x	21.00 x	—	57948	U008	140.00 x	152.00 x	— x	15.00 x	—
55739	U004	138.00 x	158.00 x	— x	15.00 x	—	51378	U045	140.00 x	152.00 x	— x	18.00 x	—
50603	U002	138.00 x	160.00 x	— x	10.50 x	—	57949	U001	140.00 x	154.00 x	— x	7.00 x	—
54201	U001	138.00 x	160.00 x	— x	12.00 x	—	57950	U002	140.00 x	154.00 x	— x	7.00 x	—
54202	U002	138.00 x	160.00 x	— x	12.00 x	—	57951	U005	140.00 x	154.00 x	— x	14.00 x	—
54203	U001	138.00 x	160.00 x	— x	22.00 x	—	57952	U006	140.00 x	154.00 x	— x	14.00 x	—
54204	U002	138.00 x	160.00 x	— x	22.00 x	—	57953	U004	140.00 x	154.00 x	— x	19.00 x	—
—	CH	138.00 x	165.00 x	— x	44.50 x	—	55722	U002	140.00 x	155.00 x	— x	8.00 x	—
53000	U	138.00 x	167.00 x	— x	15.00 x	—	—	CH	140.00 x	155.00 x	— x	34.80 x	—
53000	U	138.00 x	167.00 x	— x	15.90 x	—	52906	U004	140.00 x	156.00 x	— x	10.00 x	—
54205	U001	138.00 x	170.00 x	— x	20.00 x	—	57954	U004	140.00 x	156.00 x	— x	10.00 x	—
54206	U002	138.00 x	170.00 x	— x	20.00 x	—	51422	U	140.00 x	158.00 x	— x	7.00 x	—
50789	U019	138.10 x	152.40 x	— x	7.00 x	—	51224	U002	140.00 x	158.00 x	— x	12.00 x	—
52178	U002	138.10 x	152.40 x	— x	7.94 x	—	8209	V	140.00 x	160.00 x	— x	8.00 x	—
54207	U019	138.11 x	147.64 x	— x	12.70 x	—	51902	U006	140.00 x	160.00 x	— x	9.00 x	14.00
54208	U007	138.11 x	148.26 x	— x	14.00 x	—	50145	U085	140.00 x	160.00 x	— x	9.00 x	14.00
54209	U002	138.11 x	152.40 x	— x	7.94 x	—	51941	U004	140.00 x	160.00 x	— x	10.00 x	—
—	CH	138.11 x	153.99 x	— x	28.00 x	—	51941	U004	140.00 x	160.00 x	— x	10.00 x	—
54210	U007	138.11 x	157.16 x	— x	10.32 x	—	51941	U004	140.00 x	160.00 x	— x	10.00 x	—



Cód	Mod	Di x	De x	Esp. x	Ha1 x	Ha2	Cód	Mod	Di x	De x	Esp. x	Ha1 x	Ha2
51209	U004	140.00 x	160.00 x	— x	12.00 x	—	50625	U024	143.00 x	154.00 x	— x	15.00 x	—
57955	U005	140.00 x	160.00 x	— x	14.00 x	—	57984	U002	143.00 x	158.00 x	— x	12.00 x	—
8356	V	140.00 x	160.00 x	— x	14.00 x	—	50605	U004	143.00 x	158.00 x	— x	12.00 x	—
50947	U	140.00 x	160.00 x	— x	15.00 x	—	—	CH	143.00 x	163.00 x	— x	52.00 x	—
50122	U003	140.00 x	160.00 x	— x	15.00 x	—	57985	U003	143.00 x	170.00 x	— x	19.00 x	—
59225	U004	140.00 x	160.00 x	— x	15.00 x	—	57986	U001	143.00 x	175.00 x	— x	19.00 x	—
50947	U004	140.00 x	160.00 x	— x	15.00 x	—	3265	C	143.00 x	178.00 x	4.00 x	14.50 x	—
50947	U004	140.00 x	160.00 x	— x	15.00 x	—	51349	U026	143.80 x	215.50 x	— x	27.00 x	—
50908	U005	140.00 x	160.00 x	— x	15.00 x	—	57987	U004	144.00 x	160.00 x	— x	12.00 x	—
6396	CH	140.00 x	160.00 x	— x	22.50 x	—	52326	U007	144.00 x	160.00 x	— x	16.00 x	14.00
8184	V	140.00 x	165.00 x	— x	11.00 x	—	57988	U019	144.00 x	165.00 x	— x	15.00 x	—
52608	U031	140.00 x	165.00 x	— x	13.00 x	—	—	CH	144.00 x	168.00 x	— x	49.00 x	—
57956	U002	140.00 x	165.00 x	— x	14.00 x	—	8418	V	144.50 x	164.50 x	— x	10.00 x	—
51288	U	140.00 x	165.00 x	— x	22.00 x	—	57989	U005	145.00 x	155.00 x	— x	13.50 x	—
6356	CH	140.00 x	165.00 x	— x	46.00 x	—	57990	U006	145.00 x	155.00 x	— x	13.50 x	—
—	CH	140.00 x	165.00 x	— x	60.00 x	—	57991	U004	145.00 x	157.50 x	— x	9.00 x	—
57957	U019	140.00 x	168.00 x	— x	18.00 x	—	8236	V	145.00 x	158.00 x	— x	9.40 x	—
57958	U002	140.00 x	170.00 x	— x	15.00 x	—	53161	U001	145.00 x	160.00 x	— x	10.00 x	—
57959	U019	140.00 x	170.00 x	— x	15.00 x	—	—	CH	145.00 x	161.00 x	— x	25.00 x	—
52622	U021	140.00 x	170.00 x	— x	15.00 x	—	57992	U004	145.00 x	165.00 x	— x	15.00 x	—
57960	U001	140.00 x	170.00 x	— x	17.00 x	—	6458	CH	145.00 x	165.00 x	— x	24.00 x	—
57961	U002	140.00 x	170.00 x	— x	17.00 x	—	57993	U002	145.00 x	165.00 x	— x	27.00 x	—
57962	U004	140.00 x	170.00 x	— x	18.00 x	—	52241	U	145.00 x	169.00 x	— x	20.00 x	—
53306	U04A	140.00 x	170.00 x	— x	18.00 x	—	8164	V	145.00 x	170.00 x	— x	12.00 x	—
57963	U001	140.00 x	170.00 x	— x	20.00 x	—	57994	U001	145.00 x	170.00 x	— x	15.00 x	—
57964	U002	140.00 x	170.00 x	— x	20.00 x	—	57995	U002	145.00 x	170.00 x	— x	15.00 x	—
57965	U001	140.00 x	170.00 x	— x	26.00 x	—	57996	U004	145.00 x	170.00 x	— x	18.00 x	—
57966	U002	140.00 x	170.00 x	— x	26.00 x	—	57997	U001	145.00 x	170.00 x	— x	22.00 x	—
6193	CH	140.00 x	170.00 x	— x	49.00 x	—	57998	U002	145.00 x	170.00 x	— x	22.00 x	—
—	CH	140.00 x	170.00 x	— x	79.50 x	—	6121	CH	145.00 x	170.00 x	— x	38.00 x	—
8300	V	140.00 x	172.00 x	— x	15.50 x	—	57999	U002	145.00 x	171.00 x	— x	20.00 x	—
57967	U001	140.00 x	175.00 x	— x	20.00 x	—	58000	U001	145.00 x	175.00 x	— x	15.00 x	—
57968	U002	140.00 x	175.00 x	— x	20.00 x	—	58001	U002	145.00 x	175.00 x	— x	15.00 x	—
—	CH	140.00 x	175.00 x	— x	168.00 x	—	58002	U019	145.00 x	175.00 x	— x	15.00 x	—
57969	U001	140.00 x	180.00 x	— x	20.00 x	—	53126	U001	145.00 x	175.00 x	— x	18.00 x	—
57970	U002	140.00 x	180.00 x	— x	20.00 x	—	58003	U004	145.00 x	175.00 x	— x	18.00 x	—
57971	U001	140.00 x	190.00 x	— x	25.00 x	—	58004	U001	145.00 x	175.00 x	— x	26.00 x	—
57972	U002	140.00 x	190.00 x	— x	25.00 x	—	58005	U002	145.00 x	175.00 x	— x	26.00 x	—
57973	U007	140.50 x	146.00 x	— x	6.00 x	—	—	CH	145.00 x	175.00 x	— x	57.00 x	—
52997	U04A	140.50 x	152.70 x	— x	14.70 x	—	58006	U001	145.00 x	177.00 x	— x	15.00 x	—
3491	C001	140.50 x	175.00 x	— x	17.00 x	—	58007	U002	145.00 x	177.00 x	— x	15.00 x	—
57974	U007	141.00 x	150.00 x	— x	14.00 x	—	6334	CH	145.00 x	177.80 x	— x	— x	—
57975	U008	141.00 x	150.00 x	— x	14.00 x	—	53378	U001	145.00 x	178.00 x	— x	15.00 x	—
52416	U	141.00 x	153.00 x	— x	6.35 x	—	58008	U002	145.00 x	178.00 x	— x	15.00 x	—
51872	U002	141.00 x	165.00 x	— x	10.00 x	—	58009	U001	145.00 x	185.00 x	— x	20.00 x	—
8081	V	141.00 x	166.00 x	— x	6.40 x	—	58010	U002	145.00 x	185.00 x	— x	20.00 x	—
—	CH	141.00 x	171.00 x	— x	175.00 x	—	—	C	145.00 x	250.00 x	— x	40.00 x	—
57976	U004	141.29 x	160.34 x	— x	11.11 x	—	58011	U002	146.00 x	167.00 x	— x	17.50 x	—
50518	U031	141.30 x	215.50 x	— x	27.00 x	—	8344	V	146.00 x	168.00 x	— x	10.50 x	—
50518	U031	141.30 x	215.50 x	— x	27.00 x	—	—	CH	146.00 x	168.00 x	— x	43.00 x	—
52921	U	141.50 x	154.90 x	— x	7.50 x	—	—	CH	146.00 x	171.50 x	— x	78.00 x	—
52921	U007	141.50 x	154.90 x	— x	7.50 x	—	—	CH	146.00 x	172.50 x	— x	51.00 x	—
57977	U001	142.00 x	150.00 x	— x	8.00 x	—	—	CH	146.00 x	186.00 x	— x	105.00 x	—
57978	U002	142.00 x	150.00 x	— x	8.00 x	—	58012	U001	146.00 x	190.00 x	— x	20.00 x	—
51986	U	142.00 x	150.00 x	— x	12.00 x	—	58013	U002	146.00 x	190.00 x	— x	20.00 x	—
52262	U004	142.00 x	160.00 x	— x	13.00 x	—	50640	U008	146.05 x	152.40 x	— x	15.87 x	—
59301	U04A	142.00 x	162.00 x	— x	16.00 x	—	50640	U04A	146.05 x	152.40 x	— x	15.87 x	—
57979	U002	142.00 x	190.00 x	— x	25.00 x	—	58014	U004	146.05 x	157.16 x	— x	6.35 x	—
51354	U026	142.30 x	215.50 x	— x	27.00 x	—	8251	V	146.05 x	171.45 x	— x	9.52 x	—
50393	U056	142.87 x	173.03 x	— x	15.00 x	—	—	CH	146.05 x	171.45 x	— x	46.00 x	—
—	CH	142.88 x	158.75 x	— x	32.00 x	—	—	CH	146.05 x	171.45 x	— x	53.00 x	—
52067	U024	142.90 x	150.30 x	— x	12.70 x	—	58015	U019	146.05 x	177.80 x	— x	12.70 x	—
—	U04A	142.90 x	161.90 x	— x	15.87 x	—	50970	U003	146.05 x	177.80 x	— x	20.00 x	—
57981	U001	143.00 x	151.00 x	— x	8.00 x	—	50969	U002	146.05 x	177.80 x	— x	20.64 x	—
57980	U001	143.00 x	151.00 x	— x	8.00 x	—	50970	U003	146.05 x	177.80 x	— x	20.64 x	—
57982	U002	143.00 x	151.00 x	— x	8.00 x	—	—	CH	146.05 x	177.80 x	— x	56.00 x	—
57983	U019	143.00 x	151.00 x	— x	13.00 x	—	3200	C	146.05 x	198.44 x	5.30 x	20.64 x	—





Cód	Mod	Di x	De x	Esp. x	Ha1 x	Ha2	Cód	Mod	Di x	De x	Esp. x	Ha1 x	Ha2
—	U04A	146.10 x	165.10 x	— x	15.87 x	—	6429	CH	150.00 x	180.00 x	— x	31.00 x	—
—	U04A	146.10 x	165.10 x	— x	19.05 x	—	58046	U001	150.00 x	181.70 x	— x	16.00 x	—
58016	U001	146.10 x	171.50 x	— x	22.00 x	—	58047	U002	150.00 x	181.70 x	— x	16.00 x	—
58017	U002	146.10 x	171.50 x	— x	22.00 x	—	58048	U002	150.00 x	183.90 x	— x	15.00 x	—
58018	U002	146.10 x	171.50 x	— x	22.00 x	—	58049	U001	150.00 x	184.00 x	— x	15.00 x	—
55748	U004	147.00 x	160.00 x	— x	11.00 x	—	58050	U002	150.00 x	185.00 x	— x	20.00 x	—
58019	U004	147.00 x	160.00 x	— x	12.00 x	—	51784	U004	150.00 x	185.00 x	— x	20.00 x	—
52471	U04A	147.00 x	165.00 x	— x	16.00 x	—	59432	U04A	150.00 x	185.00 x	— x	23.00 x	—
58020	U002	147.00 x	171.50 x	— x	19.00 x	—	53419	U04A	150.00 x	185.00 x	— x	24.00 x	—
52284	U004	147.00 x	173.00 x	— x	20.00 x	—	55711	U	150.00 x	185.00 x	— x	37.00 x	—
53120	U	147.50 x	159.50 x	— x	5.80 x	—	—	CH	150.00 x	187.00 x	— x	69.00 x	—
53120	U	147.50 x	159.50 x	— x	6.90 x	—	58051	U002	150.00 x	187.50 x	— x	17.50 x	—
—	CH	147.64 x	165.10 x	— x	25.00 x	—	58052	U001	150.00 x	190.00 x	— x	20.00 x	—
58021	U007	148.00 x	160.00 x	— x	15.50 x	—	58053	U002	150.00 x	190.00 x	— x	20.00 x	—
58022	U008	148.00 x	160.00 x	— x	15.50 x	—	6370	CH	150.00 x	190.00 x	— x	51.50 x	—
51688	U001	148.00 x	170.00 x	— x	15.00 x	—	58054	U001	150.00 x	191.00 x	— x	24.00 x	—
58023	U008	148.50 x	175.00 x	— x	16.00 x	—	3388	C	150.00 x	200.00 x	5.00 x	20.00 x	—
6351	CH	149.00 x	163.00 x	— x	21.50 x	—	50117	U003	151.00 x	169.00 x	— x	11.80 x	—
51345	U003	149.00 x	165.00 x	— x	7.90 x	—	F7110	W	151.00 x	179.00 x	— x	8.00 x	—
58024	U003	149.00 x	165.00 x	— x	7.90 x	—	55571	U04A	151.40 x	178.40 x	— x	17.46 x	—
58025	U001	149.00 x	165.00 x	— x	9.50 x	—	53245	UL	151.50 x	172.00 x	— x	5.00 x	—
58026	U002	149.00 x	165.00 x	— x	9.50 x	—	58055	U001	151.50 x	185.00 x	— x	15.00 x	—
58027	U002	149.00 x	170.00 x	— x	10.00 x	—	58056	U002	151.50 x	185.00 x	— x	15.00 x	—
—	CH	149.00 x	181.00 x	— x	55.50 x	—	58057	U001	152.00 x	164.00 x	— x	12.00 x	—
52493	U029	149.00 x	187.30 x	— x	16.00 x	—	58058	U002	152.00 x	164.00 x	— x	12.00 x	—
52496	U029	149.00 x	187.30 x	— x	16.00 x	—	52727	U	152.00 x	176.50 x	— x	14.00 x	—
52138	U021	149.20 x	172.60 x	— x	15.89 x	—	58059	U019	152.00 x	176.50 x	— x	14.00 x	—
53309	U04A	149.22 x	168.27 x	— x	15.87 x	—	51379	U	152.00 x	177.80 x	— x	11.20 x	—
58028	U007	149.23 x	157.16 x	— x	4.76 x	—	53038	U001	152.00 x	177.80 x	— x	15.00 x	—
58029	U007	150.00 x	158.00 x	— x	8.00 x	—	—	CH	152.00 x	184.00 x	— x	56.00 x	—
55747	U	150.00 x	160.00 x	— x	10.00 x	—	—	CH	152.00 x	193.00 x	— x	42.00 x	—
58030	U004	150.00 x	160.00 x	— x	12.00 x	—	58060	U007	152.40 x	160.34 x	— x	4.76 x	—
58031	U005	150.00 x	160.00 x	— x	13.50 x	—	58061	U002	152.40 x	165.10 x	— x	11.91 x	—
58032	U006	150.00 x	160.00 x	— x	14.00 x	—	6053	CH	152.40 x	165.10 x	— x	21.43 x	—
52093	U005	150.00 x	166.00 x	— x	8.00 x	—	6053	CH	152.40 x	165.10 x	— x	26.00 x	—
F10192	W	150.00 x	166.00 x	— x	8.00 x	—	51759	U	152.40 x	168.30 x	— x	7.93 x	—
8169	V	150.00 x	170.00 x	— x	9.00 x	—	51759	U	152.40 x	168.30 x	— x	7.93 x	—
58033	U002	150.00 x	170.00 x	— x	10.00 x	—	58062	U019	152.40 x	171.45 x	— x	9.53 x	—
53352	U04A	150.00 x	170.00 x	— x	10.00 x	—	—	CH	152.40 x	171.45 x	— x	32.50 x	—
53352	U04A	150.00 x	170.00 x	— x	10.00 x	—	—	U04A	152.40 x	171.50 x	— x	9.52 x	—
51115	U	150.00 x	170.00 x	— x	13.00 x	—	—	U04A	152.40 x	171.50 x	— x	15.87 x	—
59460	U040	150.00 x	170.00 x	— x	14.50 x	—	58063	U001	152.40 x	171.80 x	— x	10.30 x	—
55693	U004	150.00 x	170.00 x	— x	15.00 x	—	8319	V	152.40 x	177.80 x	— x	11.11 x	—
55663	U004	150.00 x	170.00 x	— x	15.00 x	—	51869	U	152.40 x	177.80 x	— x	12.70 x	—
58034	U001	150.00 x	170.00 x	— x	18.00 x	—	6404	CH	152.40 x	177.80 x	— x	43.00 x	—
58035	U002	150.00 x	170.00 x	— x	18.00 x	—	6339	CH	152.40 x	180.00 x	— x	4.00 x	—
6270	CH	150.00 x	170.00 x	— x	30.00 x	—	58064	U019	152.40 x	184.15 x	— x	12.70 x	—
8141	V	150.00 x	175.00 x	— x	14.00 x	—	—	U04A	152.40 x	190.50 x	— x	19.05 x	—
52189	U	150.00 x	175.00 x	— x	15.00 x	—	58065	U005	152.50 x	160.50 x	— x	14.00 x	—
51871	U004	150.00 x	175.00 x	— x	19.50 x	—	58066	U006	152.50 x	160.50 x	— x	14.00 x	—
58036	U001	150.00 x	175.00 x	— x	20.00 x	—	58067	U003	152.50 x	170.50 x	— x	10.00 x	—
58037	U002	150.00 x	175.00 x	— x	20.00 x	—	—	CH	152.50 x	178.50 x	— x	50.50 x	—
6098	CH	150.00 x	175.00 x	— x	39.00 x	—	58068	U001	152.50 x	192.00 x	— x	20.00 x	—
6098	CH	150.00 x	175.00 x	— x	42.50 x	—	58069	U002	152.50 x	192.00 x	— x	20.00 x	—
53272	U002	150.00 x	179.00 x	— x	15.00 x	—	51370	U003	152.60 x	178.00 x	— x	15.90 x	—
53272	U002	150.00 x	179.00 x	— x	15.00 x	—	52202	U004	152.65 x	171.45 x	— x	15.89 x	—
58038	U019	150.00 x	179.00 x	— x	15.00 x	—	58070	U001	153.00 x	168.00 x	— x	8.00 x	—
58039	U001	150.00 x	180.00 x	— x	15.00 x	—	58071	U002	153.00 x	168.00 x	— x	8.00 x	—
58040	U002	150.00 x	180.00 x	— x	15.00 x	—	51325	U001	153.00 x	172.00 x	— x	12.00 x	—
58041	U001	150.00 x	180.00 x	— x	17.00 x	—	52267	U	153.00 x	176.00 x	— x	10.50 x	—
58042	U002	150.00 x	180.00 x	— x	17.00 x	—	58072	U001	153.00 x	185.00 x	— x	15.00 x	—
51393	U004	150.00 x	180.00 x	— x	18.00 x	—	58073	U002	153.00 x	185.00 x	— x	15.00 x	—
51393	U004	150.00 x	180.00 x	— x	18.00 x	—	58074	U019	153.00 x	185.00 x	— x	25.00 x	—
53418	U026	150.00 x	180.00 x	— x	18.00 x	—	58075	U001	153.00 x	194.00 x	— x	20.00 x	—
58043	U002	150.00 x	180.00 x	— x	19.00 x	—	58076	U002	153.00 x	194.00 x	— x	20.00 x	—
58044	U001	150.00 x	180.00 x	— x	26.00 x	—	3509	C	153.00 x	280.00 x	— x	36.00 x	—
58045	U002	150.00 x	180.00 x	— x	26.00 x	—	50466	U086	153.06 x	172.30 x	— x	12.00 x	—



Cód	Mod	Di x	De x	Esp. x	Ha1 x	Ha2	Cód	Mod	Di x	De x	Esp. x	Ha1 x	Ha2
58078	U007	154.00 x	165.00 x	— x	15.00 x	—	53499	U004	160.00 x	175.00 x	— x	8.50 x	—
58079	U008	154.00 x	165.00 x	— x	15.00 x	—	58115	U001	160.00 x	175.00 x	— x	12.00 x	—
58080	U001	154.00 x	194.00 x	— x	20.00 x	—	58116	U002	160.00 x	175.00 x	— x	12.00 x	—
58081	U002	154.00 x	194.00 x	— x	20.00 x	—	—	U04A	160.00 x	176.00 x	— x	12.70 x	—
51351	U026	154.80 x	215.50 x	— x	27.00 x	—	—	U025	160.00 x	178.00 x	— x	9.00 x	—
58082	U004	155.00 x	165.00 x	— x	15.00 x	—	52968	U001	160.00 x	178.00 x	— x	14.00 x	—
58083	U007	155.00 x	167.00 x	— x	15.00 x	—	52968	U001	160.00 x	178.00 x	— x	14.00 x	—
58084	U008	155.00 x	167.00 x	— x	15.00 x	—	58117	U004	160.00 x	178.00 x	— x	16.00 x	—
51227	U002	155.00 x	167.00 x	— x	15.50 x	14.50	51692	U04A	160.00 x	180.00 x	— x	10.00 x	—
8284	V	155.00 x	175.00 x	— x	9.20 x	—	58118	U002	160.00 x	180.00 x	— x	14.00 x	—
8284	V	155.00 x	175.00 x	— x	9.20 x	—	51279	U007	160.00 x	180.00 x	— x	14.50 x	—
58085	U003	155.00 x	175.00 x	— x	9.50 x	—	50877	U004	160.00 x	180.00 x	— x	15.00 x	—
50359	U026	155.00 x	175.00 x	— x	10.00 x	—	50877	U004	160.00 x	180.00 x	— x	15.00 x	—
58086	U001	155.00 x	175.00 x	— x	13.00 x	—	58119	U006	160.00 x	180.00 x	— x	15.00 x	—
58087	U002	155.00 x	175.00 x	— x	13.00 x	—	8324	V	160.00 x	180.00 x	— x	15.00 x	—
59267	U033	155.00 x	175.00 x	— x	13.00 x	—	—	CH	160.00 x	180.00 x	— x	47.00 x	—
58088	U004	155.00 x	175.00 x	— x	15.00 x	—	51142	U	160.00 x	182.00 x	— x	12.50 x	—
58089	U001	155.00 x	185.00 x	— x	15.00 x	—	52816	U	160.00 x	185.00 x	— x	14.50 x	13.50
58090	U002	155.00 x	185.00 x	— x	15.00 x	—	58120	U001	160.00 x	185.00 x	— x	15.00 x	—
58091	U001	155.00 x	185.00 x	— x	26.00 x	—	58121	U002	160.00 x	185.00 x	— x	15.00 x	—
58092	U002	155.00 x	185.00 x	— x	26.00 x	—	58122	U001	160.00 x	185.00 x	— x	18.00 x	—
—	CH	155.00 x	185.00 x	— x	66.50 x	—	55553	U	160.00 x	185.00 x	— x	20.00 x	—
3178	C	155.00 x	190.00 x	4.00 x	18.00 x	—	52006	U004	160.00 x	187.00 x	— x	15.00 x	—
51992	U004	155.00 x	190.00 x	— x	18.00 x	—	58123	U002	160.00 x	187.00 x	— x	18.00 x	—
58093	U001	155.00 x	195.00 x	— x	20.00 x	—	58124	U003	160.00 x	188.00 x	— x	15.00 x	—
58094	U002	155.00 x	195.00 x	— x	20.00 x	—	58125	U001	160.00 x	190.00 x	— x	10.00 x	—
58095	U003	155.58 x	204.79 x	— x	23.81 x	—	58126	U002	160.00 x	190.00 x	— x	10.00 x	—
51389	U074	155.60 x	207.90 x	— x	26.20 x	—	58127	U001	160.00 x	190.00 x	— x	15.00 x	—
58096	U002	156.00 x	174.00 x	— x	10.00 x	—	58128	U002	160.00 x	190.00 x	— x	15.00 x	—
58097	U002	156.00 x	176.00 x	— x	13.00 x	—	51531	U002	160.00 x	190.00 x	— x	15.00 x	—
58098	U003	157.00 x	170.00 x	— x	7.00 x	—	58129	U019	160.00 x	190.00 x	— x	15.00 x	—
3092	C	157.16 x	207.96 x	5.50 x	23.81 x	—	58130	U004	160.00 x	190.00 x	— x	22.00 x	—
59308	U027	157.40 x	198.60 x	— x	20.00 x	—	6352	CH	160.00 x	190.00 x	— x	51.00 x	—
3496	C	157.50 x	196.00 x	— x	22.00 x	—	—	CH	160.00 x	190.00 x	— x	59.00 x	—
58099	U001	158.00 x	170.00 x	— x	10.00 x	—	3190	C	160.00 x	200.00 x	4.00 x	18.00 x	—
58100	U002	158.00 x	170.00 x	— x	10.00 x	—	58131	U001	160.00 x	200.00 x	— x	20.00 x	—
58101	U003	158.00 x	170.00 x	— x	14.00 x	—	58132	U002	160.00 x	200.00 x	— x	20.00 x	—
58102	U007	158.00 x	170.00 x	— x	15.00 x	—	58133	U003	160.00 x	200.00 x	— x	20.00 x	—
58103	U008	158.00 x	170.00 x	— x	15.00 x	—	58134	U019	160.00 x	200.00 x	— x	20.00 x	—
6134	CH	158.00 x	180.00 x	— x	33.00 x	—	8363	V	160.00 x	200.00 x	— x	20.00 x	—
—	CH	158.00 x	188.00 x	— x	55.00 x	—	50238	U004	160.14 x	188.91 x	— x	22.22 x	—
58104	U001	158.00 x	190.00 x	— x	15.00 x	—	51171	U	160.14 x	188.92 x	— x	14.39 x	—
58105	U002	158.00 x	190.00 x	— x	15.00 x	—	52230	U	161.00 x	197.00 x	— x	13.00 x	—
58106	U002	158.00 x	192.00 x	— x	15.00 x	—	52229	U026	161.00 x	215.50 x	— x	27.00 x	—
F2710	J	158.00 x	192.00 x	— x	19.00 x	25.00	51061	U	161.50 x	187.00 x	— x	15.00 x	—
53307	U04A	158.22 x	168.27 x	— x	14.87 x	—	51061	U004	161.50 x	187.00 x	— x	15.00 x	—
58107	U002	158.75 x	177.80 x	— x	9.13 x	—	58135	U002	161.50 x	204.50 x	— x	20.00 x	—
51391	U	158.75 x	177.80 x	— x	9.52 x	—	58136	U007	161.93 x	174.63 x	— x	7.14 x	—
51834	U04A	158.75 x	177.80 x	— x	15.87 x	—	58137	U005	162.00 x	175.00 x	— x	8.00 x	—
58108	U019	158.75 x	190.50 x	— x	15.88 x	—	58138	U001	162.00 x	179.00 x	— x	13.00 x	—
6275	CH	158.75 x	190.54 x	— x	53.87 x	—	58139	U001	162.00 x	182.00 x	— x	10.00 x	—
—	U04A	158.80 x	171.50 x	— x	6.35 x	—	58140	U002	162.00 x	182.00 x	— x	10.00 x	—
—	U04A	158.80 x	174.60 x	— x	7.93 x	—	58141	U004	162.00 x	182.00 x	— x	15.00 x	—
58109	U001	158.80 x	190.50 x	— x	25.00 x	—	—	CH	162.00 x	189.00 x	— x	64.00 x	—
58110	U002	158.80 x	190.50 x	— x	25.00 x	—	—	CH	162.00 x	192.00 x	— x	39.00 x	—
59421	UL	159.00 x	178.00 x	— x	12.00 x	15.00	51079	U007	162.00 x	198.00 x	— x	14.00 x	—
—	CH	159.00 x	182.00 x	— x	38.00 x	—	58142	U003	162.00 x	200.00 x	— x	17.00 x	—
50638	U033	159.00 x	190.00 x	— x	20.00 x	—	53462	U04A	163.00 x	175.00 x	— x	10.00 x	—
—	CH	159.00 x	193.00 x	— x	47.00 x	—	53462	U04A	163.00 x	175.00 x	— x	10.00 x	—
3356	C	159.00 x	203.20 x	— x	16.00 x	—	58143	U007	163.00 x	175.00 x	— x	15.00 x	—
52752	U	159.50 x	173.50 x	— x	10.50 x	—	58144	U008	163.00 x	175.00 x	— x	15.00 x	—
52751	U	159.50 x	173.50 x	— x	10.50 x	—	53196	U002	163.00 x	189.00 x	— x	12.00 x	—
58111	U005	160.00 x	169.00 x	— x	13.50 x	—	3348	C	163.00 x	203.00 x	— x	17.00 x	—
58112	U006	160.00 x	169.00 x	— x	13.50 x	—	3411	C	163.00 x	203.00 x	— x	18.00 x	—
58113	U005	160.00 x	172.00 x	— x	15.00 x	—	53452	U004	163.10 x	177.80 x	— x	7.94 x	—
58114	U006	160.00 x	172.00 x	— x	15.00 x	—	58145	U	163.31 x	177.80 x	— x	7.94 x	—
59453	UL	160.00 x	173.00 x	— x	7.00 x	10.20	50439	U002	163.31 x	177.80 x	— x	7.94 x	—



Cód	Mod	Di x	De x	Esp. x	Ha1 x	Ha2	Cód	Mod	Di x	De x	Esp. x	Ha1 x	Ha2
53452	U004	163.31 x	177.80 x	— x	7.94 x	—	58174	U	167.00 x	186.00 x	— x	12.00 x	13.00
—	CH	163.51 x	178.20 x	— x	42.00 x	—	50635	U006	167.00 x	186.00 x	— x	13.00 x	12.00
—	CH	163.51 x	190.50 x	— x	53.50 x	—	50635	U006	167.00 x	186.00 x	— x	13.00 x	—
3385	C	163.60 x	180.60 x	— x	9.00 x	—	—	CH	167.00 x	187.00 x	— x	48.00 x	—
58146	U001	164.00 x	180.00 x	— x	18.00 x	—	52084	U005	167.00 x	191.00 x	— x	13.00 x	—
58147	U004	164.00 x	184.00 x	— x	15.00 x	—	52084	U005	167.00 x	191.00 x	— x	13.00 x	—
6448	CH	164.00 x	184.00 x	— x	20.00 x	—	—	CH	167.00 x	195.00 x	— x	64.50 x	—
8294	V	164.00 x	191.00 x	— x	8.00 x	—	58175	U005	167.00 x	197.00 x	— x	20.00 x	—
3078	C	164.00 x	198.00 x	4.50 x	18.00 x	—	3240	C	167.00 x	203.20 x	— x	17.00 x	—
—	U04A	164.80 x	172.80 x	— x	10.92 x	—	51353	U026	167.40 x	215.50 x	— x	27.00 x	—
58148	U005	165.00 x	173.00 x	— x	13.50 x	—	53463	U04A	168.00 x	180.00 x	— x	10.00 x	—
58149	U001	165.00 x	180.00 x	— x	7.50 x	—	53463	U04A	168.00 x	180.00 x	— x	10.00 x	—
58150	U002	165.00 x	180.00 x	— x	7.50 x	—	52375	U001	168.00 x	183.00 x	— x	15.00 x	—
58151	U001	165.00 x	180.00 x	— x	8.00 x	—	58176	U001	168.00 x	192.00 x	— x	10.00 x	—
58152	U002	165.00 x	180.00 x	— x	8.00 x	—	58177	U002	168.00 x	192.00 x	— x	10.00 x	—
51853	U004	165.00 x	180.00 x	— x	9.00 x	—	58178	U002	168.00 x	200.00 x	— x	15.00 x	—
58153	U004	165.00 x	180.00 x	— x	9.00 x	—	3167	C	168.00 x	207.00 x	3.80 x	17.00 x	—
58154	U007	165.00 x	184.15 x	— x	11.11 x	—	58179	U031	168.00 x	212.50 x	— x	23.81 x	—
52353	U	165.00 x	185.00 x	— x	13.00 x	—	50225	U074	168.07 x	196.85 x	— x	19.05 x	—
58155	U001	165.00 x	187.00 x	— x	9.00 x	—	3475	C	168.20 x	203.20 x	— x	18.20 x	—
58156	U002	165.00 x	187.00 x	— x	9.00 x	—	—	CH	168.28 x	190.50 x	— x	40.00 x	—
53194	U002	165.00 x	187.00 x	— x	12.00 x	—	3294	C	168.30 x	203.20 x	— x	15.08 x	—
—	CH	165.00 x	188.00 x	— x	46.50 x	—	58180	U001	168.50 x	200.00 x	— x	15.00 x	—
51727	U	165.00 x	190.00 x	— x	13.00 x	—	58181	U002	168.50 x	200.00 x	— x	15.00 x	—
52056	U001	165.00 x	190.00 x	— x	13.00 x	—	8240	V	169.00 x	185.00 x	— x	7.00 x	—
52055	U04A	165.00 x	190.00 x	— x	13.00 x	—	—	CH	169.00 x	194.00 x	— x	41.50 x	—
51748	U	165.00 x	190.00 x	— x	15.00 x	—	6357	CH	169.00 x	194.50 x	— x	46.00 x	—
51748	U003	165.00 x	190.00 x	— x	15.00 x	—	—	CH	169.00 x	199.00 x	— x	65.50 x	—
50654	U004	165.00 x	190.00 x	— x	18.00 x	—	50915	U002	169.00 x	203.40 x	— x	14.00 x	—
50937	U	165.00 x	193.00 x	— x	14.00 x	—	58182	U001	169.00 x	209.00 x	— x	20.00 x	—
55578	U	165.00 x	195.00 x	— x	15.00 x	—	58183	U002	169.00 x	209.00 x	— x	20.00 x	—
58157	U002	165.00 x	195.00 x	— x	15.00 x	—	53225	U04A	169.70 x	195.00 x	— x	19.05 x	—
58158	U001	165.00 x	195.00 x	— x	26.00 x	—	58184	U005	170.00 x	182.00 x	— x	15.00 x	—
58159	U002	165.00 x	195.00 x	— x	26.00 x	—	58185	U006	170.00 x	182.00 x	— x	15.00 x	—
—	CH	165.00 x	195.00 x	— x	73.00 x	—	—	CH	170.00 x	184.00 x	— x	25.00 x	—
3239	C	165.00 x	198.00 x	4.00 x	14.00 x	—	58186	U004	170.00 x	185.00 x	— x	15.00 x	—
3507	C	165.00 x	200.00 x	4.00 x	15.00 x	—	50685	U004	170.00 x	185.00 x	— x	15.00 x	9.00
3429	C	165.00 x	202.00 x	— x	20.00 x	—	50094	U001	170.00 x	189.00 x	— x	11.00 x	—
58160	U019	165.00 x	203.00 x	— x	19.00 x	—	58187	U001	170.00 x	190.00 x	— x	10.00 x	—
58161	U001	165.00 x	206.00 x	— x	20.00 x	—	58188	U002	170.00 x	190.00 x	— x	10.00 x	—
58162	U002	165.00 x	206.00 x	— x	20.00 x	—	50790	U004	170.00 x	190.00 x	— x	15.00 x	—
—	CH	165.00 x	206.00 x	— x	52.00 x	—	52348	U004	170.00 x	190.00 x	— x	15.00 x	—
58163	U001	165.00 x	208.00 x	— x	22.00 x	—	52348	U004	170.00 x	190.00 x	— x	15.00 x	—
58164	U002	165.00 x	208.00 x	— x	22.00 x	—	6428	CH	170.00 x	190.00 x	— x	30.00 x	—
3320	C	165.00 x	254.00 x	— x	25.40 x	—	3495	C	170.00 x	192.00 x	— x	7.20 x	—
—	C	165.00 x	318.00 x	40.00 x	6.00 x	—	3495	C	170.00 x	192.00 x	— x	31.00 x	—
58165	U006	165.10 x	173.04 x	— x	13.49 x	—	52426	U019	170.00 x	193.00 x	— x	16.00 x	—
—	U04A	165.10 x	177.80 x	— x	6.35 x	—	58189	U004	170.00 x	195.00 x	— x	15.00 x	—
—	U04A	165.10 x	177.80 x	— x	14.28 x	—	52401	U001	170.00 x	196.00 x	— x	15.00 x	—
—	U04A	165.10 x	184.20 x	— x	9.52 x	—	52426	U	170.00 x	196.00 x	— x	16.00 x	—
58077	U04A	165.10 x	184.20 x	— x	15.87 x	—	F15648	W	170.00 x	200.00 x	— x	13.50 x	—
58166	U004	165.10 x	185.74 x	— x	12.70 x	—	3147	C	170.00 x	200.00 x	7.00 x	15.00 x	—
58167	U004	165.10 x	187.33 x	— x	12.70 x	—	51572	U001	170.00 x	200.00 x	— x	15.00 x	—
8180	V	165.10 x	190.50 x	— x	10.00 x	—	51572	U001	170.00 x	200.00 x	— x	15.00 x	—
—	U04A	165.10 x	190.50 x	— x	12.70 x	—	58190	U002	170.00 x	200.00 x	— x	15.00 x	—
—	U04A	165.10 x	190.50 x	— x	19.05 x	—	50935	U005	170.00 x	200.00 x	— x	15.00 x	—
6146	CH	165.10 x	190.50 x	— x	31.75 x	—	58191	U019	170.00 x	200.00 x	— x	15.00 x	—
—	CH	165.10 x	196.85 x	— x	58.50 x	—	53020	U019	170.00 x	200.00 x	— x	16.00 x	—
58168	U019	165.10 x	203.20 x	— x	19.05 x	—	53020	U019	170.00 x	200.00 x	— x	16.00 x	—
58169	U004	165.20 x	183.00 x	— x	16.00 x	—	51576	U074	170.00 x	200.00 x	— x	20.00 x	—
50077	U004	166.00 x	175.00 x	— x	15.00 x	—	58192	U	170.00 x	200.00 x	— x	22.00 x	—
58170	U001	166.00 x	178.00 x	— x	6.00 x	—	51207	U004	170.00 x	200.00 x	— x	22.00 x	—
58171	U002	166.00 x	178.00 x	— x	6.00 x	—	50403	U004	170.00 x	200.00 x	— x	22.00 x	—
58172	U007	166.00 x	180.00 x	— x	15.50 x	—	51207	U004	170.00 x	200.00 x	— x	22.00 x	—
58173	U008	166.00 x	180.00 x	— x	15.50 x	—	50403	U004	170.00 x	200.00 x	— x	22.00 x	—
50758	U002	166.00 x	185.00 x	— x	12.00 x	10.50	50384	U056	170.00 x	200.00 x	— x	23.00 x	—
3264	C	166.00 x	200.00 x	— x	19.05 x	—	50384	U056	170.00 x	200.00 x	— x	23.00 x	—



Cód	Mod	Di x	De x	Esp. x	Ha1 x	Ha2	Cód	Mod	Di x	De x	Esp. x	Ha1 x	Ha2
58193	U001	170.00 x	200.00 x	— x	26.00 x	—	58226	U004	175.00 x	200.00 x	— x	15.00 x	—
58194	U002	170.00 x	200.00 x	— x	26.00 x	—	51380	U	175.00 x	202.00 x	— x	13.50 x	—
6245	CH	170.00 x	200.00 x	— x	34.50 x	—	55584	U002	175.00 x	205.00 x	— x	15.00 x	—
6417	CH	170.00 x	200.00 x	— x	125.00 x	—	58227	U002	175.00 x	205.00 x	— x	15.00 x	—
58195	U001	170.00 x	201.00 x	— x	26.00 x	—	58228	U002	175.00 x	205.00 x	— x	18.00 x	—
58196	U002	170.00 x	201.00 x	— x	26.00 x	—	—	CH	175.00 x	205.00 x	— x	66.50 x	—
51101	U003	170.00 x	202.00 x	— x	15.00 x	—	50203	U004	175.00 x	210.00 x	— x	22.00 x	—
58197	U001	170.00 x	209.00 x	— x	20.00 x	—	50203	U004	175.00 x	210.00 x	— x	22.00 x	—
58198	U002	170.00 x	209.00 x	— x	20.00 x	—	58229	U001	175.00 x	215.00 x	— x	20.00 x	—
8372	V	170.00 x	210.00 x	— x	11.00 x	—	58230	U002	175.00 x	215.00 x	— x	20.00 x	—
8115	V	170.00 x	210.00 x	— x	17.50 x	—	51161	U033	176.00 x	200.00 x	— x	12.00 x	—
58199	U001	170.00 x	210.00 x	— x	20.00 x	—	—	CH	176.00 x	205.00 x	— x	40.00 x	—
58200	U002	170.00 x	210.00 x	— x	20.00 x	—	50504	U021	176.01 x	206.37 x	— x	19.05 x	—
58201	U019	170.00 x	210.00 x	— x	20.00 x	—	50703	U002	176.21 x	198.44 x	— x	12.70 x	10.70
53257	U04A	170.00 x	210.00 x	— x	23.00 x	—	52567	U004	176.60 x	198.00 x	— x	15.00 x	—
6096	CH	170.00 x	210.00 x	— x	92.00 x	—	58231	U005	177.00 x	190.00 x	— x	8.50 x	—
58202	U001	170.00 x	215.00 x	— x	20.00 x	—	58232	U031	177.00 x	207.00 x	— x	15.00 x	—
58203	U002	170.00 x	215.00 x	— x	20.00 x	—	3339	C	177.00 x	214.00 x	3.00 x	13.00 x	—
3498	C	170.00 x	220.00 x	5.00 x	20.00 x	—	50532	U008	177.80 x	190.50 x	— x	7.14 x	—
51285	U031	170.80 x	215.50 x	— x	27.00 x	—	58233	U019	177.80 x	196.85 x	— x	15.88 x	—
58204	U001	171.00 x	179.00 x	— x	8.00 x	—	—	U04A	177.80 x	196.90 x	— x	9.52 x	—
58205	U002	171.00 x	179.00 x	— x	8.00 x	—	50811	U040	177.80 x	198.42 x	— x	14.29 x	—
58206	U005	171.00 x	179.00 x	— x	14.00 x	—	58234	U	177.80 x	200.02 x	— x	8.73 x	12.70
58207	U006	171.00 x	179.00 x	— x	14.00 x	—	50306	U103	177.80 x	200.02 x	— x	12.70 x	8.73
58208	U001	171.00 x	187.00 x	— x	12.00 x	—	F7228	W	177.80 x	201.61 x	— x	7.94 x	6.35
51916	U002	171.00 x	190.00 x	— x	20.00 x	—	51694	U04A	177.80 x	203.20 x	— x	12.00 x	—
58209	U005	171.00 x	195.00 x	— x	16.00 x	—	51694	U04A	177.80 x	203.20 x	— x	12.70 x	—
53216	U006	171.00 x	197.00 x	— x	12.00 x	—	50387	U065	177.80 x	203.20 x	— x	12.70 x	—
52665	U	171.00 x	203.00 x	— x	21.00 x	—	58235	U004	177.80 x	203.20 x	— x	15.08 x	—
58210	U001	171.00 x	211.50 x	— x	27.00 x	—	51925	U004	177.80 x	203.20 x	— x	18.00 x	—
53469	U04A	171.45 x	187.33 x	— x	7.94 x	—	52191	U	177.80 x	203.20 x	— x	19.05 x	—
—	CH	171.45 x	190.50 x	— x	37.00 x	—	6385	CH	177.80 x	203.20 x	— x	25.00 x	—
58211	U019	171.45 x	209.55 x	— x	19.05 x	—	—	CH	177.80 x	203.20 x	— x	50.00 x	—
8253	V	171.45 x	209.55 x	— x	41.27 x	—	58236	U001	177.80 x	207.96 x	— x	15.88 x	—
58212	U019	171.45 x	215.90 x	— x	19.05 x	—	—	CH	177.80 x	209.55 x	— x	68.00 x	—
—	U04A	171.50 x	184.20 x	— x	14.28 x	—	—	U04A	177.80 x	209.60 x	— x	15.87 x	10.00
—	U04A	171.50 x	190.50 x	— x	15.87 x	—	—	CH	177.80 x	215.90 x	— x	101.00 x	—
—	U04A	171.50 x	196.90 x	— x	19.05 x	—	58237	U007	178.00 x	190.00 x	— x	15.00 x	—
—	U04A	171.50 x	203.20 x	— x	25.40 x	—	58238	U008	178.00 x	190.00 x	— x	15.00 x	—
58213	U005	172.00 x	182.00 x	— x	13.50 x	—	58239	U005	178.00 x	191.00 x	— x	7.00 x	—
58214	U006	172.00 x	182.00 x	— x	13.50 x	—	58240	U031	178.00 x	201.00 x	— x	12.00 x	—
53416	U002	172.00 x	203.80 x	— x	18.00 x	—	58241	U002	178.00 x	203.40 x	— x	13.00 x	—
58215	U002	172.00 x	203.80 x	— x	18.00 x	—	58242	U002	178.00 x	203.40 x	— x	13.00 x	—
53078	U009	172.00 x	204.00 x	— x	15.00 x	—	51012	U031	178.00 x	207.00 x	— x	15.00 x	—
58216	U001	172.00 x	208.00 x	— x	16.00 x	—	58243	U001	178.00 x	208.00 x	— x	18.00 x	—
58217	U001	173.04 x	188.91 x	— x	9.53 x	—	58244	U002	178.00 x	208.00 x	— x	18.00 x	—
52778	U004	174.00 x	185.00 x	— x	15.00 x	13.00	58245	U001	178.00 x	218.00 x	— x	20.00 x	—
52778	U004	174.00 x	185.00 x	— x	15.00 x	—	58246	U002	178.00 x	218.00 x	— x	20.00 x	—
52778	U004	174.00 x	185.00 x	— x	15.00 x	13.00	F14214	ESPE	179.00 x	191.60 x	— x	2.50 x	0.50
58218	U007	174.00 x	185.00 x	— x	15.00 x	—	6133	CH	179.00 x	205.00 x	— x	36.00 x	—
58219	U008	174.00 x	185.00 x	— x	15.00 x	—	50614	U004	179.37 x	209.55 x	— x	22.22 x	—
58220	U002	174.00 x	188.00 x	— x	10.00 x	—	58247	U	179.39 x	209.55 x	— x	22.22 x	—
52896	U	174.00 x	206.00 x	— x	10.50 x	—	53406	U04A	179.50 x	197.00 x	— x	6.35 x	—
51476	U074	174.00 x	206.00 x	— x	20.00 x	—	52764	U031	179.50 x	203.20 x	— x	15.87 x	—
58221	U031	174.00 x	213.00 x	— x	15.00 x	—	58248	U031	179.50 x	203.20 x	— x	15.88 x	—
—	CH	174.00 x	219.00 x	— x	92.00 x	—	58249	U005	180.00 x	188.00 x	— x	14.00 x	—
—	CH	174.17 x	204.17 x	— x	55.00 x	—	58250	U006	180.00 x	188.00 x	— x	14.00 x	—
6384	CH	174.60 x	190.50 x	— x	31.00 x	—	51736	U047	180.00 x	197.00 x	— x	7.00 x	—
—	CH	174.63 x	190.50 x	— x	31.00 x	—	6425	CH	180.00 x	199.00 x	25.00 x	—	—
58222	U006	175.00 x	186.00 x	— x	15.00 x	—	58251	U001	180.00 x	200.00 x	— x	10.00 x	—
58223	U002	175.00 x	188.00 x	— x	7.00 x	—	58252	U002	180.00 x	200.00 x	— x	10.00 x	—
58224	U031	175.00 x	188.00 x	— x	8.00 x	—	8338	V	180.00 x	200.00 x	— x	10.00 x	—
53055	U002	175.00 x	189.00 x	— x	12.00 x	—	50123	U002	180.00 x	200.00 x	— x	11.00 x	—
51771	U002	175.00 x	200.00 x	— x	12.00 x	—	58253	U002	180.00 x	200.00 x	— x	12.00 x	—
51771	U002	175.00 x	200.00 x	— x	12.00 x	—	51707	U019	180.00 x	200.00 x	— x	12.50 x	10.00
8077	V	175.00 x	200.00 x	— x	12.00 x	—	50717	U002	180.00 x	200.00 x	— x	15.00 x	—
58225	U002	175.00 x	200.00 x	— x	15.00 x	—	50717	U002	180.00 x	200.00 x	— x	15.00 x	—





Cód	Mod	Di x	De x	Esp. x	Ha1 x	Ha2	Cód	Mod	Di x	De x	Esp. x	Ha1 x	Ha2
58254	U004	180.00 x	200.00 x	— x	15.00 x	—	58287	U003	184.15 x	203.20 x	— x	13.49 x	—
8238	V	180.00 x	200.00 x	— x	15.00 x	—	53218	U004	184.15 x	209.55 x	— x	12.70 x	—
50142	U077	180.00 x	200.00 x	— x	16.00 x	14.00	52261	U	184.15 x	215.90 x	— x	25.40 x	—
58255	U001	180.00 x	200.00 x	— x	18.00 x	—	58288	U019	184.15 x	222.25 x	— x	19.05 x	—
58256	U002	180.00 x	200.00 x	— x	18.00 x	—	—	U04A	184.20 x	200.00 x	— x	7.93 x	—
58257	U002	180.00 x	200.00 x	— x	18.00 x	—	—	U04A	184.20 x	203.20 x	— x	15.87 x	—
58258	U003	180.00 x	200.00 x	— x	25.00 x	—	58289	U001	184.20 x	215.90 x	— x	25.00 x	—
—	CH	180.00 x	200.00 x	— x	37.00 x	—	—	U04A	184.20 x	215.90 x	— x	25.40 x	—
52519	U013	180.00 x	201.30 x	— x	13.00 x	—	58290	U007	185.00 x	197.00 x	— x	6.50 x	—
58259	U019	180.00 x	203.00 x	— x	15.00 x	—	58291	U005	185.00 x	197.00 x	— x	15.00 x	—
58260	U001	180.00 x	204.00 x	— x	12.00 x	—	58292	U006	185.00 x	197.00 x	— x	15.00 x	—
58261	U002	180.00 x	204.00 x	— x	12.00 x	—	58293	U002	185.00 x	200.00 x	— x	7.00 x	—
F.....	J	180.00 x	204.00 x	— x	15.00 x	22.00	53285	U	185.00 x	200.00 x	— x	7.50 x	—
8325	V	180.00 x	205.00 x	— x	5.00 x	—	58294	U001	185.00 x	200.00 x	— x	7.50 x	—
6330	CH	180.00 x	205.00 x	— x	45.00 x	—	53285	U001	185.00 x	200.00 x	— x	7.50 x	—
—	CH	180.00 x	209.00 x	— x	59.50 x	—	58295	U001	185.00 x	200.00 x	— x	8.00 x	—
58262	U001	180.00 x	210.00 x	— x	15.00 x	—	58296	U008	185.00 x	200.00 x	— x	15.00 x	—
58263	U007	180.00 x	210.00 x	— x	15.00 x	—	6445	CH	185.00 x	200.00 x	— x	20.00 x	—
53473	U006	180.00 x	210.00 x	— x	16.00 x	—	51549	U	185.00 x	203.00 x	— x	10.00 x	—
53473	U006	180.00 x	210.00 x	— x	16.00 x	—	58297	U004	185.00 x	205.00 x	— x	15.00 x	—
52289	U	180.00 x	210.00 x	— x	17.00 x	—	58298	U006	185.00 x	205.00 x	— x	15.00 x	—
58264	U002	180.00 x	210.00 x	— x	17.00 x	—	53537	U004	185.00 x	206.00 x	— x	16.00 x	—
52289	U002	180.00 x	210.00 x	— x	17.50 x	—	50218	U019	185.00 x	209.00 x	— x	12.00 x	—
58265	U004	180.00 x	210.00 x	— x	18.00 x	—	53254	U04A	185.00 x	210.00 x	— x	20.00 x	—
58266	U004	180.00 x	210.00 x	— x	22.00 x	—	58299	U001	185.00 x	215.00 x	— x	15.00 x	—
58267	U001	180.00 x	210.00 x	— x	26.00 x	—	58300	U002	185.00 x	215.00 x	— x	15.00 x	—
58268	U002	180.00 x	210.00 x	— x	26.00 x	—	58301	U005	185.00 x	215.00 x	— x	25.00 x	—
—	CH	180.00 x	210.00 x	— x	59.00 x	—	—	CH	185.00 x	215.00 x	— x	66.50 x	—
6354	CH	180.00 x	210.00 x	— x	62.50 x	—	58302	U001	185.00 x	220.00 x	— x	20.00 x	—
—	CH	180.00 x	210.00 x	— x	64.00 x	—	58303	U002	185.00 x	220.00 x	— x	20.00 x	—
—	CH	180.00 x	210.00 x	— x	105.00 x	—	58304	U001	185.00 x	223.00 x	— x	24.00 x	—
55589	U04A	180.00 x	212.00 x	— x	16.00 x	—	51337	U	185.00 x	225.00 x	— x	20.00 x	—
3285	C	180.00 x	220.00 x	— x	14.00 x	—	58305	U002	185.00 x	225.00 x	— x	20.00 x	—
58269	U001	180.00 x	220.00 x	— x	20.00 x	—	3187	C	185.00 x	254.00 x	— x	22.00 x	—
58270	U002	180.00 x	220.00 x	— x	20.00 x	—	51819	U002	185.70 x	204.80 x	— x	9.52 x	—
58271	U003	180.00 x	220.00 x	— x	20.00 x	—	51842	U031	186.00 x	200.00 x	— x	10.30 x	—
58272	U019	180.00 x	220.00 x	— x	20.00 x	—	58306	U007	186.00 x	200.00 x	— x	15.50 x	—
58273	U001	180.00 x	230.00 x	— x	25.00 x	—	58307	U008	186.00 x	200.00 x	— x	15.50 x	—
58274	U002	180.00 x	230.00 x	— x	25.00 x	—	51026	U019	186.00 x	201.00 x	— x	7.50 x	—
51908	U029	180.00 x	260.00 x	— x	15.00 x	—	51747	U002	186.00 x	203.20 x	— x	8.00 x	—
50764	U002	180.20 x	215.50 x	— x	27.00 x	—	51975	U	186.00 x	240.00 x	— x	8.00 x	—
—	CH	180.98 x	212.73 x	— x	61.50 x	—	53391	U04A	187.00 x	200.00 x	— x	10.00 x	—
55709	U	181.00 x	204.00 x	— x	12.70 x	—	55723	U002	187.00 x	202.00 x	— x	8.00 x	—
53527	U004	181.50 x	197.00 x	— x	12.00 x	—	58308	U002	187.00 x	202.50 x	— x	8.00 x	—
53480	U04A	182.00 x	196.00 x	— x	16.70 x	—	58309	U002	187.00 x	203.40 x	— x	8.00 x	—
50258	U002	182.00 x	200.00 x	— x	22.00 x	—	52893	U	187.00 x	205.00 x	— x	10.00 x	—
58275	U002	182.00 x	203.00 x	— x	21.00 x	—	52893	U04A	187.00 x	205.00 x	— x	10.00 x	—
58276	U019	182.00 x	209.00 x	— x	16.00 x	—	8391	V	187.00 x	205.00 x	— x	10.00 x	—
52203	U004	182.00 x	212.00 x	— x	22.00 x	—	3173	C	187.00 x	254.00 x	4.00 x	30.00 x	—
—	CH	182.00 x	214.00 x	— x	103.00 x	—	52235	U002	187.30 x	203.20 x	— x	10.28 x	—
58277	U001	182.00 x	215.00 x	— x	15.00 x	—	52235	U002	187.30 x	203.20 x	— x	10.28 x	—
58278	U002	182.00 x	215.00 x	— x	15.00 x	—	3117	C	187.30 x	253.20 x	5.00 x	20.60 x	—
8138	V	182.00 x	232.00 x	— x	12.60 x	—	—	CH	187.33 x	212.73 x	— x	50.00 x	—
3284	C	182.00 x	280.00 x	5.00 x	24.00 x	—	58310	U019	187.33 x	225.43 x	— x	19.45 x	—
53203	U	182.56 x	196.80 x	— x	22.00 x	—	59283	U04A	188.00 x	200.00 x	— x	12.00 x	—
58279	U004	182.56 x	201.61 x	— x	22.23 x	—	58311	U004	188.00 x	202.00 x	— x	8.00 x	—
58280	U007	183.00 x	195.00 x	— x	15.00 x	—	58312	U004	188.00 x	210.00 x	— x	15.00 x	—
58281	U008	183.00 x	195.00 x	— x	15.00 x	—	58313	U004	188.00 x	210.00 x	— x	15.00 x	—
58282	U019	183.00 x	200.00 x	— x	23.00 x	—	58314	U001	188.00 x	228.00 x	— x	20.00 x	—
58283	U004	183.00 x	202.70 x	— x	22.00 x	—	58315	U002	188.00 x	228.00 x	— x	20.00 x	—
58284	U004	183.00 x	203.00 x	— x	12.00 x	—	58316	U002	188.12 x	201.61 x	— x	7.94 x	—
52477	U006	183.00 x	203.50 x	— x	22.60 x	22.00	53162	U002	188.12 x	203.00 x	— x	8.80 x	—
58285	U001	183.00 x	223.00 x	— x	20.00 x	—	53163	UA-2	188.70 x	220.50 x	— x	25.40 x	—
58286	U002	183.00 x	223.00 x	— x	20.00 x	—	58318	U002	189.00 x	201.00 x	— x	6.50 x	—
3095	C	184.00 x	228.00 x	4.00 x	15.00 x	—	58319	U007	190.00 x	199.50 x	— x	14.50 x	—
3471	C	184.00 x	291.50 x	5.30 x	24.00 x	—	58320	U002	190.00 x	200.00 x	— x	6.00 x	—
51338	U	184.15 x	203.20 x	— x	13.49 x	—	50826	U007	190.00 x	200.00 x	— x	6.00 x	—



Cód	Mod	Di x	De x	Esp. x	Ha1 x	Ha2	Cód	Mod	Di x	De x	Esp. x	Ha1 x	Ha2
58321	U007	190.00 x	200.00 x	— x	14.00 x	—	53300	U004	195.00 x	225.00 x	— x	16.50 x	—
58322	U008	190.00 x	200.00 x	— x	14.00 x	—	52688	U074	195.00 x	225.00 x	— x	18.00 x	4.00
58323	U001	190.00 x	201.00 x	— x	10.00 x	—	F8845	W	195.00 x	225.00 x	— x	18.00 x	—
58324	U005	190.00 x	202.00 x	— x	15.00 x	—	58360	U001	195.00 x	225.00 x	— x	26.00 x	—
58325	U006	190.00 x	202.00 x	— x	15.00 x	—	58361	U002	195.00 x	225.00 x	— x	26.00 x	—
58326	U002	190.00 x	203.00 x	— x	8.00 x	—	6262	CH	195.00 x	225.00 x	— x	54.00 x	—
58327	U001	190.00 x	210.00 x	— x	10.00 x	—	58362	U001	195.00 x	230.00 x	— x	20.00 x	—
53376	U004	190.00 x	210.00 x	— x	13.50 x	—	58363	U002	195.00 x	230.00 x	— x	20.00 x	—
50716	U	190.00 x	210.00 x	— x	15.00 x	—	58364	U001	195.00 x	235.00 x	— x	20.00 x	—
58328	U004	190.00 x	210.00 x	— x	15.00 x	—	58365	U002	195.00 x	235.00 x	— x	20.00 x	—
58329	U004	190.00 x	210.00 x	— x	15.00 x	—	58366	U019	195.00 x	235.00 x	— x	37.00 x	—
58330	U001	190.00 x	210.00 x	— x	20.00 x	—	58367	U001	195.00 x	240.00 x	— x	20.00 x	—
6279	CH	190.00 x	210.00 x	— x	40.00 x	—	58368	U002	195.00 x	240.00 x	— x	20.00 x	—
58331	U002	190.00 x	211.00 x	— x	13.00 x	—	52829	U021	195.00 x	247.70 x	— x	24.00 x	22.00
51289	U001	190.00 x	215.00 x	— x	17.00 x	—	52959	U	195.00 x	254.00 x	— x	3.18 x	—
59431	U087	190.00 x	216.00 x	— x	13.00 x	—	52396	U002	196.00 x	226.00 x	— x	13.00 x	12.00
58332	U002	190.00 x	220.00 x	— x	10.00 x	—	—	CH	196.00 x	226.00 x	— x	85.00 x	—
58333	U001	190.00 x	220.00 x	— x	15.00 x	—	58369	U001	196.00 x	228.00 x	— x	28.00 x	—
58334	U019	190.00 x	220.00 x	— x	15.00 x	—	58370	U001	196.00 x	232.00 x	— x	15.00 x	—
58341	U002	190.00 x	220.00 x	— x	16.00 x	—	58371	U002	196.00 x	232.00 x	— x	15.00 x	—
50724	U	190.00 x	220.00 x	— x	22.00 x	—	—	CH	196.00 x	232.00 x	— x	55.00 x	—
58335	U004	190.00 x	220.00 x	— x	22.00 x	—	52642	U001	196.85 x	209.50 x	— x	6.35 x	—
58336	U004	190.00 x	220.00 x	— x	22.00 x	—	—	CH	196.85 x	222.25 x	— x	41.50 x	—
58337	U001	190.00 x	220.00 x	— x	26.00 x	—	51903	U	196.85 x	228.60 x	— x	15.88 x	—
58338	U002	190.00 x	220.00 x	— x	26.00 x	—	58372	U019	196.85 x	234.95 x	— x	19.05 x	—
58339	U004	190.00 x	220.00 x	— x	28.00 x	—	58317	U04A	196.90 x	215.90 x	— x	15.87 x	—
58340	U004	190.00 x	220.00 x	— x	28.00 x	—	—	U04A	196.90 x	222.30 x	— x	12.70 x	—
55732	U04A	190.00 x	220.00 x	— x	28.00 x	—	—	U04A	196.90 x	222.30 x	— x	19.05 x	—
6371	CH	190.00 x	220.00 x	— x	32.50 x	—	53320	U04A	196.95 x	212.72 x	— x	14.00 x	—
—	CH	190.00 x	220.00 x	— x	98.00 x	—	58373	U001	197.00 x	212.00 x	— x	7.50 x	—
58342	U001	190.00 x	230.00 x	— x	20.00 x	—	58374	U002	197.00 x	212.00 x	— x	7.50 x	—
58343	U002	190.00 x	230.00 x	— x	20.00 x	—	58375	U004	197.00 x	212.00 x	— x	11.00 x	—
3552	C	190.00 x	293.00 x	— x	26.20 x	—	—	CH	197.00 x	217.00 x	— x	47.00 x	—
58344	U001	190.10 x	203.20 x	— x	9.53 x	—	52109	U003	197.00 x	225.00 x	— x	12.70 x	—
55707	U	190.50 x	203.20 x	— x	6.35 x	—	58376	U007	198.00 x	210.00 x	— x	15.00 x	—
52776	U	190.50 x	203.20 x	— x	14.29 x	—	58377	U008	198.00 x	210.00 x	— x	15.00 x	—
—	U04A	190.50 x	206.40 x	— x	7.93 x	—	58378	U004	198.00 x	223.00 x	— x	20.00 x	—
53448	U04A	190.50 x	209.55 x	— x	9.52 x	—	58379	U001	198.00 x	230.00 x	— x	25.00 x	—
—	U04A	190.50 x	209.60 x	— x	15.87 x	—	58380	U001	198.00 x	232.00 x	— x	15.00 x	—
8192	V	190.50 x	215.90 x	— x	10.92 x	—	58381	U002	198.00 x	232.00 x	— x	15.00 x	—
—	U04A	190.50 x	215.90 x	— x	19.05 x	—	58382	U001	198.00 x	250.00 x	— x	25.00 x	—
8131	V	190.50 x	215.90 x	— x	19.45 x	—	58383	U002	198.00 x	250.00 x	— x	25.00 x	—
—	CH	190.50 x	215.90 x	— x	42.50 x	—	52351	U019	198.50 x	229.50 x	— x	20.00 x	—
6057	CH	190.50 x	222.30 x	— x	60.33 x	—	58384	U002	198.50 x	230.00 x	— x	25.00 x	—
6082	CH	190.50 x	222.36 x	— x	60.33 x	—	55656	U	199.00 x	220.00 x	— x	8.10 x	—
8287	V	190.50 x	223.00 x	— x	11.50 x	—	58385	U001	199.00 x	221.00 x	— x	12.00 x	—
58345	U019	190.50 x	228.60 x	— x	19.05 x	—	58386	U005	200.00 x	212.00 x	— x	15.00 x	—
58346	U001	191.00 x	215.00 x	— x	15.00 x	—	58387	U006	200.00 x	212.00 x	— x	15.00 x	—
58347	U019	191.50 x	215.00 x	— x	14.00 x	—	—	CH	200.00 x	214.00 x	— x	37.50 x	—
58348	U006	192.00 x	200.50 x	— x	14.00 x	—	59256	U04A	200.00 x	215.00 x	— x	17.00 x	—
55565	U005	192.00 x	201.00 x	— x	8.00 x	—	58388	U001	200.00 x	220.00 x	— x	10.00 x	—
58349	U005	192.50 x	200.50 x	— x	14.00 x	—	58389	U007	200.00 x	220.00 x	— x	14.00 x	—
58350	U005	192.50 x	200.50 x	— x	14.00 x	—	58390	U007	200.00 x	220.00 x	— x	14.00 x	—
55698	U	193.50 x	226.60 x	— x	17.00 x	—	51276	U	200.00 x	220.00 x	— x	15.00 x	—
—	CH	193.68 x	219.08 x	— x	50.50 x	—	58391	U002	200.00 x	220.00 x	— x	15.00 x	—
58351	U007	194.00 x	205.00 x	— x	15.00 x	—	58392	U001	200.00 x	220.00 x	— x	18.00 x	—
58352	U008	194.00 x	205.00 x	— x	15.00 x	—	58393	U002	200.00 x	220.00 x	— x	18.00 x	—
58353	U001	194.00 x	218.00 x	— x	12.00 x	—	58394	U007	200.00 x	222.00 x	— x	14.00 x	—
58354	U001	194.00 x	218.00 x	— x	12.00 x	—	51035	U	200.00 x	225.00 x	— x	12.50 x	—
—	CH	194.00 x	225.00 x	— x	50.00 x	—	58395	U006	200.00 x	225.00 x	— x	13.00 x	—
55676	U	194.32 x	209.30 x	— x	8.20 x	—	58396	U001	200.00 x	225.00 x	— x	15.00 x	—
58355	U007	195.00 x	206.00 x	— x	15.00 x	—	58397	U002	200.00 x	225.00 x	— x	15.00 x	—
58356	U008	195.00 x	206.00 x	— x	15.00 x	—	55743	U	200.00 x	225.00 x	— x	19.00 x	—
58357	U001	195.00 x	225.00 x	— x	15.00 x	—	58398	U001	200.00 x	230.00 x	— x	15.00 x	—
58358	U002	195.00 x	225.00 x	— x	15.00 x	—	58397	U002	200.00 x	230.00 x	— x	15.00 x	—
58359	U019	195.00 x	225.00 x	— x	15.00 x	—	58398	U019	200.00 x	230.00 x	— x	15.00 x	—
51294	U002	195.00 x	225.00 x	— x	16.00 x	5.00	58399	U004	200.00 x	230.00 x	— x	17.00 x	—



Cód	Mod	Di x	De x	Esp. x	Ha1 x	Ha2	Cód	Mod	Di x	De x	Esp. x	Ha1 x	Ha2
53532	U004	200.00 x	230.00 x	— x	17.00 x	—	58430	U005	205.00 x	215.00 x	— x	13.50 x	—
53532	U004	200.00 x	230.00 x	— x	17.00 x	—	58431	U006	205.00 x	215.00 x	— x	13.50 x	—
58400	U004	200.00 x	230.00 x	— x	18.00 x	—	58432	U001	205.00 x	230.00 x	— x	15.00 x	—
55654	U04A	200.00 x	230.00 x	— x	18.50 x	—	58433	U002	205.00 x	230.00 x	— x	15.00 x	—
58401	U001	200.00 x	230.00 x	— x	22.00 x	—	58434	U001	205.00 x	230.00 x	— x	20.00 x	—
58402	U004	200.00 x	230.00 x	— x	22.00 x	—	58435	U002	205.00 x	230.00 x	— x	20.00 x	—
58403	U001	200.00 x	230.00 x	— x	26.00 x	—	58436	U001	205.00 x	235.00 x	— x	15.00 x	—
58404	U002	200.00 x	230.00 x	— x	26.00 x	—	58437	U002	205.00 x	235.00 x	— x	15.00 x	—
—	CH	200.00 x	230.00 x	— x	65.00 x	—	58438	U004	205.00 x	235.00 x	— x	18.00 x	—
6439	CH	200.00 x	230.00 x	— x	80.00 x	—	—	CH	205.00 x	235.00 x	— x	65.50 x	—
6440	CH	200.00 x	230.00 x	— x	80.00 x	—	58439	U001	205.00 x	245.00 x	— x	20.00 x	—
58405	U001	200.00 x	232.00 x	— x	15.00 x	—	58440	U002	205.00 x	245.00 x	— x	20.00 x	—
58406	U002	200.00 x	232.00 x	— x	15.00 x	—	—	U04A	206.37 x	231.77 x	— x	14.27 x	—
—	CH	200.00 x	232.00 x	— x	59.50 x	—	58441	U004	206.50 x	235.00 x	— x	22.00 x	—
52548	U	200.00 x	236.00 x	— x	25.00 x	—	51530	U002	207.00 x	228.60 x	— x	12.70 x	—
58407	U002	200.00 x	240.00 x	— x	20.00 x	—	58442	U001	208.00 x	223.00 x	— x	12.00 x	—
53231	U004	200.00 x	240.00 x	— x	20.00 x	—	58443	U002	208.00 x	223.00 x	— x	12.00 x	—
58408	U019	200.00 x	240.00 x	— x	20.00 x	—	3515	C	208.00 x	224.00 x	— x	10.00 x	—
58409	U001	200.00 x	240.00 x	— x	22.00 x	—	58444	U001	208.00 x	240.00 x	— x	20.00 x	—
58410	U002	200.00 x	240.00 x	— x	22.00 x	—	58445	U002	208.00 x	240.00 x	— x	20.00 x	—
58411	U001	200.00 x	240.00 x	— x	30.00 x	—	3286	C	208.00 x	250.00 x	— x	20.00 x	—
58412	U002	200.00 x	240.00 x	— x	30.00 x	—	58446	U007	209.00 x	220.00 x	— x	12.50 x	—
58413	U001	200.00 x	240.00 x	— x	34.00 x	—	58447	U008	209.00 x	220.00 x	— x	12.50 x	—
58414	U002	200.00 x	240.00 x	— x	34.00 x	—	53501	U04A	209.00 x	228.00 x	— x	12.50 x	—
—	CH	200.00 x	240.00 x	— x	92.00 x	—	—	CH	209.00 x	247.95 x	— x	65.00 x	—
58415	U007	201.00 x	215.00 x	— x	15.00 x	—	58448	U003	209.00 x	253.00 x	— x	25.00 x	—
58416	U008	201.00 x	215.00 x	— x	15.00 x	—	58449	U019	209.50 x	258.50 x	— x	19.00 x	—
8147	V	201.00 x	232.00 x	— x	12.50 x	—	58450	U003	209.55 x	228.60 x	— x	12.70 x	—
8147	V	201.00 x	232.00 x	— x	12.50 x	—	58451	U019	209.55 x	241.30 x	— x	12.70 x	—
3098	C	201.61 x	252.41 x	4.00 x	19.05 x	—	58452	U002	209.55 x	244.48 x	— x	22.23 x	—
58417	U019	202.00 x	220.00 x	— x	9.50 x	—	—	U04A	209.60 x	228.60 x	— x	9.52 x	—
58418	U001	202.00 x	222.00 x	— x	10.00 x	—	—	U04A	209.60 x	241.30 x	— x	25.40 x	—
58419	U002	202.00 x	222.00 x	— x	10.00 x	—	58453	U007	210.00 x	220.00 x	— x	12.00 x	—
—	CH	202.00 x	224.00 x	— x	37.00 x	—	58454	U008	210.00 x	220.00 x	— x	12.00 x	—
55749	U04A	202.00 x	226.00 x	— x	11.00 x	—	58455	U001	210.00 x	230.00 x	— x	10.00 x	—
58420	U005	202.00 x	236.00 x	— x	38.00 x	—	58456	U002	210.00 x	230.00 x	— x	10.00 x	—
58421	U003	202.00 x	243.00 x	— x	24.00 x	—	55682	U006	210.00 x	230.00 x	— x	15.00 x	—
58422	U001	203.00 x	218.00 x	— x	12.00 x	—	58457	U004	210.00 x	235.00 x	— x	18.00 x	—
58423	U002	203.00 x	218.00 x	— x	12.00 x	—	58458	U005	210.00 x	235.00 x	— x	24.50 x	—
59233	U04A	203.00 x	221.00 x	— x	10.00 x	—	58459	U006	210.00 x	235.00 x	— x	24.50 x	—
59233	U04A	203.00 x	221.00 x	— x	10.00 x	—	6338	CH	210.00 x	235.00 x	— x	39.50 x	—
58424	U019	203.00 x	233.00 x	— x	24.00 x	—	58460	U004	210.00 x	239.00 x	— x	22.00 x	—
6086	CH	203.20 x	215.90 x	— x	28.57 x	—	58461	U004	210.00 x	239.00 x	— x	22.50 x	—
—	CH	203.20 x	215.90 x	— x	32.50 x	—	58462	U004	210.00 x	240.00 x	— x	18.00 x	—
51087	U04A	203.20 x	222.25 x	— x	9.52 x	—	58463	U001	210.00 x	240.00 x	— x	20.00 x	—
51087	U04A	203.20 x	222.25 x	— x	9.52 x	—	58464	U002	210.00 x	240.00 x	— x	20.00 x	—
51820	U002	203.20 x	222.30 x	— x	9.50 x	—	6276	CH	210.00 x	240.00 x	— x	25.00 x	—
51820	U002	203.20 x	222.30 x	— x	9.52 x	—	—	CH	210.00 x	240.00 x	— x	72.00 x	—
—	U04A	203.20 x	228.60 x	— x	12.70 x	—	58465	U001	210.00 x	245.00 x	— x	20.00 x	—
58425	U004	203.20 x	228.60 x	— x	18.00 x	—	58466	U002	210.00 x	245.00 x	— x	20.00 x	—
—	U04A	203.20 x	228.60 x	— x	19.05 x	—	3179	C	210.00 x	250.00 x	4.00 x	20.00 x	—
—	CH	203.20 x	228.60 x	— x	47.00 x	—	58467	U001	210.00 x	250.00 x	— x	20.00 x	—
8346	V	203.20 x	234.95 x	— x	13.49 x	—	58468	U002	210.00 x	250.00 x	— x	20.00 x	—
—	CH	203.20 x	234.95 x	— x	53.00 x	—	58469	U019	210.00 x	250.00 x	— x	20.00 x	—
—	CH	203.20 x	234.95 x	— x	62.71 x	—	58470	U001	210.00 x	250.00 x	— x	21.00 x	—
—	CH	203.20 x	234.95 x	— x	181.00 x	—	58471	U001	210.00 x	250.00 x	— x	34.00 x	—
—	U04A	203.20 x	235.00 x	— x	25.40 x	—	58472	U002	210.00 x	250.00 x	— x	34.00 x	—
—	U04A	203.20 x	235.00 x	— x	25.40 x	—	53395	U04A	210.00 x	254.00 x	— x	29.00 x	—
6286	CH	203.20 x	235.00 x	— x	47.00 x	—	58473	U001	210.00 x	260.00 x	— x	25.00 x	—
8193	V	203.20 x	240.00 x	— x	15.50 x	—	58474	U002	210.00 x	260.00 x	— x	25.00 x	—
6163	CH	203.20 x	240.00 x	— x	39.00 x	—	3355	C	210.00 x	270.00 x	2.50 x	7.00 x	—
52549	U029	203.20 x	241.30 x	— x	16.40 x	—	58475	U002	210.00 x	270.00 x	— x	31.00 x	—
52550	U029	203.20 x	241.30 x	— x	16.40 x	—	58476	U003	210.00 x	300.00 x	— x	15.00 x	—
58427	U019	203.20 x	247.65 x	— x	19.05 x	—	58477	U007	211.00 x	225.00 x	— x	15.00 x	—
58428	U004	203.50 x	225.00 x	— x	17.00 x	—	58478	U008	211.00 x	225.00 x	— x	15.00 x	—
58429	U004	203.50 x	227.50 x	— x	19.00 x	—	58479	U001	212.00 x	268.00 x	— x	28.00 x	—
52611	U019	203.80 x	234.30 x	— x	16.30 x	—	58480	U002	212.00 x	268.00 x	— x	28.00 x	—



Cód	Mod	Di x	De x	Esp. x	Ha1 x	Ha2	Cód	Mod	Di x	De x	Esp. x	Ha1 x	Ha2
6231	CH	213.00 x	248.00 x	— x	43.60 x	—	58516	U004	220.00 x	255.00 x	— x	22.00 x	—
—	V	214.00 x	250.00 x	— x	16.00 x	—	59455	U	220.00 x	260.00 x	— x	16.00 x	—
—	CH	214.31 x	239.71 x	— x	58.00 x	—	58517	U001	220.00 x	260.00 x	— x	20.00 x	—
58481	U005	215.00 x	223.00 x	— x	12.00 x	—	58518	U019	220.00 x	260.00 x	— x	20.00 x	—
58482	U006	215.00 x	223.00 x	— x	12.00 x	—	58519	U002	220.00 x	260.00 x	— x	26.00 x	—
50988	U024	215.00 x	224.00 x	— x	13.80 x	—	58520	U001	220.00 x	260.00 x	— x	34.00 x	—
58483	U001	215.00 x	230.00 x	— x	7.50 x	—	58521	U002	220.00 x	260.00 x	— x	34.00 x	—
58484	U002	215.00 x	230.00 x	— x	7.50 x	—	58522	U001	220.00 x	265.00 x	— x	22.00 x	—
53056	U04A	215.00 x	230.00 x	— x	8.50 x	—	58523	U002	220.00 x	265.00 x	— x	22.00 x	—
58485	U001	215.00 x	230.00 x	— x	15.00 x	—	—	CH	220.00 x	270.00 x	— x	101.00 x	—
58486	U002	215.00 x	230.00 x	— x	15.00 x	—	55566	U001	220.00 x	372.00 x	— x	30.00 x	—
58487	U005	215.00 x	235.50 x	— x	13.00 x	—	58524	U007	221.00 x	235.00 x	— x	15.00 x	—
58488	U001	215.00 x	240.00 x	— x	12.00 x	—	58525	U008	221.00 x	235.00 x	— x	15.00 x	—
58489	U002	215.00 x	240.00 x	— x	12.00 x	—	3197	C	222.00 x	252.00 x	4.00 x	22.00 x	—
58490	U004	215.00 x	245.00 x	— x	18.00 x	—	58526	U	222.00 x	254.00 x	— x	20.00 x	21.00
—	CH	215.00 x	245.00 x	— x	73.50 x	—	50619	U002	222.00 x	254.00 x	— x	21.00 x	20.00
—	CH	215.00 x	247.00 x	— x	61.00 x	—	58527	U002	222.00 x	257.00 x	— x	18.00 x	—
53093	U019	215.00 x	254.00 x	— x	19.00 x	—	55611	U	222.20 x	251.20 x	— x	22.00 x	—
53248	U0A4	215.00 x	255.00 x	— x	24.00 x	—	—	CH	222.25 x	260.35 x	— x	72.00 x	—
—	CH	215.00 x	255.00 x	— x	84.00 x	—	—	U04A	222.30 x	247.70 x	— x	12.70 x	—
—	CH	215.90 x	234.95 x	— x	45.00 x	—	—	U04A	222.30 x	254.00 x	— x	25.40 x	—
—	CH	215.90 x	234.95 x	— x	80.00 x	—	6058	CH	222.30 x	254.00 x	— x	50.80 x	—
—	U04A	215.90 x	241.30 x	— x	19.05 x	—	58528	U004	223.00 x	248.00 x	— x	20.00 x	—
—	CH	215.90 x	241.30 x	— x	73.50 x	—	58529	U002	223.00 x	249.00 x	— x	12.50 x	—
58491	U019	215.90 x	252.41 x	— x	19.05 x	—	58530	U001	223.00 x	252.00 x	— x	14.00 x	—
58492	U019	215.90 x	254.00 x	— x	19.05 x	—	51933	U002	223.00 x	254.00 x	— x	23.00 x	—
F580	J	215.90 x	257.20 x	— x	34.93 x	—	58531	U005	224.00 x	254.00 x	— x	15.50 x	—
58493	U007	216.00 x	230.00 x	— x	15.00 x	—	58532	U001	224.00 x	260.00 x	— x	30.00 x	—
58494	U008	216.00 x	230.00 x	— x	15.00 x	—	58533	U002	224.00 x	260.00 x	— x	30.00 x	—
58495	U001	216.00 x	250.00 x	— x	15.00 x	—	58534	U004	224.00 x	265.00 x	— x	22.00 x	—
58496	U002	216.00 x	250.00 x	— x	15.00 x	—	53278	U002	224.50 x	293.50 x	— x	12.00 x	15.00
58497	U019	216.00 x	252.00 x	— x	19.00 x	—	58535	U004	225.00 x	245.00 x	— x	15.00 x	—
50129	U004	217.00 x	230.00 x	— x	15.00 x	—	51213	U002	225.00 x	247.00 x	— x	11.00 x	12.00
58498	U031	217.20 x	254.00 x	— x	17.50 x	—	58536	U001	225.00 x	250.00 x	— x	18.00 x	—
58499	U001	218.00 x	250.00 x	— x	15.00 x	—	58537	U004	225.00 x	250.00 x	— x	18.00 x	—
58500	U002	218.00 x	250.00 x	— x	15.00 x	—	58538	U001	225.00 x	250.00 x	— x	20.00 x	—
50776	U003	219.00 x	260.00 x	— x	23.00 x	—	58539	U002	225.00 x	250.00 x	— x	20.00 x	—
58501	U002	220.00 x	235.00 x	— x	10.00 x	—	6288	CH	225.00 x	250.00 x	— x	45.50 x	—
58502	U002	220.00 x	235.00 x	— x	13.00 x	—	58540	U002	225.00 x	255.00 x	— x	15.00 x	—
58503	U007	220.00 x	245.00 x	— x	24.00 x	—	58541	U001	225.00 x	255.00 x	— x	26.00 x	—
58504	U008	220.00 x	245.00 x	— x	24.00 x	—	58542	U002	225.00 x	255.00 x	— x	26.00 x	—
58505	U005	220.00 x	246.00 x	— x	24.50 x	—	—	CH	225.00 x	255.00 x	— x	107.00 x	—
58506	U006	220.00 x	246.00 x	— x	24.50 x	—	58543	U001	225.00 x	260.00 x	— x	30.00 x	—
53484	U	220.00 x	247.00 x	— x	21.30 x	—	58544	U002	225.00 x	260.00 x	— x	30.00 x	—
F8303	U	220.00 x	250.00 x	— x	15.00 x	—	58545	U002	225.00 x	265.00 x	— x	34.00 x	—
58508	U002	220.00 x	250.00 x	— x	15.00 x	—	58546	U001	225.00 x	275.00 x	— x	25.00 x	—
50571	U003	220.00 x	250.00 x	— x	15.00 x	—	58547	U002	225.00 x	275.00 x	— x	25.00 x	—
58507	U003	220.00 x	250.00 x	— x	15.00 x	—	58548	U007	226.00 x	240.00 x	— x	15.00 x	—
8023	V	220.00 x	250.00 x	— x	15.00 x	—	58549	U008	226.00 x	240.00 x	— x	15.00 x	—
51996	U002	220.00 x	250.00 x	— x	18.00 x	—	51214	U002	226.00 x	250.00 x	— x	12.00 x	9.00
51996	U002	220.00 x	250.00 x	— x	18.00 x	—	58550	U007	226.00 x	250.00 x	— x	16.00 x	—
51996	U002	220.00 x	250.00 x	— x	18.00 x	—	58551	U002	226.80 x	254.00 x	— x	12.70 x	—
58509	U004	220.00 x	250.00 x	— x	18.00 x	—	51152	U002	227.00 x	250.00 x	— x	11.50 x	12.50
58510	U019	220.00 x	250.00 x	— x	18.00 x	—	8256	V	227.00 x	252.00 x	— x	9.00 x	—
58511	U001	220.00 x	250.00 x	— x	20.00 x	—	—	CH	227.00 x	252.00 x	— x	45.00 x	—
58512	U002	220.00 x	250.00 x	— x	20.00 x	—	52106	U	227.00 x	305.00 x	— x	12.70 x	—
51870	U002	220.00 x	250.00 x	— x	21.00 x	—	51292	U	227.81 x	304.80 x	— x	12.70 x	—
51870	U004	220.00 x	250.00 x	— x	21.00 x	—	53501	U04A	228.00 x	209.00 x	— x	12.50 x	—
53474	U004	220.00 x	250.00 x	— x	22.00 x	—	—	CH	228.00 x	247.65 x	— x	36.50 x	—
58513	U004	220.00 x	250.00 x	— x	22.00 x	—	58552	U004	228.00 x	251.50 x	— x	18.30 x	—
52618	U056	220.00 x	250.00 x	— x	22.00 x	—	58553	U002	228.00 x	254.00 x	— x	12.00 x	—
50433	U019	220.00 x	250.00 x	— x	25.00 x	—	—	CH	228.00 x	254.00 x	— x	38.00 x	—
50433	U019	220.00 x	250.00 x	— x	25.00 x	—	52299	U	228.00 x	256.00 x	— x	19.00 x	6.00
58514	U001	220.00 x	250.00 x	— x	26.00 x	—	52299	U04A	228.00 x	256.00 x	— x	19.00 x	6.00
58515	U002	220.00 x	250.00 x	— x	26.00 x	—	51811	U041	228.00 x	277.00 x	— x	22.00 x	—
6178	CH	220.00 x	250.00 x	— x	38.00 x	—	58554	U002	228.60 x	254.00 x	— x	12.00 x	—
6247	CH	220.00 x	250.00 x	— x	51.00 x	—	—	U04A	228.60 x	254.00 x	— x	12.70 x	—





Cód	Mod	Di x	De x	Esp. x	Ha1 x	Ha2	Cód	Mod	Di x	De x	Esp. x	Ha1 x	Ha2
9045	W	228.60 x	254.00 x	— x	18.40 x	—	52016	U	235.00 x	263.00 x	— x	19.00 x	—
—	U04A	228.60 x	254.00 x	— x	19.05 x	—	—	CH	235.00 x	265.00 x	— x	66.50 x	—
—	CH	228.60 x	257.18 x	— x	45.00 x	—	—	CH	235.00 x	267.00 x	— x	54.00 x	—
58555	U002	228.60 x	258.80 x	— x	15.10 x	—	58591	U001	235.00 x	275.00 x	— x	20.00 x	—
—	CH	228.60 x	260.35 x	— x	63.00 x	—	58592	U002	235.00 x	275.00 x	— x	20.00 x	—
—	U04A	228.60 x	260.40 x	— x	25.40 x	—	58593	U019	235.00 x	275.00 x	— x	20.00 x	—
51696	U001	228.60 x	265.10 x	— x	22.20 x	—	8139	V	235.00 x	322.00 x	— x	15.87 x	—
58556	U019	228.60 x	266.70 x	— x	22.23 x	—	58594	U002	235.30 x	253.40 x	— x	10.50 x	—
58557	U002	229.00 x	241.00 x	— x	6.50 x	—	50267	U031	236.00 x	254.00 x	— x	10.00 x	—
55657	U	229.00 x	250.00 x	— x	8.10 x	—	58595	U004	236.00 x	257.00 x	— x	16.00 x	—
58558	U001	229.00 x	263.00 x	— x	20.00 x	—	58596	U004	237.50 x	249.50 x	— x	15.40 x	—
58559	U002	229.00 x	263.00 x	— x	20.00 x	—	51579	U031	237.60 x	254.00 x	— x	8.89 x	—
8414	V	229.00 x	267.00 x	— x	16.00 x	—	58597	U007	238.00 x	250.00 x	— x	14.00 x	—
—	CH	229.00 x	267.00 x	— x	69.00 x	—	58598	U008	238.00 x	250.00 x	— x	14.00 x	—
—	CH	229.00 x	267.00 x	— x	95.50 x	—	58599	U	238.00 x	254.00 x	— x	9.00 x	—
52265	U002	229.60 x	254.00 x	— x	12.70 x	—	3334	C	238.00 x	304.00 x	— x	19.00 x	—
58560	U002	230.00 x	240.00 x	— x	10.00 x	—	3334	C	238.00 x	304.00 x	8.00 x	19.00 x	—
58561	U005	230.00 x	242.00 x	— x	11.00 x	—	3157	C	238.00 x	310.00 x	— x	19.00 x	—
58562	U006	230.00 x	242.00 x	— x	11.00 x	—	3157	C	238.00 x	310.00 x	— x	19.00 x	—
58563	U001	230.00 x	246.00 x	— x	8.00 x	—	51997	U002	240.00 x	254.00 x	— x	9.00 x	—
50485	U004	230.00 x	248.00 x	— x	12.50 x	—	58600	U004	240.00 x	260.00 x	— x	17.00 x	—
55704	U004	230.00 x	249.00 x	— x	16.00 x	—	52239	U	240.00 x	265.00 x	— x	20.00 x	—
50639	U019	230.00 x	250.00 x	— x	9.50 x	—	—	CH	240.00 x	265.40 x	— x	60.00 x	—
50793	U002	230.00 x	250.00 x	— x	10.00 x	—	58601	U004	240.00 x	268.00 x	— x	18.00 x	—
58564	U004	230.00 x	250.00 x	— x	12.00 x	—	8177	V	240.00 x	270.00 x	— x	15.00 x	—
58565	U007	230.00 x	250.00 x	— x	12.00 x	—	8177	V	240.00 x	270.00 x	— x	15.00 x	—
58566	U004	230.00 x	250.00 x	— x	15.00 x	—	51700	U001	240.00 x	270.00 x	— x	16.00 x	—
55655	U04A	230.00 x	251.00 x	— x	8.10 x	—	58602	U004	240.00 x	270.00 x	— x	18.00 x	—
52543	U	230.00 x	254.00 x	— x	20.00 x	—	—	CH	240.00 x	270.00 x	— x	81.50 x	—
58567	U001	230.00 x	254.00 x	— x	20.00 x	—	58603	U001	240.00 x	272.00 x	— x	16.00 x	—
51182	U032	230.00 x	254.00 x	— x	85.00 x	—	58604	U002	240.00 x	272.00 x	— x	16.00 x	—
51182	U032	230.00 x	254.00 x	— x	85.00 x	—	58605	U001	240.00 x	272.00 x	— x	26.00 x	—
58568	U001	230.00 x	255.00 x	— x	15.00 x	—	58606	U002	240.00 x	272.00 x	— x	26.00 x	—
58569	U002	230.00 x	255.00 x	— x	15.00 x	—	58607	U001	240.00 x	280.00 x	— x	20.00 x	—
52379	U002	230.00 x	256.00 x	— x	12.70 x	—	58608	U002	240.00 x	280.00 x	— x	20.00 x	—
58570	U005	230.00 x	256.00 x	— x	24.50 x	—	58609	U003	240.00 x	280.00 x	— x	20.00 x	—
58571	U006	230.00 x	256.00 x	— x	24.50 x	—	58610	U019	240.00 x	280.00 x	— x	20.00 x	—
53472	U006	230.00 x	260.00 x	— x	15.00 x	—	51414	U003	240.00 x	280.00 x	— x	35.00 x	—
53472	U006	230.00 x	260.00 x	— x	15.00 x	—	50448	U096	240.00 x	286.00 x	— x	17.00 x	—
58572	U004	230.00 x	260.00 x	— x	22.00 x	—	58611	U001	240.00 x	290.00 x	— x	18.00 x	—
—	CH	230.00 x	260.00 x	— x	90.00 x	—	58612	U002	240.00 x	290.00 x	— x	18.00 x	—
55588	U04A	230.00 x	262.00 x	— x	15.00 x	—	58613	U001	240.00 x	305.00 x	— x	25.00 x	—
58573	U001	230.00 x	270.00 x	— x	20.00 x	—	58614	U002	240.00 x	305.00 x	— x	25.00 x	—
58574	U002	230.00 x	270.00 x	— x	20.00 x	—	58615	U002	241.00 x	280.00 x	— x	30.00 x	—
58575	U019	230.00 x	270.00 x	— x	20.00 x	—	—	U04A	241.30 x	266.70 x	— x	12.70 x	—
58576	U001	230.00 x	275.00 x	— x	22.00 x	—	58616	U019	241.30 x	279.40 x	— x	22.23 x	—
58577	U002	230.00 x	275.00 x	— x	22.00 x	—	51554	U04A	241.30 x	292.10 x	— x	25.40 x	—
51993	U051	230.00 x	305.00 x	— x	12.70 x	—	58617	U003	241.60 x	304.80 x	— x	33.34 x	—
50230	U004	231.00 x	250.00 x	— x	16.00 x	—	52282	U004	243.00 x	269.00 x	— x	20.00 x	—
58578	U001	232.00 x	252.00 x	— x	10.00 x	—	51136	U	243.00 x	283.00 x	— x	35.50 x	—
58579	U002	232.00 x	252.00 x	— x	10.00 x	—	58618	U004	245.00 x	265.00 x	— x	15.00 x	—
58580	U002	232.00 x	258.50 x	— x	12.00 x	—	—	CH	245.00 x	275.00 x	— x	66.50 x	—
52817	U	232.00 x	270.00 x	— x	20.00 x	—	58619	U001	245.00 x	285.00 x	— x	20.00 x	—
58581	U001	232.00 x	272.00 x	— x	34.00 x	—	58620	U002	245.00 x	285.00 x	— x	20.00 x	—
58582	U002	232.00 x	272.00 x	— x	34.00 x	—	58621	U001	245.00 x	295.00 x	— x	25.00 x	—
3254	C	232.50 x	263.00 x	— x	17.00 x	—	58622	U002	245.00 x	295.00 x	— x	25.00 x	—
58583	U001	233.00 x	245.00 x	— x	6.00 x	—	51501	U037	245.00 x	300.00 x	— x	38.00 x	32.00
58584	U002	233.00 x	245.00 x	— x	6.00 x	—	52283	U	247.00 x	269.00 x	— x	17.00 x	—
58585	U002	234.00 x	254.00 x	— x	15.50 x	—	52283	U004	247.00 x	269.00 x	— x	17.00 x	—
58586	U001	234.00 x	280.00 x	— x	25.00 x	—	58623	U001	247.00 x	280.00 x	— x	26.00 x	—
58587	U002	234.00 x	280.00 x	— x	25.00 x	—	58624	U002	247.00 x	280.00 x	— x	26.00 x	—
6252	CH	234.70 x	252.70 x	— x	34.00 x	—	58625	U001	247.00 x	289.00 x	— x	20.00 x	—
58588	U002	234.95 x	250.83 x	— x	8.73 x	—	—	CH	247.65 x	266.70 x	— x	36.50 x	—
58589	U003	234.95 x	254.00 x	— x	9.53 x	—	6151	CH	247.65 x	279.40 x	— x	46.80 x	—
—	CH	234.95 x	273.05 x	— x	59.00 x	—	53116	U	247.65 x	285.75 x	— x	31.75 x	—
—	U04A	235.00 x	250.80 x	— x	15.87 x	—	58626	U003	247.65 x	285.75 x	— x	38.10 x	—
58590	U006	235.00 x	255.00 x	— x	15.00 x	—	—	U04A	247.70 x	260.40 x	— x	14.28 x	—



Cód	Mod	Di x	De x	Esp. x	Ha1 x	Ha2	Cód	Mod	Di x	De x	Esp. x	Ha1 x	Ha2
52246	U	248.00 x	270.00 x	— x	17.00 x	—	—	U04A	254.00 x	298.45 x	— x	22.22 x	—
—	CH	248.00 x	278.00 x	— x	76.50 x	—	50217	U074	254.10 x	295.50 x	— x	25.40 x	—
—	CH	248.00 x	300.00 x	— x	79.00 x	—	58656	U001	255.00 x	265.00 x	— x	34.00 x	—
58627	U001	248.30 x	295.00 x	— x	22.00 x	—	58657	U001	255.00 x	285.00 x	— x	15.00 x	—
58628	U002	248.30 x	295.00 x	— x	22.00 x	—	58658	U002	255.00 x	285.00 x	— x	15.00 x	—
52908	U	248.50 x	288.00 x	— x	21.30 x	—	—	CH	255.00 x	285.00 x	— x	66.50 x	—
52908	U056	248.50 x	288.00 x	— x	21.30 x	—	52285	U	256.00 x	278.00 x	— x	7.00 x	—
8143	V	249.22 x	277.81 x	— x	14.00 x	—	52285	U004	256.00 x	278.00 x	— x	17.00 x	—
58629	U001	250.00 x	259.00 x	— x	8.00 x	—	58659	U001	256.00 x	280.00 x	— x	12.00 x	—
58630	U002	250.00 x	259.00 x	— x	8.00 x	—	58660	U002	256.00 x	280.00 x	— x	12.00 x	—
58631	U005	250.00 x	264.00 x	— x	12.00 x	—	52529	U001	257.00 x	300.00 x	— x	20.00 x	—
58632	U006	250.00 x	264.00 x	— x	12.00 x	—	52529	U001	257.00 x	300.00 x	— x	20.00 x	—
58633	U002	250.00 x	270.00 x	— x	11.00 x	—	3204	C	257.12 x	304.80 x	4.80 x	18.70 x	—
50871	U002	250.00 x	270.00 x	— x	15.00 x	—	58661	U007	258.00 x	270.00 x	— x	14.00 x	—
50871	U002	250.00 x	270.00 x	— x	15.00 x	—	58662	U008	258.00 x	270.00 x	— x	14.00 x	—
58634	U002	250.00 x	271.00 x	— x	13.00 x	—	59275	U002	258.50 x	292.00 x	— x	17.00 x	—
8079	V	250.00 x	280.00 x	— x	13.00 x	—	—	CH	259.00 x	286.00 x	— x	72.50 x	—
53491	U04A	250.00 x	280.00 x	— x	21.00 x	—	53468	U004	259.00 x	290.00 x	— x	16.00 x	—
58635	U004	250.00 x	280.00 x	— x	22.00 x	—	59276	U002	259.00 x	292.00 x	— x	17.00 x	—
58636	U001	250.00 x	280.00 x	— x	25.00 x	—	58663	U001	260.00 x	285.00 x	— x	12.00 x	—
58637	U002	250.00 x	280.00 x	— x	25.00 x	—	58664	U002	260.00 x	285.00 x	— x	12.00 x	—
58638	U001	250.00 x	280.00 x	— x	26.00 x	—	—	CH	260.00 x	290.00 x	— x	62.00 x	—
58639	U002	250.00 x	280.00 x	— x	26.00 x	—	—	CH	260.00 x	290.00 x	— x	64.00 x	—
—	CH	250.00 x	280.00 x	— x	54.00 x	—	—	CH	260.00 x	290.00 x	— x	71.00 x	—
6138	CH	250.00 x	280.00 x	— x	60.00 x	—	59249	U04A	260.00 x	292.00 x	— x	18.00 x	—
—	CH	250.00 x	280.00 x	— x	68.80 x	—	58665	U001	260.00 x	296.00 x	— x	18.00 x	—
—	CH	250.00 x	280.00 x	— x	68.80 x	—	58666	U002	260.00 x	296.00 x	— x	18.00 x	—
—	CH	250.00 x	280.00 x	— x	91.00 x	—	58667	U001	260.00 x	300.00 x	— x	20.00 x	—
—	CH	250.00 x	280.00 x	— x	175.50 x	—	58668	U002	260.00 x	300.00 x	— x	20.00 x	—
51768	U	250.00 x	282.00 x	— x	16.00 x	—	58669	U019	260.00 x	300.00 x	— x	20.00 x	—
58640	U001	250.00 x	282.00 x	— x	16.00 x	—	58670	U001	260.00 x	300.00 x	— x	34.00 x	—
51909	U002	250.00 x	282.00 x	— x	16.00 x	—	58671	U002	260.00 x	300.00 x	— x	34.00 x	—
53370	U	250.00 x	285.00 x	— x	25.00 x	—	—	CH	260.00 x	300.00 x	— x	72.00 x	—
53522	U04A	250.00 x	285.00 x	— x	32.00 x	—	58672	U002	260.35 x	292.10 x	— x	25.00 x	—
58641	U001	250.00 x	286.00 x	— x	18.00 x	—	58673	U001	260.40 x	292.10 x	— x	25.00 x	—
58642	U002	250.00 x	286.00 x	— x	18.00 x	—	51456	U003	261.05 x	298.50 x	— x	20.00 x	—
58643	U001	250.00 x	289.00 x	— x	20.00 x	—	3176	C	261.94 x	431.80 x	8.00 x	33.00 x	—
58644	U002	250.00 x	289.00 x	— x	20.00 x	—	52338	U	263.00 x	275.00 x	— x	7.20 x	—
58645	U002	250.00 x	290.00 x	— x	20.00 x	—	58674	U002	263.53 x	292.58 x	— x	11.91 x	—
58646	U003	250.00 x	290.00 x	— x	20.00 x	—	6147	CH	264.00 x	292.00 x	— x	63.00 x	—
50775	U005	250.00 x	290.00 x	— x	20.00 x	—	8185	V	264.00 x	305.00 x	— x	15.00 x	—
58647	U019	250.00 x	290.00 x	— x	20.00 x	—	58675	U	265.00 x	295.00 x	— x	25.00 x	—
58648	U019	250.00 x	290.00 x	— x	25.00 x	—	—	CH	265.00 x	295.00 x	— x	66.50 x	—
58649	U001	250.00 x	290.00 x	— x	34.00 x	—	3428	C	265.70 x	358.75 x	— x	7.00 x	—
58651	U001	250.00 x	295.00 x	— x	22.00 x	—	3428	C	265.70 x	358.75 x	— x	22.30 x	—
58650	U002	250.00 x	295.00 x	— x	22.00 x	—	3428	C	265.70 x	358.75 x	7.00 x	22.30 x	—
58652	U001	250.00 x	295.00 x	— x	25.00 x	—	58676	U019	266.70 x	304.80 x	— x	22.23 x	—
3121	C	250.00 x	300.00 x	5.50 x	23.00 x	—	58677	U004	266.70 x	304.80 x	— x	25.40 x	—
3309	C	250.00 x	310.00 x	5.00 x	27.00 x	—	6326	CH	266.70 x	304.80 x	— x	44.50 x	—
51640	U051	252.00 x	280.00 x	— x	15.00 x	—	3508	C	266.70 x	355.60 x	— x	22.22 x	—
—	CH	252.00 x	285.00 x	— x	123.00 x	—	3508	C	266.70 x	355.60 x	6.35 x	22.22 x	—
50687	U	252.00 x	290.00 x	— x	30.00 x	—	3514	C	266.70 x	357.00 x	— x	22.22 x	—
—	CH	252.00 x	304.00 x	— x	79.00 x	—	51076	U002	267.00 x	303.00 x	— x	30.00 x	—
—	CH	253.00 x	292.00 x	— x	63.00 x	—	58678	U001	268.00 x	292.00 x	— x	12.00 x	—
51432	U001	253.00 x	304.00 x	— x	30.00 x	—	58679	U002	268.00 x	292.00 x	— x	12.00 x	—
52491	U	254.00 x	273.05 x	— x	9.50 x	—	6399	CH	269.00 x	310.00 x	— x	63.00 x	—
52491	U004	254.00 x	273.05 x	— x	9.50 x	—	58680	U003	269.00 x	320.00 x	— x	25.00 x	—
58653	U001	254.00 x	274.00 x	— x	10.00 x	—	58681	U004	270.00 x	290.00 x	— x	17.00 x	—
58654	U002	254.00 x	274.00 x	— x	10.00 x	—	59223	U	270.00 x	296.25 x	— x	20.00 x	—
—	U04A	254.00 x	279.40 x	— x	12.70 x	—	58682	U005	270.00 x	300.00 x	— x	12.00 x	—
53515	U04A	254.00 x	279.40 x	— x	19.05 x	—	50636	U002	270.00 x	300.00 x	— x	15.00 x	—
—	CH	254.00 x	279.40 x	— x	76.50 x	—	58683	U004	270.00 x	300.00 x	— x	15.00 x	—
—	CH	254.00 x	282.00 x	— x	68.00 x	—	53301	U004	270.00 x	300.00 x	— x	16.00 x	—
—	CH	254.00 x	285.75 x	— x	61.50 x	—	8168	V	270.00 x	300.00 x	— x	16.00 x	—
6052	CH	254.00 x	285.80 x	— x	60.33 x	—	53250	U04A	270.00 x	300.00 x	— x	16.50 x	—
58655	U019	254.00 x	292.10 x	— x	22.23 x	—	F8832	W	270.00 x	300.00 x	— x	18.00 x	—
—	CH	254.00 x	292.10 x	— x	65.00 x	—	58684	U001	270.00 x	300.00 x	— x	20.00 x	—



Cód	Mod	Di x	De x	Esp. x	Ha1 x	Ha2	Cód	Mod	Di x	De x	Esp. x	Ha1 x	Ha2
58685	U002	270.00 x	300.00 x	— x	20.00 x	—	58722	U019	280.00 x	320.00 x	— x	20.00 x	—
51504	U002	270.00 x	300.00 x	— x	22.00 x	—	58723	U004	280.00 x	320.00 x	— x	30.00 x	—
51504	U004	270.00 x	300.00 x	— x	22.00 x	—	6299	CH	280.00 x	320.00 x	— x	73.00 x	—
58686	U004	270.00 x	300.00 x	— x	22.00 x	—	58724	U002	280.00 x	330.00 x	— x	25.00 x	—
58687	U004	270.00 x	300.00 x	— x	30.00 x	—	58725	U001	280.00 x	330.00 x	— x	25.40 x	—
6124	CH	270.00 x	300.00 x	— x	32.00 x	—	—	CH	280.59 x	318.90 x	— x	88.00 x	—
6180	CH	270.00 x	300.00 x	— x	38.00 x	—	58726	U019	281.00 x	318.00 x	— x	19.00 x	—
6149	CH	270.00 x	300.00 x	— x	60.00 x	—	59260	U	283.00 x	321.00 x	— x	28.00 x	—
8402	V	270.00 x	310.00 x	— x	15.50 x	—	58727	U002	284.16 x	304.80 x	— x	15.88 x	—
58688	U001	270.00 x	310.00 x	— x	20.00 x	—	51578	U031	284.50 x	305.80 x	— x	12.00 x	—
58689	U002	270.00 x	310.00 x	— x	20.00 x	—	51577	U	285.00 x	300.00 x	— x	15.00 x	12.00
58690	U002	270.00 x	315.00 x	— x	25.00 x	—	58728	U001	285.00 x	304.00 x	— x	10.00 x	—
58691	U001	270.00 x	320.00 x	— x	25.00 x	—	58729	U002	285.00 x	310.00 x	— x	11.00 x	—
58692	U002	270.00 x	320.00 x	— x	25.00 x	—	58730	U005	285.00 x	310.00 x	— x	24.50 x	—
52552	U008	270.00 x	345.00 x	— x	37.00 x	—	58731	U006	285.00 x	310.00 x	— x	24.50 x	—
58693	U	271.00 x	296.65 x	— x	20.00 x	—	52393	U	285.00 x	315.00 x	— x	25.00 x	—
8140	V	272.50 x	306.00 x	— x	16.00 x	—	58732	U001	285.00 x	325.00 x	— x	20.00 x	—
6271	CH	272.50 x	306.00 x	— x	52.00 x	—	58733	U002	285.00 x	325.00 x	— x	20.00 x	—
58694	U008	273.00 x	305.00 x	— x	19.00 x	—	58734	U001	285.00 x	330.00 x	— x	34.00 x	—
8424	V	273.00 x	320.00 x	— x	19.50 x	—	58735	U002	285.00 x	330.00 x	— x	34.00 x	—
53428	U004	273.05 x	304.80 x	— x	40.00 x	—	58736	U002	285.75 x	304.80 x	— x	9.53 x	—
6281	CH	273.05 x	304.80 x	— x	60.32 x	—	—	U04A	285.75 x	311.15 x	— x	12.70 x	—
—	CH	274.00 x	294.00 x	— x	45.50 x	—	—	CH	285.75 x	311.15 x	— x	58.50 x	—
—	CH	274.00 x	306.00 x	— x	59.00 x	—	58737	U002	285.75 x	317.50 x	— x	20.64 x	—
58695	U019	275.00 x	300.00 x	— x	15.00 x	—	58738	U007	286.00 x	300.00 x	— x	12.00 x	—
58696	U004	275.00 x	305.00 x	— x	20.00 x	—	58739	U008	286.00 x	300.00 x	— x	12.00 x	—
58697	U019	275.00 x	308.00 x	— x	15.00 x	—	50936	U	286.00 x	304.80 x	— x	9.50 x	—
58698	U002	275.00 x	308.50 x	— x	15.00 x	—	50936	U002	286.00 x	304.80 x	— x	9.50 x	—
58699	U001	275.00 x	315.00 x	— x	20.00 x	—	—	CH	286.00 x	310.00 x	— x	41.00 x	—
58700	U002	275.00 x	315.00 x	— x	20.00 x	—	58740	U001	286.00 x	320.00 x	— x	20.00 x	—
58701	U002	275.00 x	315.00 x	— x	34.00 x	—	58741	U002	286.00 x	320.00 x	— x	20.00 x	—
58702	U002	275.00 x	316.50 x	— x	34.00 x	—	51183	U002	287.00 x	300.00 x	— x	15.00 x	13.00
58703	U007	275.83 x	304.80 x	— x	19.05 x	—	58742	U008	287.30 x	305.30 x	— x	11.10 x	—
53261	U002	276.00 x	300.00 x	— x	12.00 x	—	50557	U031	287.40 x	304.20 x	— x	9.90 x	—
—	CH	277.50 x	315.00 x	— x	59.00 x	—	58743	U001	288.00 x	300.00 x	— x	8.00 x	—
58704	U001	277.81 x	301.63 x	— x	11.51 x	—	58744	U002	288.00 x	300.00 x	— x	8.00 x	—
58705	U031	279.00 x	307.00 x	— x	15.00 x	—	58745	U007	288.00 x	300.00 x	— x	14.00 x	—
58706	U019	279.00 x	309.00 x	— x	15.00 x	—	58746	U008	288.00 x	300.00 x	— x	14.00 x	—
—	U04A	279.40 x	304.80 x	— x	12.70 x	—	6060	CH	288.92 x	304.80 x	— x	22.22 x	—
53025	U005	279.40 x	306.50 x	— x	19.00 x	—	—	CH	289.00 x	319.00 x	— x	87.00 x	—
53025	U013	279.40 x	306.50 x	— x	19.30 x	—	53252	U04A	289.60 x	315.00 x	— x	20.00 x	—
58707	U019	279.40 x	317.50 x	— x	22.23 x	—	58747	U007	290.00 x	305.00 x	— x	15.00 x	—
3306	C	279.40 x	355.60 x	— x	25.40 x	—	58748	U008	290.00 x	305.00 x	— x	15.00 x	—
—	U	279.80 x	304.80 x	— x	19.05 x	—	58749	U007	290.00 x	307.00 x	— x	14.00 x	—
58709	U	280.00 x	200.00 x	— x	14.00 x	16.00	58750	U008	290.00 x	307.00 x	— x	14.00 x	—
58710	U004	280.00 x	230.00 x	— x	30.00 x	—	58751	U003	290.00 x	308.00 x	— x	12.00 x	—
58708	U004	280.00 x	300.00 x	— x	15.00 x	—	58752	U001	290.00 x	316.00 x	— x	15.00 x	—
58711	U004	280.00 x	300.00 x	— x	15.00 x	—	58753	U002	290.00 x	316.00 x	— x	15.00 x	—
51984	U002	280.00 x	302.00 x	— x	15.50 x	—	58754	U004	290.00 x	316.00 x	— x	24.00 x	—
—	CH	280.00 x	303.00 x	— x	57.00 x	—	—	CH	290.00 x	325.00 x	— x	69.00 x	—
58712	U001	280.00 x	305.00 x	— x	20.00 x	—	52930	U	290.00 x	326.00 x	— x	18.00 x	—
58713	U002	280.00 x	305.00 x	— x	20.00 x	—	58755	U001	290.00 x	330.00 x	— x	20.00 x	—
6413	CH	280.00 x	305.00 x	— x	38.00 x	—	58756	U002	290.00 x	330.00 x	— x	20.00 x	—
58714	U001	280.00 x	310.00 x	— x	15.00 x	—	52108	U	290.00 x	330.00 x	— x	27.50 x	—
58715	U002	280.00 x	310.00 x	— x	15.00 x	—	3224	C	290.00 x	335.50 x	7.00 x	27.00 x	—
58716	U002	280.00 x	310.00 x	— x	22.00 x	—	58757	U002	291.00 x	305.00 x	— x	10.50 x	—
51804	U004	280.00 x	310.00 x	— x	22.00 x	—	3501	C001	291.00 x	309.00 x	6.00 x	30.00 x	—
58717	U004	280.00 x	310.00 x	— x	22.00 x	—	—	U04A	292.10 x	323.85 x	— x	25.40 x	—
58718	U019	280.00 x	310.00 x	— x	25.00 x	—	58758	U019	292.10 x	330.20 x	— x	22.23 x	—
58719	U002	280.00 x	310.00 x	— x	26.00 x	—	58759	U004	295.00 x	320.00 x	— x	18.00 x	—
6298	CH	280.00 x	310.00 x	— x	73.00 x	—	58760	U004	295.00 x	320.50 x	— x	17.00 x	—
—	CH	280.00 x	310.00 x	— x	76.50 x	—	58761	U004	295.00 x	325.00 x	— x	18.00 x	—
—	CH	280.00 x	315.00 x	— x	50.00 x	—	51293	U	295.00 x	328.00 x	— x	18.50 x	—
58720	U001	280.00 x	320.00 x	— x	20.00 x	—	50069	U046	295.00 x	445.00 x	— x	10.00 x	—
51233	U001	280.00 x	320.00 x	— x	20.00 x	—	58762	U001	296.00 x	320.00 x	— x	10.00 x	—
58721	U002	280.00 x	320.00 x	— x	20.00 x	—	58763	U002	296.00 x	320.00 x	— x	10.00 x	—
50234	U003	280.00 x	320.00 x	— x	20.00 x	—	58764	U007	296.00 x	320.00 x	— x	15.00 x	—



Cód	Mod	Di x	De x	Esp. x	Ha1 x	Ha2	Cód	Mod	Di x	De x	Esp. x	Ha1 x	Ha2
—	CH	297.00 x	332.00 x	— x	62.00 x	—	—	CH	310.00 x	340.00 x	— x	99.00 x	—
—	CH	297.00 x	334.00 x	— x	62.00 x	—	52231	U001	310.00 x	350.00 x	— x	20.00 x	—
6108	CH	298.00 x	354.00 x	— x	100.00 x	—	58804	U001	310.00 x	350.00 x	— x	20.00 x	—
53447	U	299.00 x	341.00 x	— x	35.00 x	—	58805	U019	310.00 x	350.00 x	— x	20.00 x	—
59228	U001	299.90 x	349.30 x	— x	26.00 x	—	58806	U001	310.00 x	355.00 x	— x	38.00 x	—
51070	U	300.00 x	320.00 x	— x	31.00 x	32.50	58807	U002	310.00 x	355.00 x	— x	38.00 x	—
58765	U005	300.00 x	326.00 x	— x	24.50 x	—	58808	U001	310.00 x	360.00 x	— x	25.00 x	—
58766	U006	300.00 x	326.00 x	— x	24.50 x	—	58809	U002	310.00 x	360.00 x	— x	25.00 x	—
58767	U002	300.00 x	330.00 x	— x	16.00 x	—	58810	U004	311.15 x	330.20 x	— x	16.67 x	—
51699	U005	300.00 x	330.00 x	— x	16.00 x	—	—	U04A	311.15 x	336.55 x	— x	19.05 x	—
F9050	W	300.00 x	330.00 x	— x	18.80 x	—	—	CH	313.53 x	337.34 x	— x	43.00 x	—
58768	U004	300.00 x	330.00 x	— x	22.00 x	—	6061	CH	314.32 x	352.42 x	— x	47.62 x	—
58769	U005	300.00 x	330.00 x	— x	29.00 x	—	—	CH	314.33 x	352.43 x	— x	52.00 x	—
58770	U006	300.00 x	330.00 x	— x	29.00 x	—	58811	U007	315.00 x	335.00 x	— x	15.00 x	—
6301	CH	300.00 x	330.00 x	— x	73.00 x	—	—	CH	315.00 x	335.00 x	— x	85.50 x	—
53413	U031	300.00 x	335.00 x	— x	25.00 x	—	58812	U002	315.00 x	340.00 x	— x	12.00 x	—
6311	CH	300.00 x	335.00 x	— x	40.00 x	—	58813	U001	315.00 x	340.00 x	— x	12.50 x	—
58771	U001	300.00 x	336.00 x	— x	18.00 x	—	—	U04A	315.00 x	341.00 x	— x	19.00 x	—
58772	U002	300.00 x	336.00 x	— x	18.00 x	—	58814	U001	315.00 x	355.00 x	— x	20.00 x	—
58773	U001	300.00 x	337.00 x	— x	30.00 x	—	58815	U002	315.00 x	355.00 x	— x	20.00 x	—
58774	U002	300.00 x	337.00 x	— x	30.00 x	—	F8946	J	315.00 x	356.75 x	— x	35.00 x	—
58775	U004	300.00 x	340.00 x	— x	20.00 x	—	58816	U001	315.00 x	365.00 x	— x	25.00 x	—
58776	U019	300.00 x	340.00 x	— x	20.00 x	—	58817	U002	315.00 x	365.00 x	— x	25.00 x	—
58777	U001	300.00 x	340.00 x	— x	40.00 x	—	58818	U001	316.00 x	360.00 x	— x	34.00 x	—
3280	C	300.00 x	350.00 x	— x	25.00 x	—	58819	U002	316.00 x	360.00 x	— x	34.00 x	—
58778	U001	300.00 x	350.00 x	— x	25.00 x	—	—	U04A	317.50 x	336.55 x	— x	9.52 x	—
58779	U002	300.00 x	350.00 x	— x	25.00 x	—	51323	U	317.50 x	355.60 x	— x	19.05 x	—
59337	U001	300.00 x	350.00 x	— x	28.50 x	—	58820	U001	317.50 x	355.60 x	— x	22.20 x	—
58780	U004	300.00 x	370.00 x	— x	28.00 x	—	58821	U002	317.50 x	355.60 x	— x	22.20 x	—
—	CH	300.65 x	335.17 x	— x	62.00 x	—	58822	U019	317.50 x	355.60 x	— x	22.23 x	—
—	CH	301.00 x	344.00 x	— x	68.00 x	—	—	CH	317.50 x	355.60 x	— x	66.00 x	—
58781	U001	302.00 x	340.00 x	— x	30.00 x	—	—	CH	317.50 x	368.30 x	— x	88.00 x	—
58782	U001	303.00 x	345.00 x	— x	30.00 x	—	58823	U001	318.00 x	330.00 x	— x	6.00 x	—
58783	U002	303.00 x	345.00 x	— x	30.00 x	—	58824	U002	318.00 x	330.00 x	— x	6.00 x	—
—	CH	303.21 x	335.17 x	— x	54.00 x	—	—	CH	318.00 x	360.00 x	— x	64.00 x	—
59311	U04A	303.50 x	352.50 x	— x	29.00 x	—	—	CH	319.00 x	348.00 x	— x	62.00 x	—
58784	U001	304.00 x	330.20 x	— x	20.00 x	—	55752	U	319.00 x	373.50 x	— x	23.00 x	—
58785	U001	304.00 x	340.00 x	— x	20.00 x	—	58825	U001	320.00 x	336.00 x	— x	8.00 x	—
58786	U002	304.00 x	340.00 x	— x	20.00 x	—	58826	U002	320.00 x	336.00 x	— x	8.00 x	—
—	CH	304.40 x	349.25 x	— x	68.00 x	—	58827	U019	320.00 x	340.00 x	— x	13.00 x	—
51131	U002	304.80 x	322.26 x	— x	9.50 x	—	52838	U005	320.00 x	350.00 x	— x	15.00 x	—
53847	U04A	304.80 x	330.20 x	— x	12.70 x	—	58828	U004	320.00 x	350.00 x	— x	16.00 x	—
58787	U002	304.80 x	330.20 x	— x	20.00 x	—	58829	U002	320.00 x	350.00 x	— x	22.00 x	—
58789	U001	304.80 x	330.20 x	— x	22.23 x	—	50405	U004	320.00 x	350.00 x	— x	22.00 x	—
58790	U019	304.80 x	336.54 x	— x	15.88 x	—	58830	U004	320.00 x	350.00 x	— x	22.00 x	—
58791	U002	304.80 x	338.14 x	— x	22.00 x	—	58831	U001	320.00 x	350.00 x	— x	25.00 x	—
53249	U04A	304.80 x	340.00 x	— x	16.50 x	—	58832	U002	320.00 x	350.00 x	— x	25.00 x	—
53249	U04A	304.80 x	340.00 x	— x	16.50 x	—	58833	U001	320.00 x	350.00 x	— x	26.00 x	—
—	CH	304.80 x	341.31 x	— x	87.00 x	—	58834	U002	320.00 x	350.00 x	— x	26.00 x	—
58792	U019	304.80 x	342.90 x	— x	22.23 x	—	58835	U001	320.00 x	350.00 x	— x	38.00 x	—
58793	U002	304.80 x	342.90 x	— x	28.58 x	—	58836	U002	320.00 x	350.00 x	— x	38.00 x	—
58794	U001	304.80 x	342.90 x	— x	28.60 x	—	—	CH	320.00 x	350.00 x	— x	66.50 x	—
—	CH	304.80 x	342.90 x	— x	57.00 x	—	—	CH	320.00 x	350.00 x	— x	70.00 x	—
6324	CH	304.80 x	342.90 x	— x	63.10 x	—	58837	U001	320.00 x	360.00 x	— x	20.00 x	—
—	CH	305.00 x	347.00 x	— x	63.50 x	—	58838	U002	320.00 x	360.00 x	— x	20.00 x	—
58795	U002	305.00 x	355.00 x	— x	25.00 x	—	50741	U019	320.00 x	360.00 x	— x	20.00 x	—
58796	U001	305.80 x	355.00 x	— x	25.00 x	—	58839	U019	320.00 x	360.00 x	— x	20.00 x	—
—	CH	306.00 x	330.00 x	— x	36.00 x	—	58840	U004	320.00 x	360.00 x	— x	28.00 x	—
51431	U	307.00 x	326.00 x	— x	11.00 x	—	58841	U001	320.00 x	360.00 x	— x	34.00 x	—
58797	U002	310.00 x	330.00 x	— x	17.00 x	—	58842	U002	320.00 x	360.00 x	— x	34.00 x	—
58798	U004	310.00 x	330.00 x	— x	17.00 x	—	58843	U001	320.00 x	360.00 x	— x	35.00 x	—
58799	U002	310.00 x	332.00 x	— x	10.00 x	—	58844	U002	320.00 x	360.00 x	— x	35.00 x	—
52307	U	310.00 x	335.00 x	— x	16.00 x	—	6355	CH	320.00 x	360.00 x	— x	64.00 x	—
58800	U005	310.00 x	340.00 x	— x	12.00 x	—	58845	U001	320.00 x	362.00 x	— x	40.00 x	—
58801	U006	310.00 x	340.00 x	— x	12.00 x	—	58846	U002	320.00 x	362.00 x	— x	40.00 x	—
58802	U001	310.00 x	340.00 x	— x	26.00 x	—	—	CH	320.00 x	362.00 x	— x	91.00 x	—
58803	U002	310.00 x	340.00 x	— x	26.00 x	—	58847	U001	320.00 x	366.00 x	— x	34.00 x	—





Cód	Mod	Di x	De x	Esp. x	Ha1 x	Ha2	Cód	Mod	Di x	De x	Esp. x	Ha1 x	Ha2
58848	U002	320.00 x	366.00 x	— x	34.00 x	—	50615	U020	350.00 x	370.00 x	— x	15.00 x	—
53392	U04A	320.00 x	368.30 x	— x	20.00 x	—	58889	U002	350.00 x	380.00 x	— x	17.00 x	—
58849	U004	320.00 x	650.00 x	— x	25.00 x	—	53465	U001	350.00 x	380.00 x	— x	17.50 x	—
58850	U002	324.00 x	340.00 x	— x	10.00 x	—	58890	U004	350.00 x	380.00 x	— x	19.00 x	—
58851	U001	324.00 x	348.00 x	— x	12.00 x	—	6316	CH	350.00 x	380.00 x	— x	34.00 x	—
58852	U002	324.00 x	348.00 x	— x	12.00 x	—	—	CH	350.00 x	380.00 x	— x	66.50 x	—
53338	U002	325.00 x	354.00 x	— x	16.50 x	—	55685	U04A	350.00 x	385.00 x	— x	20.00 x	—
6420	CH	325.00 x	355.00 x	— x	100.00 x	—	58891	U001	350.00 x	389.00 x	— x	34.00 x	—
51474	U001	326.00 x	362.00 x	— x	25.00 x	—	—	CH	350.00 x	389.00 x	— x	65.00 x	—
58853	U002	327.00 x	347.00 x	— x	14.00 x	—	58892	U019	350.00 x	390.00 x	— x	25.00 x	—
6072	CH	328.00 x	370.00 x	— x	56.00 x	—	58893	U	350.00 x	390.00 x	— x	28.00 x	—
51749	U	329.50 x	354.50 x	— x	12.90 x	—	58894	U	350.00 x	390.00 x	— x	35.00 x	—
58854	U007	330.00 x	345.00 x	— x	14.00 x	—	—	CH	350.00 x	390.00 x	— x	86.00 x	—
58855	U008	330.00 x	345.00 x	— x	14.00 x	—	58895	U001	350.00 x	400.00 x	— x	25.00 x	—
58856	U001	330.00 x	355.00 x	— x	20.00 x	—	58896	U019	350.00 x	400.00 x	— x	25.00 x	—
58857	U002	330.00 x	355.00 x	— x	20.00 x	—	58897	U002	350.00 x	400.00 x	— x	26.00 x	—
3524	C	330.00 x	355.60 x	— x	12.70 x	—	58898	U002	351.00 x	390.00 x	— x	24.00 x	—
6315	CH	330.00 x	360.00 x	— x	58.00 x	—	50818	U	352.00 x	392.00 x	— x	31.50 x	—
58858	U002	330.00 x	362.00 x	— x	25.00 x	—	58899	U003	354.00 x	381.00 x	— x	20.64 x	—
58859	U001	330.00 x	366.00 x	— x	18.00 x	—	53227	U04A	355.00 x	375.00 x	— x	10.00 x	—
58860	U002	330.00 x	366.00 x	— x	18.00 x	—	53442	U04A	355.00 x	389.00 x	— x	23.50 x	—
52288	U	330.00 x	370.00 x	— x	20.00 x	—	8422	V	355.00 x	390.00 x	— x	12.00 x	—
58861	U002	330.00 x	370.00 x	— x	20.00 x	—	53450	U04A	355.00 x	395.00 x	— x	30.00 x	—
53230	U001	330.00 x	370.00 x	— x	23.00 x	—	58900	U001	355.00 x	400.00 x	— x	28.50 x	—
—	CH	330.00 x	380.00 x	— x	84.00 x	—	58901	U001	355.00 x	405.00 x	— x	25.00 x	—
58862	U001	330.20 x	362.00 x	— x	25.00 x	—	58902	U002	355.00 x	405.00 x	— x	25.00 x	—
58863	U019	330.20 x	368.30 x	— x	22.23 x	—	3551	CH	355.60 x	381.00 x	— x	63.50 x	—
3489	C	330.20 x	457.00 x	— x	56.00 x	—	6462	CH	355.60 x	390.92 x	— x	48.00 x	—
6444	CH	330.30 x	359.30 x	— x	45.10 x	—	58903	U019	355.60 x	393.70 x	— x	22.23 x	—
51295	U085	334.00 x	360.00 x	— x	23.50 x	17.00	3511	C	355.60 x	431.80 x	— x	31.75 x	—
58864	U007	335.00 x	350.00 x	— x	15.00 x	—	53471	U04A	356.00 x	394.00 x	— x	25.00 x	—
58865	U008	335.00 x	350.00 x	— x	15.00 x	—	58904	U007	360.00 x	380.00 x	— x	33.00 x	—
51597	U	335.00 x	359.00 x	— x	25.00 x	—	50761	U019	360.00 x	390.00 x	— x	15.00 x	—
58866	U002	335.00 x	363.00 x	— x	16.00 x	—	51023	U004	360.00 x	390.00 x	— x	22.00 x	—
58867	U019	336.55 x	381.00 x	— x	22.23 x	—	58905	U004	360.00 x	390.00 x	— x	22.00 x	—
58868	U001	337.00 x	350.00 x	— x	10.00 x	—	51023	U004	360.00 x	390.00 x	— x	22.00 x	—
58869	U002	337.00 x	350.00 x	— x	10.00 x	—	51023	U004	360.00 x	390.00 x	— x	22.00 x	—
58870	U007	338.00 x	350.00 x	— x	14.00 x	—	—	CH	360.00 x	390.00 x	— x	100.00 x	—
58871	U008	338.00 x	350.00 x	— x	14.00 x	—	6248	CH	360.00 x	391.00 x	— x	40.00 x	—
58872	U001	338.50 x	372.00 x	— x	25.00 x	—	—	CH	360.00 x	395.00 x	— x	64.00 x	—
58873	U002	338.50 x	372.00 x	— x	25.00 x	—	58906	U001	360.00 x	396.00 x	— x	25.00 x	—
58874	U004	340.00 x	370.00 x	— x	20.00 x	—	58907	U002	360.00 x	396.00 x	— x	25.00 x	—
—	CH	340.00 x	370.00 x	— x	66.50 x	—	58908	U001	360.00 x	400.00 x	— x	20.00 x	—
58875	U001	340.00 x	380.00 x	— x	20.00 x	—	58909	U002	360.00 x	400.00 x	— x	20.00 x	—
58876	U002	340.00 x	380.00 x	— x	20.00 x	—	51676	U002	360.00 x	400.00 x	— x	23.00 x	—
58877	U019	340.00 x	380.00 x	— x	20.00 x	—	51676	U002	360.00 x	400.00 x	— x	23.00 x	—
51541	U033	340.00 x	381.00 x	— x	16.00 x	—	58910	U001	360.00 x	400.00 x	— x	25.00 x	—
51541	U033	340.00 x	381.00 x	— x	16.00 x	—	58912	U001	360.00 x	400.00 x	— x	34.00 x	—
58878	U001	340.00 x	390.00 x	— x	32.00 x	—	58913	U002	360.00 x	400.00 x	— x	35.00 x	—
58879	U002	340.00 x	390.00 x	— x	32.00 x	—	58914	U001	360.00 x	410.00 x	— x	30.00 x	—
—	CH	340.00 x	390.00 x	— x	98.00 x	—	58915	U002	360.00 x	410.00 x	— x	30.00 x	—
58880	U001	340.00 x	580.00 x	— x	20.00 x	—	58916	U002	360.00 x	420.00 x	— x	33.00 x	—
6154	CH	342.90 x	381.00 x	— x	74.61 x	—	53470	U04A	360.60 x	400.00 x	— x	30.00 x	—
58881	U019	342.90 x	387.35 x	— x	22.23 x	—	58917	U001	364.50 x	402.50 x	— x	34.00 x	—
58882	U007	345.00 x	360.00 x	— x	14.00 x	—	58918	U002	364.50 x	402.50 x	— x	34.00 x	—
52779	U007	345.00 x	360.00 x	— x	14.00 x	—	58919	U001	365.00 x	405.00 x	— x	20.00 x	—
58883	U008	345.00 x	360.00 x	— x	14.00 x	—	58920	U004	365.00 x	405.00 x	— x	28.00 x	—
58884	U019	345.00 x	380.00 x	— x	20.00 x	—	58921	U019	366.00 x	406.00 x	— x	22.00 x	—
59422	U002	345.00 x	385.00 x	— x	20.00 x	—	58922	U002	370.00 x	400.00 x	— x	22.00 x	—
6317	CH	345.00 x	385.00 x	— x	75.00 x	—	51472	U004	370.00 x	400.00 x	— x	22.00 x	—
58885	U004	345.00 x	395.00 x	— x	27.00 x	—	51472	U004	370.00 x	400.00 x	— x	22.00 x	—
58886	U004	345.00 x	395.00 x	— x	36.00 x	—	58923	U004	370.00 x	400.00 x	— x	25.00 x	—
—	CH	346.00 x	381.00 x	— x	99.00 x	—	6446	CH	370.00 x	400.00 x	— x	50.00 x	—
58887	U001	347.00 x	400.00 x	— x	25.00 x	—	—	CH	370.00 x	402.00 x	— x	73.80 x	—
58888	U002	347.00 x	400.00 x	— x	25.00 x	—	52919	U	371.00 x	396.00 x	— x	15.80 x	—
8400	V	349.00 x	386.00 x	— x	20.00 x	—	52919	U004	371.00 x	396.00 x	— x	15.80 x	—
52451	U004	350.00 x	369.00 x	— x	13.80 x	—	52907	U	374.00 x	330.00 x	— x	20.30 x	—



Cód	Mod	Di x	De x	Esp. x	Ha1 x	Ha2	Cód	Mod	Di x	De x	Esp. x	Ha1 x	Ha2
52907	U	374.00 x	330.00 x	— x	20.30 x	—	58966	U002	400.00 x	430.00 x	— x	15.00 x	—
52033	U004	374.60 x	400.00 x	— x	12.70 x	—	51375	U	400.00 x	430.00 x	— x	25.00 x	—
52034	U	374.60 x	400.00 x	— x	19.05 x	—	58967	U001	400.00 x	430.00 x	— x	26.00 x	—
52034	U004	374.60 x	400.00 x	— x	19.05 x	—	58968	U001	400.00 x	430.00 x	— x	26.00 x	—
58924	U001	375.00 x	315.00 x	— x	34.00 x	—	58969	U002	400.00 x	430.00 x	— x	26.00 x	—
58925	U001	375.00 x	316.50 x	— x	34.00 x	—	—	CH	400.00 x	430.00 x	— x	97.50 x	—
58926	U007	375.00 x	390.00 x	— x	15.00 x	—	58972	U04A	400.00 x	435.00 x	— x	20.00 x	—
58927	U008	375.00 x	390.00 x	— x	15.00 x	—	58970	U001	400.00 x	440.00 x	— x	20.00 x	—
58928	U007	375.00 x	400.00 x	— x	24.00 x	—	58971	U002	400.00 x	440.00 x	— x	20.00 x	—
58929	U008	375.00 x	400.00 x	— x	24.00 x	—	—	CH	400.00 x	440.00 x	— x	66.50 x	—
52513	U001	375.00 x	406.00 x	— x	17.00 x	—	—	CH	400.00 x	440.00 x	— x	89.50 x	—
58930	U001	375.00 x	410.00 x	— x	25.00 x	—	—	CH	400.00 x	441.00 x	— x	98.00 x	—
58931	U002	375.00 x	410.00 x	— x	25.00 x	—	—	CH	400.00 x	445.00 x	— x	58.50 x	—
58932	U001	375.00 x	420.00 x	— x	20.00 x	—	—	CH	400.00 x	445.50 x	— x	63.00 x	—
58933	U002	375.00 x	420.00 x	— x	20.00 x	—	58973	U001	400.00 x	450.00 x	— x	25.00 x	—
58934	U002	377.83 x	409.58 x	— x	15.00 x	—	58974	U002	400.00 x	450.00 x	— x	25.00 x	—
58935	U004	380.00 x	240.00 x	— x	28.00 x	—	58975	U019	400.00 x	450.00 x	— x	25.00 x	—
58936	U004	380.00 x	400.00 x	— x	20.00 x	—	58976	U004	401.00 x	445.00 x	— x	28.00 x	—
53192	U004	380.00 x	410.00 x	— x	16.50 x	—	58977	U002	405.00 x	434.00 x	— x	16.00 x	—
58937	U004	380.00 x	410.00 x	— x	22.00 x	—	58978	U001	405.00 x	450.00 x	— x	22.00 x	—
—	CH	380.00 x	410.00 x	— x	46.50 x	—	58979	U002	405.00 x	450.00 x	— x	22.00 x	—
—	CH	380.00 x	410.00 x	— x	66.50 x	—	58980	U001	405.00 x	450.00 x	— x	30.00 x	—
58938	U002	380.00 x	420.00 x	— x	15.00 x	—	58981	U004	406.00 x	457.00 x	— x	32.00 x	—
58939	U001	380.00 x	420.00 x	— x	20.00 x	—	58982	U019	406.40 x	444.50 x	— x	22.23 x	—
58940	U002	380.00 x	420.00 x	— x	20.00 x	—	—	CH	406.40 x	444.50 x	— x	61.00 x	—
58941	U019	380.00 x	420.00 x	— x	26.50 x	—	—	CH	406.40 x	444.50 x	— x	79.00 x	—
6369	CH	380.00 x	420.00 x	— x	66.00 x	—	58983	U001	408.00 x	442.00 x	— x	20.00 x	—
58942	U001	380.00 x	425.00 x	— x	20.00 x	—	58984	U002	408.00 x	442.00 x	— x	20.00 x	—
58943	U002	380.00 x	425.00 x	— x	20.00 x	—	58985	U001	410.00 x	450.00 x	— x	20.00 x	—
58944	U001	380.00 x	440.00 x	— x	45.00 x	—	58986	U002	410.00 x	450.00 x	— x	20.00 x	—
58945	U002	380.00 x	440.00 x	— x	45.00 x	—	8366	V	410.00 x	450.00 x	— x	23.00 x	—
52955	U004	381.00 x	407.00 x	— x	15.80 x	—	58987	U004	410.00 x	450.00 x	— x	28.00 x	—
52955	U	381.00 x	407.00 x	— x	16.00 x	—	6344	CH	410.00 x	450.00 x	— x	48.00 x	—
58946	U019	381.00 x	419.10 x	— x	22.23 x	—	58988	U001	410.00 x	455.00 x	— x	38.00 x	—
58947	U001	384.50 x	451.80 x	— x	30.00 x	—	58989	U002	410.00 x	455.00 x	— x	38.00 x	—
58948	U002	384.50 x	451.80 x	— x	30.00 x	—	58990	U001	410.00 x	460.00 x	— x	30.00 x	—
6176	CH	385.00 x	415.00 x	— x	54.00 x	—	58991	U002	410.00 x	460.00 x	— x	30.00 x	—
58949	U001	385.50 x	406.50 x	— x	15.87 x	—	58992	U001	412.00 x	448.00 x	— x	20.00 x	—
52386	U	386.25 x	403.00 x	— x	13.00 x	—	58993	U002	412.00 x	448.00 x	— x	20.00 x	—
3184	C	388.00 x	440.00 x	6.50 x	23.50 x	—	58994	U003	414.00 x	452.00 x	— x	19.00 x	—
58950	U007	390.00 x	406.00 x	— x	14.00 x	—	—	CH	415.00 x	450.00 x	— x	56.00 x	—
58951	U008	390.00 x	406.00 x	— x	14.00 x	—	58995	U002	415.00 x	455.00 x	— x	20.00 x	—
58952	U001	390.00 x	415.00 x	— x	15.00 x	—	58996	U019	416.10 x	457.20 x	— x	22.23 x	—
58953	U002	390.00 x	415.00 x	— x	15.00 x	—	6389	CH	417.00 x	447.00 x	— x	74.00 x	—
8333	V	390.00 x	420.00 x	— x	15.00 x	—	58997	U004	418.00 x	468.00 x	— x	33.00 x	—
—	CH	390.00 x	420.00 x	— x	66.50 x	—	58998	U001	419.00 x	457.00 x	— x	22.00 x	—
58954	U004	390.00 x	422.00 x	— x	22.00 x	—	—	CH	419.00 x	457.00 x	— x	85.00 x	—
58955	U001	390.00 x	427.00 x	— x	25.00 x	—	58999	U001	420.00 x	450.00 x	— x	15.00 x	—
58956	U002	390.00 x	427.00 x	— x	25.00 x	—	59000	U002	420.00 x	450.00 x	— x	15.00 x	—
51752	U001	390.00 x	430.00 x	— x	21.00 x	—	59001	U004	420.00 x	450.00 x	— x	15.40 x	—
52521	U013	392.00 x	420.00 x	— x	19.00 x	—	53095	U	420.00 x	450.00 x	— x	18.00 x	—
3278	C	392.00 x	454.00 x	— x	29.00 x	—	59002	U004	420.00 x	450.00 x	— x	22.00 x	—
3521	C	393.50 x	510.00 x	7.00 x	25.00 x	—	59003	U004	420.00 x	450.00 x	— x	25.00 x	—
58957	U019	393.70 x	431.80 x	— x	22.23 x	—	59004	U001	420.00 x	452.00 x	— x	26.00 x	—
6152	CH	393.70 x	431.80 x	— x	74.60 x	—	59005	U002	420.00 x	452.00 x	— x	26.00 x	—
3497	C	393.70 x	508.00 x	— x	25.40 x	—	51751	U	420.00 x	460.00 x	— x	20.00 x	—
3490	C001	393.70 x	508.00 x	— x	25.40 x	—	—	CH	420.00 x	460.00 x	— x	60.00 x	—
58958	U004	394.00 x	415.00 x	— x	16.00 x	—	—	CH	420.00 x	460.00 x	— x	83.50 x	—
52172	U074	395.00 x	419.00 x	— x	12.70 x	2.50	59005	U001	420.00 x	480.00 x	— x	30.00 x	—
58959	U001	395.00 x	435.00 x	— x	20.00 x	—	59006	U002	420.00 x	480.00 x	— x	30.00 x	—
58960	U002	395.00 x	435.00 x	— x	20.00 x	—	59007	U001	421.00 x	462.00 x	— x	20.00 x	—
59387	UL	396.87 x	450.85 x	— x	25.40 x	—	59008	U002	421.00 x	462.00 x	— x	20.00 x	—
58961	U001	398.00 x	428.00 x	— x	18.00 x	—	59009	U001	423.00 x	435.00 x	— x	6.00 x	—
58962	U001	398.00 x	438.00 x	— x	20.00 x	—	59010	U002	423.00 x	435.00 x	— x	6.00 x	—
58963	U002	398.00 x	438.00 x	— x	20.00 x	—	59011	U001	425.00 x	450.00 x	— x	20.00 x	—
58964	U001	398.00 x	445.00 x	— x	25.00 x	—	59012	U002	425.00 x	450.00 x	— x	20.00 x	—
58965	U002	398.00 x	445.00 x	— x	25.00 x	—	59013	U003	425.00 x	450.00 x	— x	20.00 x	—



Cód	Mod	Di x	De x	Esp. x	Ha1 x	Ha2	Cód	Mod	Di x	De x	Esp. x	Ha1 x	Ha2
59014	U001	425.00 x	450.00 x	— x	22.00 x	—	59056	U002	460.00 x	500.00 x	— x	20.00 x	—
59015	U002	425.00 x	450.00 x	— x	22.00 x	—	59057	U004	460.00 x	500.00 x	— x	28.00 x	—
59016	U001	425.00 x	465.00 x	— x	34.00 x	—	6232	CH	460.00 x	500.00 x	— x	60.00 x	—
59017	U002	425.00 x	465.00 x	— x	34.00 x	—	59058	U001	460.00 x	510.00 x	— x	32.00 x	—
3208	C	425.45 x	508.00 x	4.76 x	28.57 x	—	59059	U002	460.00 x	510.00 x	— x	32.00 x	—
52480	U	429.06 x	457.80 x	— x	22.22 x	—	59060	U001	460.00 x	510.00 x	— x	42.00 x	—
59018	U004	430.00 x	460.00 x	— x	22.00 x	—	59061	U002	460.00 x	510.00 x	— x	42.00 x	—
59019	U004	430.00 x	470.00 x	— x	20.00 x	—	59062	U001	463.50 x	511.50 x	— x	24.00 x	—
59020	U001	430.00 x	470.00 x	— x	25.00 x	—	59063	U002	463.50 x	511.50 x	— x	24.00 x	—
59021	U002	430.00 x	470.00 x	— x	25.00 x	—	59064	U001	465.00 x	495.00 x	— x	25.00 x	—
59022	U004	430.00 x	470.00 x	— x	28.00 x	—	59065	U002	465.00 x	495.00 x	— x	25.00 x	—
—	CH	430.00 x	470.00 x	— x	90.50 x	—	—	CH	465.00 x	500.00 x	— x	77.00 x	—
51582	U	431.80 x	455.60 x	— x	12.70 x	—	59066	U001	465.00 x	530.00 x	— x	30.00 x	—
59023	U019	431.80 x	469.90 x	— x	22.23 x	—	59067	U002	465.00 x	530.00 x	— x	30.00 x	—
59024	U001	435.00 x	465.00 x	— x	15.00 x	—	59068	U019	469.90 x	508.00 x	— x	19.05 x	—
59025	U001	438.00 x	480.00 x	— x	22.00 x	—	59069	U001	470.00 x	494.00 x	— x	12.00 x	—
51130	U	438.15 x	455.61 x	— x	9.50 x	—	59070	U002	470.00 x	494.00 x	— x	12.00 x	—
59026	U001	440.00 x	470.00 x	— x	30.00 x	—	59071	U004	470.00 x	500.00 x	— x	22.00 x	—
59027	U002	440.00 x	470.00 x	— x	30.00 x	—	59072	U004	470.00 x	510.00 x	— x	28.00 x	—
—	CH	440.00 x	470.00 x	— x	106.00 x	—	—	CH	470.00 x	510.00 x	— x	90.00 x	—
59028	U001	440.00 x	480.00 x	— x	25.00 x	—	59073	U001	470.00 x	530.00 x	— x	30.00 x	—
59029	U002	440.00 x	480.00 x	— x	25.00 x	—	59074	U002	470.00 x	530.00 x	— x	30.00 x	—
59030	U004	440.00 x	480.00 x	— x	28.00 x	—	—	CH	475.00 x	507.00 x	— x	51.00 x	—
—	CH	440.00 x	480.00 x	— x	89.50 x	—	—	CH	475.00 x	515.00 x	— x	91.00 x	—
59031	U001	440.00 x	490.00 x	— x	25.00 x	—	59075	U002	476.00 x	550.00 x	— x	16.50 x	—
59032	U003	443.60 x	406.50 x	— x	25.40 x	—	6256	CH	480.00 x	500.00 x	— x	136.00 x	—
59033	U001	444.00 x	468.00 x	— x	12.00 x	—	—	CH	480.00 x	510.00 x	— x	75.00 x	—
59034	U002	444.00 x	468.00 x	— x	12.00 x	—	6129	CH	480.00 x	520.00 x	— x	50.00 x	—
—	CH	444.50 x	476.25 x	— x	63.00 x	—	6129	CH	480.00 x	520.00 x	— x	50.00 x	—
—	U04A	444.50 x	482.60 x	— x	19.05 x	—	59076	U001	480.00 x	530.00 x	— x	25.00 x	—
59035	U019	444.50 x	482.60 x	— x	22.23 x	—	59077	U002	480.00 x	530.00 x	— x	25.00 x	—
52627	U002	445.00 x	475.00 x	— x	14.50 x	—	50718	U	482.60 x	508.00 x	— x	12.70 x	—
50512	U002	445.00 x	486.00 x	— x	21.00 x	—	50904	U019	482.60 x	508.00 x	— x	20.40 x	—
50512	U002	445.00 x	486.00 x	— x	21.00 x	—	—	CH	482.60 x	515.94 x	— x	67.00 x	—
59036	U001	449.50 x	482.00 x	— x	20.00 x	—	3492	C	482.60 x	558.80 x	— x	6.00 x	—
59037	U002	449.50 x	482.00 x	— x	20.00 x	—	3492	C	482.60 x	558.80 x	— x	32.50 x	—
56242	U001	449.50 x	482.00 x	— x	30.00 x	—	59078	U001	490.00 x	530.00 x	— x	25.00 x	—
59038	U002	449.50 x	482.00 x	— x	30.00 x	—	59079	U002	490.00 x	530.00 x	— x	25.00 x	3.00
50616	U020	450.00 x	470.00 x	— x	15.00 x	—	59080	U004	490.00 x	530.00 x	— x	28.00 x	—
59039	U004	450.00 x	470.00 x	— x	18.00 x	—	—	CH	490.00 x	530.00 x	— x	90.00 x	—
8386	V	450.00 x	480.00 x	— x	16.50 x	—	59081	U001	495.00 x	535.00 x	— x	34.00 x	—
52144	U004	450.00 x	480.00 x	— x	25.00 x	—	59082	U002	495.00 x	535.00 x	— x	34.00 x	—
52144	U004	450.00 x	480.00 x	— x	25.00 x	—	59083	U003	500.00 x	520.00 x	— x	10.00 x	—
6249	CH	450.00 x	480.00 x	— x	60.00 x	—	6201	CH	500.00 x	530.00 x	— x	40.00 x	—
59040	U001	450.00 x	484.00 x	— x	20.00 x	—	6113	CH	500.00 x	535.00 x	— x	65.00 x	—
59041	U002	450.00 x	484.00 x	— x	20.00 x	—	59084	U001	500.00 x	540.00 x	— x	20.00 x	—
59042	U001	450.00 x	489.00 x	— x	34.00 x	—	59085	U004	500.00 x	540.00 x	— x	34.00 x	—
59043	U001	450.00 x	490.00 x	— x	21.00 x	—	52831	U004	500.00 x	540.00 x	— x	34.00 x	—
59044	U002	450.00 x	490.00 x	— x	21.00 x	—	—	CH	500.00 x	540.00 x	— x	101.00 x	—
59047	U002	450.00 x	490.00 x	— x	34.00 x	—	59086	U001	500.00 x	545.00 x	— x	40.00 x	—
—	CH	450.00 x	490.00 x	— x	67.00 x	—	59087	U002	500.00 x	545.00 x	— x	40.00 x	—
59048	U001	450.00 x	500.00 x	— x	25.00 x	—	59088	U001	500.00 x	549.00 x	— x	26.00 x	—
59049	U002	450.00 x	500.00 x	— x	25.00 x	—	59089	U001	500.00 x	550.00 x	— x	25.00 x	—
59050	U019	450.00 x	500.00 x	— x	25.00 x	—	59090	U002	500.00 x	550.00 x	— x	25.00 x	—
59051	U001	450.00 x	500.00 x	— x	26.00 x	—	59091	U001	501.65 x	520.70 x	— x	9.53 x	—
—	CH	451.00 x	476.50 x	— x	58.00 x	—	59092	U002	505.00 x	535.00 x	— x	14.00 x	—
59052	U004	452.00 x	481.00 x	— x	24.00 x	—	59093	U001	505.00 x	538.00 x	— x	26.00 x	—
—	CH	452.00 x	491.00 x	— x	79.00 x	—	59094	U005	505.00 x	545.00 x	— x	33.50 x	—
52615	U	456.00 x	486.00 x	— x	16.00 x	—	53026	U	506.00 x	533.60 x	— x	19.30 x	—
—	CH	457.00 x	495.00 x	— x	79.00 x	—	53026	U013	506.00 x	533.60 x	— x	19.30 x	—
—	CH	457.00 x	495.00 x	— x	83.00 x	—	—	U04A	508.00 x	539.75 x	— x	15.87 x	—
—	CH	457.00 x	497.00 x	— x	165.00 x	—	—	CH	508.00 x	548.00 x	— x	71.00 x	—
—	C	457.00 x	507.50 x	— x	32.00 x	—	—	CH	508.00 x	558.80 x	— x	81.00 x	—
59053	U004	457.00 x	508.00 x	— x	32.00 x	—	3522	C001	508.00 x	609.60 x	— x	50.80 x	—
59054	U019	457.20 x	495.30 x	— x	22.23 x	—	52435	U	508.80 x	558.00 x	— x	31.00 x	—
—	CH	457.20 x	508.00 x	— x	47.50 x	—	59095	U001	510.00 x	550.00 x	— x	20.00 x	—
59055	U001	460.00 x	500.00 x	— x	20.00 x	—	59096	U002	510.00 x	550.00 x	— x	20.00 x	—



Cód	Mod	Di x	De x	Esp. x	Ha1 x	Ha2	Cód	Mod	Di x	De x	Esp. x	Ha1 x	Ha2
59097	U001	510.00 x	550.00 x	— x	34.00 x	—	59143	U001	590.00 x	630.00 x	— x	34.00 x	3.00
59098	U002	510.00 x	550.00 x	— x	34.00 x	—	59144	U002	590.00 x	630.00 x	— x	34.00 x	—
—	CH	510.00 x	550.00 x	— x	89.00 x	—	59145	U001	596.00 x	640.00 x	— x	20.00 x	—
59099	U004	520.00 x	550.00 x	— x	22.00 x	—	—	CH	600.00 x	630.00 x	— x	82.00 x	—
59100	U001	520.00 x	550.00 x	— x	25.00 x	—	59146	U001	600.00 x	640.00 x	— x	20.00 x	—
59101	U002	520.00 x	550.00 x	— x	25.00 x	—	59147	U002	600.00 x	640.00 x	— x	20.00 x	—
59102	U001	520.00 x	560.00 x	— x	20.00 x	—	—	CH	600.00 x	640.00 x	— x	107.00 x	—
59103	U002	520.00 x	560.00 x	— x	20.00 x	—	59148	U004	600.00 x	650.00 x	— x	32.00 x	—
—	CH	520.00 x	560.00 x	— x	113.00 x	—	59149	U001	600.00 x	650.00 x	— x	35.00 x	—
59104	U001	520.00 x	570.00 x	— x	25.00 x	—	59150	U002	600.00 x	650.00 x	— x	35.00 x	—
59105	U002	520.00 x	570.00 x	— x	25.00 x	—	6453	CH	600.00 x	650.00 x	— x	73.00 x	—
59106	U001	524.50 x	550.00 x	— x	22.00 x	—	—	CH	600.00 x	655.00 x	— x	87.00 x	—
59107	U002	525.00 x	565.00 x	— x	34.00 x	—	3152	C	602.00 x	752.00 x	8.50 x	28.60 x	—
59108	U001	525.00 x	656.00 x	— x	34.00 x	—	—	CH	610.00 x	654.00 x	— x	96.00 x	—
52517	U	530.00 x	560.00 x	— x	25.00 x	—	3312	C	610.00 x	762.00 x	— x	28.60 x	—
59109	U004	530.00 x	565.00 x	— x	25.00 x	—	59152	U004	620.00 x	650.00 x	— x	25.00 x	—
59110	U001	530.00 x	570.00 x	— x	20.00 x	—	53206	U019	620.00 x	660.00 x	— x	19.50 x	—
59111	U002	530.00 x	570.00 x	— x	20.00 x	—	59153	U001	620.00 x	660.00 x	— x	23.00 x	—
—	CH	530.23 x	571.50 x	— x	96.00 x	—	59154	U001	625.00 x	650.00 x	— x	12.00 x	—
—	CH	533.40 x	571.50 x	— x	68.00 x	—	59155	U003	626.00 x	650.00 x	— x	16.50 x	—
59112	U002	540.00 x	580.00 x	— x	20.00 x	—	59156	U001	628.65 x	679.45 x	— x	25.40 x	—
59113	U001	545.00 x	575.00 x	— x	15.50 x	—	55664	U001	630.00 x	660.00 x	— x	25.00 x	—
59114	U002	545.00 x	575.00 x	— x	15.50 x	—	59157	U001	630.00 x	660.00 x	— x	25.00 x	—
59115	U001	545.00 x	575.00 x	— x	26.00 x	—	59158	U002	630.00 x	660.00 x	— x	25.00 x	—
59116	U002	545.00 x	575.00 x	— x	26.00 x	—	6223	CH	630.00 x	670.00 x	— x	67.00 x	—
59117	U001	550.00 x	590.00 x	— x	34.00 x	—	59159	U004	630.00 x	692.00 x	— x	34.00 x	—
59118	U002	550.00 x	590.00 x	— x	34.00 x	—	51019	U	631.80 x	660.00 x	— x	19.00 x	—
6447	CH	550.00 x	590.00 x	— x	66.00 x	—	59331	UL	637.50 x	654.50 x	6.60 x	9.60 x	13.50
59119	U001	550.00 x	600.00 x	— x	25.00 x	—	59160	U001	640.00 x	664.00 x	— x	12.00 x	—
59120	U002	550.00 x	600.00 x	— x	25.00 x	—	59161	U002	640.00 x	700.00 x	— x	30.00 x	—
F11631	J	550.00 x	600.00 x	— x	32.50 x	43.30	52796	U019	640.00 x	700.00 x	— x	30.00 x	—
53425	U	550.00 x	600.00 x	— x	40.00 x	—	52796	U019	640.00 x	700.00 x	— x	30.00 x	—
—	CH	560.00 x	588.00 x	— x	82.00 x	—	59302	U	640.00 x	700.00 x	— x	31.00 x	—
59121	U001	560.00 x	596.00 x	— x	20.00 x	—	59162	U001	642.00 x	670.00 x	— x	12.00 x	—
59122	U002	560.00 x	596.00 x	— x	20.00 x	—	59163	U002	645.00 x	670.00 x	— x	13.00 x	—
51855	U004	560.00 x	600.00 x	— x	25.00 x	—	3504	C001	647.70 x	711.20 x	— x	25.40 x	—
59123	U001	560.00 x	600.00 x	— x	34.00 x	—	—	CH	648.00 x	680.00 x	— x	60.00 x	—
59124	U002	560.00 x	600.00 x	— x	34.00 x	—	59164	U001	650.00 x	680.00 x	— x	32.00 x	—
—	CH	560.00 x	600.00 x	— x	80.00 x	—	59165	U002	650.00 x	680.00 x	— x	32.00 x	—
59125	U001	560.00 x	610.00 x	— x	42.00 x	—	59166	U001	650.00 x	690.00 x	— x	20.00 x	—
59126	U002	560.00 x	610.00 x	— x	42.00 x	—	59167	U002	650.00 x	690.00 x	— x	20.00 x	—
6415	CH	560.00 x	610.00 x	— x	50.00 x	—	8239	V	650.00 x	690.00 x	— x	21.00 x	—
50593	U	565.00 x	295.00 x	— x	25.00 x	—	—	CH	650.00 x	690.00 x	— x	78.00 x	—
59127	U001	565.00 x	605.00 x	— x	28.00 x	—	—	CH	650.00 x	690.00 x	— x	203.00 x	—
59128	U002	565.00 x	605.00 x	— x	28.00 x	—	59168	U001	650.00 x	700.00 x	— x	20.00 x	—
59129	U003	566.00 x	590.00 x	— x	16.50 x	—	59169	U002	650.00 x	700.00 x	— x	20.00 x	—
59130	U001	570.00 x	620.00 x	— x	42.00 x	—	59170	U001	660.00 x	700.00 x	— x	34.00 x	—
59131	U002	570.00 x	620.00 x	— x	42.00 x	—	59171	U002	660.00 x	700.00 x	— x	34.00 x	—
6253	CH	571.80 x	618.60 x	— x	175.00 x	—	6159	CH	660.00 x	700.00 x	— x	54.00 x	—
—	CH	574.68 x	619.13 x	— x	170.00 x	—	59172	U001	664.00 x	704.00 x	— x	32.00 x	—
59132	U001	576.00 x	600.00 x	— x	12.00 x	—	59173	U002	664.00 x	704.00 x	— x	32.00 x	—
59133	U002	576.00 x	620.00 x	— x	20.00 x	—	59174	U001	664.00 x	704.00 x	— x	34.00 x	—
59134	U001	578.00 x	590.00 x	— x	6.00 x	—	59175	U002	664.00 x	704.00 x	— x	34.00 x	—
59135	U002	578.00 x	590.00 x	— x	6.00 x	—	59177	U001	669.00 x	710.00 x	— x	20.00 x	—
59136	U001	578.00 x	618.00 x	— x	16.00 x	—	59176	U001	669.00 x	710.00 x	— x	20.00 x	—
59137	U002	578.00 x	618.00 x	— x	16.00 x	—	59178	U002	669.00 x	710.00 x	— x	20.00 x	—
59138	U001	579.00 x	620.00 x	— x	20.00 x	—	59179	U001	669.00 x	710.00 x	— x	25.00 x	—
59139	U003	580.00 x	600.00 x	— x	10.00 x	—	59180	U002	669.00 x	710.00 x	— x	25.00 x	—
59140	U001	580.00 x	620.00 x	— x	25.00 x	—	59181	U001	676.00 x	700.00 x	— x	12.00 x	—
59141	U002	580.00 x	620.00 x	— x	25.00 x	—	59182	U002	676.00 x	700.00 x	— x	12.00 x	—
52502	U	580.00 x	630.00 x	— x	25.00 x	—	3538	C	697.50 x	761.00 x	— x	31.70 x	—
52502	U	580.00 x	630.00 x	— x	25.00 x	—	59183	U001	700.00 x	740.00 x	— x	20.00 x	—
59142	U001	580.00 x	630.00 x	— x	25.00 x	—	59184	U002	700.00 x	740.00 x	— x	20.00 x	—
—	CH	580.00 x	630.00 x	— x	101.00 x	—	6418	CH	700.00 x	740.00 x	— x	473.41 x	—
3259	C	584.20 x	660.40 x	— x	26.20 x	—	—	CH	704.85 x	749.30 x	— x	78.00 x	—
52653	U	585.00 x	605.00 x	— x	18.00 x	—	50723	U	709.50 x	750.80 x	— x	35.00 x	—
3493	C	587.40 x	674.00 x	— x	20.60 x	—	59185	U001	710.00 x	750.00 x	— x	44.00 x	—





Cód	Mod	Di x	De x	Esp. x	Ha1 x	Ha2	Cód	Mod	Di x	De x	Esp. x	Ha1 x	Ha2
59186	U002	710.00 x	750.00 x	— x	44.00 x	—	59205	U001	800.00 x	850.00 x	— x	42.00 x	—
—	U	711.20 x	736.60 x	— x	19.05 x	—	59206	U002	800.00 x	850.00 x	— x	42.00 x	—
59187	U001	715.00 x	739.00 x	— x	12.00 x	—	8368	V	801.50 x	836.00 x	— x	17.25 x	—
59188	U001	725.00 x	775.00 x	— x	25.00 x	—	59207	U019	818.00 x	848.00 x	— x	18.00 x	—
59189	U002	725.00 x	775.00 x	— x	25.00 x	—	59209	U002	822.30 x	850.90 x	— x	19.05 x	—
59190	U001	726.00 x	750.00 x	— x	12.00 x	—	59210	U001	850.00 x	882.00 x	— x	18.00 x	—
8416	V	735.00 x	761.00 x	— x	21.50 x	—	59211	U002	850.00 x	882.00 x	— x	18.00 x	—
—	CH	750.00 x	800.00 x	— x	114.00 x	—	59212	U004	850.00 x	900.00 x	— x	35.00 x	—
50817	U001	752.00 x	778.40 x	— x	19.05 x	—	59213	U001	865.00 x	895.00 x	— x	15.00 x	—
59191	U001	755.00 x	791.00 x	— x	20.00 x	—	59214	U003	876.30 x	914.40 x	— x	25.40 x	—
59192	U002	755.00 x	791.00 x	— x	20.00 x	—	59215	U001	880.00 x	920.00 x	— x	20.00 x	—
59193	U001	760.00 x	800.00 x	— x	34.00 x	—	3556	C	895.35 x	1003.30 x	— x	31.75 x	—
59194	U002	760.00 x	800.00 x	— x	34.00 x	—	59216	U004	900.00 x	950.00 x	— x	35.00 x	—
52036	U001	762.00 x	787.00 x	— x	19.50 x	—	59217	U002	911.20 x	939.80 x	— x	19.05 x	—
59195	U001	763.00 x	775.00 x	— x	6.00 x	—	52705	U	965.20 x	1009.65 x	— x	36.00 x	—
59196	U002	763.00 x	775.00 x	— x	6.00 x	—	59218	U001	988.00 x	1000.00 x	— x	6.00 x	—
59197	U004	770.00 x	810.00 x	— x	20.00 x	—	59219	U002	988.00 x	1000.00 x	— x	6.00 x	—
59199	U004	770.00 x	820.00 x	— x	35.00 x	—	53493	U	998.00 x	1042.00 x	— x	32.00 x	—
—	CH	780.00 x	830.00 x	— x	99.50 x	—	59220	U001	1000.00 x	1042.00 x	— x	34.00 x	—
59200	U001	798.00 x	840.00 x	— x	20.00 x	—	59221	U002	1000.00 x	1042.00 x	— x	34.00 x	—
59201	U002	798.00 x	840.00 x	— x	20.00 x	—	59224	U001	1010.00 x	1050.00 x	— x	20.00 x	—
6390	CH	798.15 x	839.35 x	— x	— x	—	53237	U002	1138.00 x	1169.00 x	— x	12.00 x	—
8370	V	798.15 x	839.35 x	— x	18.00 x	—	53492	U	1138.00 x	1169.00 x	— x	32.00 x	—
59202	U001	800.00 x	840.00 x	— x	34.00 x	—	51896	U	1180.00 x	1250.00 x	— x	40.00 x	—
59203	U002	800.00 x	840.00 x	— x	34.00 x	—	6157	CH	1270.00 x	1314.45 x	— x	82.55 x	—
59204	U004	800.00 x	840.00 x	— x	35.00 x	—							



INCOVE VEDAÇÕES LTDA.

**ANéis**



## ANÉIS O

O anel O é o mais versátil de todos os vedadores, com a vantagem especial de simplicidade e baixo custo. É adequado tanto para vedação estática como dinâmica em quase todos os campos de aplicação, dentro dos limites de desempenho do vedador e das características do material. O sucesso do uso de anéis O depende contudo da montagem ou instalação adequada e de se dar a devida consideração às limitações que possam ser importantes na aplicação visada.

A memória mais antiga do uso de vedação por meio de anéis O remonta a mais de um século, quando um anel de seção circular de ferro fundido inteiriço foi experimentado como vedador de pistão e uma máquina a vapor. O anel O elástico apareceu um pouco mais tarde no mesmo século, aplicado como vedador em uma torneira de água. Entretanto, foi só por ocasião da Segunda Guerra Mundial que se difundiu amplamente o uso do anel O (em grande parte nos estados Unidos), os tamanhos foram padronizados, seu número foi aumentado e as aplicações do anel O começaram a expandir-se enormemente. Basicamente, um selo de anel O compreende um anel O (geralmente de borracha ou outro elastômero) preso em uma cavidade onde colocado. Esses selos podem ser feitos completamente à prova de vazamento para aplicações estáticas até pressões extremamente altas; satisfatoriamente à prova de vazamento para aplicações dinâmicas e pressões de fluido até  $350 \text{ kgf/cm}^2$ , dentro de determinados limites de operação. Se esses selos forem corretamente projetados e aplicados, eles serão de extrema confiança, em razão de sua simplicidade e robustez básicas. É geralmente interessante examinar a possibilidade de seu uso como uma alternativa simples e de baixo custo para a maioria das aplicações, excetuando-se os selos dinâmicos de alta pressão, selos rotativos com velocidade de deslizamento superiores a  $450 \text{ m/min}$  e selos dinâmicos de serviços mais pesados. Não se pode concluir necessariamente, contudo, que por ser um anel O adequado para determinada aplicação seu desempenho será superior ao de um tipo alternativo de vedador.

Os anéis O são geralmente moldados em materiais semelhantes à borracha, sendo as nitrílicas as mais comuns para serviços gerais e

de óleo. O polímero básico pode ser escolhido, quando necessário em função de sua compatibilidade com o fluido ou o serviço visado. Para serviços que estejam fora do campo dos elastômeros, podem ser empregados anéis metálicos, embora eles tenham uma aplicação mais específica e sejam usados restritamente para vedação estática. O desempenho do anel O é afetado também pela dureza da borracha. Um material mais macio (de dureza  $60^\circ \text{ IRH}$  aproximadamente.) oferecerá melhor vedação em baixas pressões, ao passo que um material mais duro (dureza  $90^\circ \text{ IRH}$ ) dará maior estabilidade em serviços de alta pressão. A faixa típica de dureza dos anéis O de borracha é portanto  $60-90^\circ \text{ IRH}$ , sendo  $70-75^\circ \text{ IRH}$  para os serviços gerais, oferecendo esta a máxima resistência à abrasão e ao desgaste. Outros fatores diretamente relacionados com o atrito e o desgaste estão reunidos na Tabela 6-II. Deve-se também ter em mente que, para serviços em temperaturas extremas, pode-se modificar a dureza original do anel, com efeitos semelhantes.

O princípio de vedação de um anel O é apresentado esquematicamente abaixo.

Ao ser montado em sua ranhura, o anel é submetido a um aperto ou mordedura inicial dependente dos tamanhos relativos do anel, da profundidade da ranhura e da folga diametral. Isso fornece uma pressão de vedação inicial. A pressão interna subsequente, aplicada através do vão de folga sobre um lado do anel O, deforma-o de encontro à extremidade oposta da ranhura, transmitindo-se essa pressão às superfícies a vedar. A pressão de vedação



Princípio de vedação de um anel O



é assim realmente mais elevada que a pressão de fluido aplicada, no valor da pressão de interferência inicial. A eficiência desse tipo de selo depende muito da forma geométrica inicial. Aumentando a pressão, a deformação do anel exagerar-se-á, tendendo no caso extremo a provocar extrusão de uma seção do anel em direção ao vão da folga. Se o vão da folga for suficientemente grande, o anel poderá falhar completamente por extrusão sob pressão estática moderada; ou, alternativamente, se a pressão estática for suficientemente elevada, o anel finalmente falhará por extrusão através de qualquer vão de folga. No caso de aplicações dinâmicas, qualquer tendência à extrusão fará obviamente com que o desgaste se localize no anel O e provocará sua falha prematura. Basicamente, portanto, existem limites definidos para a pressão interna, tanto em aplicações estáticas como dinâmicas, e que são controlados pelo vão da folga e pela dureza do anel O. Na prática, a folga é normalmente especificada para um dado tamanho de anel e uma dada aplicação, estabelecendo-se um limite de pressão para determinada (ou típica) dureza do anel. Isso porém, só pode ser apresentado como um valor de projeto. Nas condições reais de trabalho, o vão de folga usual calculado pode ser modificado pela expansão ou pela contração dos elementos participantes causada por variação de temperatura ou de pressão. A subestimação desse fator pode acarretar problemas de extrusão. Assim, para operação em baixas temperaturas, pode ser necessário reduzir a profundidade da ranhura de modo a permitir a contração do anel e a obter-se o aperto requerido no tamanho contraído. Analogamente, em serviços de altas temperaturas, pode ser aconselhável aumentar ligeiramente a profundidade da ranhura para evitar aperto excessivo do anel expandido na temperatura de trabalho. Esse efeito pode ser importante em extremos de temperatura, visto que o coeficiente de dilatação térmica dos elastômeros é sensivelmente superior ao dos metais. Um efeito da pressão por vezes subestimado é a possibilidade de que um elemento externo, tal como um cilindro, se dilate ligeiramente pela pressão ou por um aumento momentâneo de pressão, aumentando o vão da folga e assim favorecendo a extrusão do anel. Em casos extremos, pode ser necessário reforçar o elemento para evitar esse efeito.

## Anéis de Apoio

Para evitar a possibilidade de extrusão — e, especificamente, para aumentar a capacidade de pressão do selo de anel O — pode-se introduzir um anel de apoio destinado a fechar o vão da folga. Ele é colocado na ranhura no lado do anel O, oposto à pressão aplicada; ou em ambos os lados quando o anel O deve vedar pressões provenientes de ambos os sentidos. Aumenta-se correspondentemente a largura da ranhura para acomodar o anel ou os anéis de apoio.

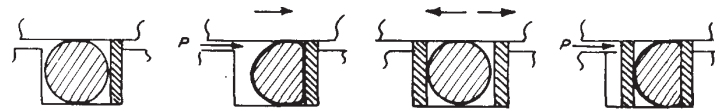

## Anéis de apoio (anfiextrusão) planos

Um anel de apoio nada mais é que um anel de material mais duro e diâmetro adequado para encaixar na ranhura e fechar o vão da folga. Diversos materiais podem ser usados para os anéis de apoio, tais como couro, borracha dura e PTFE, sendo o último especialmente preferido para os tamanhos pequenos e tendo a vantagem de oferecer um atrito muito baixo em aplicações dinâmicas. A principal exigência em relação a um anel de apoio é que não sofra colapso ou deformação a frio, o que por sua vez depende grandemente de usar-se um anel de tamanho adequado juntamente com ranhura de dimensões adequadas. A maioria dos anéis de apoio é plana, mas também podem ser empregados anéis de perfil especial adaptado à forma dos anéis O.

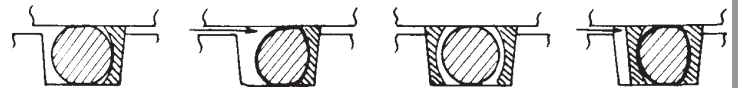

Anéis de apoio (antiextrusão) encurvados de apoio não possuam cortes inclinados ou outras formas construtivas que possam causar enfraquecimento local e, conseqüentemente, colapso ou permitam extrusão dos anéis O em irregularidades da superfície, que poderiam provocar mordedura ou agarramento dos anéis. Sob esse ponto de vista, os anéis de apoio de perfil especial são considerados superiores aos planos, principalmente para aplicações de pressão mais elevada.





Os requisitos da ranhura são basicamente simples. As dimensões principais são relacionadas com o tamanho do anel e com a aplicação e, embora idealmente seja preferível uma ranhura de forma retangular, permite-se um ângulo de saída de 5° para facilidade de usinagem. Recomenda-se geralmente um raio de 0,50 a 0,75 mm nas arestas internas, ao passo que as arestas superiores devem ser quebradas com um pequeno raio para evitar qualquer possibilidade de apresentarem um gume. Esse raio deve manter-se pequeno (0,12 a 0,25 mm) para não favorecer a extrusão. (V. também a norma BS 1806.)

O acabamento superficial da ranhura é importante por sua influência sobre o desgaste e a vida do vedador, se bem que as exigências não sejam muito severas. A norma BS 2634 recomenda um acabamento mais fino que 0,8 /n,m Ra. Não é necessário um acabamento ultrafino, mas evidentemente as rebarbas, os arranhões e as marcas de usinagem aparentes devem ser removidas. O acabamento da superfície em que desliza o anel O nas aplicações dinâmicas (por exemplo: hastes ou superfícies internas dos cilindros) deve ser de ordem superior, preferivelmente mais fino de 0,4 /mi Ra (BS 2634). A superfície deve ser também isenta de riscos longitudinais e marcas de usinagem ou de vibração. As marcas periféricas podem ser aceitáveis, mas devem ser evitadas se possível. O espelhamento, a retificação o polimento ou a cromação dura são acabamentos recomendados para obtenção de vida máxima dos anéis O em aplicações dinâmicas. Em aplicações estáticas, é aceitável um acabamento superficial muito mais áspero (0,8 a 1,3 /unRa), sendo desejável o menor desses valores para os trabalhos de alta pressão. Uma das vantagens do uso de anéis O para vedação estática é que eles são eficientes com acabamentos superficiais muito mais ásperos, e portanto mais baratos, do que os exigidos pelas juntas. Os materiais que estão em contato com o anel O também têm influência sobre sua vida. Em geral devem ser evitados nas aplicações dinâmicas os metais mais macios, tais como o alumínio, o latão e o bronze, se bem que possam ser adequados para serviços de baixa pressão. O aço inoxidável e o monel são outros dois materiais que geralmente se prefere evitar em aplicações dinâmicas de anéis O, embora também aqui haja exceções.

A lubrificação é outro fator de alguma importância. Em muitas aplicações dinâmicas, o anel O é lubrificado pelo próprio fluido com que está em contato e pode ser lubrificado com o mesmo fluido para facilitar a montagem inicial. Quando o fluido não possui propriedades lubrificantes, é necessário lubrificar positivamente o anel O, pois o desgaste de vedadores secos será muito grande. O mesmo se aplica à montagem inicial. Todas as peças metálicas que irão ter contato com o anel O, e o próprio vedador, devem ser previamente lubrificadas. Isso se aplica tanto aos selos estáticos como aos dinâmicos.

Para aplicações gerais, a lubrificação por meio de untura do anel O e da ranhura com uma graxa de alto ponto de fusão é geralmente adequada. Em aplicações específicas, pode ser necessário usar um lubrificante compatível com o sistema e o serviço visados. A compatibilidade entre o material do anel O e o fluido com o qual estará em contato é um dos principais fatores que afetam sua seleção, mas um ponto de certa importância é que, mesmo quando se verifica ser compatível o material do anel O, ele pode sofrer variação de volume quando imerso no fluido. Isso pode influir sobre o aperto efetivo.

### Oil Selos Estáticos

Os selos estáticos podem ser definidos como fechados em que as contrapartes não estão sujeitas a movimento relativo, a não ser pequenos afastamentos eventuais produzidos pela pressão do fluido.

Em geral os anéis O podem ser usados com ranhuras de dimensões padronizadas, para vedar pressões até 100kgf/cm<sup>2</sup>, com um aperto de 15-30% segundo a seção transversal do anel O. Entretanto, onde seja possível a presença de vibrações ou flutuações de pressão, pode ser necessário fechar o vão da folga ou empregar anéis de apoio para evitar a possibilidade de extrusão do anel. Alguns desses métodos precisam ser usados para vedar pressões superiores a 100kgf/cm<sup>2</sup> com anéis O elastoméricos.

Pelo menos teoricamente, a capacidade de pressão de um selo estático de anéis O aumentará à medida que se feche o vão da folga. Se as superfícies das contrapartes forem razoavelmente lisas e puderem ser aproximadas até um contato praticamente metal contra metal, pressões





extremamente elevadas poderão ser vedadas sem que se precise recorrer aos anéis de apoio, uma vez que o vão da folga estará eliminado. Pressões da ordem de 7.000 a 14.000 kgf/cm<sup>2</sup> têm sido vedadas dessa maneira. Sendo impossível um fechamento perfeito ou havendo a possibilidade de que as superfícies respirem, pode-se recorrer aos anéis de apoio para aplicações de alta pressão.

Para a vedação de ar e gases, deve-se investigar a permeabilidade do elastômero empregado. Isso é particularmente importante no caso de selos estáticos de anéis O em sistemas de vácuo, em que pode também ser necessário um projeto especial de ranhura para acomodar a contração da borracha e a relutância das borrachas em vedar sob pressões muito baixas. É geralmente necessário procurar que a seção do anel O ocupe toda a seção da ranhura para evitar qualquer movimento do vedador, o que poderia provocar um bombeamento indesejável ou perda de assento.

Os selos convencionais de flanges, do tipo de juntas etc., não apresentam problemas especiais. A ranhura pode ser aberta em qualquer um dos componentes e o aperto necessário pode ser aplicado pelos parafusos de aperto, devendo-se assegurar que seja aplicado uniformemente em toda a periferia do anel. Os tampões e uniões podem ser vedados de modo semelhante ou então o anel pode ser montado em uma ranhura na peça fêmea ou na peça macho, de modo a ser apertado radialmente quando se montam as duas partes.

Basicamente o diâmetro máximo da ranhura deve ser feito igual ao diâmetro externo do anel quando a pressão é aplicada da parte interna, pois isso elimina o movimento do anel quando pressurizado e evita o desgaste abrasivo e mesmo o bombeamento. Também é um bom procedimento, quando prático, aplicar a pressão do sistema para fechar o vão da folga.

## Vedadores Comprimidos

Uma outra alternativa consiste na eliminação total da ranhura e apoiar o anel O contra uma flange ou um rebordo e aplicar o aperto por meio de uma borda chanfrada situada na contraparte. É o que se chama um vedador comprimido. A extremidade da região cônica da peça macho deve ser ligeiramente menor (cerca de 10%) do

que o diâmetro interno do anel O selecionado quando uma conicidade de 45° proporcionar normalmente um volume de alojamento adequado. Se assim for preferido, o volume do alojamento poderá ser calculado, tomando-se seu valor como 0,9 vezes o volume do anel O. Uma vez usado como vedador comprimido, o anel O fica deformado permanentemente.

Certos tipos de selos estáticos, tais como os de assentos de válvulas, requerem uma forma modificada da ranhura para evitar a possibilidade de arrancamento. Isso pode ocorrer em pressões relativamente baixas quando a força efetivamente criada pela pressão do fluido, sob certas condições ou em certas posições do conjunto, é dirigida radialmente para o exterior e levanta o anel para fora de uma ranhura convencional. Outra causa possível é a infiltração de gás no anel O, que pode fazê-lo inchar ou flutuar momentaneamente durante baixas de pressão e saltar para fora da ranhura. A solução mais simples nesses casos consiste geralmente em empregar uma forma de ranhura que impeça mecanicamente o movimento radial do anel O dirigido para fora. Como alternativa, pode ser possível ventilar a ranhura de modo que seja sempre aplicada uma diferença de pressão negativa no diâmetro interno do anel O, em condições que poderiam de outro modo provocar seu arrancamento.

## Selos de Assento

Um outro tipo de aplicação dos anéis O em selos estáticos é o selo de assento, onde o anel O é usado como uma arruela de vedação sobre a face de uma peça que se fecha contra outra. A vedação é produzida pela distorção do anel O provocada pela pressão de fechamento, que assim forma um selo contra a superfície. O grau de distorção é governado pela dureza do material do anel e pela pressão de fechamento.

Essa mesma forma de instalação de anel O pode também ser usada mais com o intuito de absorver choques do que propriamente de vedar; ou pode combinar as duas funções, produzindo um selo de assento capaz de absorver choques. A montagem é simples e direta, mas o projeto da ranhura ou do elemento de retenção deve ser tal que o anel O fique preso e não possa sair da posição, embora



permita ainda que uma parte suficiente da seção se projete para fora, criando assim a distorção e o contato facial necessários à vedação e à absorção de choques.

Quando usado como um selo dinâmico, o anel O fica sujeito a uma ação de deslizamento que pode incluir movimentos alternativos ou rotativos ou uma combinação de ambos. Nos movimentos de deslizamento em que o anel O está montado perpendicularmente à direção do movimento, o anel pode também estar sujeito a rolamento. Como o desempenho vai depender das condições reais encontradas, as aplicações serão melhor descritas em tópicos separados.

## Selos Alternativos

Tanto o deslizamento como o rolamento podem ocorrer em um selo alternativo, constituindo um exemplo típico o selo pistão/cilindro. Os anéis O são mais adequados para aplicações de pequeno diâmetro, pequeno curso e pressões moderadas, embora não seja excluído seu uso em outros sistemas. Um fator bem mais importante a considerar é que os anéis O não são especialmente adequados para selos alternativos de velocidade muito baixa, principalmente porque o atrito nessas condições tende a ser alto, acarretando falha prematura do vedador. O desempenho satisfatório em qualquer aplicação alternativa depende também de empregar-se um selo dentro de sua capacidade e com instalação adequada. Basicamente o aperto é necessário apenas para compensar diferenças de expansão ou contração e assegurar vedação em pressões muito baixas ou temperaturas baixas, embora isso por sua vez dependa do tipo de elastômero usado. Um aperto excessivo serviria apenas para produzir atrito e desgaste excessivos e poderia também provocar falha helicoidal.

A falha helicoidal é causada por condições que permitem que algumas partes do anel deslizem e outras rolem simultaneamente. Daí resulta uma torção excessiva do anel capaz de levá-lo à ruptura, que se apresenta na forma de um corte helicoidal apertado, em torno do anel, quando este é removido, embora o anel possa continuar a vedar satisfatoriamente até a ocorrência da ruptura.

Corretamente instalado e operando em condições adequadas, um anel O não deve normalmente tender a

rolar ou torcer-se em movimentos alternativos, uma vez que sua área de contato com a ranhura é maior que a área de contato por deslizamento com a superfície deslizante e que a própria seção do anel resiste intrinsecamente à torção. A disposição das forças de atrito também tende a manter o anel estacionário em sua ranhura (o atrito estático é maior que o atrito de deslizamento) e por outro lado o acabamento superficial da ranhura é geralmente mais áspero que o da superfície deslizante.

Fatores capazes de alterar esse sistema podem conduzir a falhas helicoidais, como por exemplo o excessivo atrito de deslizamento devido ao excessivo aperto ou falta de lubrificação; uma forma insatisfatória de ranhura, que permita livre rolamento do anel ou redução da área de contato; altas temperaturas, produzindo aumento de aperto e atrito; superfície de deslizamento com acabamento de má qualidade ou danificado, produzindo atrito e desgaste irregulares; excentricidade; a presença de cargas laterais ou de flexão; e assim por diante.

Quando a falha helicoidal chega a correr realmente, a causa imediata é mais provavelmente uma combinação de fatores do que um fator individual mas a causa fundamental é a torção do anel.

Pressões de serviço de até 100kgf/cm<sup>2</sup> podem ser vedadas com uso de ranhuras. Para pressões mais altas, é necessário prever anéis de apoio e modificar correspondentemente a largura da ranhura. O emprego de anéis de apoio permite geralmente a vedação de pressões de 350 a 420 kgf/cm<sup>2</sup>, ou mais elevadas, mediante criteriosa seleção de material e mais rigorosa observância das tolerâncias. No caso de pressões de serviço acima de 100kgf/cm<sup>2</sup> e selos alternativos de anéis O, é costume consultar o fabricante dos anéis sobre recomendações específicas.

Dentro do possível, deve-se prever o funcionamento do vedador de modo tal que a pressão e o atrito de deslizamento ajam em direções opostas. Se os dois agirem na mesma direção, a tendência à extrusão do anel O seria muito mais acentuada e poderia reduzir substancialmente sua capacidade de pressão. Se a ranhura não puder ser localizada de forma a poder inverter a direção do atrito, então poder-se-ia usar vantajosamente um anel de apoio em pressões de 70 a 100 kgf/cm<sup>2</sup>. Os anéis de apoio



também contribuem para uma boa lubrificação do anel O.

As pressões de choque podem ser especialmente danosas, pois a pressão instantânea pode atingir valores várias vezes maiores que o valor da pressão máxima normal do sistema, com diferentes possibilidades de dano ao vedador. Também isso pode ser evitado pela adoção de um ou mais anéis de apoio; ou então pelo uso de travas mecânicas ou pela instalação de uma válvula de alívio no sistema do fluido.

Frequentemente não se imagina que uma baixa pressão possa ser tão danosa como uma pressão excessiva, principalmente se acompanhada de vazamento lento. Isso pode produzir um resultado equivalente ao de um movimento muito lento com grande atrito, quanto ao anel O, podendo causar torção e falha helicoidal. Na realidade, uma pressão acima de 35 kgf/cm<sup>2</sup> tende geralmente a eliminar qualquer torção do anel O.

Para movimentos alternativos de pequeno curso, geralmente se preferem os anéis O, pois eles reduzem ao mínimo as cargas laterais e de flexão, bem como a excentricidade do sistema móvel, qualquer uma das quais resultaria em altas cargas unitárias. Outro modo de abordar o problema consistiria no emprego de um alojamento flutuante ou de uma superfície metálica de apoio definida.

Um alojamento flutuante típico, aplicado tanto ao pistão como à haste. Isso proporciona um grau de flexibilidade ou flutuação suficiente para compensar qualquer excentricidade ou desalinhamento por meio de uma solução relativamente simples e econômica. Evita-se o contato metálico e eliminam-se grandes cargas de apoio. A mesma figura mostra uma solução alternativa em que tanto o pistão como a haste são providos de mancais de metal branco e os anéis O são mantidos para fins de vedação. Isso oferece uma disposição especialmente adequada para serviços pesados ou de alta pressão

(nesse caso os anéis O devem ser usados juntamente com anéis de apoio).

Os trabalhos em baixas temperaturas apresentam um problema especial para os selos alternativos de anéis O, pois a contração dos anéis na temperatura de serviço pode ser considerável e a redução da folga para compensar

essa contração poderá provocar contato metálico de deslizamento.

A adoção de um material de mais baixa contração para o anel O ou o aumento do aperto constituem as soluções mais simples para eliminar vazamentos em temperaturas muito baixas, embora o tensionamento do anel por meio de mola possa ser uma solução melhor.

Deve-se ter em mente, contudo, que em selos alternativos destinados a vedar líquidos, geralmente é desejável um pequeno vazamento, pois isso indica que o vedador não está trabalhando em seco, condição em que o atrito e o desgaste podem ser grandes.

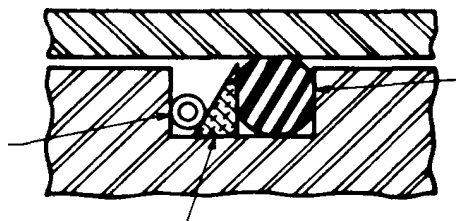

## Anel

**Cunha de metal mole— Selo de Anel O tensionado por mola**

## Selos Rotativos

### Pressão

Embora isso não seja recomendado genericamente por algumas autoridades, os anéis O podem servir como selos rotativos de modo perfeitamente satisfatório para velocidades de deslizamento de até 450 m/s, dentro de suas limitações. Entretanto, as condições de projeto necessárias a um bom desempenho são críticas, principalmente a folga, o empuxo lateral e o jogo axial.

Localizar o selo o mais próximo possível do fluido lubrificante

### **Dados para Aplicação de Anéis O em Serviços Rotativos**

Especificamente, é necessário que o anel O seja instalado em uma ranhura aberta na contraparte do eixo rotativo, isto é, na bucha ou elemento fixo dentro do qual ele gira. Se a ranhura estiver no eixo, o anel O tenderá a expandir-se enquanto o eixo gira e a sofrer grande desgaste causado pelo atrito de deslizamento em relação à ranhura.



O mesmo se aplica a outras aplicações rotativas. A ranhura do anel O deve ficar situada no elemento estacionário. É importante então que essa ranhura ou dispositivo de retenção mantenha o anel preso sem tensão por atrito ou causa semelhantes, pois se aquecido tensionado o anel tenderá a contrair-se. Isso poderia fazê-lo aderir ao eixo, embora essa possibilidade não exista sempre com velocidades periféricas abaixo de 60 m/s.

Para reduzir o atrito e o desgaste ao mínimo, o anel O deverá ser usado apenas como elemento de vedação, empregando-se superfícies de apoio separadas para suportar as cargas mecânicas. Isso capacitará o anel O a trabalhar com o aperto estritamente necessário a um desempenho satisfatório como vedador. Por outro lado, isso confere importância especial às tolerâncias do eixo e dos mancais para a eliminação de excentricidade. A manutenção de selos de anéis O de eixos rotativos pode tornar-se incomoda ou impossível quando a excentricidade ultrapassa aproximadamente 0,01 mm.

O tamanho da ranhura é projetado para evitar rotação do vedador e, como regra geral, obtém-se o desempenho mais satisfatório com a menor seção do anel O (caracterizada por seu diâmetro) disponível para o diâmetro do selo requerido — embora geralmente isso não seja crítico para velocidades periféricas abaixo de 60 m/min. Para velocidades periféricas de 60 a 120 m/min, recomenda-se um diâmetro máximo da seção transversal de 3,53 mm; passando a 2,62 mm para maiores velocidades ou ainda menos (1,78 mm) para velocidades acima de 180 m/min.

O desempenho satisfatório de um anel O como vedador em serviço rotativo depende quase inteiramente de sua temperatura de trabalho. Independentemente do material escolhido, não é provável que seja adequado para temperaturas abaixo de  $-30^{\circ}\text{C}$  ou acima de  $95^{\circ}\text{C}$ , especialmente com velocidades periféricas mais elevadas. Também se deve levar em consideração o fato de que o anel O recebe calor dos mancais adjacentes bem como calor produzido pelo atrito, requerendo o maior distanciamento possível do mancal em relação ao anel O, ou, se isso for impraticável, o uso de mancais de comprimento adequado para promover a dissipação do calor.

Em alguns casos pode ser desejável, ou mesmo necessário, tensionar elasticamente um vedador rotativo para obter-se vedação satisfatória. Dois métodos simples são apresentados, usando-se, respectivamente, um anel de apoio de borracha mole e um anel O mole. Qualquer desses dois métodos é preferível ao uso de uma mola de tipo mecânico.

## Selos Oscilantes

Um selo oscilante distingue-se de um selo rotativo pelo fato de que lá os elementos móveis descrevem um arco em um sentido de rotação e em seguida no sentido oposto e não um movimento rotativo contínuo. Essa oscilação pode ser acompanhada ou não de movimento de deslizamento ou longitudinal, mas isso geralmente pode ser ignorado para fins de projeto do selo.

Para velocidades periféricas abaixo de 60 m/min, os requisitos das ranhuras podem ser considerados como os mesmos estabelecidos para selos alternativos de anéis O (Tabela 6-VI). Para velocidades maiores (que constituem minoria), pode ser necessário considerar o anel O como um selo rotativo. As mesmas considerações aplicam-se quando a oscilação se realiza em movimento ininterrupto, embora nesse caso as exigências sejam geralmente muito menos rigorosas que as dos verdadeiros selos rotativos.

## Selos Pneumáticos

Os selos pneumáticos são geralmente incluídos em uma classificação separada, embora eles possam utilizar formas padronizadas de selos estáticos, rotativos e alternativos, principalmente por causa da natureza diversa do fluido vedado. Os principais problemas adicionais encontrados são a falta de poder lubrificante do ar, que pode tornar difícil manter um vedador lubrificado sem um sistema de lubrificação separado, como a névoa de óleo; a permeabilidade dos elastômeros ao ar; a ação deteriorante do oxigênio do ar sobre os materiais dos vedadores; a rápida variação de volume e a alta velocidade de operação dos cilindros pneumáticos etc.; e a possibilidade de uso em temperaturas mais elevadas que as normalmente aplicáveis aos líquidos. Este último aspecto é especialmente importante porque os elastômeros são sensivelmente menos resistentes ao calor seco do que ao calor úmido. Quanto a essa propriedade,





a borracha silicônica constitui a principal exceção, embora se ressinta de má resistência ao corte e à abrasão.

## Conclusão

A escolha do elastômero para selos hidráulicos é, portanto, especialmente importante, sobretudo em aplicações onde possa haver completa falta de lubrificação (fora a aplicada inicialmente) ou serviço em alta temperatura. Também pode ser necessário modificar as dimensões da ranhura e da folga em relação às recomendadas para selos alternativos ou rotativos normais, e nesse caso devem ser seguidas as recomendações do fabricante de anéis O.

Cód.	Di x Esp.	Cód.	Di x Esp.	Cód.	Di x Esp.	Cód.	Di x Esp.	Cód.	Di x Esp.
31551	0.74 x 1.02	31602	2.84 x 2.62	33662	3.96 x 1.58	34847	5.00 x 2.00	32892	6.00 x 3.00
31551	0.74 x 1.02	31556	2.90 x 1.78	33662	3.96 x 1.58	30209	5.00 x 2.50	34135	6.00 x 3.80
31552	1.07 x 1.27	31556	2.90 x 1.78	34833	3.97 x 1.19	30209	5.00 x 2.50	34539	6.00 x 4.00
31552	1.07 x 1.27	30057	2.90 x 1.78	34834	3.97 x 1.59	32934	5.00 x 2.70	34860	6.00 x 5.00
34811	1.15 x 1.00	30059	2.90 x 1.78	32211	4.00 x 1.00	30341	5.00 x 3.00	34861	6.00 x 5.50
34812	1.19 x 1.00	31556	2.90 x 1.78	33188	4.00 x 1.00	30341	5.00 x 3.00	33002	6.02 x 2.62
34813	1.24 x 2.62	30003	3.00 x 1.00	33188	4.00 x 1.00	30341	5.00 x 3.00	31604	6.02 x 2.62
34814	1.24 x 2.62	36942	3.00 x 1.00	32194	4.00 x 1.18	34848	5.00 x 3.20	31604	6.02 x 2.62
33760	1.30 x 1.50	32656	3.00 x 1.50	30014	4.00 x 1.50	34849	5.00 x 4.00	32806	6.07 x 1.63
31553	1.42 x 1.52	33765	3.00 x 1.50	30014	4.00 x 1.50	34850	5.10 x 2.00	30060	6.07 x 1.78
31553	1.42 x 1.52	32656	3.00 x 1.50	30014	4.00 x 1.50	33792	5.20 x 1.00	31560	6.07 x 1.78
33207	1.50 x 0.60	33422	3.00 x 1.75	33835	4.00 x 1.80	34851	5.20 x 2.30	30060	6.07 x 1.78
36953	1.50 x 0.75	30053	3.00 x 1.75	34746	4.00 x 1.80	30814	5.20 x 3.75	32197	6.07 x 1.78
36389	1.50 x 1.78	33422	3.00 x 1.80	30105	4.00 x 2.00	32235	5.23 x 2.62	31560	6.07 x 1.78
33618	1.50 x 1.90	33422	3.00 x 1.80	30105	4.00 x 2.00	34852	5.23 x 2.62	30060	6.10 x 1.60
34259	1.50 x 2.00	34823	3.00 x 1.90	30207	4.00 x 2.50	34852	5.23 x 2.62	34862	6.14 x 4.18
33523	1.58 x 1.00	30102	3.00 x 2.00	32492	4.00 x 2.50	31559	5.28 x 1.78	30008	6.25 x 1.20
33489	1.70 x 1.00	30102	3.00 x 2.00	32691	4.00 x 3.00	30058	5.28 x 1.78	34107	6.30 x 1.50
36954	1.78 x 1.02	34482	3.00 x 2.50	34835	4.20 x 1.20	31559	5.28 x 1.78	34107	6.30 x 1.50
31554	1.78 x 1.78	34482	3.00 x 2.50	30106	4.20 x 2.00	_____	5.30 x 2.40	34107	6.30 x 1.50
31554	1.78 x 1.78	34676	3.00 x 2.80	34836	4.30 x 1.00	30200	5.40 x 2.40	33619	6.30 x 1.90
36445	1.80 x 0.70	30011	3.20 x 1.40	33683	4.30 x 1.85	32622	5.40 x 2.40	30180	6.30 x 2.30
33591	1.80 x 1.10	33165	3.20 x 1.40	32903	4.30 x 1.85	32177	5.50 x 1.00	34863	6.30 x 2.40
33347	1.90 x 1.00	34824	3.20 x 1.50	32195	4.30 x 2.40	32177	5.50 x 1.00	34864	6.30 x 2.40
30007	1.98 x 1.19	34825	3.20 x 2.40	32519	4.34 x 3.53	36910	5.50 x 1.50	34865	6.30 x 3.20
_____	1.98 x 1.59	32243	3.30 x 1.00	32519	4.34 x 3.53	34853	5.50 x 1.50	34866	6.35 x 1.63
34815	2.00 x 1.00	34826	3.30 x 1.00	33151	4.34 x 3.53	30044	5.50 x 1.70	30509	6.35 x 3.17
32827	2.00 x 1.75	34827	3.30 x 1.60	34838	4.37 x 1.59	30108	5.50 x 2.00	32165	6.35 x 3.17
34231	2.00 x 2.00	32640	3.30 x 2.40	32351	4.40 x 1.20	30109	5.50 x 2.00	30091	6.40 x 1.90
34816	2.06 x 2.62	30013	3.40 x 1.50	30071	4.40 x 1.80	30325	5.50 x 2.80	34444	6.45 x 1.25
34817	2.06 x 2.62	33414	3.40 x 2.60	31603	4.40 x 2.62	32137	5.50 x 3.00	32242	6.50 x 1.00
34816	2.06 x 2.62	34043	3.50 x 1.20	31603	4.42 x 2.62	30608	5.50 x 3.50	36869	6.50 x 1.50
32823	2.20 x 1.20	32349	3.50 x 1.25	31603	4.42 x 2.62	33531	5.60 x 1.70	36869	6.50 x 1.50
34818	2.20 x 1.60	30103	3.50 x 2.00	33485	4.44 x 1.07	30174	5.60 x 2.20	30074	6.50 x 1.80
34245	2.20 x 1.75	30103	3.50 x 2.00	31558	4.47 x 1.78	34854	5.60 x 2.40	30113	6.50 x 2.00
34819	2.38 x 0.79	32630	3.50 x 2.40	31558	4.47 x 1.78	34855	5.60 x 2.40	30112	6.50 x 2.00
34820	2.38 x 1.19	30037	3.60 x 1.60	34839	4.47 x 1.78	32820	5.70 x 1.00	30113	6.50 x 2.00
34510	2.40 x 1.90	33245	3.60 x 1.60	34840	4.50 x 1.00	34856	5.70 x 1.20	31924	6.50 x 2.30
33578	2.50 x 1.00	33409	3.63 x 2.62	32229	4.50 x 1.50	30665	5.70 x 1.50	.....	6.50 x 2.50
32060	2.50 x 1.25	34829	3.63 x 2.62	32229	4.50 x 1.50	30665	5.70 x 1.50	36421	6.50 x 3.40
36500	2.50 x 1.50	34829	3.63 x 2.62	32229	4.50 x 1.50	30045	5.70 x 1.70	36433	6.50 x 3.50
30100	2.50 x 2.00	31557	3.68 x 1.78	34677	4.50 x 1.80	30090	5.70 x 1.90	30055	6.64 x 1.78
30100	2.50 x 2.00	31557	3.68 x 1.78	34841	4.50 x 1.90	30090	5.70 x 1.90	30061	6.75 x 1.78
31555	2.57 x 1.78	31557	3.68 x 1.78	31535	4.50 x 2.00	33148	5.70 x 2.50	30061	6.75 x 1.78
31555	2.57 x 1.78	34172	3.70 x 0.50	34842	4.50 x 2.40	32825	5.80 x 1.20	34868	6.80 x 1.90
34821	2.60 x 1.30	30028	3.70 x 1.59	30208	4.50 x 2.50	30072	5.80 x 1.80	34869	6.80 x 2.60
32517	2.60 x 1.50	33508	3.70 x 1.59	30208	4.50 x 2.50	33887	5.80 x 1.90	30069	6.85 x 1.80
33211	2.60 x 1.50	32612	3.70 x 1.80	32515	4.50 x 3.50	34143	5.94 x 3.53	34667	6.85 x 1.80
30070	2.60 x 1.80	32612	3.70 x 1.80	32639	4.50 x 5.00	34858	5.94 x 3.53	34870	6.90 x 1.46
32186	2.60 x 1.80	34831	3.70 x 1.90	31935	4.60 x 1.75	32059	6.00 x 1.00	36359	7.00 x 0.50
34822	2.70 x 1.95	33178	3.70 x 2.00	31935	4.60 x 1.75	32059	6.00 x 1.00	34447	7.00 x 1.00
34108	2.77 x 1.98	32322	3.80 x 1.30	30054	4.60 x 1.75	33522	6.00 x 1.50	34495	7.00 x 1.20
34108	2.77 x 1.98	33344	3.80 x 1.60	34843	4.70 x 1.42	33522	6.00 x 1.50	34495	7.00 x 1.20
34145	2.80 x 1.27	33134	3.80 x 1.90	34844	4.70 x 1.42	30073	6.00 x 1.80	30012	7.00 x 1.40
31602	2.84 x 2.62	34832	3.80 x 3.50	34675	4.70 x 2.90	30073	6.00 x 1.80	30018	7.00 x 1.50
31558	4.77 x 1.78	32999	6.00 x 1.80	32619	7.00 x 1.50	32619	7.00 x 1.50	32619	7.00 x 1.50
33303	4.80 x 1.90	30110	6.00 x 2.00	34693	7.00 x 1.50	34693	7.00 x 1.50	34693	7.00 x 1.50
34845	4.80 x 2.20	33240	6.00 x 2.00	30046	7.00 x 1.70	30046	7.00 x 1.70	30046	7.00 x 1.70
36907	5.00 x 1.00	30110	6.00 x 2.00	30046	7.00 x 1.78	30046	7.00 x 1.78	30046	7.00 x 1.78
30016	5.00 x 1.50	36323	6.00 x 2.00	30114	7.00 x 2.00	30114	7.00 x 2.00	30114	7.00 x 2.00
30016	5.00 x 1.50	36941	6.00 x 2.20	30114	7.00 x 2.00	30114	7.00 x 2.00	30114	7.00 x 2.00
34846	5.00 x 1.50	34858	6.00 x 2.30	30114	7.00 x 2.00	30114	7.00 x 2.00	30114	7.00 x 2.00
34082	5.00 x 1.70	34859	6.00 x 2.30	34871	7.00 x 2.50	34871	7.00 x 2.50	34871	7.00 x 2.50
34082	5.00 x 1.70	30210	6.00 x 2.50	34871	7.00 x 2.50	34871	7.00 x 2.50	34871	7.00 x 2.50
30107	5.00 x 2.00	30210	6.00 x 2.50	31539	7.00 x 2.60	31539	7.00 x 2.60	31539	7.00 x 2.60
32620	5.00 x 2.00	33002	6.00 x 2.60	30870	7.00 x 2.60	30870	7.00 x 2.60	30870	7.00 x 2.60
33374	5.00 x 2.00	32230	6.00 x 3.00	33630	7.00 x 2.60	33630	7.00 x 2.60	33630	7.00 x 2.60



# Anéis



INCOVE VEDAÇÕES LTDA.

Cód.	Di x Esp.	Cód.	Di x Esp.	Cód.	Di x Esp.	Cód.	Di x Esp.	Cód.	Di x Esp.
30342	7.00 x 3.00	30062	7.65 x 1.78	30213	8.50 x 2.50	34903	9.40 x 0.70	33823	10.00 x 4.90
33635	7.00 x 3.00	34448	7.65 x 5.00	31925	8.50 x 3.00	34904	9.50 x 1.00	34920	10.00 x 5.00
36364	7.00 x 3.50	34882	7.70 x 1.20	30610	8.50 x 3.50	33764	9.50 x 1.40	32476	10.00 x 5.50
30844	7.00 x 4.00	32475	7.70 x 2.00	34619	8.50 x 3.50	30039	9.50 x 1.60	32476	10.00 x 5.50
31045	7.00 x 5.00	33440	7.70 x 2.40	34891	8.50 x 4.00	33244	9.50 x 1.60	34040	10.00 x 6.00
32423	7.00 x 5.00	30017	7.80 x 1.90	34892	8.50 x 4.60	32240	9.50 x 1.80	33521	10.00 x 6.50
33106	7.00 x 6.00	30094	7.80 x 1.90	32516	8.60 x 2.40	30120	9.50 x 2.00	34921	10.00 x 6.50
30038	7.10 x 1.60	34809	7.80 x 2.20	30520	8.60 x 3.20	30009	9.50 x 2.00	30201	10.30 x 2.40
33749	7.10 x 1.80	34106	7.80 x 3.75	34486	8.70 x 2.00	34905	9.50 x 2.40	34922	10.32 x 1.98
31462	7.14 x 7.54	33594	7.90 x 1.40	34893	8.70 x 4.00	30216	9.50 x 2.50	34923	10.46 x 5.33
33304	7.20 x 1.00	33881	7.90 x 1.60	32088	8.73 x 1.78	32629	9.50 x 2.50	34924	10.46 x 5.33
34872	7.20 x 1.80	30075	7.90 x 1.80	32088	8.73 x 1.78	30217	9.50 x 2.50	34925	10.50 x 1.00
30092	7.20 x 1.90	32281	7.93 x 1.80	34894	8.73 x 1.83	30348	9.50 x 3.00	33888	10.50 x 1.50
34723	7.20 x 1.90	30193	7.94 x 2.38	34895	8.90 x 1.30	30238	9.50 x 3.20	34926	10.50 x 1.50
34723	7.20 x 1.90	34883	7.94 x 4.76	30077	8.90 x 1.80	30612	9.50 x 3.50	33888	10.50 x 1.50
34723	7.20 x 1.90	31046	7.94 x 5.00	32280	8.90 x 1.90	34906	9.50 x 4.00	3447	10.50 x 2.00
34873	7.20 x 2.50	30004	8.00 x 1.00	30311	8.90 x 2.70	33781	9.52 x 1.58	33447	10.50 x 2.00
34874	7.30 x 1.20	30004	8.00 x 1.00	32812	8.92 x 1.83	30194	9.52 x 2.38	32414	10.50 x 2.50
30983	7.30 x 2.40	30019	8.00 x 1.50	30005	9.00 x 1.00	30510	9.52 x 3.17	30219	10.50 x 2.50
30983	7.30 x 2.40	30019	8.00 x 1.50	30020	9.00 x 1.50	30773	9.52 x 3.57	32414	10.50 x 2.50
30983	7.30 x 2.40	33836	8.00 x 1.78	34500	9.00 x 1.50	34907	9.53 x 2.78	34224	10.50 x 2.80
36495	7.30 x 3.60	33836	8.00 x 1.80	30048	9.00 x 1.70	34908	9.53 x 6.35	34224	10.50 x 2.80
32149	7.40 x 0.80	30118	8.00 x 2.00	32889	9.00 x 1.70	34909	9.53 x 7.94	30350	10.50 x 3.00
30093	7.40 x 1.90	33513	8.00 x 2.00	30048	9.00 x 1.70	32279	9.60 x 2.00	32192	10.50 x 4.00
34105	7.50 x 1.20	30175	8.00 x 2.20	30089	9.00 x 1.85	32279	9.60 x 2.00	32476	10.50 x 5.40
34875	7.50 x 1.30	30211	8.00 x 2.50	31935	9.00 x 1.85	34910	9.60 x 2.70	33839	10.50 x 6.25
34876	7.50 x 1.30	32762	8.00 x 2.50	30089	9.00 x 1.85	30522	9.60 x 3.20	32815	10.52 x 1.83
33664	7.50 x 1.50	30211	8.00 x 2.50	30119	9.00 x 2.00	34911	9.66 x 1.78	30524	10.60 x 3.20
33664	7.50 x 1.50	30344	8.00 x 3.00	33906	9.00 x 2.00	36843	9.70 x 1.90	34927	10.69 x 3.53
33559	7.50 x 1.75	32962	8.00 x 3.00	32592	9.00 x 2.00	36843	9.70 x 1.90	34928	10.69 x 3.53
30116	7.50 x 2.00	32169	8.00 x 3.00	32592	9.00 x 2.00	34116	9.70 x 3.70	33535	10.70 x 1.50
30116	7.50 x 2.00	30846	8.00 x 4.00	30214	9.00 x 2.50	34083	9.80 x 1.20	31606	10.77 x 0.00
32113	7.50 x 2.50	30846	8.00 x 4.00	30214	9.00 x 2.50	34912	9.80 x 1.30	31606	10.77 x 2.62
30343	7.50 x 3.00	30846	8.00 x 4.00	36875	9.00 x 2.80	36843	9.80 x 1.80	31606	10.77 x 2.62
32366	7.50 x 3.20	30978	8.00 x 4.50	30675	9.00 x 2.80	34369	9.80 x 2.40	34929	10.78 x 1.26
30609	7.50 x 3.50	34885	8.00 x 5.00	30347	9.00 x 3.00	32837	9.80 x 2.40	33928	10.80 x 1.30
30845	7.50 x 4.00	33727	8.10 x 1.60	33812	9.00 x 3.00	34913	9.90 x 2.60	34367	10.80 x 1.78
34877	7.50 x 6.50	30015	8.10 x 1.80	30521	9.00 x 3.20	34327	9.90 x 3.00	34367	10.80 x 1.78
34878	7.52 x 3.53	30076	8.10 x 1.80	30611	9.00 x 3.50	32487	10.00 x 1.00	34810	10.80 x 1.80
34879	7.52 x 3.53	30181	8.30 x 2.30	30847	9.00 x 4.00	32497	10.00 x 1.00	31563	10.82 x 1.78
34878	7.52 x 3.53	33606	8.30 x 2.40	34896	9.00 x 4.50	34321	10.00 x 1.30	31563	10.82 x 1.78
34880	7.54 x 3.97	33606	8.30 x 2.40	34309	9.00 x 5.00	34915	10.00 x 1.30	31563	10.82 x 1.78
34150	7.59 x 2.62	34886	8.30 x 2.80	34273	9.00 x 5.00	30021	10.00 x 1.50	30596	10.90 x 3.30
33393	7.59 x 2.62	34887	8.30 x 2.90	33613	9.12 x 1.58	33267	10.00 x 1.50	36363	11.00 x 1.00
34150	7.59 x 2.62	34888	8.33 x 3.18	34897	9.12 x 3.53	33267	10.00 x 1.50	34930	11.00 x 1.40
33393	7.59 x 2.62	34889	8.33 x 3.57	34898	9.12 x 3.53	_____	10.00 x 1.75	33292	11.00 x 1.50
32819	7.60 x 0.80	32862	8.40 x 4.70	34899	9.13 x 1.59	32504	10.00 x 1.80	33292	11.00 x 1.50
32809	7.65 x 1.63	30001	8.43 x 0.78	34900	9.13 x 2.38	32504	10.00 x 1.80	30122	11.00 x 2.00
30038	7.65 x 1.63	36933	8.50 x 1.00	34901	9.13 x 2.78	30121	10.00 x 2.00	34666	11.00 x 2.00
31561	7.65 x 1.78	34890	8.50 x 1.50	34902	9.13 x 6.99	32227	10.00 x 2.00	34658	11.00 x 2.00
31561	7.65 x 1.78	30047	8.50 x 1.70	34088	9.19 x 2.62	30121	10.00 x 2.00	34658	11.00 x 2.00
34724	7.65 x 1.78	30047	8.50 x 1.70	31605	9.19 x 2.62	34916	10.00 x 2.20	36380	11.00 x 2.20
30062	7.65 x 1.78	33586	8.50 x 1.80	34664	9.19 x 2.62	34917	10.00 x 2.20	31954	11.00 x 2.40
31561	7.65 x 1.78	34206	8.50 x 2.00	34572	9.19 x 2.62	30902	10.00 x 2.25	34931	11.00 x 2.50
30062	7.65 x 1.78	34206	8.50 x 2.00	34664	9.19 x 2.62	36403	10.00 x 2.40	30290	11.00 x 2.50
31605	9.19 x 2.62	31562	9.25 x 1.78	30523	10.00 x 3.20	30218	10.00 x 2.50	34931	11.00 x 2.50
30078	9.20 x 1.80	31562	9.25 x 1.78	30613	10.00 x 3.50	32459	10.00 x 2.50	30290	11.00 x 2.60
33224	9.20 x 2.50	30063	9.25 x 1.78	30613	10.00 x 3.50	_____	10.00 x 2.50	33736	11.00 x 2.60
32841	9.20 x 2.80	31562	9.25 x 1.78	30831	10.00 x 3.90	30349	10.00 x 3.00	30290	11.00 x 2.60
31355	9.20 x 6.35	33478	9.30 x 2.40	34918	10.00 x 4.00	32954	10.00 x 3.00	30321	11.00 x 2.75
31562	9.25 x 1.78	32949	9.30 x 2.40	34919	10.00 x 4.30	30523	10.00 x 3.20	31878	11.00 x 2.75
31562	9.25 x 1.78	30326	9.30 x 2.80	34320	10.00 x 4.50	30613	10.00 x 3.50	30321	11.00 x 2.75
30063	9.25 x 1.78					30613	10.00 x 3.50	30351	11.00 x 3.00
31562	9.25 x 1.78					30831	10.00 x 3.90	30351	11.00 x 3.00
33478	9.30 x 2.40					34918	10.00 x 4.00	30351	11.00 x 3.00
32949	9.30 x 2.40							30351	11.00 x 3.00
30326	9.30 x 2.80							30351	11.00 x 3.00



Cód.	Di	x	Esp.	Cód.	Di	x	Esp.	Cód.	Di	x	Esp.	Cód.	Di	x	Esp.	Cód.	Di	x	Esp.
30525	11.00	x	3.20	30304	11.90	x	2.62	31607	12.37	x	2.62	34310	13.00	x	5.50	33450	14.00	x	2.77
34933	11.00	x	3.40	34623	11.90	x	2.62	34958	12.37	x	2.62	34963	13.10	x	1.98	33450	14.00	x	2.77
30872	11.00	x	3.50	34949	11.90	x	3.00	31607	12.37	x	2.62		13.10	x	2.00	34976	14.00	x	2.80
34747	11.00	x	3.50	32212	11.90	x	3.96	32257	12.40	x	1.80	34964	13.10	x	4.76	31941	14.00	x	2.90
34934	11.00	x	4.00	30098	11.91	x	1.98	30225	12.40	x	2.50	34042	13.20	x	1.50	30360	14.00	x	3.00
34935	11.00	x	4.50	36379	12.00	x	0.80	30225	12.40	x	2.50	32346	13.30	x	2.40	30360	14.00	x	3.00
34498	11.00	x	7.00		12.00	x	1.20	31607	12.40	x	2.62	32346	13.30	x	2.40	34661	14.00	x	3.00
32829	11.10	x	1.80	30023	12.00	x	1.50	32317	12.40	x	2.62	34965	13.30	x	2.50	30360	14.00	x	3.00
32306	11.10	x	2.40	30023	12.00	x	1.50	31514	12.40	x	2.70	30329	13.40	x	2.80	31190	14.00	x	3.20
30220	11.10	x	2.50	34484	12.00	x	1.60	32575	12.40	x	3.10	33728	13.40	x	2.90	31190	14.00	x	3.20
30313	11.10	x	2.70	34484	12.00	x	1.60	31564	12.42	x	1.78	34104	13.40	x	5.00	31190	14.00	x	3.20
34936	11.11	x	1.78	36309	12.00	x	1.80	31564	12.42	x	1.78	32811	13.46	x	2.08	30621	14.00	x	3.50
30195	11.11	x	2.38	30126	12.00	x	2.00	31564	12.42	x	1.78	34966	13.49	x	2.38	33777	14.00	x	4.50
33700	11.20	x	1.70	30126	12.00	x	2.00	34695	12.42	x	1.78	34967	13.49	x	2.78	32164	14.00	x	5.00
30079	11.20	x	1.80	30126	12.00	x	2.00	36335	12.42	x	1.78	34129	13.49	x	4.76	34977	14.00	x	6.75
34937	11.20	x	2.20	34101	12.00	x	2.25	34959	12.50	x	1.00	33795	13.49	x	6.35	34179	14.00	x	7.00
34938	11.20	x	3.70	34101	12.00	x	2.25	36501	12.50	x	1.50	34968	13.50	x	1.00	30817	14.20	x	3.80
34939	11.30	x	2.00	30223	12.00	x	2.50	34791	12.50	x	1.80	34333	13.50	x	1.75	30512	14.29	x	3.17
30203	11.30	x	2.40	34788	12.00	x	2.50	34791	12.50	x	1.80	30131	13.50	x	2.00	33782	14.29	x	3.97
30203	11.30	x	2.40	30022	12.00	x	2.60	30127	12.50	x	2.00	30128	13.50	x	2.25	34978	14.29	x	4.76
32660	11.30	x	2.40	30291	12.00	x	2.60	30127	12.50	x	2.00	30229	13.50	x	2.50	34979	14.29	x	7.94
30202	11.30	x	2.40	31890	12.00	x	2.70	30226	12.50	x	2.50	33924	13.50	x	2.50	30205	14.30	x	2.40
36415	11.30	x	2.60	31890	12.00	x	2.70	33411	12.50	x	2.50	33058	13.50	x	2.50	30205	14.30	x	2.40
30352	11.30	x	3.00	30354	12.00	x	3.00	30355	12.50	x	3.00	30358	13.50	x	3.00	34980	14.30	x	3.90
34067	11.50	x	1.00	30354	12.00	x	3.00	30616	12.50	x	3.50	32162	13.50	x	3.20	34981	14.40	x	1.00
34940	11.50	x	1.50	30527	12.00	x	3.20	30529	12.60	x	3.20	30620	13.50	x	3.50	33694	14.40	x	3.20
30080	11.50	x	1.80	32214	12.00	x	3.50	30029	12.70	x	1.59	33713	13.50	x	3.50	30777	14.40	x	3.60
34559	11.50	x	2.00	31938	12.00	x	4.00	33855	12.70	x	1.59	30816	13.50	x	3.80	30818	14.40	x	3.80
30124	11.50	x	2.00	31938	12.00	x	4.00	30040	12.70	x	1.60	33878	13.50	x	4.00	34982	14.50	x	1.50
33844	11.50	x	2.00	31020	12.00	x	4.50	30040	12.70	x	1.60	34443	13.60	x	2.78	30232	14.50	x	2.50
30221	11.50	x	2.50	36321	12.00	x	5.00	33899	12.70	x	1.78	34443	13.60	x	2.78	33602	14.50	x	2.50
30221	11.50	x	2.50	34173	12.00	x	6.00	33562	12.70	x	2.00	34443	13.60	x	2.78	34781	14.50	x	2.50
34941	11.50	x	2.70	32975	12.00	x	7.00	33568	12.70	x	2.00	34969	13.60	x	3.00	30323	14.50	x	2.75
34942	11.50	x	2.70	32412	12.00	x	7.00	34512	12.70	x	2.30	34969	13.60	x	3.00	30330	14.50	x	2.80
30327	11.50	x	2.80	34950	12.00	x	7.50	30304	12.70	x	2.70	34969	13.60	x	3.00	30361	14.50	x	3.00
30339	11.50	x	2.90	34113	12.07	x	5.30	30356	12.70	x	3.00	30531	13.60	x	3.20	30361	14.50	x	3.00
30353	11.50	x	3.00	34952	12.07	x	5.33	33401	12.70	x	3.00	31167	13.64	x	5.33	30622	14.50	x	3.60
32465	11.50	x	3.20	30670	12.10	x	2.70	30511	12.70	x	3.17	34970	13.64	x	5.33	33690	14.50	x	3.60
30614	11.50	x	3.50	32680	12.17	x	2.62	30511	12.70	x	3.17	34971	13.70	x	1.00	34983	14.50	x	5.30
30614	11.50	x	3.50	31939	12.20	x	2.75	31940	12.70	x	3.50	32273	13.70	x	2.00	30582	14.60	x	3.20
34286	11.50	x	3.70	30322	12.20	x	2.75	31021	12.70	x	4.76	34515	13.80	x	2.50	34984	14.68	x	3.57
30850	11.50	x	4.00	33198	12.20	x	3.90	34960	12.70	x	6.35	34515	13.80	x	2.50	34985	14.68	x	6.35
34943	11.50	x	6.50	31047	12.20	x	5.00	30618	12.80	x	3.50	34515	13.80	x	2.50	34986	14.80	x	2.60
34944	11.51	x	5.95	33984	12.25	x	4.35	32932	13.00	x	1.00	34973	13.80	x	8.00	34987	14.80	x	2.60
36947	11.60	x	2.20	33681	12.29	x	3.53	32932	13.00	x	1.00	34098	13.87	x	3.53	30183	14.90	x	2.30
30204	11.60	x	2.40	34954	12.29	x	3.53	34961	13.00	x	1.20	34974	13.87	x	3.53	30186	14.90	x	2.38
30526	11.60	x	3.20	36345	12.29	x	3.53	30024	13.00	x	1.50	31608	13.94	x	2.62	32699	15.00	x	1.00
30832	11.60	x	3.90	33790	12.30	x	1.00	30024	13.00	x	1.50	34975	13.94	x	2.62	34987	15.00	x	1.00
34945	11.62	x	1.78	34437	12.30	x	2.00	34232	13.00	x	1.80	31608	13.94	x	2.62	32882	15.00	x	1.50
34234	11.70	x	1.60	34437	12.30	x	2.00	32554	13.00	x	2.00	30006	14.00	x	1.00	32882	15.00	x	1.50
36499	11.70	x	1.70	34955	12.30	x	2.38	32554	13.00	x	2.00	33327	14.00	x	1.10	30082	15.00	x	1.70
34946	11.70	x	4.00	34956	12.30	x	2.40	32554	13.00	x	2.00	31901	14.00	x	1.50	30049	15.00	x	1.70
34947	11.87	x	0.96	30320	12.30	x	2.80	34148	13.00	x	2.30	31901	14.00	x	1.50	30082	15.00	x	1.80
34948	11.89	x	1.98	36377	12.30	x	3.20	30228	13.00	x	2.50	31565	14.00	x	1.78	30133	15.00	x	2.00
30346	11.90	x	1.98	31048	12.30	x	5.00	33679	13.00	x	2.50	30064	14.00	x	1.78	30133	15.00	x	2.00
								30928	13.00	x	2.60	31565	14.00	x	1.78	36292	15.00	x	2.30
								30928	13.00	x	2.60	30081	14.00	x	1.80	31942	15.00	x	2.50
								30928	13.00	x	2.60	34721	14.00	x	1.80	34622	15.00	x	2.50
								30357	13.00	x	3.00	30132	14.00	x	2.00	30292	15.00	x	2.60
								30357	13.00	x	3.00	30132	14.00	x	2.00	30292	15.00	x	2.60
								30530	13.00	x	3.20	30132	14.00	x	2.00	36418	15.00	x	2.80
								34962	13.00	x	3.40	30176	14.00	x	2.20	36418	15.00	x	2.80
								30619	13.00	x	3.50	30182	14.00	x	2.30	34574	15.00	x	3.00
								30619	13.00	x	3.50	34617	14.00	x	2.50	30362	15.00	x	3.00
								30815	13.00	x	3.80	30231	14.00	x	2.50	32961	15.00	x	3.00
								30851	13.00	x	4.00	33677	14.00	x	2.50	33750	15.00	x	3.00
								30851	13.00	x	4.00	33080	14.00	x	2.50	32353	15.00	x	3.10



# Anéis



INCOVE VEDAÇÕES LTDA.

Cód.	Di x Esp.	Cód.	Di x Esp.	Cód.	Di x Esp.	Cód.	Di x Esp.	Cód.	Di x Esp.
32353	15.00 x 3.10	30065	15.60 x 1.78	30366	16.30 x 3.00	33304	17.30 x 2.20	30084	18.50 x 1.80
32353	15.00 x 3.10	30065	15.60 x 1.78	30177	16.35 x 2.20	31094	17.30 x 2.40	32617	18.50 x 2.00
32353	15.00 x 3.10	31566	15.60 x 1.78	32064	16.50 x 1.75	31094	17.30 x 2.40	32617	18.50 x 2.00
30533	15.00 x 3.20	30534	15.60 x 3.20	30185	16.50 x 2.30	33561	17.30 x 3.00	30243	18.50 x 2.50
33715	15.00 x 3.30	33232	15.60 x 3.20	30239	16.50 x 2.50	33561	17.30 x 3.00	33490	18.50 x 2.50
30623	15.00 x 3.50	30625	15.60 x 3.50	34795	16.50 x 2.50	30801	17.30 x 3.70	33820	18.50 x 2.50
33452	15.00 x 4.00	33997	15.70 x 10.00	33224	16.50 x 2.50	30206	17.40 x 2.40	32416	18.50 x 2.50
30979	15.00 x 4.50	33212	15.75 x 2.75	35009	16.50 x 2.62	33701	17.40 x 2.60	30370	18.50 x 3.00
31049	15.00 x 5.00	33212	15.75 x 2.75	35010	16.50 x 2.62	33192	17.40 x 3.60	32477	18.50 x 3.00
31212	15.00 x 5.50	30043	15.80 x 1.65	35011	16.50 x 2.80	35021	17.40 x 6.00	30540	18.50 x 3.20
33815	15.00 x 5.50	30043	15.80 x 1.65	33441	16.50 x 3.00	35022	17.46 x 2.78	30633	18.50 x 3.50
34800	15.00 x 7.90	34996	15.80 x 6.30	33441	16.50 x 3.00	30836	17.46 x 3.97	32116	18.50 x 3.50
30099	15.08 x 1.98	30513	15.87 x 3.17	33441	16.50 x 3.00	32150	17.50 x 1.00	35032	18.50 x 4.00
34988	15.08 x 2.38	31022	15.87 x 4.76	30627	16.50 x 3.50	30241	17.50 x 2.50	34492	18.50 x 5.00
30305	15.08 x 2.62	31023	15.87 x 4.76	30799	16.50 x 3.70	30294	17.50 x 2.60	31674	18.64 x 3.53
34989	15.08 x 2.78	34997	15.88 x 2.38	31496	16.50 x 8.80	33228	17.50 x 2.60	35033	18.64 x 3.53
34990	15.08 x 7.94	34999	15.88 x 3.97	30137	16.60 x 2.00	30368	17.50 x 3.00	31674	18.64 x 3.53
30315	15.10 x 2.70	35001	15.88 x 7.14	32558	16.60 x 2.00	32463	17.50 x 3.20	30096	18.70 x 1.90
32831	15.20 x 1.80	30235	15.90 x 2.50	30535	16.60 x 3.20	30630	17.50 x 3.50	30803	18.70 x 3.70
34991	15.20 x 1.98	32134	16.00 x 1.00	35012	16.67 x 4.76	30802	17.50 x 3.70	30803	18.70 x 3.70
32057	15.20 x 3.80	32270	16.00 x 1.25	34264	16.70 x 4.00	35023	17.50 x 4.00	31611	18.72 x 2.62
32146	15.24 x 3.17	33152	16.00 x 1.50	34796	16.80 x 2.50	30186	17.60 x 2.50	35034	18.72 x 2.62
32247	15.24 x 5.33	33152	16.00 x 1.50	35013	16.81 x 5.33	30537	17.60 x 3.20	31611	18.72 x 2.62
32326	15.24 x 5.33	30051	16.00 x 1.70	35014	16.81 x 5.33	32070	17.70 x 1.40	31568	18.77 x 1.78
34992	15.24 x 5.33	33590	16.00 x 1.80	32042	16.90 x 2.70	33167	17.80 x 2.40	31945	18.77 x 1.78
30050	15.30 x 1.70	30136	16.00 x 2.00	35015	17.00 x 1.00	30295	17.80 x 2.60	31568	18.77 x 1.78
34086	15.30 x 2.40	30136	16.00 x 2.00	35016	17.00 x 1.00	31914	17.80 x 3.17	33582	19.00 x 1.50
34428	15.30 x 2.40	30184	16.00 x 2.30	30212	17.00 x 1.20	35027	17.86 x 6.35	33582	19.00 x 1.50
34086	15.30 x 2.40	30184	16.00 x 2.30	35017	17.00 x 1.50	32816	17.93 x 2.46	32828	19.00 x 1.75
33753	15.30 x 4.30	30236	16.00 x 2.50	35018	17.00 x 1.50	33445	18.00 x 1.50	31946	19.00 x 2.00
31050	15.40 x 5.00	30237	16.00 x 2.50	30041	17.00 x 1.60	33445	18.00 x 1.50	30141	19.00 x 2.00
34804	15.47 x 3.53	32958	16.00 x 2.50	30095	17.00 x 1.80	36931	18.00 x 1.78	30142	19.00 x 2.00
34993	15.47 x 3.53	34787	16.00 x 2.70	31944	17.00 x 1.90	30140	18.00 x 2.00	35035	19.00 x 2.30
34993	15.47 x 3.53	30365	16.00 x 3.00	30139	17.00 x 2.00	33810	18.00 x 2.00	35036	19.00 x 2.30
34994	15.48 x 3.18	30365	16.00 x 3.00	34655	17.00 x 2.00	30187	18.00 x 2.30	32341	19.00 x 2.40
33138	15.50 x 1.50	32511	16.00 x 3.20	30139	17.00 x 2.00	30242	18.00 x 2.50	32325	19.00 x 2.50
30135	15.50 x 2.00	30626	16.00 x 3.50	36298	17.00 x 2.30	30242	18.00 x 2.50	30244	19.00 x 2.50
30134	15.50 x 2.00	30798	16.00 x 3.70	30293	17.00 x 2.40	34643	18.00 x 2.70	30244	19.00 x 2.50
32321	15.50 x 2.20	30819	16.00 x 3.80	30240	17.00 x 2.50	34643	18.00 x 2.70	33563	19.00 x 2.60
30234	15.50 x 2.50	30852	16.00 x 4.00	30240	17.00 x 2.50	34643	18.00 x 2.70	30296	19.00 x 2.60
32627	15.50 x 2.50	34694	16.00 x 4.00	30367	17.00 x 3.00	30369	18.00 x 3.00	33563	19.00 x 2.62
33060	15.50 x 2.50	32900	16.00 x 4.50	33399	17.00 x 3.00	30369	18.00 x 3.00	30316	19.00 x 2.70
30363	15.50 x 3.00	32900	16.00 x 4.50	30367	17.00 x 3.00	30531	18.00 x 3.20	35037	19.00 x 2.78
30624	15.50 x 3.50	32521	16.00 x 5.00	30536	17.00 x 3.20	30632	18.00 x 3.50	30372	19.00 x 3.00
33133	15.50 x 4.20	34710	16.00 x 5.00	30536	17.00 x 3.20	30632	18.00 x 3.50	33013	19.00 x 3.00
34995	15.50 x 4.50	31454	16.00 x 7.50	30628	17.00 x 3.50	33994	18.00 x 3.80	34631	19.00 x 3.00
31922	15.50 x 5.00	35002	16.00 x 8.00	30628	17.00 x 3.50	30854	18.00 x 4.00	33074	19.00 x 3.17
31943	15.50 x 6.00	35003	16.00 x 10.00	30853	17.00 x 4.00	35029	18.00 x 4.50	30661	19.00 x 3.20
31287	15.50 x 6.00	35004	16.20 x 1.00	30853	17.00 x 4.00	31011	18.00 x 4.70	30634	19.00 x 3.50
31609	15.54 x 2.62	35005	16.20 x 2.50	30853	17.00 x 4.00	31011	18.00 x 4.70	30634	19.00 x 3.50
31609	15.54 x 2.62	35006	16.20 x 4.20	34644	17.00 x 4.00	30379	18.00 x 5.00	30855	19.00 x 4.00
30307	15.54 x 2.62	35007	16.20 x 4.90	31061	17.00 x 5.00	32200	18.00 x 5.00	35078	19.00 x 4.50
30306	15.54 x 2.62	31909	16.26 x 2.50	31061	17.00 x 5.00	32796	18.00 x 5.00	35079	19.00 x 4.70
36338	15.54 x 2.62	35008	16.27 x 2.38	30138	17.00 x 12.00	35030	18.00 x 5.30	31059	19.00 x 5.00
31566	15.60 x 1.78	32615	16.30 x 1.80	35019	17.04 x 3.53	32958	18.00 x 5.50	31933	19.00 x 5.00
				35019	17.04 x 3.53	32076	18.00 x 6.00	34080	19.00 x 5.30
				31610	17.12 x 2.62	32076	18.00 x 6.00	32140	19.00 x 5.50
				31610	17.12 x 2.62	33471	18.00 x 6.50	35080	19.00 x 8.00
				34607	17.12 x 2.62	31413	18.00 x 7.00	30030	19.05 x 1.59
				30257	17.12 x 2.62	30778	18.20 x 3.60	35081	19.05 x 2.80
				31610	17.12 x 2.62	30556	18.20 x 4.80	35082	19.05 x 3.18
				31567	17.17 x 1.78	33745	18.30 x 2.40	35083	19.05 x 3.18
				34728	17.17 x 1.78	34069	18.40 x 2.80	31356	19.05 x 6.35
				32257	17.17 x 1.78	34600	18.40 x 2.80	32842	19.10 x 2.90
				31567	17.17 x 1.78	35024	18.40 x 5.33	32807	19.18 x 2.46
				31567	17.17 x 1.78	35031	18.42 x 5.33	35084	19.18 x 2.46
				36299	17.30 x 1.78	33345	18.50 x 1.00	34803	19.20 x 0.00







# Anéis



INCOVE VEDAÇÕES LTDA.

Cód.	Di x Esp.	Cód.	Di x Esp.	Cód.	Di x Esp.	Cód.	Di x Esp.	Cód.	Di x Esp.
33189	19.20 x 1.40	30636	20.00 x 5.50	32422	21.00 x 5.00	32466	22.00 x 7.50	35120	23.02 x 2.78
31947	19.20 x 2.50	35093	20.00 x 6.00	34663	21.00 x 5.00	32233	22.20 x 3.00	35121	23.16 x 5.33
30245	19.20 x 2.50	35094	20.00 x 6.50	33743	21.00 x 6.00	32888	22.20 x 3.00	35122	23.16 x 5.33
31094	19.20 x 3.00	35095	20.00 x 8.30	33107	21.00 x 6.00	34489	22.20 x 3.50	35121	23.16 x 5.33
32891	19.20 x 3.00	33328	20.00 x 10.00	35105	21.00 x 9.00	30804	22.20 x 3.70	31951	23.30 x 1.75
33083	19.30 x 2.40	34196	20.20 x 2.30		21.20 x 3.00	31910	22.20 x 4.36	30056	23.30 x 1.75
33083	19.30 x 2.40	33476	20.20 x 2.77	33672	21.30 x 3.10	31948	22.22 x 1.59	36434	23.30 x 2.20
32828	19.40 x 1.70	33476	20.20 x 2.77	33672	21.30 x 3.10	30033	22.22 x 1.59		23.30 x 2.40
34699	19.40 x 3.80	32802	20.20 x 3.60	35106	21.30 x 3.50	30033	22.22 x 1.59	32489	23.30 x 2.50
35085	19.45 x 3.18	32101	20.20 x 3.60	33007	21.30 x 3.60	30308	22.22 x 2.62	33265	23.30 x 2.90
35086	19.45 x 3.57	33114	20.20 x 5.50	34599	21.30 x 3.60	30837	22.22 x 3.97	33692	23.30 x 3.10
35087	19.50 x 1.00	31675	20.22 x 3.53	30980	21.30 x 4.50	31025	22.22 x 4.76	31677	23.39 x 3.53
34119	19.50 x 2.20	35097	20.22 x 3.53	35107	21.43 x 1.59	31465	22.22 x 7.94	35123	23.39 x 3.53
30246	19.50 x 2.50	31675	20.22 x 3.53	35108	21.43 x 3.18	35116	22.23 x 2.38	31677	23.39 x 3.53
30374	19.50 x 3.00	36893	20.29 x 2.62	30144	21.50 x 2.00	35117	22.23 x 3.53	30189	23.40 x 3.40
30373	19.50 x 3.00	36893	20.29 x 2.62	33058	21.50 x 2.00	34703	22.23 x 11.11	33726	23.40 x 5.70
30635	19.50 x 3.50	31612	20.29 x 2.62	35109	21.50 x 2.10	33607	22.30 x 1.35	31614	23.47 x 2.62
32203	19.60 x 2.00	31612	20.29 x 2.62	35110	21.50 x 2.30	30252	22.30 x 2.50	31614	23.47 x 2.62
30541	19.60 x 3.20	35098	20.30 x 1.00	30250	21.50 x 2.50	30252	22.30 x 2.50	31614	23.47 x 2.62
32845	19.70 x 3.00	32875	20.30 x 6.30	30250	21.50 x 2.50	36318	22.30 x 2.80	32520	23.47 x 2.95
35088	19.71 x 6.99	31569	20.34 x 1.78	30377	21.50 x 3.00	31180	22.30 x 3.50	32520	23.47 x 2.95
	19.80 x 1.60	34613	20.35 x 1.78	35111	21.50 x 5.00	31253	22.30 x 5.50	35125	23.50 x 1.00
35089	19.80 x 2.50	31569	20.35 x 1.78	32595	21.59 x 5.33	33588	22.40 x 4.00	35126	23.50 x 2.00
30295	19.80 x 2.60	34262	20.35 x 1.78	32553	21.59 x 5.33	35118	22.40 x 5.30	30254	23.50 x 2.50
30636	19.80 x 3.60	35099	20.50 x 2.00	35112	21.59 x 5.33	32821	22.50 x 1.30	30254	23.50 x 2.50
34348	19.80 x 3.60	30248	20.50 x 2.50	33581	21.60 x 1.70	30188	22.50 x 2.30	30388	23.50 x 3.00
32833	19.90 x 2.00	33210	20.50 x 2.50	33581	21.60 x 1.70	34350	22.50 x 2.50	32474	23.50 x 3.00
34253	19.90 x 5.30	30376	20.50 x 3.00	30544	21.60 x 3.20	30380	22.50 x 3.00	30548	23.50 x 3.20
34253	19.99 x 5.33	30376	20.50 x 3.00	34471	21.80 x 2.40	32121	22.50 x 3.00	30642	23.50 x 3.50
35091	19.99 x 5.33	30542	20.50 x 3.20	34471	21.80 x 2.40	30380	22.50 x 3.00	31952	23.50 x 3.50
33294	20.00 x 1.00	34153	20.60 x 1.59	30597	21.80 x 3.30	30641	22.50 x 3.50	34514	23.50 x 6.00
33294	20.00 x 1.00	33682	20.60 x 2.80	34705	21.80 x 3.30	34632	22.50 x 3.50	34514	23.50 x 6.00
36397	20.00 x 1.50	33762	20.60 x 7.30	36879	21.82 x 3.53	30641	22.50 x 3.50	33358	23.50 x 8.00
34621	20.00 x 2.00	35100	20.62 x 4.77	31676	21.82 x 3.53	30805	22.50 x 3.70	33109	23.50 x 8.50
30143	20.00 x 2.00	35101	20.63 x 2.38	31676	21.82 x 3.53	30858	22.50 x 4.00	31571	23.52 x 1.78
33092	20.00 x 2.00	35102	20.63 x 4.77	31613	21.89 x 2.62		22.60 x 2.40	35127	23.52 x 1.78
30143	20.00 x 2.00	35103	20.63 x 5.56	33472	21.89 x 2.62	30546	22.60 x 3.20	31571	23.52 x 1.78
33012	20.00 x 2.50	31055	20.64 x 5.00	31613	21.89 x 2.62	30146	22.80 x 2.00	35128	23.70 x 3.30
34614	20.00 x 2.50	35104	20.64 x 7.34	32836	21.90 x 2.00	32006	22.80 x 2.35	35129	23.70 x 7.60
33012	20.00 x 2.50	30507	20.80 x 3.20	32805	21.92 x 2.95	32147	23.00 x 1.10		23.80 x 2.40
30247	20.00 x 2.50	34807	21.00 x 1.50	35114	21.92 x 2.95	36921	23.00 x 1.50	35130	23.80 x 3.10
30317	20.00 x 2.70	36872	21.00 x 2.00	31570	21.95 x 1.78	32493	23.00 x 2.00	34794	23.80 x 3.50
30375	20.00 x 3.00	36872	21.00 x 2.00	35115	21.95 x 1.78	32493	23.00 x 2.00	34794	23.80 x 3.50
32944	20.00 x 3.00	34449	21.00 x 2.30	31570	21.95 x 1.78	36932	23.00 x 2.10	35131	23.90 x 2.00
33263	20.00 x 3.20	30249	21.00 x 2.50	33661	22.00 x 1.10	31949	23.00 x 2.50	30885	24.00 x 2.00
30636	20.00 x 3.50	30249	21.00 x 2.50	33009	22.00 x 1.50	31949	23.00 x 2.50	32460	24.00 x 2.00
30636	20.00 x 3.50	31544	21.00 x 2.80	33242	22.00 x 1.50	32509	23.00 x 2.70	33584	24.00 x 2.10
35092	20.00 x 3.70	31541	21.00 x 3.00	30145	22.00 x 2.00	30382	23.00 x 3.00	30255	24.00 x 2.50
30856	20.00 x 4.00	36461	21.00 x 3.00	33104	22.00 x 2.00	32488	23.00 x 3.00	32514	24.00 x 2.50
32198	20.00 x 4.00	30637	21.00 x 3.50	30251	22.00 x 2.50	30547	23.00 x 3.20	30255	24.00 x 2.50
34775	20.00 x 4.00	32250	21.00 x 4.00	33014	22.00 x 2.50	31192	23.00 x 3.50	30324	24.00 x 2.77
34575	20.00 x 4.50	32794	21.00 x 4.00	30378	22.00 x 3.00	33298	23.00 x 3.50	30324	24.00 x 2.77
34575	20.00 x 4.50	30980	21.00 x 4.50	30378	22.00 x 3.00	31921	23.00 x 3.50	36448	24.00 x 2.80
31054	20.00 x 5.00	31916	21.00 x 4.90	30545	22.00 x 3.20	35118	23.00 x 3.60	30384	24.00 x 3.00
32527	20.00 x 5.00	32074	21.00 x 5.00	32760	22.00 x 3.20	30820	23.00 x 3.80	31953	24.00 x 3.00
				30638	22.00 x 3.50	31950	23.00 x 4.00	34729	24.00 x 3.00
				32482	22.00 x 3.50	34497	23.00 x 4.50	30549	24.00 x 3.20
				30639	22.00 x 3.50	32236	23.00 x 5.00	33716	24.00 x 3.30
				30857	22.00 x 4.00	31057	23.00 x 5.00	35133	24.00 x 3.50
				30857	22.00 x 4.00	32236	23.00 x 5.00	30821	24.00 x 3.80
				33680	22.00 x 4.10	36387	23.00 x 5.50	30227	24.00 x 3.80
				36416	22.00 x 4.30	32564	23.00 x 6.00	30861	24.00 x 4.00
				30981	22.00 x 4.50	34674	23.00 x 6.30	33279	24.00 x 4.00
				32531	22.00 x 4.50	34674	23.00 x 6.30	32361	24.00 x 4.15
				34079	22.00 x 4.80	35119	23.00 x 6.50	30982	24.00 x 4.50
				31056	22.00 x 5.00	32709	23.00 x 8.00	34696	24.00 x 4.50
				34272	22.00 x 6.00	33911	23.00 x 9.00	32018	24.00 x 5.00





# Anéis



INCOVE VEDAÇÕES LTDA.

Cód.	Di x Esp.	Cód.	Di x Esp.	Cód.	Di x Esp.	Cód.	Di x Esp.	Cód.	Di x Esp.
32018	24.00 x 5.00	30258	25.00 x 2.50	33059	25.50 x 2.50	30650	26.60 x 3.50	30263	28.00 x 2.50
32018	24.00 x 5.00	32948	25.00 x 2.80	30539	25.50 x 3.00	33983	26.60 x 6.75	32650	28.00 x 2.80
31214	24.00 x 5.50	32948	25.00 x 2.80	30539	25.50 x 3.00	31616	26.64 x 2.62	32650	28.00 x 2.80
32334	24.00 x 5.50	30387	25.00 x 3.00	30647	25.50 x 3.50	35171	26.64 x 2.62	30394	28.00 x 3.00
34711	24.00 x 5.50	30388	25.00 x 3.00	35154	25.50 x 5.53	31616	26.64 x 2.62	33518	28.00 x 3.00
34519	24.00 x 6.00	33395	25.00 x 3.00	31457	25.50 x 7.50	31573	26.70 x 1.78	30555	28.00 x 3.20
31288	24.00 x 6.00	30387	25.00 x 3.00	30551	25.60 x 3.20	34360	26.70 x 1.78	32086	28.00 x 3.30
34707	24.00 x 6.00	30645	25.00 x 3.50	31349	25.70 x 6.10	34360	26.70 x 1.78	30653	28.00 x 3.50
35134	24.00 x 7.00	30645	25.00 x 3.50	32110	25.90 x 3.60	31573	26.70 x 1.78	30654	28.00 x 3.50
33208	24.00 x 8.00	32570	25.00 x 3.50	33408	26.00 x 1.00	34377	26.85 x 2.10	30653	28.00 x 3.50
35135	24.00 x 9.00	34691	25.00 x 3.50	35155	26.00 x 1.50	35172	26.99 x 2.25	30866	28.00 x 4.00
31507	24.00 x 9.30	34691	25.00 x 3.50	30085	26.00 x 1.80	31926	27.00 x 1.50	33699	28.00 x 4.00
36821	24.00 x 13.00	30863	25.00 x 4.00	33663	26.00 x 1.80	31926	27.00 x 1.50	34211	28.00 x 4.50
34493	24.20 x 3.00	30863	25.00 x 4.00	30147	26.00 x 2.00	31926	27.00 x 1.50	34211	28.00 x 4.50
35136	24.21 x 4.76	34753	25.00 x 4.50	32701	26.00 x 2.00	30148	27.00 x 2.00	32935	28.00 x 5.00
35137	24.24 x 2.62	32744	25.00 x 4.50	30190	26.00 x 2.30	30148	27.00 x 2.00	32606	28.00 x 5.40
31414	24.30 x 7.00	31059	25.00 x 5.00	30260	26.00 x 2.50	30148	27.00 x 2.00	34265	28.00 x 6.00
35138	24.40 x 7.50	31059	25.00 x 5.00	30260	26.00 x 2.50	30261	27.00 x 2.50	35179	28.00 x 8.20
36485	24.50 x 2.00	31060	25.00 x 5.50	35156	26.00 x 2.50	33557	27.00 x 2.50	31907	28.00 x 8.25
30256	24.50 x 2.50	31215	25.00 x 5.50	30260	26.00 x 2.50	31902	27.00 x 2.70	33295	28.00 x 8.25
33081	24.50 x 2.50	31060	25.00 x 5.50	30390	26.00 x 3.00	30392	27.00 x 3.00	35180	28.00 x 10.00
30331	24.50 x 2.80	32097	25.00 x 6.50	30390	26.00 x 3.00	34765	27.00 x 3.00	30738	28.17 x 3.53
34790	24.50 x 2.80	34744	25.00 x 7.00	30552	26.00 x 3.20	30553	27.00 x 3.20	31680	28.17 x 3.53
30386	24.50 x 3.00	32799	25.00 x 7.00	30648	26.00 x 3.50	31920	27.00 x 3.20	32067	28.17 x 3.53
30550	24.50 x 3.20	31456	25.00 x 7.50	30806	26.00 x 3.70	30651	27.00 x 3.50	32936	28.17 x 3.53
30550	24.50 x 3.20	31455	25.00 x 7.50	30806	26.00 x 3.80	30651	27.00 x 3.50	31680	28.17 x 3.53
30643	24.50 x 3.50	35144	25.00 x 10.00	30864	26.00 x 4.00	32651	27.00 x 3.80	32830	28.20 x 2.00
35138	24.50 x 3.70	32818	25.04 x 2.95	35157	26.00 x 4.00	30865	27.00 x 4.00	31617	28.24 x 2.62
33429	24.50 x 4.30	31615	25.07 x 2.62	34335	26.00 x 4.70	32994	27.00 x 4.00	35181	28.24 x 2.62
33774	24.50 x 5.00	32043	25.07 x 2.62	35158	26.00 x 4.76	30984	27.00 x 4.50	31617	28.24 x 2.62
30779	24.60 x 3.60	36339	25.07 x 2.62	35159	26.00 x 4.80	31061	27.00 x 5.00	31574	28.30 x 1.78
33879	24.60 x 6.00	32152	25.10 x 2.70	33554	26.00 x 5.00	31062	27.00 x 5.00	31574	28.30 x 1.78
33789	24.61 x 1.59	31572	25.12 x 1.78	31282	26.00 x 5.90	31061	27.00 x 5.00	30086	28.30 x 1.80
35139	24.61 x 3.18	30066	25.12 x 1.78	35160	26.00 x 6.00	31289	27.00 x 6.00	30086	28.30 x 1.80
35140	24.61 x 6.35	31572	25.12 x 1.78	31378	26.00 x 6.35	35173	27.00 x 6.50	30086	28.30 x 1.80
32108	24.70 x 3.00	31572	25.12 x 1.78	35161	26.00 x 6.70	36870	27.10 x 1.78	30230	28.30 x 3.53
35141	24.77 x 5.33	35146	25.20 x 3.30	31458	26.00 x 7.50	30438	27.30 x 2.40	35183	28.40 x 1.60
35142	24.77 x 5.33	_____	25.30 x 2.40	32786	26.00 x 8.00	30438	27.30 x 2.40	30655	28.40 x 3.50
32103	24.80 x 3.60	31393	25.30 x 6.90	35162	26.10 x 2.80	32856	27.30 x 3.50	30395	28.50 x 3.00
32103	24.80 x 3.60	33822	25.40 x 1.40	32249	26.19 x 2.78	33387	27.30 x 4.40	30557	28.50 x 3.20
32091	24.90 x 1.70	30034	25.40 x 1.59	35163	26.19 x 3.18	33487	27.50 x 1.50	31959	28.50 x 3.50
32099	24.90 x 3.50	35147	25.40 x 2.00	33000	26.20 x 3.00	35174	27.50 x 2.00	30656	28.50 x 3.50
30644	24.90 x 3.50	33872	25.40 x 2.80	34745	26.20 x 3.00	35175	27.50 x 2.00	30867	28.50 x 4.00
31678	24.99 x 3.53	35148	25.40 x 3.20	33008	26.20 x 3.60	30262	27.50 x 2.50	35184	28.50 x 10.00
36346	24.99 x 3.53	36929	25.40 x 3.50	31283	26.20 x 5.90	30393	27.50 x 3.00	30035	28.57 x 1.59
33636	25.00 x 1.50	33202	25.40 x 4.00	35164	26.20 x 8.20	30393	27.50 x 3.00	30035	28.57 x 1.59
33636	25.00 x 1.50	33202	25.40 x 4.00	35165	26.24 x 2.62	30652	27.50 x 3.50	32928	28.57 x 2.38
33118	25.00 x 2.00	35149	25.40 x 4.30	33570	26.30 x 2.40	30652	27.50 x 3.50	30838	28.57 x 3.97
33118	25.00 x 2.00	35150	25.40 x 4.70	35166	26.30 x 3.00	30652	27.50 x 3.50	31357	28.57 x 6.35
33118	25.00 x 2.00	35151	25.40 x 7.40	35167	26.30 x 4.00	30652	27.50 x 3.50	35185	28.58 x 2.78
31955	25.00 x 2.20	35152	25.40 x 9.53	32050	26.34 x 5.33	32122	27.50 x 4.00	35186	28.58 x 4.76
31775	25.00 x 2.20	31523	25.40 x 11.11	35168	26.34 x 5.33	33243	27.50 x 4.70	33909	28.60 x 3.80
34218	25.00 x 2.40	35153	25.50 x 1.00	36375	26.50 x 2.00	30554	27.60 x 3.20	35188	28.60 x 4.30
30258	25.00 x 2.50	33209	25.50 x 1.75	_____	26.50 x 2.40	30780	27.80 x 3.60	34597	28.70 x 1.65
31956	25.00 x 2.50	30259	25.50 x 2.50	30391	26.50 x 3.00	30822	27.80 x 3.80	35189	28.70 x 4.00
33215	26.50 x 3.20	34189	27.94 x 1.27	33215	26.50 x 3.20	35176	27.94 x 5.33	32778	28.80 x 12.70
33215	26.50 x 3.20	35176	27.94 x 5.33	33323	26.50 x 5.00	35178	27.94 x 5.33	34349	29.00 x 0.80
33323	26.50 x 5.00	35176	27.94 x 5.33	31415	26.50 x 7.00	35176	27.94 x 5.33	36468	29.00 x 1.50
31415	26.50 x 7.00	36908	28.00 x 1.00	31679	26.57 x 3.53	33264	28.00 x 1.50	30150	29.00 x 2.00
35169	26.57 x 3.53	33264	28.00 x 1.50	31679	26.57 x 3.53	33264	28.00 x 1.50	30150	29.00 x 2.00
31679	26.57 x 3.53	30264	29.00 x 2.50	32817	26.59 x 2.95	36484	28.00 x 1.70	32738	29.00 x 2.00
32817	26.59 x 2.95	30264	29.00 x 2.50	35170	26.59 x 2.95	30149	28.00 x 2.00	30264	29.00 x 2.50
35170	26.59 x 2.95	33015	29.00 x 2.50	32525	26.60 x 2.60	32411	28.00 x 2.00	33015	29.00 x 2.50
32525	26.60 x 2.60	32737	29.00 x 2.80	34472	26.60 x 2.60	32411	28.00 x 2.00	32737	29.00 x 2.80
34472	26.60 x 2.60	32494	29.00 x 2.80	30649	26.60 x 3.50	30263	28.00 x 2.50	32494	29.00 x 2.80
30649	26.60 x 3.50	30396	29.00 x 3.00					30396	29.00 x 3.00





# Anéis



INCOVE VEDAÇÕES LTDA.

Cód.	Di x Esp.	Cód.	Di x Esp.	Cód.	Di x Esp.	Cód.	Di x Esp.	Cód.	Di x Esp.
30396	29.00 x 3.00	36846	30.00 x 1.50	35206	30.96 x 1.77	30840	31.75 x 3.97	32254	33.00 x 3.20
30396	29.00 x 3.00	36846	30.00 x 1.50	32359	30.96 x 4.00	31906	31.75 x 7.93	30671	33.00 x 3.50
32638	29.00 x 3.20	32202	30.00 x 2.00	35207	30.98 x 1.78	35218	31.75 x 14.29	32047	33.00 x 3.50
30657	29.00 x 3.50	34712	30.00 x 2.00	36498	31.00 x 1.10	32292	31.80 x 3.60	34162	33.00 x 3.60
30657	29.00 x 3.50	34712	30.00 x 2.00	36384	31.00 x 1.50	36320	32.00 x 1.50	33286	33.00 x 4.00
30657	29.00 x 3.50	36417	30.00 x 2.20	30087	31.00 x 1.80	36462	32.00 x 1.50	33286	33.00 x 4.00
33640	29.00 x 3.80	35198	30.00 x 2.40	31875	31.00 x 2.00	30152	32.00 x 2.00	35227	33.00 x 4.40
30868	29.00 x 4.00	30338	30.00 x 2.50	32058	31.00 x 2.00	33573	32.00 x 2.00	33392	33.00 x 4.50
33552	29.00 x 4.00	30338	30.00 x 2.50	32058	31.00 x 2.00	30268	32.00 x 2.50	34806	33.00 x 5.00
30985	29.00 x 4.50	33246	30.00 x 2.50	30267	31.00 x 2.50	30318	32.00 x 2.70	34806	33.00 x 5.00
31063	29.00 x 5.00	30398	30.00 x 3.00	33589	31.00 x 2.50	30404	32.00 x 3.00	34100	33.00 x 5.33
31216	29.00 x 5.50	32507	30.00 x 3.00	30267	31.00 x 2.50	32897	32.00 x 3.00	31291	33.00 x 6.00
35190	29.00 x 5.70	32507	30.00 x 3.00	34147	31.00 x 2.80	31962	32.00 x 3.00	31578	33.05 x 1.78
32789	29.00 x 8.00	30559	30.00 x 3.20	32998	31.00 x 2.80	30564	32.00 x 3.20	34374	33.05 x 1.78
36295	29.10 x 1.60	30559	30.00 x 3.20	30402	31.00 x 3.00	30564	32.00 x 3.20	34374	33.05 x 1.78
30740	29.17 x 3.53	30662	30.00 x 3.50	33506	31.00 x 3.00	30668	32.00 x 3.50	32077	33.05 x 1.78
30807	29.20 x 3.70	30215	30.00 x 3.50	30562	31.00 x 3.20	33462	32.00 x 3.50	31578	33.05 x 1.78
35191	29.40 x 3.50	30662	30.00 x 3.50	30666	31.00 x 3.50	32311	32.00 x 3.80	31964	33.05 x 2.62
30265	29.50 x 2.50	32054	30.00 x 3.50	30666	31.00 x 3.50	30871	32.00 x 4.00	33895	33.20 x 0.90
33079	29.50 x 2.50	30869	30.00 x 4.00	30666	31.00 x 3.50	30871	32.00 x 4.00	35228	33.20 x 5.60
33553	29.50 x 3.00	30869	30.00 x 4.00	34016	31.00 x 4.00	30975	32.00 x 4.30	32518	33.30 x 1.30
30558	29.50 x 3.20	30986	30.00 x 4.50	35208	31.00 x 4.50	30987	32.00 x 4.50	30841	33.34 x 3.97
32647	29.50 x 3.20	30986	30.00 x 4.50	35209	31.00 x 4.60	31065	32.00 x 5.00	30783	33.40 x 3.60
30659	29.50 x 3.50	34577	30.00 x 5.00	31035	31.00 x 4.80	32792	32.00 x 5.00	30269	33.50 x 2.50
30659	29.50 x 3.50	31064	30.00 x 5.00	34263	31.00 x 5.00	31218	32.00 x 5.50	30407	33.50 x 3.00
33926	29.50 x 5.00	36896	30.00 x 5.00	34263	31.00 x 5.00	32360	32.00 x 5.70	35229	33.50 x 3.00
32117	29.50 x 5.00	33111	30.00 x 5.50	34291	31.00 x 6.00	_____	32.00 x 6.00	32763	33.50 x 3.25
31217	29.50 x 5.50	31290	30.00 x 6.00	31380	31.00 x 6.50	33929	32.00 x 6.00	30673	33.50 x 3.50
33520	29.50 x 5.50	34343	30.00 x 7.00	35210	31.00 x 6.50	32133	32.00 x 6.50	31066	33.50 x 3.50
35192	29.51 x 5.33	31466	30.00 x 7.94	35211	31.00 x 10.00	35219	32.00 x 10.00	34339	33.50 x 4.00
35193	29.51 x 5.33	31513	30.00 x 10.00	34499	31.00 x 18.50	35220	32.15 x 6.35	33407	33.50 x 5.25
35192	29.51 x 5.33	35199	30.10 x 1.78	35212	31.12 x 5.33	31086	32.20 x 3.00	33427	33.70 x 3.50
30397	29.70 x 3.00	35200	30.16 x 1.59	35213	31.12 x 5.33	33675	32.20 x 3.00	31040	33.70 x 4.90
32276	29.70 x 3.75	35201	30.16 x 3.18	35212	31.12 x 5.33	33675	32.20 x 3.00	31966	33.78 x 12.70
30823	29.70 x 3.80	30839	30.16 x 3.97	31039	31.20 x 4.90	31924	32.30 x 4.70	34504	33.80 x 1.20
34526	29.70 x 8.00	31917	30.16 x 4.50	31960	31.30 x 3.50	30824	32.40 x 3.80	35231	33.80 x 3.00
32813	29.74 x 2.95	33894	30.20 x 3.00	30664	31.30 x 3.50	33146	32.50 x 1.50	32588	34.00 x 2.00
35195	29.74 x 2.95	33894	30.20 x 3.00	31682	31.34 x 3.53	30405	32.50 x 3.00	34579	34.00 x 2.00
31681	29.74 x 3.53	33010	30.20 x 3.50	30744	31.34 x 3.53	30565	32.50 x 3.20	30270	34.00 x 2.50
32234	29.74 x 3.53	35202	30.20 x 5.70	32184	31.34 x 3.53	30669	32.50 x 3.50	30270	34.00 x 2.50
30741	29.74 x 3.53	_____	30.30 x 2.40	36347	31.34 x 3.53	30669	32.50 x 3.50	30408	34.00 x 3.00
30742	29.74 x 3.53	35203	30.30 x 4.00	35214	31.35 x 6.99	30971	32.50 x 4.20	32995	34.00 x 3.00
31681	29.74 x 3.53	33668	30.40 x 3.80	31619	31.42 x 2.62	35221	32.50 x 4.30	30566	34.00 x 3.20
31681	29.74 x 3.53	30151	30.50 x 2.00	35215	31.42 x 2.62	31934	32.69 x 5.33	36940	34.00 x 3.50
35196	29.80 x 7.50	30266	30.50 x 2.50	36340	31.42 x 2.62	35222	32.69 x 5.33	30681	34.00 x 3.50
31618	29.82 x 2.62	30400	30.50 x 3.00	31577	31.47 x 1.78	31694	32.69 x 5.33	30681	34.00 x 3.50
35197	29.82 x 2.62	30663	30.50 x 3.50	31577	31.47 x 1.78	34249	32.90 x 2.60	30681	34.00 x 3.50
31618	29.82 x 2.62	30808	30.50 x 3.70	30067	31.47 x 1.78	34749	32.92 x 3.53	30809	34.00 x 3.70
34072	29.87 x 1.78	30808	30.50 x 3.70	31577	31.47 x 1.78	31683	32.92 x 3.53	30873	34.00 x 4.00
31575	29.87 x 1.78	32168	30.50 x 5.00	30025	31.50 x 1.50	31683	32.92 x 3.53	30873	34.00 x 4.00
34072	29.87 x 1.78	33730	30.50 x 8.00	30068	31.50 x 1.78	31683	32.92 x 3.53	30988	34.00 x 4.50
34072	29.87 x 1.78	30560	30.60 x 3.20	_____	31.50 x 2.60	35224	32.94 x 6.35	33355	34.00 x 4.50
34588	30.00 x 1.00	30782	30.60 x 3.60	36306	31.50 x 2.70	35225	32.94 x 6.99	31068	34.00 x 5.00
34073	30.00 x 1.00	35205	30.80 x 3.60	36306	31.50 x 2.70	31620	32.99 x 2.62	31068	34.00 x 5.00
34481	30.00 x 1.20	32857	30.80 x 3.70	36306	31.50 x 2.70	30309	32.99 x 2.62	31219	34.00 x 5.50
30403	31.50 x 3.00	30403	31.50 x 3.00	31620	32.99 x 2.62	35232	34.00 x 5.70		
32226	31.50 x 4.00	32226	31.50 x 4.00	33276	33.00 x 1.50	35233	34.00 x 6.00		
33359	31.50 x 4.00	33359	31.50 x 4.00	33276	33.00 x 1.50	35234	34.00 x 7.80		
32119	31.50 x 4.00	33266	33.00 x 2.00	30153	33.00 x 2.00	32798	34.00 x 8.00		
30563	31.60 x 3.20	30153	33.00 x 2.00	35235	34.10 x 3.30				
34748	31.60 x 3.20	30784	34.10 x 3.60						
30028	31.70 x 1.59	35236	34.13 x 0.79						
30197	31.70 x 2.38	35237	34.13 x 8.33						
33874	31.70 x 3.50	30270	34.20 x 2.50						
31961	31.75 x 3.17	30409	34.20 x 3.00						
30514	31.75 x 3.17	33378	33.00 x 3.00	33981	34.20 x 3.00				
35216	31.75 x 3.53	32129	33.00 x 3.00	30410	34.20 x 3.00				





# Anéis



INCOVE VEDAÇÕES LTDA.

Cód.	Di	x	Esp.	Cód.	Di	x	Esp.	Cód.	Di	x	Esp.	Cód.	Di	x	Esp.	Cód.	Di	x	Esp.
31967	34.29	x	5.33	31970	35.00	x	3.50	32545	36.00	x	9.00	31748	37.47	x	5.33	30573	38.50	x	3.20
31896	34.29	x	5.33	33667	35.00	x	3.75	32784	36.00	x	10.00	30417	37.50	x	3.00	33405	38.50	x	3.50
35238	34.29	x	5.33	33280	35.00	x	3.75	31685	36.09	x	3.53	30417	37.50	x	3.00	35274	38.50	x	3.97
35238	34.29	x	5.33	33652	35.00	x	3.80	31685	36.09	x	3.53	30417	37.50	x	3.00	31012	38.50	x	4.70
34285	34.40	x	3.10	30874	35.00	x	4.00	32312	36.09	x	3.53	30571	37.50	x	3.20	31905	38.50	x	5.70
34285	34.40	x	3.10	30874	35.00	x	4.00	31685	36.09	x	3.53	32160	37.50	x	3.35	35275	38.50	x	6.35
35239	34.42	x	2.95	32404	35.00	x	4.00	36329	36.09	x	3.53	30679	37.50	x	3.50	35276	38.60	x	2.00
35240	34.42	x	2.95	33088	35.00	x	4.50	33965	36.12	x	8.25	30769	37.50	x	3.55	33310	38.60	x	3.80
33274	34.50	x	3.00	33088	35.00	x	4.50	31622	36.16	x	2.62	34391	37.50	x	4.70	31220	38.60	x	5.50
33274	34.50	x	3.00	34618	35.00	x	5.00	31971	36.16	x	2.62	32869	37.50	x	5.30	32779	38.70	x	12.70
30567	34.50	x	3.20	31069	35.00	x	5.00	35257	36.17	x	2.32	31686	37.69	x	3.53	30151	38.89	x	3.17
30447	34.50	x	3.50	34618	35.00	x	5.00	31622	36.17	x	2.62	31973	37.69	x	3.53	30774	38.89	x	3.57
31968	34.50	x	3.53	33631	35.00	x	5.40	35258	36.17	x	2.62	36330	37.69	x	3.53	35281	39.00	x	1.50
30745	34.50	x	3.53	31292	35.00	x	6.00	31622	36.17	x	2.62	34453	37.70	x	3.00	30158	39.00	x	2.00
32290	34.50	x	3.60	32705	35.00	x	7.00	34023	36.20	x	3.00	35269	37.70	x	10.00	30158	39.00	x	2.00
31969	34.50	x	4.00	35250	35.00	x	8.00	35259	36.22	x	1.78	31623	37.71	x	2.62	39.00	x	2.50	
31893	34.50	x	4.00	35251	35.00	x	9.50	30598	36.30	x	3.30	34090	37.77	x	2.62	34479	39.00	x	3.00
33394	34.50	x	4.50	32544	35.00	x	10.00	33986	36.31	x	5.70	31623	37.77	x	2.62	34479	39.00	x	3.00
35241	34.50	x	4.80	32666	35.20	x	4.15	31913	36.50	x	1.70	34090	37.77	x	2.62	30574	39.00	x	3.20
33437	34.50	x	5.30	31381	35.30	x	6.50	30273	36.50	x	2.50	31623	37.77	x	2.62	30574	39.00	x	3.20
33375	34.50	x	9.50	35252	35.30	x	7.80	36944	36.50	x	2.50	31148	37.80	x	5.30	33262	39.00	x	3.20
35242	34.50	x	10.00	33089	35.40	x	3.90	30415	36.50	x	3.00	31580	37.82	x	1.78	35277	39.00	x	3.50
30746	34.52	x	3.53	33281	35.40	x	5.30	32624	36.50	x	3.00	35270	37.82	x	1.78	35277	39.00	x	3.50
31684	34.52	x	3.53	35253	35.40	x	5.50	30569	36.50	x	3.20	31580	37.82	x	1.78	32081	39.00	x	4.00
32241	34.52	x	3.53	33179	35.50	x	1.50	30677	36.50	x	3.50	30157	38.00	x	2.00	33028	39.00	x	4.00
31684	34.52	x	3.53	30272	35.50	x	2.50	33091	36.50	x	4.50	32697	38.00	x	2.00	33325	39.00	x	4.30
35245	34.53	x	6.35	32840	35.50	x	2.60	32385	36.50	x	5.00	30276	38.00	x	2.50	33622	39.00	x	4.50
31621	34.59	x	2.62	34604	35.50	x	2.60	33423	36.50	x	5.30	30275	38.00	x	2.50	31149	39.00	x	5.30
35246	34.59	x	2.62	30413	35.50	x	3.00	34191	36.50	x	5.50	30319	38.00	x	2.70	35278	39.00	x	6.00
36341	34.59	x	2.62	30568	35.50	x	3.20	35260	36.50	x	6.00	30319	38.00	x	2.70	32543	39.00	x	9.00
36300	34.60	x	1.20	30676	35.50	x	3.50	35261	36.50	x	7.50	33876	38.00	x	2.70	32785	39.00	x	10.00
31579	34.65	x	1.78	34194	35.50	x	4.20	35262	36.51	x	6.35	30418	38.00	x	3.00	33406	39.10	x	6.40
33759	34.65	x	1.78	30785	35.60	x	3.60	34789	36.80	x	2.70	30418	38.00	x	3.00	30420	39.20	x	3.00
31579	34.65	x	1.78	30097	35.80	x	1.95	33053	37.00	x	1.50	30418	38.00	x	3.00	32649	39.20	x	3.00
31876	34.92	x	3.00	34047	36.00	x	1.00	30156	37.00	x	2.00	30572	38.00	x	3.20	33162	39.20	x	3.00
31358	34.92	x	6.35	35255	36.00	x	1.20	30156	37.00	x	2.00	32651	38.00	x	3.20	31974	39.20	x	5.70
34229	34.93	x	1.58	36950	36.00	x	1.50	30156	37.00	x	2.00	30572	38.00	x	3.20	35280	39.34	x	1.60
35248	34.93	x	4.25	36950	36.00	x	1.50	33317	37.00	x	2.20	32768	38.00	x	3.50	31624	39.34	x	2.62
33052	35.00	x	1.50	30155	36.00	x	2.00	30274	37.00	x	2.50	33624	38.00	x	3.50	35282	39.34	x	2.62
30052	35.00	x	1.70	34660	36.00	x	2.00	34646	37.00	x	2.50	34628	38.00	x	3.50	31624	39.34	x	2.62
30052	35.00	x	1.70	35256	36.00	x	2.50	30416	37.00	x	3.00	30875	38.00	x	4.00	35283	39.40	x	4.30
34713	35.00	x	2.00	35256	36.00	x	2.50	32586	37.00	x	3.00	30875	38.00	x	4.00	35284	39.45	x	1.78
34713	35.00	x	2.00	35256	36.00	x	2.50	30416	37.00	x	3.00	32224	38.00	x	4.00	30191	39.50	x	2.30
34713	35.00	x	2.00	32989	36.00	x	2.70	30570	37.00	x	3.20	33056	38.00	x	4.50	30191	39.50	x	2.30
34441	35.00	x	2.20	30414	36.00	x	3.00	30678	37.00	x	3.50	33056	38.00	x	4.50	32139	39.50	x	3.50
34441	35.00	x	2.20	33548	36.00	x	3.00	33637	37.00	x	3.50	31072	38.00	x	5.00	34122	39.60	x	5.30
30271	35.00	x	2.50	33548	36.00	x	3.00	30786	37.00	x	3.60	32028	38.00	x	5.00	32268	39.69	x	1.59
32084	35.00	x	2.50	32496	36.00	x	4.00	34475	37.00	x	4.00	31072	38.00	x	5.00	34610	39.69	x	3.53
35249	35.00	x	2.60	32496	36.00	x	4.00	34475	37.00	x	4.00	31887	38.00	x	6.00	34521	39.69	x	3.53
30332	35.00	x	2.80	34078	36.00	x	4.50	31071	37.00	x	5.00	32993	38.00	x	6.00	35285	39.69	x	7.14
30412	35.00	x	3.00	34078	36.00	x	4.50	35263	37.00	x	5.20	35271	38.00	x	6.50	35286	39.70	x	2.20
30412	35.00	x	3.00	31070	36.00	x	5.00	35264	37.00	x	5.50	30737	38.00	x	6.70	32175	39.70	x	4.00
30411	35.00	x	3.00	31293	36.00	x	6.00	34193	37.00	x	6.00	34452	38.00	x	7.00	35287	39.70	x	9.60
36419	35.00	x	3.30	31293	36.00	x	6.00	34193	37.00	x	6.00	34452	38.00	x	7.00	F14782	40.00	x	0.00
30944	35.00	x	3.50	31468	36.00	x	8.00	35264	37.00	x	6.50	34480	38.00	x	8.00	30658	40.00	x	1.20
								33505	37.00	x	7.00	34480	38.00	x	8.00	33611	40.00	x	1.20
								35265	37.00	x	8.00	33608	38.10	x	1.58	30026	40.00	x	1.50
								31526	37.00	x	13.00	33608	38.10	x	1.58	30026	40.00	x	1.50
								35266	37.00	x	14.00	33860	38.10	x	4.70	35288	40.00	x	1.60
								33756	37.00	x	15.00	31073	38.10	x	5.00	34487	40.00	x	1.80
								34446	37.20	x	4.55	33366	38.10	x	5.50	32075	40.00	x	2.00
								31892	37.30	x	3.60	31359	38.10	x	6.35	32075	40.00	x	2.00
								35267	37.30	x	12.70	35272	38.10	x	6.75	34050	40.00	x	2.20
								31972	37.40	x	5.50	31416	38.10	x	7.00	30277	40.00	x	2.50
								32814	37.47	x	3.00	30605	38.20	x	3.40	33416	40.00	x	2.50
								31748	37.47	x	5.33	35273	38.50	x	1.00	34454	40.00	x	2.70
								32171	37.47	x	5.33	30419	38.50	x	3.00	34454	40.00	x	2.70







# Anéis



INCOVE VEDAÇÕES LTDA.

Cód.	Di x Esp.	Cód.	Di x Esp.	Cód.	Di x Esp.	Cód.	Di x Esp.	Cód.	Di x Esp.	Cód.	Di x Esp.
30421	40.00 x 3.00	31625	40.94 x 2.62	33223	42.00 x 3.78	32093	43.94 x 1.78	30162	45.00 x 2.00		
30421	40.00 x 3.00	32848	40.94 x 2.62	30878	42.00 x 4.00	32093	43.94 x 1.78	30162	45.00 x 2.00		
30421	40.00 x 3.00	31625	40.94 x 2.62	34642	42.00 x 4.00	30161	44.00 x 2.00	33168	45.00 x 2.50		
30575	40.00 x 3.20	33742	40.99 x 1.20	30878	42.00 x 4.00	30161	44.00 x 2.00	33168	45.00 x 2.50		
31547	40.00 x 3.50	30027	41.00 x 1.50	31977	42.00 x 4.50	33398	44.00 x 2.00	34315	45.00 x 2.80		
32550	40.00 x 3.50	31581	41.00 x 1.78	33461	42.00 x 4.70	36438	44.00 x 2.50	30428	45.00 x 3.00		
31547	40.00 x 3.50	31581	41.00 x 1.78	31075	42.00 x 5.00	32275	44.00 x 2.62	32368	45.00 x 3.00		
36831	40.00 x 3.80	32159	41.00 x 1.78	32185	42.00 x 5.00	32695	44.00 x 2.62	30586	45.00 x 3.20		
30876	40.00 x 4.00	31581	41.00 x 1.78	33597	42.00 x 5.20	30425	44.00 x 3.00	30586	45.00 x 3.20		
30876	40.00 x 4.00	34084	41.00 x 1.80	34434	42.00 x 5.50	32603	44.00 x 3.00	30586	45.00 x 3.20		
30976	40.00 x 4.30	32069	41.00 x 2.00	32757	42.00 x 6.00	33119	44.00 x 3.00	31904	45.00 x 3.30		
33182	40.00 x 4.50	32069	41.00 x 2.00	32101	42.00 x 6.00	30579	44.00 x 3.20	30682	45.00 x 3.50		
31975	40.00 x 4.80	36317	41.00 x 3.00	32253	42.00 x 8.00	30877	44.00 x 3.50	34702	45.00 x 4.00		
33814	40.00 x 4.80	36317	41.00 x 3.00	34299	42.00 x 9.00	30681	44.00 x 3.50	30990	45.00 x 4.50		
31074	40.00 x 5.00	32911	41.00 x 3.50	34299	42.00 x 9.00	32383	44.00 x 3.50	31781	45.00 x 5.00		
32720	40.00 x 5.00	32911	41.00 x 3.50	34311	42.00 x 14.00	32979	44.00 x 3.70	34476	45.00 x 5.00		
32720	40.00 x 5.00	30973	41.00 x 4.20	32163	42.00 x 15.00	30879	44.00 x 4.00	32173	45.00 x 5.30		
34205	40.00 x 5.50	30989	41.00 x 4.50	30423	42.20 x 3.00	34689	44.00 x 4.00	32512	45.00 x 5.50		
36887	40.00 x 6.00	31886	41.00 x 5.00	30423	42.20 x 3.00	31077	44.00 x 5.00	32512	45.00 x 5.50		
31294	40.00 x 6.00	32444	41.00 x 5.00	32740	42.20 x 3.00	31205	44.00 x 5.35	32512	45.00 x 5.50		
31360	40.00 x 6.35	31222	41.00 x 5.50	35306	42.40 x 6.10	31205	44.00 x 5.35	31296	45.00 x 6.00		
33201	40.00 x 6.35	35297	41.00 x 6.00	35307	42.47 x 3.53	31205	44.00 x 5.35	35330	45.00 x 7.00		
32506	40.00 x 6.50	31382	41.00 x 6.50	33439	42.50 x 6.10	30578	44.00 x 5.40	31470	45.00 x 8.00		
34118	40.00 x 7.00	33883	41.08 x 0.90	31626	42.52 x 2.62	31208	44.00 x 5.40	32788	45.00 x 8.00		
34301	40.00 x 7.00	35298	41.20 x 3.80	35308	42.52 x 2.62	31908	44.00 x 6.00	35331	45.00 x 12.00		
31469	40.00 x 8.00	34195	41.20 x 5.70	31626	42.52 x 2.62	31295	44.00 x 6.00	35333	45.20 x 4.30		
35289	40.00 x 10.00	30860	41.27 x 3.00	32174	42.80 x 4.36	30909	44.00 x 6.50	33367	45.40 x 3.60		
35290	40.10 x 7.80	30860	41.27 x 3.00	33901	42.86 x 2.38	32007	44.00 x 6.50	35334	45.40 x 5.80		
31524	40.13 x 12.70	31909	41.27 x 5.54	35309	42.86 x 3.53	34046	44.00 x 9.50	32593	45.50 x 1.50		
30172	40.20 x 2.10	30750	41.28 x 3.53	33537	43.00 x 1.50	35318	44.00 x 10.30	35332	45.50 x 2.00		
32894	40.20 x 3.00	35299	41.28 x 4.76	33751	43.00 x 1.70	31688	44.04 x 3.53	35335	45.50 x 3.50		
32865	40.20 x 5.00	35300	41.28 x 8.00	33739	43.00 x 2.00	35319	44.04 x 3.53	33601	45.50 x 5.00		
33113	40.20 x 7.70	35301	41.30 x 5.30	32728	43.00 x 2.50	31688	44.04 x 3.53	33601	45.50 x 5.00		
35291	40.30 x 1.10	33474	41.40 x 3.90	32728	43.00 x 2.50	35320	44.05 x 8.73	33356	45.60 x 3.20		
30972	40.30 x 4.20	32112	41.50 x 3.20	34750	43.00 x 2.50	31627	44.12 x 2.62	31628	45.69 x 2.62		
35292	40.48 x 3.75	34766	41.50 x 3.20	30424	43.00 x 3.00	35321	44.12 x 2.62	35335	45.69 x 2.62		
32910	40.50 x 3.00	33746	41.50 x 4.00	32384	43.00 x 3.00	31627	44.12 x 2.62	31628	45.69 x 2.62		
36463	40.50 x 4.50	33386	41.50 x 4.70	30680	43.00 x 3.50	31582	44.17 x 1.78	35336	45.80 x 1.60		
31221	40.50 x 5.50	33712	41.50 x 5.00	30680	43.00 x 3.50	35322	44.17 x 1.78	35337	45.80 x 6.50		
33180	40.60 x 4.10	35302	41.67 x 3.18	32144	43.00 x 5.00	31582	44.17 x 1.78	32256	46.00 x 1.80		
31911	40.60 x 5.00	35303	41.70 x 5.00	31223	43.00 x 5.50	30002	44.20 x 0.90	32092	46.00 x 2.00		
31139	40.60 x 5.10	35304	41.80 x 7.00	32628	43.00 x 6.00	31972	44.20 x 3.00	32092	46.00 x 2.00		
31150	40.60 x 5.30	35305	42.00 x 1.50	35310	43.00 x 8.50	32655	44.20 x 3.00	36841	46.00 x 2.20		
31749	40.64 x 5.33	30160	42.00 x 2.00	34742	43.20 x 3.60	30426	44.20 x 3.00	30278	46.00 x 2.50		
31749	40.64 x 5.33	30159	42.00 x 2.00	30787	43.20 x 3.60	31250	44.20 x 5.70	32304	46.00 x 2.50		
31152	40.70 x 5.30	30159	42.00 x 2.00	35311	43.20 x 3.80	31249	44.20 x 5.70	36874	46.00 x 2.80		
31151	40.70 x 5.30	33558	42.00 x 2.50	34805	43.40 x 4.70	35323	44.30 x 7.50	34560	46.00 x 3.00		
31976	40.70 x 5.30	33556	42.00 x 2.50	36444	43.50 x 3.00	35324	44.30 x 9.10	30429	46.00 x 3.00		
33105	40.70 x 5.30	33556	42.00 x 2.50	30576	43.50 x 3.20	34473	44.40 x 3.10	30751	46.00 x 3.53		
32927	40.80 x 2.40	30422	42.00 x 3.00	30577	43.50 x 3.20	34473	44.40 x 3.10	30825	46.00 x 3.80		
32923	40.80 x 3.00	32631	42.00 x 3.00	35312	43.50 x 5.50	31036	44.40 x 4.80	31882	46.00 x 4.00		
31687	40.87 x 3.53	30422	42.00 x 3.00	35313	43.50 x 6.35	34359	44.45 x 1.00	33338	46.00 x 4.50		
36331	40.87 x 3.53	32356	42.00 x 3.50	33438	43.54 x 5.50	35325	44.45 x 2.30	33400	46.00 x 4.50		
34571	40.90 x 3.50	34692	42.00 x 3.50	35314	43.60 x 5.90	35326	44.45 x 3.53	31078	46.00 x 5.00		
34571	40.90 x 3.50	34163	42.00 x 3.60	35315	43.66 x 14.29	32929	44.45 x 4.76	35339	46.00 x 5.70		
32378	43.69 x 3.00	32378	43.69 x 3.00	35327	44.45 x 7.94	31297	46.00 x 6.00				
32804	43.69 x 3.00	32804	43.69 x 3.00	31582	44.47 x 1.78	33528	46.00 x 6.00				
35316	43.70 x 3.20	35316	43.70 x 3.20	31582	44.47 x 1.78	35340	46.02 x 3.18				
33384	43.70 x 3.40	33384	43.70 x 3.40	31582	44.47 x 1.78	33361	46.04 x 6.35				
34136	43.70 x 4.30	34136	43.70 x 4.30	31582	44.47 x 1.78	31361	46.04 x 6.35				
34274	43.80 x 2.60	34274	43.80 x 2.60	35329	44.80 x 2.80	36830	46.20 x 5.30				
31153	43.80 x 5.30	31153	43.80 x 5.30	32822	44.90 x 1.50	33913	46.20 x 12.70				
31153	43.80 x 5.30	31153	43.80 x 5.30	36849	45.00 x 1.00	36487	46.40 x 2.20				
33320	43.80 x 5.30	33320	43.80 x 5.30	36849	45.00 x 1.00	32750	46.50 x 1.20				
31750	43.82 x 5.33	31750	43.82 x 5.33	36914	45.00 x 1.50	31903	46.50 x 3.20				
31750	43.82 x 5.33	31750	43.82 x 5.33	36914	45.00 x 1.50	33628	46.50 x 4.76				
36454	43.90 x 1.60	36454	43.90 x 1.60	30162	45.00 x 2.00	33714	46.50 x 5.70				







# Anéis



INCOVE VEDAÇÕES LTDA.

Cód.	Di x Esp.	Cód.	Di x Esp.	Cód.	Di x Esp.	Cód.	Di x Esp.	Cód.	Di x Esp.
31979	46.80 x 4.80	30795	48.00 x 3.65	31195	49.50 x 3.80	31083	50.80 x 5.00	35381	52.80 x 3.50
35341	46.83 x 2.78	30882	48.00 x 4.00	31038	49.50 x 4.80	35370	50.80 x 6.35	35382	52.80 x 5.30
31751	46.99 x 5.33	32883	48.00 x 4.00	33321	49.50 x 5.30	35371	50.80 x 6.80	36890	53.00 x 1.50
33284	46.99 x 5.33	32678	48.00 x 4.50	30788	49.60 x 3.60	35372	50.80 x 8.00	36374	53.00 x 2.00
31751	46.99 x 5.33	31037	48.00 x 4.80	34755	49.60 x 3.60	35373	50.80 x 12.70	36374	53.00 x 2.00
31751	46.99 x 5.33	32614	48.00 x 5.00	32955	49.60 x 3.60	32135	51.00 x 2.00	35383	53.00 x 2.50
35342	46.99 x 6.99	32731	48.00 x 5.00	35360	49.60 x 6.50	32783	51.00 x 2.50	35383	53.00 x 2.50
36360	47.00 x 1.50	32681	48.00 x 5.50	34372	49.70 x 2.00	32783	51.00 x 2.50	30437	53.00 x 3.00
33671	47.00 x 2.00	33157	48.00 x 6.00	33153	49.70 x 3.50	32783	51.00 x 2.50	30437	53.00 x 3.00
33671	47.00 x 2.00	33157	48.00 x 6.00	35361	49.80 x 4.80	32156	51.00 x 4.00	30869	53.00 x 3.50
30280	47.00 x 2.50	32396	48.00 x 7.00	35362	50.00 x 1.00	32328	51.00 x 4.00	30869	53.00 x 3.50
30430	47.00 x 3.00	32176	48.00 x 8.00	34024	50.00 x 1.30	34051	51.00 x 5.25	30869	53.00 x 3.50
30430	47.00 x 3.00	31515	48.00 x 10.00	32887	50.00 x 1.50	35374	51.00 x 5.50	32347	53.00 x 4.00
30683	47.00 x 3.50	35347	48.02 x 3.25	32887	50.00 x 1.50	31362	51.00 x 6.35	32347	53.00 x 4.00
30881	47.00 x 4.00	35348	48.10 x 2.20	30163	50.00 x 2.00	34025	51.00 x 6.50	33825	53.00 x 4.00
32652	47.00 x 4.00	31203	48.20 x 4.60	30163	50.00 x 2.00	34455	51.00 x 6.50	33130	53.00 x 5.30
32652	47.00 x 4.00	32269	48.50 x 3.00	30163	50.00 x 2.00	34053	51.00 x 7.50	33130	53.00 x 5.30
30991	47.00 x 4.50	35349	48.50 x 6.00	36391	50.00 x 2.50	31471	51.00 x 8.00	34121	53.00 x 5.70
31079	47.00 x 5.00	35350	48.50 x 14.50	36391	50.00 x 2.50	32715	51.00 x 9.00	31300	53.00 x 6.00
31079	47.00 x 5.00	35351	48.80 x 7.50	32265	50.00 x 2.77	32454	51.20 x 5.70	32707	53.00 x 6.00
33093	47.00 x 5.33	31630	48.90 x 2.62	34754	50.00 x 2.77	32278	51.20 x 5.70	34612	53.00 x 6.70
32261	47.00 x 6.50	31630	48.90 x 2.62	30435	50.00 x 3.00	35375	51.40 x 6.00	34123	53.00 x 6.70
35343	47.00 x 7.80	31630	48.90 x 2.62	30435	50.00 x 3.00	51.50 x 2.40	35384	53.00 x 9.50	
35344	47.00 x 10.00	31630	48.90 x 2.62	36361	50.00 x 3.40	30599	51.50 x 3.30	35385	53.00 x 12.00
30752	47.22 x 3.53	31630	48.90 x 2.62	32049	50.00 x 4.00	34529	51.60 x 4.60	32623	53.09 x 3.00
31689	47.22 x 3.53	36439	49.00 x 1.50	32616	50.00 x 4.00	35376	51.70 x 10.00	35386	53.09 x 3.00
32316	47.22 x 3.53	35352	49.00 x 2.00	32282	50.00 x 4.00	34341	52.00 x 1.50	35387	53.18 x 4.76
30752	47.22 x 3.53	30432	49.00 x 3.00	32704	50.00 x 4.50	34341	52.00 x 1.50	31753	53.30 x 5.30
36332	47.22 x 3.53	30432	49.00 x 3.00	32704	50.00 x 4.50	36924	52.00 x 2.00	31753	53.34 x 5.33
31629	47.29 x 2.62	30581	49.00 x 3.20	31082	50.00 x 5.00	36924	52.00 x 2.00	33312	53.34 x 5.33
35345	47.29 x 2.62	30685	49.00 x 3.50	32491	50.00 x 5.30	30281	52.00 x 2.50	31753	53.34 x 5.33
36342	47.29 x 2.62	34764	49.00 x 4.00	32500	50.00 x 5.30	31632	52.00 x 2.50	33565	53.40 x 2.00
36949	47.30 x 4.00	34641	49.00 x 4.00	34590	50.00 x 5.50	30436	52.00 x 3.00	33139	53.40 x 2.00
31583	47.35 x 1.78	30833	49.00 x 4.00	31226	50.00 x 5.50	33539	52.00 x 3.00	32843	53.40 x 3.00
34665	47.35 x 1.78	30117	49.00 x 4.80	31281	50.00 x 5.80	30582	52.00 x 3.20	35389	53.50 x 3.00
34665	47.35 x 1.78	31081	49.00 x 5.00	31298	50.00 x 6.00	30686	52.00 x 3.50	33724	53.50 x 4.75
31583	47.35 x 1.78	35353	49.00 x 5.33	31298	50.00 x 6.00	30686	52.00 x 3.50	31085	53.50 x 5.00
32120	47.50 x 3.00	31224	49.00 x 5.50	32611	50.00 x 6.00	33685	52.00 x 3.80	35390	53.50 x 7.30
31980	47.50 x 3.65	31225	49.00 x 5.50	32068	50.00 x 6.00	30884	52.00 x 4.00	35391	53.55 x 3.00
32636	47.50 x 3.65	32583	49.00 x 5.50	50.00 x 6.50	30884	52.00 x 4.00	31691	53.57 x 3.53	
34220	47.50 x 4.50	34034	49.00 x 6.50	31417	50.00 x 7.00	32672	52.00 x 4.50	30753	53.57 x 3.53
36456	47.50 x 5.50	35354	49.00 x 7.00	35364	50.00 x 9.00	31084	52.00 x 5.00	33169	53.57 x 3.53
32286	47.62 x 2.61	35355	49.00 x 7.00	35365	50.01 x 3.53	33697	52.00 x 5.00	36334	53.57 x 3.53
32286	47.62 x 2.61	35356	49.00 x 10.00	31752	50.17 x 5.33	31084	52.00 x 5.00	31633	53.64 x 2.62
33022	47.63 x 3.20	33036	49.20 x 5.30	30168	50.17 x 5.33	31983	52.00 x 5.35	35392	53.64 x 2.62
30768	47.63 x 3.53	33696	49.20 x 5.30	33315	50.17 x 5.33	31206	52.00 x 5.35	31633	53.64 x 2.62
35346	47.63 x 7.14	31251	49.20 x 5.70	31752	50.17 x 5.33	31984	52.00 x 5.50	30303	53.67 x 2.62
33718	48.00 x 1.50	31251	49.20 x 5.70	36502	50.20 x 3.00	31227	52.00 x 5.50	31585	53.70 x 1.78
33718	48.00 x 1.50	35357	49.20 x 6.20	31690	50.39 x 3.53	31227	52.00 x 5.50	34283	53.70 x 1.78
32421	48.00 x 2.00	33297	49.21 x 1.58	35366	50.39 x 3.53	31299	52.00 x 6.00	31585	53.70 x 1.78
32752	48.00 x 2.20	33752	49.21 x 2.80	36333	50.39 x 3.53	33318	52.00 x 6.00	34057	53.97 x 4.76
36440	48.00 x 2.50	35358	49.21 x 4.76	31981	50.39 x 4.11	34201	52.00 x 6.35	31087	53.97 x 5.00
30431	48.00 x 3.00	30434	49.50 x 3.00	30970	50.39 x 4.11	35377	52.00 x 9.00	31363	53.97 x 6.35
30431	48.00 x 3.00	30433	49.50 x 3.00	32293	50.42 x 5.46	31632	52.07 x 2.62	32990	53.97 x 7.94
30684	48.00 x 3.50	34772	49.50 x 3.00	31631	50.47 x 2.62	35378	52.07 x 2.62	33585	54.00 x 1.00
				35367	50.47 x 2.62	30687	52.10 x 3.50	36880	54.00 x 1.50
				31631	50.47 x 2.62	33519	52.10 x 3.50	36880	54.00 x 1.50
				32634	50.50 x 3.20	31536	52.20 x 5.70	36293	54.00 x 1.80
				35368	50.50 x 4.80	34300	52.20 x 6.80	36882	54.00 x 2.00
				31584	50.52 x 1.78	33625	52.30 x 2.50	33477	54.00 x 2.50
				35369	50.52 x 1.78	35379	52.39 x 3.18	33477	54.00 x 2.50
				31584	50.52 x 1.78	35380	52.39 x 5.56	31985	54.00 x 2.50
				33802	50.60 x 3.53	34201	52.40 x 6.40	31985	54.00 x 2.50
				34337	50.80 x 3.17	32157	52.50 x 3.00	30439	54.00 x 3.00
				30198	50.80 x 3.97	30583	52.50 x 3.20	32741	54.00 x 3.00
				31982	50.80 x 3.97	30688	52.50 x 3.50	30439	54.00 x 3.00
				31019	50.80 x 4.75	34440	52.60 x 1.30	30516	54.00 x 3.17





# Anéis



INCOVE VEDAÇÕES LTDA.

Cód.	Di x Esp.	Cód.	Di x Esp.	Cód.	Di x Esp.	Cód.	Di x Esp.	Cód.	Di x Esp.
30516	54.00 x 3.17	31634	55.25 x 2.62	30299	56.80 x 2.60	30775	58.74 x 3.57	31207	60.00 x 5.35
35393	54.00 x 3.20	35401	55.25 x 2.62	31989	56.80 x 2.60	35419	58.80 x 4.20	35428	60.00 x 5.40
30606	54.00 x 3.40	31634	55.25 x 2.62	30299	56.80 x 2.60	35420	58.80 x 8.00	31994	60.00 x 5.50
30797	54.00 x 3.67	32102	55.50 x 2.50	31635	56.82 x 2.62	36402	59.00 x 1.50	31230	60.00 x 5.50
30886	54.00 x 4.00	32486	55.50 x 2.50	35409	56.82 x 2.62	32095	59.00 x 2.00	32374	60.00 x 6.00
30886	54.00 x 4.00	35402	55.50 x 3.00	31635	56.82 x 2.62	35421	59.00 x 2.00	32338	60.00 x 6.00
30886	54.00 x 4.00	35403	55.50 x 5.00	31586	56.87 x 1.78	33799	59.00 x 2.50	31383	60.00 x 6.50
35394	54.00 x 5.50	32708	55.50 x 7.00	31586	56.87 x 1.78	33799	59.00 x 2.50	32161	60.00 x 8.00
31284	54.00 x 5.90	30031	55.56 x 1.59	31586	56.87 x 1.78	32071	59.00 x 3.00	33457	60.00 x 8.00
31301	54.00 x 6.00	30755	55.56 x 3.53	33035	56.90 x 4.90	32071	59.00 x 3.00	32136	60.00 x 8.00
34535	54.00 x 7.00	33277	55.56 x 3.53	35410	57.00 x 1.20	32071	59.00 x 3.00	32172	60.00 x 10.00
31576	54.00 x 17.50	31244	55.56 x 5.56	36876	57.00 x 1.50	30586	59.00 x 3.20	32791	60.00 x 10.00
32207	54.20 x 4.30	32644	55.56 x 5.56	36876	57.00 x 1.50	30692	59.00 x 3.50	35429	60.00 x 16.00
31252	54.20 x 5.70	34250	55.60 x 2.20	30164	57.00 x 2.00	33466	59.00 x 4.50	32087	60.00 x 20.00
32291	54.20 x 5.70	34551	55.60 x 6.35	30164	57.00 x 2.00	33632	59.00 x 5.00	31587	60.05 x 1.78
32542	54.20 x 8.60	35404	55.60 x 10.00	36410	57.00 x 2.50	31229	59.00 x 5.50	34035	60.05 x 1.78
34095	54.30 x 3.00	35405	55.64 x 1.77	36410	57.00 x 2.50	31229	59.00 x 5.50	31587	60.05 x 1.78
33197	54.40 x 5.00	32846	55.70 x 3.00	30442	57.00 x 3.00	30384	59.00 x 9.00	30826	60.20 x 3.00
31209	54.40 x 5.40	35406	55.80 x 1.15	30442	57.00 x 3.00	34026	59.00 x 10.50	30826	60.30 x 3.80
32005	54.50 x 1.50	33783	56.00 x 2.00	32222	57.00 x 4.00	30640	59.20 x 5.70	32930	60.30 x 4.76
34089	54.50 x 3.00	33538	56.00 x 2.00	32222	57.00 x 4.00	30340	59.35 x 2.99	30445	60.50 x 3.00
34271	54.50 x 4.20	32311	56.00 x 2.50	32222	57.00 x 4.00	32808	59.36 x 3.00	33892	60.50 x 3.70
33634	54.50 x 6.00	32311	56.00 x 2.50	32358	57.00 x 4.50	35422	59.36 x 3.00	35430	60.50 x 4.00
33634	54.50 x 6.00	30441	56.00 x 3.00	35411	57.00 x 5.70	35423	59.40 x 1.80	35431	60.50 x 5.50
35395	54.80 x 5.00	30441	56.00 x 3.00	34338	57.15 x 3.18	30334	59.40 x 2.80	35432	60.50 x 9.00
33786	54.80 x 5.50	31987	56.00 x 3.00	34338	57.15 x 3.18	30334	59.40 x 2.80	34528	60.90 x 2.50
35396	54.90 x 5.80	30441	56.00 x 3.00	35412	57.15 x 4.76	30444	59.50 x 3.00	32871	60.90 x 6.00
33086	55.00 x 1.50	32272	56.00 x 3.20	36833	57.15 x 9.53	30444	59.50 x 3.00	31364	60.95 x 6.35
33086	55.00 x 1.50	31988	56.00 x 3.60	31871	57.20 x 5.70	31991	59.50 x 3.50	36420	61.00 x 1.90
35397	55.00 x 1.50	31988	56.00 x 3.60	33688	57.20 x 5.70	30111	59.50 x 3.50	35433	61.00 x 2.00
32420	55.00 x 2.00	30789	56.00 x 3.60	32983	57.20 x 6.00	31229	59.50 x 5.50	30447	61.00 x 3.00
32461	55.00 x 2.00	30889	56.00 x 4.00	32983	57.20 x 6.00	35423	59.53 x 6.35	35434	61.00 x 3.50
32696	55.00 x 2.50	36393	56.00 x 4.50	34287	57.30 x 1.78	33132	59.60 x 5.70	35435	61.00 x 5.70
32696	55.00 x 2.50	31080	56.00 x 5.90	35413	57.50 x 2.00	31755	59.69 x 5.33	35436	61.00 x 8.60
34357	55.00 x 2.50	35407	56.00 x 7.00	33555	58.00 x 2.00	35424	59.69 x 5.33	35437	61.00 x 8.60
31986	55.00 x 2.70	32208	56.20 x 3.00	33846	58.00 x 2.00	36354	59.69 x 5.33	30447	61.10 x 2.40
32765	55.00 x 2.80	35408	56.36 x 5.56	34370	58.00 x 2.50	33070	59.70 x 4.70	33623	61.20 x 5.70
30440	55.00 x 3.00	32749	56.50 x 1.40	34370	58.00 x 2.50	32849	59.90 x 3.00	32906	61.50 x 3.60
30440	55.00 x 3.00	33738	56.50 x 1.50	34609	58.00 x 2.50	31693	59.92 x 3.53	34263	61.50 x 5.00
30584	55.00 x 3.20	34368	56.50 x 5.00	30443	58.00 x 3.00	34802	59.92 x 3.53	31638	61.60 x 2.62
30767	55.00 x 3.50	34368	56.50 x 5.00	30443	58.00 x 3.00	31693	59.92 x 3.53	35439	61.60 x 2.62
30888	55.00 x 4.00	32348	56.50 x 5.50	30585	58.00 x 3.20	31637	59.99 x 2.62	31638	61.60 x 2.62
32770	55.00 x 4.00	32085	56.50 x 5.50	30690	58.00 x 3.50	35425	59.99 x 2.62	35440	61.91 x 6.35
30887	55.00 x 4.00	36378	56.50 x 5.80	30690	58.00 x 3.50	34371	60.00 x 1.50	33609	62.00 x 1.50
30969	55.00 x 4.10	36427	56.50 x 6.10	35414	58.00 x 3.80	34371	60.00 x 1.50	33604	62.00 x 1.50
33674	55.00 x 4.50	31754	56.52 x 5.33	32751	58.00 x 4.00	32522	60.00 x 2.00	36301	62.00 x 1.60
31088	55.00 x 5.00	31169	56.52 x 5.33	33252	58.00 x 5.00	32522	60.00 x 2.00	30165	62.00 x 2.00
32584	55.00 x 5.00	32773	56.52 x 5.33	33369	58.00 x 5.30	32522	60.00 x 2.00	30165	62.00 x 2.00
31142	55.00 x 5.20	31754	56.52 x 5.33	31418	58.00 x 7.00	36406	60.00 x 2.50	36429	62.00 x 2.50
33917	55.00 x 5.50	USINA	56.60 x 3.70	31472	58.00 x 8.00	30334	60.00 x 2.60	30427	62.00 x 3.00
36428	55.00 x 5.80	35408	56.70 x 3.00	34759	58.00 x 10.00	30334	60.00 x 2.60	34656	62.00 x 3.00
35398	55.00 x 6.00	31692	56.74 x 3.53	35415	58.00 x 17.00	31637	60.00 x 2.62	34656	62.00 x 3.00
32305	55.00 x 10.00	31692	56.74 x 3.53	34365	58.00 x 20.00	30333	60.00 x 2.80	30427	62.00 x 3.00
35399	55.00 x 14.00	30890	56.74 x 3.53	32860	58.10 x 4.00	30333	60.00 x 3.00	33885	62.00 x 3.50
35400	55.17 x 3.53	31692	56.74 x 3.53	32863	58.10 x 4.70	31992	60.00 x 3.00	33885	62.00 x 3.50
				35416	58.34 x 3.53	32376	60.00 x 3.00	30892	62.00 x 4.00
				31636	58.42 x 2.62	31993	60.00 x 3.20	34346	62.00 x 4.00
				35417	58.42 x 2.62	30693	60.00 x 3.50	32352	62.00 x 4.50
				31636	58.42 x 2.62	32105	60.00 x 3.50	31090	62.00 x 5.00
				30691	58.50 x 3.50	35426	60.00 x 3.70	33250	62.00 x 5.00
				32303	58.50 x 3.65	30891	60.00 x 4.00	33251	62.00 x 5.00
				31990	58.50 x 5.50	30891	60.00 x 4.00	33145	62.00 x 5.50
				31228	58.50 x 5.50	35427	60.00 x 4.50	33934	62.00 x 6.00
				34319	58.50 x 6.35	31089	60.00 x 5.00	34103	62.00 x 7.00
				34319	58.50 x 6.35	33225	60.00 x 5.00	33006	62.00 x 8.00
				35418	58.70 x 3.00	32209	60.00 x 5.20	35441	62.00 x 9.50
				30770	58.74 x 3.53	32957	60.00 x 5.30	34544	62.00 x 10.00





# Anéis



INCOVE VEDAÇÕES LTDA.

Cód.	Di x Esp.	Cód.	Di x Esp.	Cód.	Di x Esp.	Cód.	Di x Esp.	Cód.	Di x Esp.
31520	62.00 x 10.40	31996	64.00 x 2.60	31419	65.00 x 7.00	33866	67.00 x 5.50	36861	69.50 x 3.00
31147	62.20 x 5.25	30300	64.00 x 2.60	36842	65.00 x 7.50	35473	67.00 x 10.00	35489	69.50 x 4.80
35442	62.30 x 3.60	30449	64.00 x 3.00	32409	65.00 x 8.00	33818	67.10 x 3.60	31305	69.50 x 6.00
32943	62.30 x 4.76	33082	64.00 x 3.00	35461	65.09 x 1.59	33818	67.10 x 3.60	33253	69.50 x 8.00
32362	62.40 x 5.70	30587	64.00 x 3.20	35462	65.09 x 5.16	32217	67.20 x 5.70	31643	69.52 x 2.62
32633	62.50 x 3.00	30587	64.00 x 3.20	33085	65.20 x 5.20	30893	67.50 x 4.00	35489	69.52 x 2.62
33368	62.50 x 5.10	33768	64.00 x 3.50	33085	65.20 x 5.20	33702	67.50 x 4.00	31643	69.52 x 2.62
35443	62.70 x 8.30	33768	64.00 x 3.50	32824	65.50 x 1.50	35474	67.60 x 1.20	31590	69.57 x 1.78
30790	62.80 x 3.60	36398	64.00 x 4.00	36447	65.50 x 3.00	35475	67.80 x 7.00	34052	69.57 x 1.78
31756	62.87 x 5.33	36398	64.00 x 4.00	33404	65.50 x 3.20	31642	67.95 x 2.62	31590	69.57 x 1.78
33011	62.87 x 5.33	31091	64.00 x 5.00	35463	65.50 x 3.50	35476	67.95 x 2.62	33174	69.60 x 3.60
34629	62.87 x 5.33	35453	64.00 x 5.80	33856	65.60 x 0.00	31642	67.95 x 2.62	33200	69.60 x 6.30
35444	62.87 x 5.33	35454	64.00 x 7.00	33856	65.60 x 2.40	35477	68.00 x 1.50	31491	69.70 x 8.40
31756	62.87 x 5.33	31451	64.00 x 7.30	33583	66.00 x 2.00	33854	68.00 x 2.00	35490	69.85 x 3.18
31756	62.90 x 5.33	31253	64.20 x 5.70	33583	66.00 x 2.00		68.00 x 2.50	35491	69.85 x 3.53
35445	63.00 x 2.00	32053	64.20 x 5.70	33583	66.00 x 2.00	36392	68.00 x 2.50	33805	69.85 x 5.33
35445	63.00 x 2.00	31302	64.20 x 6.00	33583	66.00 x 2.00	35478	68.00 x 2.60	35492	69.85 x 5.70
35446	63.00 x 2.50	36399	64.30 x 3.30	30178	66.00 x 2.20	35479	68.00 x 3.00	35493	69.85 x 6.35
35446	63.00 x 2.50	35455	64.30 x 6.50	35464	66.00 x 2.60	32264	68.00 x 3.17	35494	69.85 x 8.33
35446	63.00 x 2.50	35456	64.30 x 10.00	30450	66.00 x 3.00	30756	68.00 x 3.50	35495	69.85 x 9.53
30448	63.00 x 3.00	33889	64.40 x 3.10	30450	66.00 x 3.00	32406	68.00 x 4.00	31364	69.95 x 6.35
30448	63.00 x 3.00	33889	64.40 x 3.10	30450	66.00 x 3.00	32406	68.00 x 4.00	36386	70.00 x 1.30
30446	63.00 x 3.60	36938	64.40 x 5.33	30695	66.00 x 3.50	31013	68.00 x 4.70		70.00 x 1.80
30446	63.00 x 3.60	36938	64.40 x 5.33	30695	66.00 x 3.50	34580	68.00 x 5.00	30167	70.00 x 2.00
30810	63.00 x 3.70	31997	64.68 x 7.35	32223	66.00 x 4.00	34580	68.00 x 5.00	34558	70.00 x 2.00
35447	63.00 x 4.00	35457	64.69 x 7.35	35465	66.00 x 5.00	33278	68.00 x 5.00	33324	70.00 x 2.20
33078	63.00 x 4.30	35458	64.77 x 2.40	31154	66.00 x 5.30	32056	68.00 x 5.25	30282	70.00 x 2.50
34769	63.00 x 4.30	32285	64.77 x 2.61	33797	66.00 x 5.30	32703	68.00 x 5.50	32711	70.00 x 2.50
33108	63.00 x 4.50	31640	64.77 x 2.62	31232	66.00 x 5.50	33626	68.00 x 6.00	34662	70.00 x 2.50
32048	63.00 x 5.00	35459	64.77 x 2.62	34117	66.00 x 6.00	33626	68.00 x 6.00	32000	70.00 x 3.00
32090	63.00 x 6.50	31640	64.77 x 2.62	31420	66.00 x 7.00	32111	68.00 x 7.00	32000	70.00 x 3.00
32100	63.00 x 7.00	31303	64.80 x 6.00	31497	66.00 x 9.00	35480	68.26 x 2.38	32893	70.00 x 3.00
35448	63.00 x 11.00	35460	65.00 x 1.50	35466	66.00 x 16.50	30756	68.26 x 3.53	30588	70.00 x 3.20
31883	63.00 x 12.50	30042	65.00 x 1.60	30696	66.02 x 3.50	35481	68.26 x 6.35	33509	70.00 x 3.20
31694	63.09 x 3.53	30166	65.00 x 2.00	31757	66.04 x 5.33	35482	68.30 x 4.20	30699	70.00 x 3.50
34277	63.09 x 3.53	30166	65.00 x 2.00	33595	66.04 x 5.33	32388	68.50 x 5.70	30699	70.00 x 3.50
31694	63.09 x 3.53	36873	65.00 x 2.50	31170	66.04 x 5.33	33418	68.50 x 8.00	32001	70.00 x 3.50
35449	63.17 x 2.60	36873	65.00 x 2.50	31757	66.04 x 5.33	35483	68.72 x 2.62	30895	70.00 x 4.00
31639	63.17 x 2.62		65.00 x 2.85	35467	66.20 x 5.70	36867	69.00 x 1.50	32484	70.00 x 4.00
31639	63.17 x 2.62	31998	65.00 x 3.00	31695	66.27 x 3.53	36867	69.00 x 1.50		70.00 x 4.20
31588	63.22 x 1.78	31999	65.00 x 3.00	32052	66.27 x 3.53	32759	69.00 x 3.00	35496	70.00 x 4.60
34074	63.22 x 1.78	30694	65.00 x 3.50	31695	66.27 x 3.53	32329	69.00 x 3.00	33069	70.00 x 4.70
31588	63.22 x 1.78	32714	65.00 x 3.50	31641	66.34 x 2.62	32618	69.00 x 3.00	31096	70.00 x 5.00
33017	63.30 x 8.00	30835	65.00 x 4.00	35468	66.34 x 2.62	30607	69.00 x 3.40	32310	70.00 x 5.00
34491	63.50 x 2.00	32594	65.00 x 4.00	31641	66.34 x 2.62	30607	69.00 x 3.40	31096	70.00 x 5.00
35450	63.50 x 3.00	30835	65.00 x 4.00	31589	66.40 x 1.78	34576	69.00 x 3.50	34102	70.00 x 5.50
30460	63.50 x 3.17	30115	65.00 x 5.00	35469	66.40 x 1.78	30697	69.00 x 3.50	35497	70.00 x 6.00
31995	63.50 x 3.20	31092	65.00 x 5.00	31589	66.40 x 1.78	30294	69.00 x 4.00	32002	70.00 x 7.30
36820	63.50 x 3.50	34688	65.00 x 5.00	35470	66.45 x 9.50	35484	69.00 x 4.00	34284	70.00 x 7.50
36820	63.50 x 3.50	31093	65.00 x 5.00	35471	66.45 x 9.50	35485	69.00 x 5.70	30615	70.00 x 10.00
31067	63.50 x 3.96	31231	65.00 x 5.50	30754	66.50 x 2.50	35486	69.00 x 10.00	30615	70.00 x 10.00
35451	63.50 x 4.00	31304	65.00 x 6.00	32608	66.50 x 2.50	31143	69.20 x 5.20	32885	70.50 x 3.00
35452	63.50 x 5.00	31304	65.00 x 6.00	31041	66.50 x 4.90	31254	69.20 x 5.70	34044	70.50 x 4.30
31210	63.50 x 5.40	31304	65.00 x 6.00	35472	66.60 x 7.50	32645	69.20 x 5.70	31097	70.50 x 5.00
36446	64.00 x 2.50	34228	65.00 x 6.30	31095	66.67 x 5.00	32902	69.20 x 5.70	32380	70.50 x 6.00
				33482	67.00 x 1.50	31758	69.22 x 5.33	32713	70.50 x 6.00
				33482	67.00 x 1.50	33288	69.22 x 5.33	32880	70.60 x 12.00
				36923	67.00 x 2.00	31172	69.22 x 5.33	33784	70.63 x 5.00
				36923	67.00 x 2.00	36352	69.22 x 5.33	32909	70.80 x 3.00
				34598	67.00 x 2.50	35487	69.22 x 6.99	32288	71.00 x 1.50
				34342	67.00 x 2.50	34761	69.40 x 3.50	36294	71.00 x 2.00
				34342	67.00 x 2.50	31696	69.40 x 3.50	33867	71.00 x 3.00
				32260	67.00 x 3.00	30698	69.40 x 3.50	32205	71.00 x 4.00
				32260	67.00 x 3.00	31696	69.44 x 3.53	32205	71.00 x 4.00
				33424	67.00 x 3.50	35488	69.44 x 3.53	36296	71.00 x 5.30
				34266	67.00 x 4.20	31696	69.44 x 3.53	31644	71.12 x 2.62
				32056	67.00 x 5.25	31171	69.50 x 2.60	31644	71.12 x 2.62





# Anéis



INCOVE VEDAÇÕES LTDA.

Cód.	Di x Esp.	Cód.	Di x Esp.	Cód.	Di x Esp.	Cód.	Di x Esp.	Cód.	Di x Esp.
31644	71.12 x 2.62	35505	73.00 x 6.50	30897	75.00 x 4.00	33616	77.00 x 3.50	35533	79.77 x 5.33
31644	71.12 x 2.62	33958	73.02 x 4.80	32118	75.00 x 4.20	36395	77.00 x 4.40	31198	79.77 x 5.34
33386	71.30 x 4.60	30757	73.03 x 3.53	34651	75.00 x 5.00	31307	77.00 x 6.00	31156	79.77 x 5.34
32876	71.30 x 6.30	30101	73.50 x 3.00	33817	75.00 x 5.00	35523	77.00 x 6.35	35539	80.00 x 0.00
36483	71.50 x 1.50	35506	73.50 x 4.40	33817	75.00 x 5.00	35524	77.00 x 7.00	36859	80.00 x 1.50
31473	71.50 x 8.00	35507	73.50 x 4.60	33800	75.00 x 5.00	35525	77.00 x 12.00	36859	80.00 x 1.50
35498	71.60 x 5.20	35508	73.50 x 7.20	32725	75.00 x 5.80	32055	77.20 x 5.70	34029	80.00 x 1.80
34087	72.00 x 2.00	33186	73.60 x 4.00	32934	75.00 x 5.80	30899	77.50 x 4.00	32914	80.00 x 2.00
33449	72.00 x 2.00	36900	74.00 x 1.50	32180	75.00 x 6.00	30899	77.50 x 4.00	32914	80.00 x 2.00
30283	72.00 x 2.50	30093	74.00 x 1.90	35515	75.00 x 6.80	35526	77.70 x 2.20	33029	80.00 x 2.20
35499	72.00 x 3.00	36865	74.00 x 2.00	33670	75.00 x 7.00	36409	78.00 x 1.50	33029	80.00 x 2.20
30660	72.00 x 3.20	36865	74.00 x 2.00	34190	75.00 x 8.00	36409	78.00 x 1.50	33657	80.00 x 2.50
33227	72.00 x 3.20	30179	74.00 x 2.20	35516	75.50 x 3.10	32421	78.00 x 2.00	35534	80.00 x 2.50
35500	72.00 x 3.20	30451	74.00 x 3.00	33038	75.50 x 3.20	32421	78.00 x 2.00	30454	80.00 x 3.00
30701	72.00 x 3.50	30451	74.00 x 3.00	33117	75.50 x 3.50	35527	78.00 x 2.00	34708	80.00 x 3.00
32565	72.00 x 3.50	32896	74.00 x 3.20	32992	75.50 x 3.50	30284	78.00 x 2.50	30454	80.00 x 3.00
30700	72.00 x 3.50	33669	74.00 x 3.50	33117	75.50 x 3.50	30284	78.00 x 2.50	32319	80.00 x 3.20
32109	72.00 x 3.50	33669	74.00 x 3.50	33117	75.50 x 3.50	33357	78.00 x 3.00	36457	80.00 x 3.50
30896	72.00 x 4.00	33669	74.00 x 3.50	35517	75.50 x 9.50	33357	78.00 x 3.00	32859	80.00 x 3.80
30896	72.00 x 4.00	33140	74.00 x 4.50	31760	75.56 x 5.33	32716	78.00 x 3.50	30900	80.00 x 4.00
31098	72.00 x 5.00	34681	74.00 x 4.50	33314	75.56 x 5.33	32745	78.00 x 3.50	32471	80.00 x 4.00
33205	72.00 x 5.00	35509	74.00 x 5.00	31760	75.57 x 5.33	32206	78.00 x 4.00	32151	80.00 x 5.00
30381	72.00 x 5.50	35510	74.00 x 6.00	35518	75.57 x 5.33	32206	78.00 x 4.00	32323	80.00 x 5.00
30381	72.00 x 5.50	32682	74.00 x 6.50	36353	75.57 x 5.33	31102	78.00 x 5.00	32106	80.00 x 5.00
35501	72.00 x 7.00	31421	74.00 x 7.00	31698	75.79 x 3.53	32800	78.00 x 5.00	33598	80.00 x 5.25
33330	72.00 x 7.80	31498	74.00 x 9.00	34279	75.79 x 3.53	34290	78.00 x 5.50	33598	80.00 x 5.25
35502	72.00 x 12.00	32797	74.00 x 10.00	31698	75.79 x 3.53	31308	78.00 x 6.00	35535	80.00 x 5.50
35503	72.23 x 7.94	32710	74.00 x 10.00	31646	75.87 x 2.62	31422	78.00 x 7.00	31309	80.00 x 6.00
31759	72.39 x 5.33	35511	74.00 x 11.00	34801	75.87 x 2.62	31422	78.00 x 7.00	33191	80.00 x 6.00
31197	72.39 x 5.33	35512	74.00 x 16.00	34555	75.87 x 2.62	35528	78.40 x 5.00	32214	80.00 x 7.00
31759	72.39 x 5.33	34591	74.20 x 3.00	31646	75.87 x 2.62	30083	78.50 x 1.50	32214	80.00 x 7.00
31645	72.60 x 2.60	34591	74.20 x 3.00	31592	75.92 x 1.78	33419	78.50 x 8.00	35536	80.00 x 8.00
31697	72.62 x 3.53	31526	74.20 x 5.70	32061	75.92 x 1.78	32571	78.60 x 3.20	35537	80.00 x 10.00
32735	72.62 x 3.53	31255	74.20 x 5.70	31592	75.92 x 1.78	31761	78.74 x 5.33	35538	80.00 x 12.00
32062	72.62 x 3.53	33428	74.40 x 3.10	36881	76.00 x 1.50	31761	78.74 x 5.33	35540	80.50 x 2.20
31697	72.62 x 3.53	35513	74.40 x 7.00	36881	76.00 x 1.50	31761	78.74 x 5.33	35541	80.50 x 5.00
31645	72.69 x 2.62	30452	74.50 x 3.00	34527	76.00 x 2.00	31699	78.93 x 3.53	31499	80.80 x 9.00
35504	72.69 x 2.62	30452	74.50 x 3.00	34257	76.00 x 2.00	31699	78.97 x 3.53	35542	80.96 x 6.35
31645	72.69 x 2.62	33241	74.50 x 3.80	32004	76.00 x 2.50	31699	78.97 x 3.53	33945	81.00 x 2.40
31591	72.75 x 1.78	33231	74.50 x 5.30	32613	76.00 x 2.50	34280	78.97 x 5.33	32926	81.00 x 3.00
32538	72.75 x 1.78	31508	74.50 x 9.50	30335	76.00 x 2.80	36906	79.00 x 2.00	32926	81.00 x 3.00
31591	72.75 x 1.78	32873	74.60 x 6.00	36449	76.00 x 3.00	36906	79.00 x 2.00	35543	81.00 x 3.80
30827	72.80 x 3.80	30776	74.61 x 3.57	36449	76.00 x 3.00	_____	79.00 x 2.30	35544	81.00 x 4.00
33723	73.00 x 1.80	32183	74.61 x 3.57	32688	76.00 x 3.17	30703	79.00 x 3.50	34076	81.00 x 4.60
34225	73.00 x 3.00	34645	75.00 x 0.00	32688	76.00 x 3.17	30703	79.00 x 3.50	32795	81.00 x 5.00
34225	73.00 x 3.00	32499	75.00 x 2.00	34186	76.00 x 4.00	35529	79.00 x 4.00	32795	81.00 x 5.00
30702	73.00 x 3.50	32895	75.00 x 2.00	34186	76.00 x 4.00	33769	79.00 x 5.80	31233	81.00 x 5.50
30702	73.00 x 3.50	31963	75.00 x 2.50	32781	76.00 x 4.50	33603	79.00 x 6.00	33689	81.00 x 5.50
33884	73.00 x 4.00	31693	75.00 x 2.50	34770	76.00 x 5.50	32330	79.00 x 6.00	33689	81.00 x 5.50
33884	73.00 x 4.00	31542	75.00 x 3.00	33249	76.00 x 5.50	35530	79.05 x 2.62	34164	81.50 x 2.65
33177	73.00 x 5.00	31542	75.00 x 3.00	31306	76.00 x 6.00	30631	79.20 x 5.70	30600	81.50 x 3.30
32003	73.00 x 5.30	34611	75.00 x 3.00	36943	76.00 x 6.00	34743	79.20 x 5.70	30600	81.50 x 3.30
31155	73.00 x 5.30	36369	75.00 x 3.50	35519	76.00 x 9.00	30631	79.20 x 5.70	30704	81.50 x 3.50
32694	73.00 x 5.50	30897	75.00 x 4.00	35520	76.00 x 9.00	33385	79.30 x 4.60	32487	81.50 x 3.50
32468	73.00 x 6.00	30898	75.00 x 4.00	31892	76.00 x 10.00	32182	79.37 x 3.00	30811	81.50 x 3.70
				31100	76.20 x 5.00	30484	79.37 x 3.00	33254	81.50 x 5.80
				31100	76.20 x 5.00	32182	79.37 x 3.00	35545	81.60 x 3.20
				35521	76.20 x 5.30	32654	79.37 x 6.35	35546	81.70 x 4.40
				34578	76.20 x 6.35	35531	79.38 x 3.18	31762	81.92 x 5.33
				33176	76.20 x 6.35	35532	79.38 x 4.37	31762	81.92 x 5.33
				34477	76.20 x 6.80	32730	79.40 x 3.00	31173	81.92 x 5.33
				33599	76.40 x 4.00	30453	79.40 x 3.00	31762	81.92 x 5.33
				34200	76.70 x 3.30	32730	79.40 x 3.00	35547	81.92 x 6.99
				30168	77.00 x 2.00	32730	79.40 x 3.00	32339	82.00 x 2.00
				35522	77.00 x 2.50	33332	79.50 x 3.50	33067	82.00 x 2.00
				34227	77.00 x 3.00	34715	79.50 x 3.50	30672	82.00 x 2.50
				33616	77.00 x 3.50	34255	79.70 x 5.34	31109	82.00 x 2.50







# Anéis



INCOVE VEDAÇÕES LTDA.

Cód.	Di x Esp.	Cód.	Di x Esp.	Cód.	Di x Esp.	Cód.	Di x Esp.	Cód.	Di x Esp.
32530	82.00 x 2.50	30903	83.50 x 4.00	31104	85.00 x 5.00	31390	87.00 x 6.60	30461	89.50 x 3.00
30456	82.00 x 3.00	35560	83.50 x 10.30	33204	85.00 x 5.00	31392	87.00 x 6.80	30461	89.50 x 3.00
31546	82.00 x 3.00	35561	83.60 x 3.00	33204	85.00 x 5.00	35572	87.30 x 4.80	32395	89.69 x 5.33
30589	82.00 x 3.20	30974	83.60 x 4.20	F14776	85.00 x 5.00	35573	87.30 x 5.50	33164	89.69 x 5.34
30589	82.00 x 3.20	33761	84.00 x 2.60	31245	85.00 x 5.60	30199	87.31 x 2.38	35587	89.70 x 5.30
30901	82.00 x 4.00	36460	84.00 x 3.00	33766	85.00 x 5.60	31026	87.31 x 4.76	32221	90.00 x 2.00
33291	82.00 x 4.00	30590	84.00 x 3.20	36424	85.00 x 5.90	30010	87.50 x 1.25	32221	90.00 x 2.00
33720	82.00 x 5.00	32716	84.00 x 3.50	33808	85.00 x 6.35	36855	87.50 x 2.50	32637	90.00 x 2.50
32335	82.00 x 5.50	34682	84.00 x 3.50	33808	85.00 x 6.35	35574	87.50 x 3.20	30463	90.00 x 3.00
31120	82.00 x 6.00	33170	84.00 x 4.00	31423	85.00 x 7.00	32248	87.60 x 3.00	30463	90.00 x 3.00
31120	82.00 x 6.00	32372	84.00 x 4.60	32739	85.00 x 7.00	35575	87.67 x 2.62	30463	90.00 x 3.00
33326	82.00 x 6.00	32213	84.00 x 5.00	35565	85.00 x 7.50	36884	88.00 x 1.50	33154	90.00 x 3.17
	82.00 x 7.00	35564	84.00 x 5.50	35566	85.00 x 11.00	36884	88.00 x 1.50	32590	90.00 x 3.50
35548	82.00 x 7.50	31310	84.00 x 6.00	31763	85.09 x 5.33	34376	88.00 x 1.60	32505	90.00 x 3.50
34297	82.00 x 9.00	31310	84.00 x 6.00	31175	85.09 x 5.33	33633	88.00 x 2.00	32490	90.00 x 3.50
34297	82.00 x 9.00	33016	84.00 x 6.70	32756	85.09 x 5.33	34659	88.00 x 2.50	32907	90.00 x 3.70
36370	82.00 x 10.00	34174	84.00 x 9.00	31176	85.09 x 5.33	34659	88.00 x 2.50	30906	90.00 x 4.00
31700	82.14 x 3.53	35562	84.00 x 18.00	34583	85.09 x 5.33	32552	88.00 x 3.00	32127	90.00 x 4.00
31700	82.14 x 3.53		84.10 x 2.40	31763	85.09 x 5.33	32552	88.00 x 3.00	32485	90.00 x 4.00
32094	82.14 x 3.53	35563	84.14 x 9.53	31701	85.32 x 3.53	36297	88.00 x 3.50	35588	90.00 x 4.50
36348	82.14 x 3.53	33161	84.40 x 3.10	34278	85.32 x 3.53	34018	88.00 x 3.70	30749	90.00 x 5.00
31647	82.22 x 2.62	33159	84.40 x 3.10	34278	85.32 x 3.53	30905	88.00 x 4.00	31106	90.00 x 5.00
35549	82.22 x 2.62	35565	84.40 x 3.50	31701	85.32 x 3.53	33018	88.00 x 4.00	36888	90.00 x 5.50
31647	82.22 x 2.62	30458	84.50 x 3.00	32199	85.34 x 1.78	35576	88.00 x 8.20	36888	90.00 x 5.50
31593	82.27 x 1.78	30458	84.50 x 3.00	32626	85.40 x 3.00	35577	88.00 x 12.00	31367	90.00 x 6.35
35550	82.27 x 1.78	32643	84.50 x 3.00	35567	85.50 x 2.20	35578	88.00 x 13.50	35589	90.00 x 6.50
31593	82.27 x 1.78	30465	84.50 x 3.00	32579	85.70 x 6.00	31157	88.20 x 5.30	31424	90.00 x 7.00
35551	82.50 x 2.00	32679	84.50 x 3.70	32579	85.70 x 6.00	31157	88.20 x 5.30	33957	90.00 x 12.50
35552	82.50 x 2.80	32690	84.50 x 5.00	35568	85.73 x 2.78	31157	88.20 x 5.30	34329	90.00 x 14.00
33819	82.50 x 4.76	33135	84.50 x 5.70	35569	85.73 x 4.76	31764	88.20 x 5.30	32870	90.10 x 5.80
34709	82.50 x 4.76	33135	84.50 x 5.70	34068	85.75 x 7.50	31257	88.20 x 5.60	32881	90.20 x 14.00
35553	82.50 x 8.00	33376	84.60 x 2.70	36866	86.00 x 2.00	32148	88.20 x 6.00	36892	90.30 x 2.62
32350	82.50 x 10.50	34657	84.60 x 2.70	36866	86.00 x 2.00	31764	88.27 x 5.33	33464	90.40 x 3.30
35554	82.55 x 3.18	35563	84.60 x 3.00	36854	86.00 x 2.20	31177	88.27 x 5.33	35590	90.49 x 1.85
35555	82.55 x 4.76	32855	84.70 x 3.50	34424	86.00 x 2.50	31702	88.49 x 3.53	32641	91.00 x 3.17
35556	82.55 x 12.70	32413	84.80 x 2.20	34424	86.00 x 2.50	35579	88.49 x 3.53	35591	91.00 x 4.00
31530	82.55 x 14.29	35564	84.93 x 2.38	32721	86.00 x 3.00	36349	88.49 x 3.53	32073	91.00 x 4.50
36837	83.00 x 1.50	33719	85.00 x 1.80	32721	86.00 x 3.00	32661	88.49 x 4.01	33331	91.00 x 4.80
36948	83.00 x 2.00	32686	85.00 x 2.00	33403	86.00 x 3.20	33569	88.50 x 2.40	35592	91.00 x 5.00
36897	83.00 x 2.50	32686	85.00 x 2.00	36422	86.00 x 3.60	34568	88.50 x 3.50	32529	91.00 x 5.50
36897	83.00 x 2.50	34672	85.00 x 2.50	36469	86.00 x 4.00	32133	88.50 x 3.50	32115	91.00 x 5.50
33780	83.00 x 3.00	34672	85.00 x 2.50	36469	86.00 x 4.00	31702	88.50 x 3.50	31550	91.00 x 9.52
33780	83.00 x 3.00	30285	85.00 x 2.50	32921	86.00 x 4.30	35580	88.50 x 6.00	35593	91.28 x 4.76
30705	83.00 x 3.50	34768	85.00 x 3.00	36481	86.00 x 4.50	31552	88.50 x 6.20	35594	91.30 x 6.00
33463	83.00 x 3.50	34768	85.00 x 3.00	36481	86.00 x 4.50	35581	88.50 x 10.60	31765	91.44 x 5.33
35557	83.00 x 3.60	33617	85.00 x 3.20	34288	86.00 x 5.00	31648	88.57 x 2.62	35595	91.44 x 5.33
30812	83.00 x 3.70	30706	85.00 x 3.50	30902	86.00 x 5.10	35582	88.57 x 2.62	31765	91.44 x 5.33
35558	83.00 x 4.00	30706	85.00 x 3.50	31140	86.00 x 5.10	31648	88.57 x 2.62	34055	91.50 x 2.00
31103	83.00 x 5.00	30813	85.00 x 3.70	36423	86.00 x 5.70	31594	88.62 x 1.78	35596	91.50 x 3.00
32780	83.00 x 5.30	30904	85.00 x 4.00	34509	86.00 x 6.00	35583	88.62 x 1.78	35597	91.50 x 3.00
36878	83.00 x 5.50	30904	85.00 x 4.00	31366	86.00 x 6.35	31594	88.62 x 1.78	33549	91.60 x 2.70
36878	83.00 x 5.50	30904	85.00 x 4.20	34246	86.00 x 8.00	33144	88.90 x 3.10	33549	91.60 x 2.70
35559	83.00 x 6.50	34516	85.00 x 4.20	35570	86.00 x 9.30	35584	88.90 x 4.30	31703	91.67 x 3.53
34716	83.00 x 9.50	35569	85.00 x 4.50	33084	86.40 x 3.70	34161	88.90 x 4.76	32138	91.67 x 3.53
36316	83.50 x 3.50	35569	85.00 x 4.50	32255	86.50 x 3.50	31105	88.90 x 5.00	31703	91.67 x 3.53
				35571	86.50 x 5.30	35585	88.90 x 6.35	31703	91.67 x 3.53
				32664	86.80 x 3.53	32683	88.90 x 9.50	33125	91.67 x 5.33
				30459	87.00 x 3.00	32467	89.00 x 2.50	32294	91.67 x 5.33
				30459	87.00 x 3.00	32587	89.00 x 2.50	32294	91.67 x 5.33
				32046	87.00 x 3.50	32844	89.00 x 3.00	35597	91.80 x 5.00
								35598	91.80 x 11.00
				32046	87.00 x 3.50	34653	89.00 x 3.00	36845	92.00 x 1.50
				30992	87.00 x 4.50	31929	89.00 x 4.00	36845	92.00 x 1.50
				33852	87.00 x 5.00	31929	89.00 x 4.00	32331	92.00 x 1.80
				32719	87.00 x 5.70	31311	89.00 x 6.00	35599	92.00 x 2.50
				32719	87.00 x 5.70	31311	89.00 x 6.00	30464	92.00 x 3.00
				32405	87.00 x 6.00	33877	89.00 x 10.00	30457	92.00 x 3.00
				30460	87.00 x 6.60	35586	89.20 x 5.70	30464	92.00 x 3.00







# Anéis



INCOVE VEDAÇÕES LTDA.

Cód.	Di	x	Esp.	Cód.	Di	x	Esp.	Cód.	Di	x	Esp.	Cód.	Di	x	Esp.
34704	92.00	x	3.00	31474	94.00	x	8.00	35615	95.20	x	3.80	35628	98.40	x	3.00
32689	92.00	x	3.50	35609	94.00	x	9.50	31027	95.25	x	4.76	35629	98.40	x	4.70
32689	92.00	x	3.50	32131	94.30	x	5.70	31027	95.25	x	4.76	30936	98.42	x	3.00
30908	92.00	x	4.00	34307	94.37	x	2.54	31467	95.25	x	7.94	33454	98.42	x	4.70
30907	92.00	x	4.00	30458	94.50	x	3.00	35616	95.30	x	3.20	35630	98.43	x	3.97
30908	92.00	x	4.00	30458	94.50	x	3.00	33744	95.50	x	3.00	33021	98.60	x	5.00
30993	92.00	x	4.50	34127	94.50	x	5.50	33744	95.50	x	3.00	35631	98.80	x	19.00
34115	92.00	x	4.70	31766	94.62	x	5.33	35617	96.00	x	2.00	30759	98.84	x	3.53
31107	92.00	x	5.00	33173	94.62	x	5.33	36885	96.00	x	2.50	33533	98.84	x	3.53
34401	92.00	x	5.70	32008	94.62	x	5.33	36885	96.00	x	2.50	31010	98.90	x	4.60
34202	92.00	x	6.35	31766	94.62	x	5.33	30467	96.00	x	3.00	36405	99.00	x	3.00
34202	92.00	x	6.35	31766	94.62	x	5.33	30467	96.00	x	3.00	30995	99.00	x	4.50
34543	92.00	x	7.00	35610	94.62	x	6.99	30467	96.00	x	3.00	33285	99.00	x	5.00
31500	92.00	x	9.00	35611	94.80	x	3.80	30591	96.00	x	3.20	34254	99.20	x	5.70
30508	92.07	x	3.10	36894	94.84	x	3.53	35618	96.00	x	5.40	30125	99.20	x	5.70
35600	92.08	x	3.18	31704	94.84	x	3.53	35619	96.00	x	6.00	33220	99.40	x	3.10
35601	92.08	x	4.37	30758	94.84	x	3.53	34450	96.30	x	3.60	33943	99.50	x	3.00
33741	92.34	x	3.33	31704	94.84	x	3.53	35620	96.40	x	4.00	33943	99.50	x	3.00
33187	92.40	x	5.30	31649	94.92	x	2.62	35621	96.50	x	2.62	35632	99.80	x	3.50
33655	92.50	x	5.30	35612	94.92	x	2.62	34725	97.00	x	3.00	36365	100.00	x	1.50
33480	92.50	x	5.80	36343	94.92	x	2.62	34725	97.00	x	3.00	36365	100.00	x	1.50
31246	92.80	x	5.50	31595	94.97	x	1.78	30602	97.00	x	3.30	30169	100.00	x	2.00
31531	92.80	x	14.60	32539	94.97	x	1.78	30602	97.00	x	3.30	30169	100.00	x	2.00
35602	92.87	x	8.39	36336	94.97	x	1.78	33465	97.00	x	3.30	30169	100.00	x	2.00
32973	93.00	x	1.50	33610	95.00	x	1.50	30710	97.00	x	3.50	33413	100.00	x	2.50
36381	93.00	x	2.00	33615	95.00	x	2.00	32401	97.00	x	3.50	33413	100.00	x	2.50
32528	93.00	x	2.50	33615	95.00	x	2.00	30910	97.00	x	4.00	30469	100.00	x	3.00
33955	93.00	x	3.00	31965	95.00	x	2.50	36425	97.00	x	4.20	30469	100.00	x	3.00
32259	93.00	x	3.00	31965	95.00	x	2.50	34533	97.00	x	5.00	34636	100.00	x	3.00
30601	93.00	x	3.30	34304	95.00	x	2.62	34533	97.00	x	5.00	30517	100.00	x	3.17
32673	93.00	x	3.50	30466	95.00	x	3.00	32082	97.00	x	5.70	35633	100.00	x	3.20
30707	93.00	x	3.50	30466	95.00	x	3.00	32082	97.00	x	5.70	30712	100.00	x	3.50
35603	93.00	x	4.00	30466	95.00	x	3.00	31385	97.00	x	6.50	34670	100.00	x	3.50
35604	93.00	x	5.00	30466	95.00	x	3.00	32201	97.00	x	6.50	36426	100.00	x	3.80
31888	93.00	x	5.60	30709	95.00	x	3.50	34793	97.00	x	9.00	34690	100.00	x	4.00
31247	93.00	x	5.60	31538	95.00	x	4.00	35622	97.20	x	5.70	30911	100.00	x	4.00
32263	93.00	x	6.00	31538	95.00	x	4.00	34033	97.50	x	2.50	34690	100.00	x	4.00
34717	93.00	x	9.50	31538	95.00	x	4.00	35623	97.50	x	5.00	33087	100.00	x	4.50
35605	93.00	x	20.00	31538	95.00	x	4.00	30711	97.60	x	3.50	33087	100.00	x	4.50
35606	93.26	x	3.53	30994	95.00	x	4.50	32712	97.60	x	3.50	32188	100.00	x	5.00
33758	93.40	x	4.00	31110	95.00	x	5.00	31767	97.79	x	5.33	32188	100.00	x	5.00
33758	93.40	x	4.00	32972	95.00	x	5.00	35624	97.79	x	5.33	32188	100.00	x	5.00
34165	93.50	x	2.65	31110	95.00	x	5.00	31767	97.79	x	5.33	31234	100.00	x	5.50
33063	93.50	x	4.50	31110	95.00	x	5.00	35625	97.79	x	9.53	33534	100.00	x	6.00
33396	93.60	x	3.20	33156	95.00	x	5.60	34041	97.80	x	5.30	33833	100.00	x	6.00
35607	93.60	x	3.53	33155	95.00	x	5.60	34041	97.80	x	5.30	35635	100.00	x	6.50
30336	93.70	x	2.80	31312	95.00	x	6.00	34039	97.82	x	1.78	35636	100.00	x	6.50
32726	94.00	x	2.50	31313	95.00	x	6.00	34494	98.00	x	1.55	35637	100.00	x	6.80
33629	94.00	x	3.00	35613	95.00	x	7.00	36396	98.00	x	2.00	31425	100.00	x	7.00
35608	94.00	x	3.00	33171	95.00	x	7.50	36482	98.00	x	2.50	33459	100.00	x	7.00
30708	94.00	x	3.50	33172	95.00	x	7.50	36482	98.00	x	2.50	31426	100.00	x	7.00
30708	94.00	x	3.50	33172	95.00	x	7.50	36494	98.00	x	2.70	31476	100.00	x	8.00
31108	94.00	x	5.00	30909	95.00	x	8.00	30468	98.00	x	3.00	35638	100.00	x	9.00
31384	94.00	x	6.50	31475	95.00	x	8.00	32384	98.00	x	3.00	36877	100.00	x	10.00
31452	94.00	x	7.30	35614	95.00	x	22.00	34701	98.00	x	3.00	35639	100.00	x	12.00
								36371	98.00	x	3.50	35640	100.00	x	12.70
								36371	98.00	x	3.50	35641	100.00	x	15.00
								33650	98.00	x	4.00	33175	100.30	x	4.80
								33650	98.00	x	4.00	32835	100.50	x	2.50
								32677	98.00	x	5.00	31158	100.50	x	5.30
								34502	98.00	x	6.00	32867	100.80	x	4.50
								35626	98.00	x	7.00	32532	100.90	x	5.30
								34639	98.00	x	12.00	32532	100.90	x	5.30
								31705	98.02	x	3.53	31159	100.90	x	5.30
								35627	98.02	x	3.53	32532	100.90	x	5.30
								36350	98.02	x	3.53	31768	100.97	x	5.33
								33504	98.40	x	2.50	35642	100.97	x	5.33
												31768	100.97	x	5.33
												35658	103.00	x	8.00
												36322	101.00	x	3.00
												36322	101.00	x	3.00
												32262	101.00	x	4.50
												31144	101.00	x	5.20
												31144	101.00	x	5.20
												34049	101.00	x	5.70
												31314	101.00	x	6.00
												31706	101.19	x	3.53
												30760	101.19	x	3.53
												32295	101.19	x	3.53
												31706	101.19	x	3.53
												35643	101.20	x	3.18
												31650	101.27	x	2.62
												35644	101.27	x	2.62
												31650	101.27	x	2.62
												31596	101.32	x	1.78
												35645	101.32	x	1.78
												31596	101.32	x	1.78
												34060	101.60	x	1.98
												34640	101.60	x	1.98
												30173	101.60	x	2.00
												33989	101.60	x	3.17
												33989	101.60	x	3.17
												35646	101.60	x	3.97
												30912	101.60	x	4.00
												35647	101.60	x	4.37
												35648	101.60	x	4.76
												35649	101.60	x	6.00
												35650	101.60	x	7.94
												31509	101.60	x	9.50
												35652	101.60	x	9.53
												32850	101.70	x	3.00



# Anéis



INCOVE VEDAÇÕES LTDA.

Cód.	Di	x	Esp.	Cód.	Di	x	Esp.	Cód.	Di	x	Esp.	Cód.	Di	x	Esp.	Cód.	Di	x	Esp.
35659	103.00	x	9.00	30914	105.00	x	4.00	31708	107.54	x	3.53	31113	110.00	x	5.00	34602	113.00	x	7.00
32886	103.00	x	10.00	34758	105.00	x	4.40	31708	107.54	x	3.53	31113	110.00	x	5.00	35699	113.00	x	7.80
36918	103.10	x	7.10	34757	105.00	x	4.50	31651	107.62	x	2.62	31160	110.00	x	5.30	35700	113.00	x	9.50
33306	103.50	x	2.00	32190	105.00	x	4.70	35672	107.62	x	2.62	33030	110.00	x	5.33	32610	113.00	x	9.90
33306	103.50	x	2.00	32190	105.00	x	4.70	31651	107.62	x	2.62	31238	110.00	x	5.50	32284	113.00	x	10.00
32216	103.50	x	4.30	30713	105.00	x	5.00	35673	107.65	x	1.78	35687	110.00	x	6.00	32578	113.00	x	10.30
31316	103.50	x	6.00	34219	105.00	x	5.00	31597	107.67	x	1.78	31386	110.00	x	6.50	35701	113.00	x	12.00
31258	103.60	x	5.70	30713	105.00	x	5.00	32537	107.67	x	1.78	35689	110.00	x	7.00	33068	113.50	x	4.60
35659	103.65	x	6.35	30713	105.00	x	5.00	31597	107.67	x	1.78	33937	110.00	x	8.00	31286	113.50	x	5.95
35660	103.70	x	10.50	33638	105.00	x	5.50	35674	107.90	x	4.20	33937	110.00	x	8.00	30385	113.59	x	3.53
34175	104.00	x	1.80	33826	105.00	x	6.00	31521	107.90	x	10.40	32901	110.00	x	8.50	32858	113.60	x	3.70
33873	104.00	x	2.50	31502	105.00	x	9.00	35675	107.95	x	4.76	33925	110.00	x	9.00	31772	113.67	x	5.33
32307	104.00	x	2.80	31236	105.50	x	5.50	35676	107.95	x	6.35	35690	110.33	x	4.37	35702	113.67	x	5.33
35661	104.00	x	3.00	32698	106.00	x	1.50	35677	107.95	x	9.53	33436	110.33	x	4.40	31772	113.67	x	5.33
35661	104.00	x	3.00	31076	106.00	x	2.00	34256	108.00	x	2.00	31771	110.49	x	5.33	31819	113.67	x	6.99
35661	104.00	x	3.00	31076	106.00	x	2.00	34678	108.00	x	2.80	32567	110.49	x	5.33	35703	113.67	x	6.99
30603	104.00	x	3.30	33908	106.00	x	2.50	30473	108.00	x	3.00	31771	110.49	x	5.33	31819	113.67	x	6.99
33054	104.00	x	4.00	36477	106.00	x	3.00	30473	108.00	x	3.00	31771	110.49	x	5.33	31709	113.89	x	3.53
33054	104.00	x	4.00	33658	106.00	x	3.20	32132	108.00	x	3.00	31771	110.49	x	5.33	31709	113.89	x	3.53
34352	104.00	x	5.00	33199	106.00	x	3.50	32635	108.00	x	3.20	34364	110.70	x	7.90	31709	113.89	x	3.53
34741	104.00	x	5.00	33199	106.00	x	3.50	32635	108.00	x	3.20	30771	110.72	x	3.53	31709	113.89	x	3.53
35662	104.00	x	5.60	34159	106.00	x	4.00	30916	108.00	x	4.00	31880	110.72	x	3.53	35704	113.90	x	6.35
33956	104.00	x	7.00	34159	106.00	x	4.00	30916	108.00	x	4.00	30771	110.72	x	3.53	31652	113.97	x	2.62
34061	104.00	x	8.00	33473	106.00	x	4.20	32755	108.00	x	4.50	30761	110.72	x	3.53	35705	113.97	x	2.62
30345	104.00	x	9.40	33821	106.00	x	4.50	31478	108.00	x	8.00	31880	110.72	x	3.53	31652	113.97	x	2.62
36857	104.10	x	5.70	31112	106.00	x	5.00	33261	108.00	x	8.00	32204	110.74	x	1.78	30339	114.00	x	3.00
36911	104.10	x	8.00	31141	106.00	x	5.10	35678	108.00	x	10.30	32864	110.80	x	4.00	30339	114.00	x	3.00
31769	104.14	x	5.33	31317	106.00	x	6.00	35679	108.00	x	12.00	35691	110.85	x	1.78	33451	114.00	x	5.20
31769	104.14	x	5.33	33763	106.00	x	6.00	35680	108.00	x	13.50	30170	111.00	x	2.00	33451	114.00	x	5.20
31769	104.14	x	5.33	34012	106.00	x	6.50	35681	108.50	x	5.00	30717	111.00	x	3.50	33097	114.00	x	6.00
31769	104.14	x	5.33	34002	106.00	x	7.00	35682	108.70	x	3.00	30917	111.00	x	4.00	31459	114.00	x	7.50
32498	104.20	x	5.70	31477	106.00	x	8.00	35683	109.00	x	2.10	30917	111.00	x	4.00	31599	114.02	x	1.78
36858	104.37	x	3.53	35668	106.00	x	16.00	34156	109.00	x	2.50	31015	111.00	x	4.70	31598	114.02	x	1.78
31707	104.37	x	3.53	35669	106.30	x	5.00	31889	109.00	x	3.00	35692	111.00	x	5.10	36337	114.02	x	1.78
31707	104.37	x	3.53	34257	106.50	x	3.00	31889	109.00	x	3.00	33773	111.00	x	5.80	32187	114.20	x	5.70
30032	104.50	x	2.00	35670	106.50	x	4.00	32947	109.00	x	4.40	35693	111.00	x	6.00	35706	114.30	x	3.00
32665	104.50	x	2.62	32219	107.00	x	2.00	34366	109.00	x	5.30	35694	111.00	x	16.00	35707	114.30	x	4.37
32960	104.50	x	2.62	34649	107.00	x	2.00	35684	109.20	x	5.50	35695	111.13	x	4.76	35708	114.30	x	4.40
32890	104.50	x	3.00	30593	107.00	x	3.20	31332	109.20	x	5.70	32393	111.50	x	3.00	31020	114.30	x	4.76
30471	104.50	x	3.00	30715	107.00	x	3.70	31332	109.40	x	5.70	35696	111.50	x	5.50	35709	114.30	x	5.00
30471	104.50	x	3.00	30915	107.00	x	4.00	31318	109.40	x	6.00	34251	111.92	x	2.62	31259	114.30	x	5.70
32890	104.50	x	3.00	34779	107.00	x	4.00	34429	109.50	x	3.00	34142	112.00	x	2.00	32646	114.30	x	5.70
35663	104.50	x	9.80	30996	107.00	x	4.50	34429	109.50	x	3.00	34142	112.00	x	2.00	36827	114.30	x	9.53
35664	104.60	x	5.70	31237	107.00	x	5.50	32298	109.50	x	3.50	33853	112.00	x	3.00	33425	114.40	x	3.10
31014	104.70	x	4.70	31237	107.00	x	5.50	32298	109.50	x	3.50	33853	112.00	x	3.00	30474	114.50	x	3.00
30646	104.77	x	6.35	31429	107.00	x	7.00	35685	109.50	x	5.00	33853	112.00	x	3.00	33864	114.50	x	3.00
35665	104.78	x	6.35	32408	107.00	x	9.00	34366	109.50	x	5.30	30793	112.00	x	3.60	34430	114.50	x	3.00
35666	104.78	x	9.13	34501	107.30	x	2.30	32296	109.50	x	5.50	33488	112.00	x	3.80	35710	114.50	x	4.00
32676	105.00	x	1.50	31770	107.32	x	5.33	32869	109.60	x	4.00	30918	112.00	x	4.00	31239	114.50	x	5.50
35667	105.00	x	1.80	33604	107.32	x	5.33	32861	109.64	x	4.00	30918	112.00	x	4.00	31260	114.50	x	5.70
33753	105.00	x	2.77	31770	107.32	x	5.33	35686	110.00	x	1.50	30999	112.00	x	4.50	36327	115.00	x	1.50
30472	105.00	x	3.00	35671	107.32	x	6.99	36383	110.00	x	1.70	33918	112.00	x	4.50	32343	115.00	x	2.00
30472	105.00	x	3.00	31708	107.54	x	3.53	32220	110.00	x	2.00	30998	112.00	x	4.50	32343	115.00	x	2.00
30592	105.00	x	3.20	31708	107.54	x	3.53	32220	110.00	x	2.00	35697	112.00	x	5.50	36319	115.00	x	2.50
30914	105.00	x	4.00	32009	107.54	x	3.53	34505	110.00	x	2.40	33027	112.00	x	5.60	36319	115.00	x	2.50
								32369	110.00	x	3.00	32971	112.00	x	6.00	35711	115.00	x	3.00
								32369	110.00	x	3.00	32010	112.00	x	6.00	35712	115.00	x	3.00
								32653	110.00	x	3.00	31464	112.00	x	7.90	30718	115.00	x	3.50
								34782	110.00	x	3.00	31145	112.30	x	5.20	32690	115.00	x	4.00
								30716	110.00	x	3.50	31446	112.70	x	7.10	32364	115.00	x	4.50
								32905	110.00	x	4.00	30088	113.00	x	1.80	31152	115.00	x	5.00
								32905	110.00	x	4.00	34511	113.00	x	3.00	34752	115.00	x	5.00
								33592	110.00	x	4.10	32546	113.00	x	3.50	32083	115.00	x	5.30
								33592	110.00	x	4.10	35698	113.00	x	5.00	32083	115.00	x	5.30
								33778	110.00	x	4.10	30859	113.00	x	6.00	31240	115.00	x	5.50
								30997	110.00	x	4.50	33216	113.00	x	7.00	35713	115.00	x	7.00
								30997	110.00	x	4.50	32308	113.00	x	7.00	32879	115.00	x	8.00





# Anéis



INCOVE VEDAÇÕES LTDA.

Cód.	Di	x	Esp.	Cód.	Di	x	Esp.	Cód.	Di	x	Esp.	Cód.	Di	x	Esp.	Cód.	Di	x	Esp.
36827	115.00	x	9.53	30594	118.00	x	3.20	33289	120.02	x	5.33	31566	124.00	x	3.00	35768	126.59	x	3.53
30224	115.00	x	15.00	30921	118.00	x	4.00	31774	120.02	x	5.33	31566	124.00	x	3.00	31713	126.59	x	3.53
35714	115.50	x	2.00	30921	118.00	x	4.00	31774	120.02	x	5.33	33096	124.00	x	4.00	32355	126.59	x	5.95
32340	115.50	x	5.00	32090	118.00	x	4.50	31821	120.02	x	6.99	33096	124.00	x	4.00	32355	126.59	x	5.95
32340	115.50	x	5.00	32107	118.00	x	5.00	31394	120.02	x	6.99	31387	124.00	x	6.50	31654	126.67	x	2.62
35715	115.50	x	6.00	31116	118.00	x	5.00	31394	120.02	x	6.99	32933	124.00	x	7.00	35769	126.67	x	2.62
35716	115.50	x	9.50	31126	118.00	x	5.00	31711	120.24	x	3.53	32727	124.00	x	7.00	31654	126.67	x	2.62
35717	115.50	x	9.50	31161	118.00	x	5.30	31711	120.24	x	3.53	36289	124.00	x	7.50	31600	126.72	x	1.78
33333	115.60	x	5.50	31161	118.00	x	5.30	31653	120.32	x	2.62	33988	124.00	x	8.00	35770	126.72	x	1.78
34112	116.00	x	3.00	35728	118.00	x	7.00	35736	120.32	x	2.62	31528	124.00	x	14.00	36848	127.00	x	2.50
34112	116.00	x	3.00	35729	118.00	x	12.00	31653	120.32	x	2.62	34565	124.30	x	0.00	32996	127.00	x	3.00
30919	116.00	x	4.00	35730	118.30	x	8.50	31599	120.37	x	1.78	30629	124.30	x	5.70	32407	127.00	x	4.00
31319	116.00	x	6.00	32472	119.00	x	3.00	31599	120.37	x	1.78	32196	124.50	x	2.40	32407	127.00	x	4.00
31319	116.00	x	6.00	32472	119.00	x	3.00	35737	120.50	x	7.00	33296	124.50	x	5.70	30977	127.00	x	4.30
31379	116.00	x	6.40	33221	119.00	x	3.50	35738	120.64	x	3.53	31450	124.90	x	7.20	35771	127.00	x	5.00
35718	116.00	x	8.00	33020	119.00	x	4.00	35739	120.65	x	4.37	32397	125.00	x	2.00	34524	127.00	x	5.70
34508	116.00	x	10.00	31000	119.00	x	4.50	35740	120.65	x	4.76	32397	125.00	x	2.00	34669	127.00	x	5.70
34199	116.70	x	4.70	31001	119.00	x	4.50	31199	120.70	x	5.34	35760	125.00	x	2.10	32874	127.00	x	6.00
33004	116.84	x	5.33	35731	119.00	x	5.00	31199	120.70	x	5.34	36408	125.00	x	2.50	31370	127.00	x	6.35
33004	116.84	x	5.33	35732	119.00	x	5.80	35741	121.00	x	2.00	36408	125.00	x	2.50	33301	127.00	x	12.70
31773	116.84	x	5.33	31320	119.00	x	6.00	30475	121.00	x	3.00	30476	125.00	x	3.00	36851	128.00	x	2.50
31820	116.84	x	6.99	36493	119.00	x	7.00	30475	121.00	x	3.00	32642	125.00	x	3.00	36851	128.00	x	2.50
35719	116.84	x	6.99	30462	119.00	x	8.00	32508	121.00	x	4.00	30476	125.00	x	3.00	30477	128.00	x	3.00
32354	116.84	x	7.00	34226	119.00	x	10.00	35742	121.00	x	8.00	36452	125.00	x	3.50	34584	128.00	x	3.00
31428	116.84	x	7.00	34698	119.00	x	10.00	34718	121.00	x	9.50	33857	125.00	x	4.00	30720	128.00	x	3.50
33882	117.00	x	2.50	35733	119.06	x	1.98	34167	121.20	x	2.50	33857	125.00	x	4.00	36368	128.00	x	4.00
33882	117.00	x	2.50	30577	119.20	x	5.70	36400	122.00	x	2.00	31121	125.00	x	5.00	31003	128.00	x	4.50
35720	117.00	x	3.00	34230	119.30	x	5.70	36400	122.00	x	2.00	34556	125.00	x	5.00	33431	128.00	x	5.00
35721	117.00	x	4.00	35734	119.70	x	18.70	36852	122.00	x	3.00	32398	125.00	x	6.00	33431	128.00	x	5.00
31241	117.00	x	5.50	36382	120.00	x	1.00	36852	122.00	x	3.00	32191	125.00	x	6.00	33431	128.00	x	5.00
30743	117.00	x	5.50	33787	120.00	x	1.90	35743	122.00	x	3.50	31321	125.00	x	6.00	31322	128.00	x	6.00
34425	117.00	x	6.00	36847	120.00	x	2.50	30924	122.00	x	4.00	34461	125.00	x	6.80	35772	128.00	x	9.00
34425	117.00	x	6.00	36847	120.00	x	2.50	31118	122.00	x	5.00	34461	125.00	x	6.80	30455	128.20	x	7.00
32011	117.03	x	3.53	34458	120.00	x	2.70	31118	122.00	x	5.00	31429	125.00	x	7.00	30455	128.20	x	7.00
32011	117.03	x	3.53	34458	120.00	x	2.70	36840	122.00	x	6.00	33992	125.00	x	10.00	34141	128.40	x	2.62
36834	117.06	x	3.50	120.00	x	3.00	36840	122.00	x	6.00	35763	125.02	x	7.99	32014	128.50	x	4.00	
30763	117.07	x	3.53	32853	120.00	x	3.00	34362	122.00	x	7.00	33037	125.30	x	2.50	30927	128.50	x	4.00
30763	117.07	x	3.53	32853	120.00	x	3.00	35744	122.00	x	10.00	32497	125.40	x	3.40	35773	128.50	x	16.00
30762	117.07	x	3.53	32012	120.00	x	3.50	31533	122.00	x	18.00	35764	125.41	x	2.38	35774	128.57	x	3.53
32011	117.07	x	3.53	30719	120.00	x	3.50	35745	122.20	x	5.70	35765	125.50	x	3.00	30842	128.59	x	3.97
32011	117.07	x	3.53	30922	120.00	x	4.00	35746	122.40	x	6.30	33077	125.60	x	3.60	35775	128.59	x	5.95
35723	117.07	x	4.40	30922	120.00	x	4.00	34109	123.00	x	2.00	34460	125.60	x	3.60	35776	128.59	x	9.53
35724	117.08	x	3.97	31002	120.00	x	4.50	35747	123.00	x	4.00	34373	126.00	x	1.78	35777	128.60	x	4.50
35725	117.30	x	2.70	33043	120.00	x	4.70	35748	123.00	x	5.00	34648	126.00	x	1.78	35778	129.00	x	3.00
33342	117.40	x	2.90	31117	120.00	x	5.00	35749	123.00	x	10.00	34166	126.00	x	2.60	32464	129.00	x	3.50
30036	117.47	x	1.59	33073	120.00	x	5.00	35750	123.00	x	12.00	34166	126.00	x	2.60	32464	129.00	x	3.50
31029	117.47	x	4.76	31117	120.00	x	5.00	35751	123.03	x	4.76	36473	126.00	x	3.00	32782	129.00	x	4.00
35726	117.48	x	2.15	32373	120.00	x	5.50	31775	123.19	x	5.33	36473	126.00	x	3.00	31017	129.00	x	4.70
34128	117.48	x	6.35	34197	120.00	x	6.00	31179	123.19	x	5.33	34525	126.00	x	3.50	31017	129.00	x	4.70
36898	117.70	x	0.00	33949	120.00	x	6.30	31178	123.19	x	5.33	34525	126.00	x	3.50	31122	129.00	x	5.00
30920	117.80	x	4.00	33949	120.00	x	6.30	31822	123.19	x	6.99	30926	126.00	x	4.00	34303	129.00	x	6.00
36458	118.00	x	2.00	36390	120.00	x	8.00	31776	123.19	x	6.99	30926	126.00	x	4.00	34303	129.00	x	6.00
34022	118.00	x	2.80	35735	120.00	x	20.00	35753	123.19	x	6.99	33099	126.00	x	4.50	31261	129.20	x	5.70
35727	118.00	x	3.00	30923	120.02	x	4.00	31822	123.19	x	6.99	32065	126.00	x	5.50	31261	129.20	x	5.70
30594	118.00	x	3.20	31774	120.02	x	5.33	34635	123.20	x	5.30	31430	126.00	x	7.00	33470	129.40	x	3.10
31712	123.42	x	3.53	31712	123.42	x	3.53	32403	126.00	x	11.90	30015	129.50	x	3.00				
35754	123.42	x	3.53	31712	123.42	x	3.53	31181	126.37	x	5.33	30015	129.50	x	3.00				
35755	123.80	x	3.00	35755	123.80	x	3.00	33313	126.37	x	5.33	30015	129.50	x	3.00				
35756	123.80	x	6.00	35756	123.80	x	6.00	31181	126.37	x	5.33	31004	129.50	x	4.50				
35757	123.80	x	7.60	35757	123.80	x	7.60	31823	126.37	x	6.99	35779	129.54	x	1.65				
31510	123.80	x	9.50	31510	123.80	x	9.50	35766	126.37	x	6.99	35780	129.54	x	1.65				
31368	123.82	x	6.35	31368	123.82	x	6.35	31823	126.37	x	6.99	31183	129.54	x	5.33				
32013	123.82	x	6.35	32013	123.82	x	6.35	32984	126.40	x	6.98	31824	129.54	x	6.99				
35758	123.83	x	3.18	35758	123.83	x	3.18	32984	126.40	x	6.99	35782	129.54	x	6.99				
35759	123.83	x	6.35	35759	123.83	x	6.35	32984	126.40	x	6.99	31824	129.54	x	6.99				
34355	124.00	x	1.50	34355	124.00	x	1.50	35767	126.50	x	4.00	31714	129.77	x	3.53				
								31713	126.59	x	3.53	35783	129.77	x	3.53				





# Anéis



INCOVE VEDAÇÕES LTDA.

Cód.	Di	x	Esp.	Cód.	Di	x	Esp.	Cód.	Di	x	Esp.	Cód.	Di	x	Esp.	Cód.	Di	x	Esp.
31714	129.77	x	3.53	31715	132.94	x	3.53	33754	135.00	x	4.20	31780	139.07	x	5.33	31718	142.47	x	3.53
36899	130.00	x	2.00	31715	132.94	x	3.53	32125	135.00	x	5.00	31827	139.07	x	6.99	36860	143.00	x	2.00
36899	130.00	x	2.00	32245	133.00	x	3.00	33530	135.00	x	5.00	31396	139.07	x	6.99	36860	143.00	x	2.00
30287	130.00	x	2.50	32245	133.00	x	3.00	32125	135.00	x	5.00	34603	139.07	x	6.99	34799	143.00	x	2.50
34570	130.00	x	2.50	30123	133.00	x	3.50	34192	135.00	x	5.50	31827	139.07	x	6.99	34182	143.00	x	3.00
31537	130.00	x	3.00	30930	133.00	x	4.00	34684	135.00	x	5.50	31717	139.29	x	3.53	34182	143.00	x	3.00
30478	130.00	x	3.00	30930	133.00	x	4.00	31285	135.00	x	5.90	31717	139.29	x	3.53	35831	143.00	x	4.80
30479	130.00	x	3.00	36945	133.00	x	6.80	35803	135.00	x	6.00	31717	139.29	x	3.53	32966	143.00	x	5.00
30595	130.00	x	3.20	32536	133.02	x	2.62	32777	135.00	x	6.35	31264	139.30	x	5.70	35832	143.00	x	5.50
30721	130.00	x	3.50	31655	133.02	x	2.62	32777	135.00	x	6.35	31263	139.30	x	5.70	33142	143.00	x	6.40
30721	130.00	x	3.50	31655	133.02	x	2.62	34065	135.00	x	7.50	31656	139.37	x	2.62	35833	144.00	x	3.00
30929	130.00	x	4.00	36344	133.02	x	2.62	35804	135.00	x	8.00	35823	139.37	x	2.62	35833	144.00	x	3.00
30929	130.00	x	4.00	31601	133.07	x	1.78	35805	135.00	x	10.00	31656	139.37	x	2.62	35833	144.00	x	3.00
31930	130.00	x	5.00	35795	133.07	x	1.78	35806	135.00	x	19.00	33870	139.50	x	2.00	33798	144.00	x	4.00
31930	130.00	x	5.00	32559	133.20	x	9.50	34009	135.89	x	5.33	31900	139.50	x	3.00	33798	144.00	x	4.00
31930	130.00	x	5.00	35796	133.30	x	5.00	31184	135.89	x	5.33	33847	139.50	x	3.00	31448	144.06	x	7.14
35781	130.00	x	5.40	35797	133.35	x	6.35	34009	135.89	x	5.33	34308	139.70	x	3.18	31371	144.22	x	6.35
31323	130.00	x	6.00	31519	133.35	x	10.32	34606	135.89	x	5.33	35824	139.70	x	3.97	31243	144.30	x	5.50
31323	130.00	x	6.00	31200	133.40	x	5.34	31826	135.89	x	6.99	31242	139.70	x	5.50	32657	144.30	x	5.70
33486	130.00	x	6.35	32851	133.80	x	3.00	33123	135.89	x	6.99	30481	139.70	x	5.50	32237	144.30	x	5.70
36822	130.00	x	7.50	36413	133.85	x	5.33	31826	135.89	x	6.99	35825	139.70	x	6.00	31265	144.30	x	5.70
35784	130.18	x	4.76	33725	133.90	x	6.70	35807	135.89	x	6.99	34114	139.70	x	6.35	34045	144.46	x	1.85
35785	130.18	x	6.35	35798	134.00	x	2.00	35807	135.89	x	6.99	33870	140.00	x	2.00	35834	144.46	x	6.35
33593	130.18	x	7.00	35799	134.00	x	2.00	35808	136.00	x	2.00	33870	140.00	x	2.00	30483	144.50	x	3.00
34776	130.18	x	7.00	36488	134.00	x	3.00	33641	136.00	x	3.00	32898	140.00	x	3.00	30483	144.50	x	3.00
33435	130.30	x	4.80	34325	134.00	x	3.20	33641	136.00	x	3.00	32898	140.00	x	3.00	35835	144.50	x	5.50
35786	130.50	x	4.50	34439	134.00	x	4.00	33641	136.00	x	3.00	32898	140.00	x	3.00	35836	144.78	x	4.19
33039	130.50	x	5.30	34439	134.00	x	4.00	33336	136.00	x	4.50	33256	140.00	x	3.10	32277	144.86	x	7.14
31710	131.00	x	3.50	31479	134.00	x	8.00	35809	136.00	x	5.00	36291	140.00	x	3.50	36372	145.00	x	2.00
30722	131.00	x	3.50	31897	134.00	x	9.00	31716	136.12	x	3.53	36291	140.00	x	3.50	36836	145.00	x	2.50
34013	131.00	x	4.40	35800	134.20	x	5.70	35810	136.12	x	3.53	30933	140.00	x	4.00	36836	145.00	x	2.50
35787	131.00	x	4.70	31262	134.30	x	5.70	31716	136.12	x	3.53	30933	140.00	x	4.00	33541	145.00	x	3.00
34267	131.00	x	5.00	31262	134.30	x	5.70	33282	136.50	x	4.00	31123	140.00	x	5.00	33541	145.00	x	3.00
32193	131.40	x	1.78	33469	134.40	x	3.10	35811	136.50	x	5.60	33919	140.00	x	5.00	33541	145.00	x	3.00
35788	131.50	x	6.40	31895	134.40	x	7.00	35812	136.53	x	6.35	31124	140.00	x	5.00	30725	145.00	x	3.50
35789	131.60	x	7.50	31895	134.40	x	7.00	34542	136.64	x	7.50	34496	140.00	x	5.70	30725	145.00	x	3.50
32684	131.76	x	5.56	32625	134.50	x	3.00	32839	136.70	x	2.50	34247	140.00	x	6.35	30934	145.00	x	4.00
33479	132.00	x	2.00	34459	134.50	x	3.00	31516	136.70	x	10.00	31480	140.00	x	8.00	30934	145.00	x	4.00
30480	132.00	x	3.00	35801	134.50	x	3.20	35813	137.00	x	3.00	34011	141.00	x	2.60	36919	145.00	x	4.50
30480	132.00	x	3.00	35802	134.60	x	4.20	30829	137.00	x	3.80	34011	141.00	x	2.60	32079	145.00	x	5.00
30828	132.00	x	3.80	32609	134.60	x	5.30	33868	137.00	x	4.00	30796	141.00	x	3.65	32523	145.00	x	5.00
35790	132.00	x	4.00	31928	134.60	x	5.30	35814	137.00	x	4.70	32734	141.00	x	3.65	32289	145.00	x	5.30
32084	132.00	x	5.00	33426	134.60	x	5.70	35815	137.00	x	6.50	30796	141.00	x	3.65	33149	145.00	x	5.30
33103	132.00	x	6.00	34566	135.00	x	0.00	31431	137.00	x	7.00	33803	141.00	x	6.00	34596	145.00	x	5.30
34547	132.00	x	8.00	32560	135.00	x	2.00	31431	137.00	x	7.00	31195	141.00	x	6.00	33308	145.00	x	5.70
35791	132.00	x	19.00	32560	135.00	x	2.00	35816	137.00	x	8.00	31195	141.00	x	6.00	34638	145.00	x	5.70
33233	132.70	x	5.30	36926	135.00	x	2.50	32318	137.50	x	2.00	35827	141.00	x	7.00	31372	145.00	x	6.35
31778	132.72	x	5.33	34021	135.00	x	2.80	36850	138.00	x	3.00	34507	141.00	x	8.00	32357	145.00	x	6.35
35792	132.72	x	5.33	33143	135.00	x	3.00	36850	138.00	x	3.00	31511	141.00	x	9.50	32945	145.00	x	7.50
31825	132.72	x	6.99	33143	135.00	x	3.00	33896	138.00	x	3.70	30482	141.30	x	3.00	32945	145.00	x	7.50
32402	132.72	x	6.99	33143	135.00	x	3.00	30932	138.00	x	4.00	35828	141.60	x	6.00	32945	145.00	x	7.50
35793	132.72	x	6.99	33733	135.00	x	3.50	35817	138.00	x	4.00	32196	142.00	x	4.00	34336	145.00	x	8.50
35793	132.72	x	6.99	30723	135.00	x	3.50	33222	138.00	x	4.50	31125	142.00	x	5.00	35837	145.00	x	12.70
31715	132.94	x	3.53	30931	135.00	x	4.00	34198	138.00	x	5.00	33185	142.00	x	5.80	35838	145.16	x	4.14
32015	132.94	x	3.53	34557	135.00	x	4.00	35819	138.00	x	5.50	32400	142.00	x	6.50	35839	145.16	x	4.31
								31324	138.00	x	6.00	34066	142.00	x	8.00	31782	145.42	x	5.33
								33456	138.00	x	6.00	36912	142.00	x	10.00	35840	145.42	x	5.33
								33322	138.00	x	7.00	35829	142.20	x	9.00	31829	145.42	x	6.99
								33831	138.70	x	2.60	31185	142.24	x	5.33	35841	145.42	x	6.99
								30724	139.00	x	3.50	31185	142.24	x	5.33	31829	145.42	x	6.99
								32938	139.00	x	3.50	31828	142.24	x	6.99	31829	145.42	x	6.99
								30724	139.00	x	3.50	33544	142.24	x	6.99	33373	145.50	x	8.00
								31545	139.00	x	4.75	35830	142.24	x	6.99	32021	145.50	x	8.00
								35820	139.00	x	10.00	35830	142.24	x	6.99	31719	145.64	x	3.53
								31780	139.07	x	5.33	34478	142.30	x	5.70	33810	145.64	x	3.53
								31780	139.07	x	5.33	31718	142.47	x	3.53	31719	145.64	x	3.53
								35821	139.07	x	5.33	31718	142.47	x	3.53	31657	145.72	x	2.62





Cód.	Di	x	Esp.	Cód.	Di	x	Esp.	Cód.	Di	x	Esp.	Cód.	Di	x	Esp.	Cód.	Di	x	Esp.
35842	145.72	x	2.62	33990	149.00	x	6.00	31721	151.99	x	3.50	36909	157.00	x	3.00	33560	160.00	x	7.20
31657	145.72	x	2.62	35849	149.10	x	8.40	31721	151.99	x	3.53	36909	157.00	x	3.00	36290	160.00	x	7.50
33042	145.90	x	3.20	32124	149.22	x	4.76	35859	151.99	x	3.53	33734	157.00	x	6.20	35882	160.00	x	9.00
34592	146.00	x	2.00	32124	149.22	x	4.76	31721	151.99	x	3.53	34176	157.50	x	5.60	35883	160.00	x	10.00
34592	146.00	x	2.00	35850	149.23	x	4.76	34248	152.00	x	3.97	31436	157.50	x	7.00	35884	160.00	x	20.00
36476	146.00	x	3.00	35851	149.23	x	6.35	34181	152.00	x	5.60	35872	157.96	x	4.76	31482	160.50	x	8.00
34081	146.00	x	5.00	31266	149.30	x	5.70	31460	152.00	x	7.50	34331	158.00	x	4.00	31527	160.80	x	13.50
32787	146.00	x	5.70	31266	149.30	x	5.70	31658	152.07	x	2.62	34331	158.00	x	4.00	35885	161.00	x	3.50
36828	146.00	x	6.00	35852	149.50	x	5.50	35860	152.07	x	2.62	30222	158.00	x	5.00	35886	161.00	x	8.00
31432	146.00	x	7.00	31492	149.50	x	8.40	31658	152.07	x	2.62	30222	158.00	x	5.00	35887	161.30	x	5.30
31432	146.00	x	7.00	36886	150.00	x	2.00	31373	152.20	x	6.35	34419	158.00	x	5.00	33875	162.00	x	3.00
33397	146.00	x	7.00	36886	150.00	x	2.00	31374	152.20	x	6.35	35873	158.00	x	22.00	33875	162.00	x	3.00
35843	146.00	x	8.00	36889	150.00	x	2.50	32878	152.30	x	6.00	31785	158.12	x	5.33	35888	162.00	x	4.00
32016	146.05	x	1.78	36889	150.00	x	2.50	33040	152.40	x	4.00	31785	158.12	x	5.33	35889	162.00	x	9.50
32130	146.05	x	3.10	30486	150.00	x	3.00	33040	152.40	x	4.00	31785	158.12	x	5.33	32758	162.00	x	10.00
32700	146.05	x	3.10	33729	150.00	x	3.00	35861	152.40	x	4.88	31832	158.12	x	6.99	34719	162.50	x	9.50
35844	146.05	x	3.18	30485	150.00	x	3.00	35862	152.40	x	4.88	32568	158.12	x	6.99	35890	163.00	x	2.40
32729	146.05	x	6.35	30727	150.00	x	3.50	35863	152.40	x	6.00	30279	158.12	x	6.99	36307	163.00	x	2.50
35845	146.30	x	1.70	34680	150.00	x	3.50	32363	152.40	x	7.50	31832	158.12	x	6.99	32852	163.00	x	3.00
32832	146.70	x	1.80	30727	150.00	x	3.50	34679	153.00	x	3.00	31832	158.12	x	6.99	32549	163.00	x	4.00
31391	146.80	x	6.60	30935	150.00	x	4.00	34679	153.00	x	3.00	31722	158.34	x	3.53	31005	163.00	x	4.50
31325	147.00	x	3.50	30935	150.00	x	4.00	33034	153.00	x	3.50	32671	158.34	x	3.53	31005	163.00	x	4.50
30726	147.00	x	3.50	31126	150.00	x	5.00	33365	153.00	x	3.50	32582	158.34	x	3.53	33100	163.00	x	5.00
32658	147.00	x	4.00	31126	150.00	x	5.00	35864	153.00	x	5.00	31722	158.34	x	3.53	35891	163.00	x	6.30
33112	147.00	x	5.00	31126	150.00	x	5.00	32019	153.00	x	6.00	31659	158.42	x	2.62	33948	163.00	x	8.00
31779	147.00	x	5.60	33711	150.00	x	5.40	33547	153.00	x	6.00	32566	158.42	x	2.62	35892	163.40	x	3.50
30701	147.00	x	5.60	32020	150.00	x	5.40	31434	153.00	x	7.00	32572	158.42	x	2.62	35893	163.50	x	3.10
33524	147.00	x	5.80	34780	150.00	x	5.40	32379	153.50	x	3.00	31659	158.42	x	2.62	33455	163.51	x	3.10
34549	147.40	x	6.99	32598	150.00	x	6.00	32283	153.50	x	5.00	35874	158.50	x	4.00	33845	163.70	x	3.60
35846	147.60	x	8.00	32598	150.00	x	6.00	33673	153.70	x	1.78	35875	158.75	x	5.56	31437	163.80	x	7.00
32017	148.00	x	1.50	32598	150.00	x	6.00	35865	153.75	x	4.76	35876	158.75	x	6.35	32884	164.00	x	3.00
34207	148.00	x	2.00	35853	150.00	x	7.00	35866	153.90	x	6.80	35877	158.75	x	6.75	32884	164.00	x	3.00
34207	148.00	x	2.00	31481	150.00	x	8.00	33536	154.00	x	1.00	33587	158.80	x	6.30	35893	164.00	x	5.50
32481	148.00	x	2.60	33329	150.00	x	8.50	.....	154.00	x	3.00	30487	159.00	x	3.00	34261	164.00	x	7.50
35847	148.00	x	3.00	35854	150.00	x	9.50	32749	154.00	x	3.30	32181	159.00	x	6.00	32976	164.00	x	8.00
33258	148.00	x	3.50	35855	150.00	x	12.70	32548	154.00	x	3.30	33991	159.00	x	9.00	33740	164.00	x	11.00
33193	148.00	x	4.00	31433	150.80	x	7.00	30937	154.00	x	4.00	33991	159.00	x	9.00	35894	164.20	x	5.70
33193	148.00	x	4.00	36927	151.00	x	3.00	33383	154.00	x	5.00	35878	159.10	x	8.40	31268	164.30	x	5.70
31326	148.00	x	6.00	35856	151.00	x	6.00	34270	154.00	x	6.00	32238	159.30	x	5.70	31268	164.30	x	5.70
32977	148.00	x	8.00	35857	151.00	x	9.50	31435	154.00	x	7.00	32648	159.30	x	5.70	31268	164.30	x	5.70
33033	148.40	x	4.80	33614	151.50	x	3.00	33551	154.00	x	7.30	32143	159.30	x	5.70	31187	164.47	x	5.33
34518	148.59	x	5.33	35858	151.50	x	3.20	35867	154.00	x	8.00	30488	159.50	x	3.00	31188	164.47	x	5.33
31783	148.59	x	5.33	31186	151.70	x	5.30	31927	154.10	x	5.70	33444	159.50	x	8.40	31187	164.47	x	5.33
34518	148.59	x	5.33	31186	151.77	x	5.33	31267	154.30	x	5.70	35879	159.54	x	11.91	31833	164.47	x	6.99
31830	148.59	x	6.99	33163	151.77	x	5.33	31267	154.30	x	5.70	32826	160.00	x	1.50	35895	164.47	x	6.99
35848	148.59	x	6.99	32324	151.77	x	5.33	33128	154.60	x	4.76	31540	160.00	x	2.00	31833	164.47	x	6.99
31830	148.59	x	6.99	33163	151.77	x	5.33	34354	155.00	x	2.50	34625	160.00	x	2.00	34004	164.50	x	4.00
30781	148.82	x	3.53	31831	151.77	x	6.99	34354	155.00	x	2.50	34328	160.00	x	2.50	33382	164.50	x	4.80
31720	148.82	x	3.53	34686	151.77	x	6.99	32692	155.00	x	3.00	34569	160.00	x	2.50	33811	164.50	x	4.80
30781	148.82	x	3.53	34756	151.77	x	6.99	32692	155.00	x	3.00	33731	160.00	x	3.00	34184	164.50	x	7.00
31720	148.82	x	3.53	31831	151.77	x	6.99	33136	155.00	x	3.20	32244	160.00	x	3.00	31723	164.69	x	3.53
33110	149.00	x	3.00	32535	151.99	x	2.62	32210	155.00	x	3.50	33731	160.00	x	3.00	35896	164.69	x	3.53
33110	149.00	x	3.00	32535	151.99	x	2.62	33893	155.00	x	4.00	33731	160.00	x	3.00	31723	164.69	x	3.53
33110	149.00	x	3.00	31721	151.99	x	3.50	33893	155.00	x	4.00	32451	160.00	x	3.20	31723	164.70	x	3.53
34037	149.00	x	4.30	31721	151.99	x	3.50	35868	155.00	x	4.30	32399	160.00	x	3.50	33094	164.70	x	3.53
								35869	155.00	x	5.00	30938	160.00	x	4.00	31723	164.70	x	3.53
								33467	155.00	x	5.30	30938	160.00	x	4.00	31660	164.77	x	2.62
								33807	155.00	x	5.50	33433	160.00	x	4.80	34062	164.77	x	2.62
								31327	155.00	x	6.00	31127	160.00	x	5.00	31660	164.77	x	2.62
								35870	155.20	x	7.20	31127	160.00	x	5.00	33644	165.00	x	2.00
								32379	155.40	x	3.00	32724	160.00	x	5.00	32342	165.00	x	3.00
								31024	155.53	x	4.76	33468	160.00	x	5.30	32342	165.00	x	3.00
								35871	156.00	x	2.00	33542	160.00	x	5.50	32513	165.00	x	4.00
								35871	156.00	x	2.00	35880	160.00	x	5.70	32513	165.00	x	4.00
								36459	156.00	x	3.00	35881	160.00	x	6.00	33574	165.00	x	5.00
								33337	156.00	x	4.90	33560	160.00	x	7.00	32969	165.00	x	5.00
								33141	156.00	x	6.00	33560	160.00	x	7.20	32969	165.00	x	5.00



# Anéis



INCOVE VEDAÇÕES LTDA.

Cód.	Di	x	Esp.	Cód.	Di	x	Esp.	Cód.	Di	x	Esp.	Cód.	Di	x	Esp.	Cód.	Di	x	Esp.
33654	165.00	x	5.30	31543	170.00	x	5.00	33869	174.00	x	8.00	30489	180.00	x	3.00	35936	185.00	x	15.00
33758	165.00	x	5.50	33432	170.00	x	5.50	33721	174.30	x	5.70	30728	180.00	x	3.50	32632	186.00	x	3.50
31328	165.00	x	6.00	31329	170.00	x	6.00	33776	174.30	x	5.70	30945	180.00	x	4.00	34683	186.00	x	3.50
31328	165.00	x	6.00	34620	170.00	x	6.00	34451	174.50	x	3.00	30945	180.00	x	4.00	33543	186.00	x	4.00
31328	165.00	x	6.00	31329	170.00	x	6.00	32510	174.50	x	5.30	34581	180.00	x	4.00	33543	186.00	x	4.00
31898	165.00	x	8.50	35907	170.00	x	7.00	35916	174.50	x	6.00	31129	180.00	x	5.00	33453	186.00	x	5.00
35897	165.10	x	9.53	35908	170.00	x	8.00	36465	175.00	x	2.00	31129	180.00	x	5.00	31130	186.00	x	5.00
30401	165.20	x	9.60	34506	170.00	x	10.00	32718	175.00	x	3.00	32287	180.00	x	5.50	36478	186.00	x	6.50
35898	165.33	x	6.35	36324	170.00	x	12.70	32718	175.00	x	3.00	31786	180.00	x	6.00	35937	186.00	x	7.00
33293	165.50	x	7.50	31189	170.82	x	5.33	32501	175.00	x	3.50	31439	180.00	x	7.00	33061	187.00	x	5.50
32925	165.50	x	7.50	31787	170.82	x	5.33	32450	175.00	x	4.30	33353	180.00	x	7.00	35938	187.00	x	6.20
33064	165.90	x	5.90	31189	170.82	x	5.33	31128	175.00	x	5.00	31439	180.00	x	7.00	31484	187.00	x	8.00
33644	166.00	x	2.00	31189	170.82	x	5.33	31146	175.00	x	5.20	31885	180.00	x	8.00	35940	187.00	x	10.00
31872	166.00	x	3.00	31189	170.82	x	5.33	31162	175.00	x	5.30	35926	180.00	x	10.00	31441	187.30	x	7.00
31872	166.00	x	3.00	31834	170.82	x	6.99	34435	175.00	x	5.50	33372	181.00	x	5.00	36928	187.80	x	4.00
31483	166.00	x	8.00	33377	170.82	x	6.99	35916	175.00	x	5.50	33362	181.00	x	6.00	36813	188.00	x	2.00
36832	166.00	x	12.00	35909	170.82	x	6.99	33735	175.00	x	6.00	31398	181.00	x	6.99	33876	188.00	x	3.00
36442	167.00	x	3.00	35909	170.82	x	6.99	35917	175.00	x	6.60	33891	181.00	x	7.00	33066	188.00	x	5.20
35898	167.00	x	3.50	34064	171.00	x	3.50	35918	175.00	x	7.00	31517	181.50	x	10.00	35941	188.00	x	6.00
30939	167.00	x	4.00	34064	171.00	x	3.50	33954	175.00	x	8.00	32732	182.00	x	3.00	35942	188.50	x	4.00
33704	167.00	x	6.35	34064	171.00	x	3.50	33571	175.50	x	9.00	32732	182.00	x	3.00	33880	189.00	x	5.50
31042	167.20	x	4.90	35910	171.00	x	11.00	35919	176.00	x	3.50	33779	182.00	x	3.50	33880	189.00	x	5.50
35899	167.30	x	6.35	31724	171.04	x	3.53	35920	176.00	x	4.30	33843	182.00	x	3.50	33287	189.00	x	6.50
34380	168.00	x	3.00	35911	171.04	x	3.53	34393	176.00	x	5.00	33098	182.00	x	5.00	31388	189.00	x	6.50
33785	168.00	x	3.50	31724	171.04	x	3.53	34154	176.00	x	6.00	33319	182.00	x	6.00	31461	189.00	x	7.50
33863	168.00	x	4.00	31661	171.12	x	2.62	36913	176.00	x	10.00	31331	182.00	x	7.00	32023	189.00	x	7.50
33863	168.00	x	4.00	33886	171.12	x	2.62	32540	176.80	x	3.60	32386	182.00	x	9.00	33195	189.10	x	8.40
34282	168.00	x	7.00	31661	171.12	x	2.62	34548	177.00	x	2.00	35927	182.00	x	11.00	31271	189.30	x	5.70
32170	168.27	x	4.76	31661	171.12	x	2.62	32761	177.00	x	3.00	33235	182.50	x	5.70	31271	189.30	x	5.70
35900	168.28	x	3.97	34134	171.45	x	4.76	32141	177.00	x	3.50	33116	182.82	x	2.62	31271	189.30	x	5.70
35901	168.30	x	3.20	33871	171.45	x	5.60	31835	177.16	x	6.99	32455	183.00	x	3.20	33101	189.80	x	5.33
35902	169.00	x	3.60	34302	171.45	x	6.35	33122	177.16	x	6.99	31399	183.00	x	6.99	33101	189.80	x	5.33
35903	169.00	x	3.60	35912	171.45	x	7.14	34739	177.16	x	6.99	31331	183.00	x	6.99	34595	189.80	x	8.00
35904	169.00	x	8.70	33121	171.86	x	2.97	31788	177.17	x	5.33	35928	183.50	x	3.00	31790	189.87	x	5.33
33196	169.10	x	8.40	33827	172.00	x	4.00	31788	177.17	x	5.33	31440	183.50	x	7.00	35943	189.87	x	5.33
30940	169.30	x	4.00	33827	172.00	x	4.00	31788	177.17	x	5.33	32022	183.52	x	5.33	31790	189.87	x	5.33
31269	169.30	x	5.70	32899	172.00	x	8.00	31788	177.17	x	5.33	32022	183.52	x	5.33	32790	189.87	x	6.35
32589	169.30	x	5.70	32766	173.00	x	3.00	31885	177.17	x	6.99	31836	183.52	x	6.99	31837	189.87	x	6.99
31269	169.30	x	5.70	32766	173.00	x	3.00	35920	177.17	x	6.99	33809	183.52	x	6.99	32024	189.87	x	6.99
34208	169.80	x	4.30	34517	173.00	x	3.70	31885	177.17	x	6.99	33809	183.52	x	6.99	34687	189.87	x	6.99
35905	169.80	x	6.10	32717	173.00	x	4.50	31725	177.39	x	3.53	32044	183.74	x	3.53	32024	189.87	x	6.99
32597	170.00	x	1.80	33577	173.00	x	5.00	33090	177.39	x	3.53	31726	183.74	x	3.53	32051	190.00	x	2.40
34038	170.00	x	2.00	33861	173.00	x	6.00	30772	177.39	x	3.53	32044	183.74	x	3.53	36472	190.00	x	2.50
34038	170.00	x	2.00	33693	173.00	x	7.00	31725	177.39	x	3.53	31726	183.74	x	3.53	36848	190.00	x	3.00
31899	170.00	x	2.40	34187	173.00	x	9.00	31725	177.39	x	3.53	33942	183.80	x	4.20	36848	190.00	x	3.00
36407	170.00	x	2.50	32904	173.80	x	2.40	31662	177.47	x	2.62	31663	183.82	x	2.62	30946	190.00	x	4.00
35906	170.00	x	3.00	_____	173.80	x	5.20	31662	177.47	x	2.62	32246	183.82	x	2.62	30946	190.00	x	4.00
35906	170.00	x	3.00	33905	174.00	x	3.00	33025	177.60	x	5.00	36496	184.00	x	5.00	34157	190.00	x	4.50
30518	170.00	x	3.17	33905	174.00	x	3.00	33025	177.60	x	5.00	35928	184.00	x	6.00	32327	190.00	x	5.00
30518	170.00	x	3.17	35913	174.00	x	4.00	33095	177.80	x	2.97	35929	184.00	x	8.00	32675	190.00	x	5.00
33257	170.00	x	3.50	35914	174.00	x	5.00	33572	177.80	x	3.30	33717	184.10	x	8.40	32327	190.00	x	5.00
33257	170.00	x	3.50	33275	174.00	x	5.25	30943	177.80	x	4.00	35930	184.10	x	8.40	35944	190.00	x	5.70
30941	170.00	x	4.00	33415	174.00	x	5.25	31031	177.80	x	4.76	34312	184.15	x	4.76	35945	190.00	x	6.00
30942	170.00	x	4.00	31330	174.00	x	6.00	33968	177.80	x	6.35	34634	184.15	x	4.76	35946	190.00	x	8.00
34561	170.00	x	4.50	35915	174.00	x	7.00	35922	177.80	x	7.94	34334	184.30	x	5.70	35947	190.00	x	9.80
								35923	178.00	x	6.50	31270	184.30	x	5.70	35948	190.00	x	18.00
								31438	178.00	x	7.00	35931	185.00	x	2.00	31727	190.09	x	3.53
								32551	178.00	x	8.00	32764	185.00	x	3.00	36819	190.09	x	3.53
								35924	179.00	x	3.00	32764	185.00	x	3.00	36819	190.09	x	3.53
								35925	179.10	x	8.40	34564	185.00	x	4.00	31727	190.09	x	3.53
								32470	179.20	x	5.70	35933	185.00	x	5.00	35949	190.10	x	6.75
								32470	179.20	x	5.70	33647	185.00	x	5.30	31664	190.17	x	2.62
								35926	179.39	x	4.76	33642	185.00	x	6.00	31664	190.17	x	2.62
								36470	180.00	x	1.50	33897	185.00	x	6.50	32025	190.50	x	3.00
								34513	180.00	x	2.50	35934	185.00	x	6.60	32415	190.50	x	3.00
								30489	180.00	x	3.00	33865	185.00	x	8.00	35950	190.50	x	6.35
								34767	180.00	x	3.00	35935	185.00	x	12.50	35951	190.50	x	7.50





# Anéis



INCOVE VEDAÇÕES LTDA.

Cód.	Di	x	Esp.	Cód.	Di	x	Esp.	Cód.	Di	x	Esp.	Cód.	Di	x	Esp.	Cód.	Di	x	Esp.
32026	190.50	x	8.00	33995	196.52	x	2.62	34738	202.60	x	7.00	33239	209.00	x	3.00	31731	215.49	x	3.53
33417	190.50	x	8.00	34071	196.60	x	6.35	31442	202.60	x	7.00	31274	209.00	x	5.70	31731	215.49	x	3.53
33147	191.00	x	5.50	34358	196.85	x	2.38	31729	202.79	x	3.53	32526	209.00	x	5.70	31731	215.49	x	3.53
35952	191.00	x	8.00	30492	197.00	x	3.00	31729	202.79	x	3.53	35981	209.10	x	8.40	31731	215.49	x	3.53
30171	192.00	x	2.00	34180	197.00	x	5.80	31729	202.79	x	3.53	31730	209.14	x	3.53	31668	215.57	x	2.62
30069	192.00	x	3.00	31503	197.00	x	9.00	35970	202.79	x	3.53	31730	209.14	x	3.53	35995	215.57	x	2.62
30069	192.00	x	3.00	33255	197.50	x	3.50	31729	202.79	x	3.53	31730	209.14	x	3.53	33678	215.88	x	6.35
30947	192.00	x	4.00	33987	197.50	x	5.70	31666	202.87	x	2.62	36351	209.14	x	3.53	32429	215.88	x	6.35
33646	193.00	x	4.00	34015	197.80	x	6.50	31666	202.87	x	2.62	32337	209.20	x	2.60	34054	215.90	x	2.00
31006	193.00	x	4.50	36486	198.00	x	5.00	30494	203.00	x	3.00	34463	209.20	x	5.00	33962	215.90	x	4.76
30913	193.00	x	5.00	35958	198.00	x	5.60	30494	203.00	x	3.00	35982	209.20	x	6.00	35996	215.90	x	6.35
32913	193.00	x	5.00	35959	198.00	x	6.00	30948	203.00	x	4.00	31667	209.22	x	2.62	35997	216.00	x	3.00
33980	193.00	x	7.00	33500	198.00	x	7.00	31389	203.00	x	6.50	35983	209.22	x	2.62	32964	216.00	x	5.00
33979	193.00	x	7.00	34059	198.50	x	10.00	33045	203.00	x	10.00	33072	209.40	x	4.70	31336	216.00	x	6.00
30491	194.00	x	3.00	35960	198.80	x	4.00	36934	203.00	x	18.00	35984	209.50	x	8.00	32834	216.90	x	2.10
30491	194.00	x	3.00	34390	199.00	x	4.50	36844	203.20	x	6.99	33443	209.50	x	8.40	36453	217.00	x	3.00
32604	194.00	x	6.00	33237	199.00	x	6.10	31449	203.20	x	7.14	32669	209.55	x	7.94	32547	217.00	x	5.00
34586	194.00	x	6.35	31273	199.30	x	5.70	34550	203.20	x	8.00	35985	209.55	x	10.32	32547	217.00	x	5.00
35953	194.00	x	10.50	34587	199.30	x	5.70	34550	203.20	x	8.00	36436	210.00	x	2.70	33032	217.00	x	6.30
33234	194.10	x	8.40	35961	199.50	x	8.40	33788	203.20	x	12.70	33580	210.00	x	3.00	33996	217.00	x	7.00
31272	194.30	x	5.70	33361	199.60	x	6.10	33402	204.00	x	4.50	34673	210.00	x	3.00	31337	217.50	x	6.00
34056	194.69	x	3.53	30493	200.00	x	3.00	35971	204.00	x	6.00	30949	210.00	x	4.00	35998	218.00	x	5.00
32733	195.00	x	2.50	30493	200.00	x	3.00	36479	204.00	x	6.50	30950	210.00	x	4.00	33364	218.00	x	5.30
32733	195.00	x	2.50	30519	200.00	x	3.17	31529	204.00	x	14.00	32078	210.00	x	4.50	33996	218.00	x	7.00
35954	195.00	x	2.80	30519	200.00	x	3.17	36883	205.00	x	2.00	32274	210.00	x	4.50	35999	218.00	x	12.00
30491	195.00	x	3.00	32453	200.00	x	3.50	36883	205.00	x	2.00	31132	210.00	x	5.00	33645	218.50	x	4.50
30491	195.00	x	3.00	33388	200.00	x	3.50	36497	205.00	x	3.00	33290	210.00	x	5.00	34412	218.50	x	6.99
36430	195.00	x	3.50	32345	200.00	x	4.00	35972	205.00	x	3.20	34027	210.00	x	6.50	31354	219.00	x	6.30
33503	195.00	x	4.00	31007	200.00	x	4.50	33643	205.00	x	4.00	33370	210.00	x	7.00	31275	219.30	x	5.70
31879	195.00	x	4.50	35962	200.00	x	4.80	33126	205.00	x	5.00	32924	210.00	x	8.00	34774	219.30	x	5.70
31131	195.00	x	5.00	33348	200.00	x	5.00	34777	205.00	x	5.00	32924	210.00	x	8.00	36000	219.50	x	20.00
31131	195.00	x	5.00	33348	200.00	x	5.00	33966	205.00	x	5.50	33230	211.00	x	2.00	34546	220.00	x	2.00
31248	195.00	x	5.60	33691	200.00	x	5.30	33966	205.00	x	5.50	36362	212.00	x	2.50	34546	220.00	x	2.00
32968	195.00	x	6.00	34783	200.00	x	5.30	35973	205.00	x	7.00	36362	212.00	x	2.50	32967	220.00	x	3.00
33975	195.00	x	8.00	34345	200.00	x	6.00	35974	205.00	x	7.50	33775	212.00	x	3.50	32967	220.00	x	3.00
35955	195.00	x	20.00	32333	200.00	x	6.00	35975	205.00	x	10.00	33612	212.00	x	3.50	36001	220.00	x	3.20
33842	195.50	x	5.70	34345	200.00	x	6.00	31334	205.20	x	6.00	34464	212.00	x	3.50	33259	220.00	x	3.50
32027	196.00	x	3.50	35963	200.00	x	7.20	34474	205.98	x	3.53	34036	212.00	x	5.30	32344	220.00	x	4.00
30729	196.00	x	3.50	35964	200.00	x	8.00	32965	206.00	x	3.00	32080	212.00	x	6.00	32344	220.00	x	4.00
33828	196.00	x	4.00	35965	200.00	x	9.00	33001	206.00	x	6.00	34411	212.00	x	6.50	31008	220.00	x	4.50
33627	196.00	x	4.00	33976	200.00	x	9.50	33824	206.00	x	7.00	35986	212.08	x	6.99	31034	220.00	x	4.76
31791	196.00	x	5.30	33420	200.00	x	9.50	33354	206.00	x	12.00	36412	212.50	x	5.70	31034	220.00	x	4.76
31791	196.00	x	5.30	35966	200.00	x	10.00	36829	206.00	x	18.00	33026	212.70	x	4.00	36936	220.00	x	5.00
35956	196.00	x	12.00	35967	200.00	x	32.00	32473	206.37	x	6.35	33041	213.00	x	4.80	36936	220.00	x	5.00
31791	196.22	x	5.33	35968	200.03	x	3.18	35976	206.38	x	1.59	31133	213.00	x	5.00	36002	220.00	x	5.50
31791	196.22	x	5.33	31400	200.10	x	6.99	35977	206.38	x	5.56	31133	213.00	x	5.00	31338	220.00	x	6.00
31838	196.22	x	6.99	33076	201.30	x	3.30	34445	207.00	x	2.00	35987	213.50	x	3.50	34545	220.00	x	7.00
32574	196.22	x	6.99	34531	202.00	x	4.00	33130	207.00	x	3.50	35989	214.00	x	4.00	33341	220.00	x	7.50
32569	196.22	x	6.99	31792	202.57	x	5.33	32605	207.00	x	3.50	36480	214.00	x	5.00	36003	220.00	x	8.00
31791	196.22	x	6.99	33158	202.57	x	5.33	31211	207.00	x	5.40	33075	214.00	x	5.50	36956	221.00	x	8.40
31728	196.44	x	3.53	31792	202.57	x	5.33	35978	207.00	x	7.00	35990	214.00	x	6.00	31339	221.50	x	6.00
35957	196.44	x	3.53	31792	202.57	x	5.33	35979	207.00	x	8.50	35991	214.50	x	8.40	31795	221.62	x	5.33
31728	196.44	x	3.53	31839	202.57	x	6.99	34126	207.00	x	9.50	30495	215.00	x	3.00	31795	221.62	x	5.33
31665	196.52	x	2.62	35969	202.57	x	6.99	35980	207.96	x	5.16	30495	215.00	x	3.00	31795	221.62	x	5.33
33995	196.52	x	2.62	31442	202.60	x	7.00	32457	208.00	x	3.20	34483	215.00	x	5.00	31732	221.84	x	3.53
								32427	208.00	x	3.20	34483	215.00	x	5.00	31732	221.84	x	3.53
								34014	208.00	x	4.00	31335	215.00	x	6.00	31732	221.84	x	3.53
								31018	208.00	x	4.70	35992	215.00	x	10.00	31669	221.92	x	2.62
								34462	208.00	x	5.00	35993	215.00	x	19.00	36004	221.92	x	2.62
								34462	208.00	x	5.00	31194	215.27	x	5.33	34546	222.00	x	2.00
								34432	208.00	x	5.80	31191	215.27	x	5.33	36005	222.00	x	3.20
								31548	208.00	x	6.00	31794	215.27	x	5.33	36471	222.00	x	4.00
								31548	208.00	x	6.00	31194	215.27	x	5.33		222.00	x	7.00
								32946	208.00	x	7.00	31840	215.27	x	6.99	33732	222.00	x	7.00
								33194	208.00	x	8.30	31840	215.27	x	6.99	36006	222.22	x	11.11
								31793	208.92	x	5.33	33048	215.27	x	6.99	36007	223.00	x	6.00
								34005	208.92	x	5.33	35994	215.27	x	6.99	36008	223.00	x	7.00





# Anéis



INCOVE VEDAÇÕES LTDA.

Cód.	Di	x	Esp.	Cód.	Di	x	Esp.	Cód.	Di	x	Esp.	Cód.	Di	x	Esp.	Cód.	Di	x	Esp.
36009	223.00	x	7.00	32480	230.00	x	6.00	33371	238.00	x	6.00	34000	247.02	x	5.33	33525	256.50	x	5.00
33230	224.00	x	3.50	34727	230.00	x	6.00	31453	238.00	x	7.30	34740	247.02	x	5.33	33676	256.50	x	5.40
30561	224.00	x	3.80	32480	230.00	x	6.00	33600	238.00	x	7.30	34019	247.20	x	7.00	33676	256.50	x	5.40
32801	224.00	x	6.99	36018	230.00	x	7.90	32847	238.50	x	6.99	31736	247.24	x	3.53	34152	257.00	x	2.00
32801	224.00	x	6.99	31485	230.00	x	8.00	32142	239.10	x	5.70	30764	247.24	x	3.53	34379	257.00	x	2.62
36010	224.00	x	8.00	36019	230.00	x	9.00	31276	239.30	x	5.70	31736	247.24	x	3.53	36385	257.00	x	5.00
34188	224.50	x	8.40	32940	230.00	x	10.00	31276	239.30	x	5.70	31736	247.24	x	3.53	36060	257.00	x	8.00
36011	224.79	x	6.99	32456	231.00	x	3.20	30496	240.00	x	3.00	31673	247.32	x	2.62	33651	258.00	x	4.00
36856	225.00	x	3.00	32418	231.00	x	3.20	34627	240.00	x	3.00	31673	247.32	x	2.62	33651	258.00	x	4.00
36012	225.00	x	4.00	34552	231.00	x	3.50	30953	240.00	x	4.00	36043	247.60	x	11.00	36061	258.00	x	7.00
33363	225.00	x	5.00	34003	231.00	x	8.00	30953	240.00	x	4.00	36044	248.00	x	7.20	33501	259.00	x	3.20
33705	225.00	x	5.00	34003	231.00	x	8.00	33832	240.00	x	5.00	32503	249.00	x	3.50	32438	259.00	x	3.50
34520	225.00	x	5.00	36431	232.00	x	3.00	34573	240.00	x	5.00	36045	249.00	x	5.00	34466	259.00	x	3.50
31549	225.00	x	6.00	30952	232.00	x	4.00	31340	240.00	x	6.00	30955	249.20	x	4.00	31278	259.30	x	5.70
31549	225.00	x	6.00	32439	232.00	x	4.30	31340	240.00	x	6.00	31277	249.30	x	5.70	31278	259.30	x	5.70
31401	225.00	x	6.99	32430	232.00	x	4.30	33066	240.00	x	7.50	32987	249.30	x	5.70	31278	259.30	x	5.70
31401	225.00	x	6.99	34485	232.00	x	5.00	36029	240.00	x	9.10	36046	249.50	x	8.40	36062	259.50	x	8.40
30951	226.00	x	4.00	34394	232.00	x	5.00	32991	240.00	x	10.00	30498	250.00	x	3.00	31443	259.70	x	7.00
34216	226.00	x	7.00	32452	232.00	x	7.00	31798	240.67	x	5.33	30498	250.00	x	3.00	36925	260.00	x	2.50
31463	226.00	x	7.80	36020	232.00	x	12.00	33316	240.67	x	5.33	33550	250.00	x	4.00	36063	260.00	x	2.60
31463	226.00	x	7.80	36021	232.00	x	12.00	31798	240.67	x	5.33	30956	250.00	x	4.00	34077	260.00	x	3.00
34237	227.00	x	3.10	32332	233.00	x	3.00	31842	240.67	x	6.99	33102	250.00	x	5.00	34077	260.00	x	3.00
33993	227.50	x	10.00	32332	233.00	x	3.00	31842	240.67	x	6.99	33985	250.00	x	5.30	34077	260.00	x	3.00
32425	227.80	x	7.00	32228	233.00	x	7.00	32563	240.67	x	6.99	31341	250.00	x	6.00	32662	260.00	x	5.00
31796	227.97	x	5.33	36022	233.00	x	8.00	32390	240.67	x	6.99	34700	250.00	x	6.00	32662	260.00	x	5.00
31796	227.97	x	5.33	31797	234.32	x	5.33	31842	240.67	x	6.99	34177	250.00	x	7.00	32662	260.00	x	5.00
31841	227.97	x	6.99	33801	234.32	x	5.33	31735	240.89	x	3.53	36047	250.00	x	8.00	32974	260.00	x	6.00
31841	227.97	x	6.99	31797	234.32	x	5.33	31777	240.89	x	3.53	36048	250.00	x	12.00	36064	260.00	x	7.00
32309	227.97	x	6.99	36023	234.32	x	6.99	31735	240.89	x	3.53	36049	250.00	x	15.00	36065	260.00	x	7.50
31841	227.97	x	6.99	36024	234.50	x	8.40	31735	240.89	x	3.53	36050	250.44	x	1.78	33770	260.00	x	8.00
31841	227.97	x	6.99	31734	234.54	x	0.00	31672	240.97	x	2.62	36051	250.80	x	10.00	34567	260.00	x	8.00
36013	228.00	x	4.00	31734	234.54	x	3.53	32562	240.97	x	2.62	36853	251.00	x	7.00	33346	260.00	x	10.00
36014	228.00	x	4.30	33219	234.54	x	3.53	32389	240.97	x	2.62	36052	252.00	x	2.00	36066	260.00	x	15.00
33931	228.00	x	5.00	31734	234.54	x	3.53	31672	240.97	x	2.62	36053	252.00	x	4.00	36067	260.35	x	3.18
33931	228.00	x	5.00	31734	234.54	x	3.53	36030	241.20	x	10.00	33044	252.00	x	5.20	36068	260.35	x	12.70
33936	228.00	x	10.00	34281	234.60	x	6.90	33978	241.30	x	6.35	34203	252.00	x	6.00	36069	261.00	x	1.70
31733	228.19	x	3.53	31671	234.62	x	2.62	36031	241.30	x	19.05	34210	252.00	x	6.50	30957	261.00	x	4.00
32066	228.19	x	3.53	36025	234.62	x	2.62	33046	241.60	x	5.50	36054	252.41	x	11.11	36070	261.40	x	10.00
32602	228.19	x	3.53	36026	234.95	x	9.53	36032	241.70	x	6.75	34001	253.37	x	5.30	30499	262.00	x	3.00
31733	228.19	x	3.53	34784	235.00	x	2.00	34146	242.00	x	2.40	31800	253.37	x	5.33	36071	262.00	x	10.50
31670	228.27	x	2.62	33914	235.00	x	3.00	36033	242.00	x	4.00	36055	253.37	x	5.33	36072	262.40	x	6.80
36015	228.27	x	2.62	36027	235.00	x	5.00	36034	242.89	x	6.75	31843	253.37	x	6.99	33927	263.00	x	5.50
36016	228.60	x	6.35	34020	235.00	x	5.80	32375	243.00	x	5.50	32702	253.37	x	6.99	36073	263.00	x	6.00
33915	228.60	x	6.50	31375	235.00	x	6.35	36035	243.00	x	6.00	31843	253.37	x	6.99	36074	263.00	x	8.50
31043	228.80	x	4.90	33841	235.00	x	7.00	36312	244.00	x	2.00	33757	253.37	x	7.49	36075	263.00	x	11.50
31493	229.10	x	8.40	33935	235.50	x	6.00	36312	244.00	x	2.00	34275	253.50	x	3.50	30958	263.50	x	4.00
33703	229.30	x	5.70	32581	236.00	x	3.50	34221	244.08	x	3.53	31737	253.59	x	3.53	36076	263.50	x	7.00
32986	229.30	x	5.70	33339	236.00	x	4.00	36036	244.08	x	5.56	36056	253.59	x	3.53	36077	263.53	x	4.76
36017	230.00	x	3.00	36028	236.00	x	5.50	33460	244.30	x	5.70	31737	253.59	x	3.53	36078	264.30	x	10.00
36891	230.00	x	4.00	36466	238.00	x	2.00	36037	244.50	x	6.00	34010	254.00	x	3.00	32381	265.00	x	2.50
36891	230.00	x	4.00	33380	238.00	x	3.00	32179	245.00	x	4.00	34010	254.00	x	3.00	30500	265.00	x	3.00
31044	230.00	x	4.90	32667	238.00	x	3.50	36038	245.00	x	4.40	31009	254.00	x	4.50	30500	265.00	x	3.00
31134	230.00	x	5.00	33343	238.00	x	4.00	33967	245.00	x	5.00	32030	254.00	x	6.35	30500	265.00	x	3.00
31135	230.00	x	5.00	33343	238.00	x	4.00	33967	245.00	x	5.00	31376	254.00	x	6.35	33526	265.00	x	3.70
32029	230.00	x	5.00	32370	238.00	x	5.00	32469	245.00	x	7.50	31486	254.00	x	8.00	32371	265.00	x	4.00
								32300	245.00	x	8.00	34773	254.00	x	8.00	32371	265.00	x	4.00
								30320	245.10	x	2.70	36057	254.00	x	9.80	33916	265.00	x	4.90
								30497	246.00	x	3.00	33748	254.50	x	8.40	33916	265.00	x	4.90
								30954	246.00	x	4.00	33748	254.50	x	8.40	32365	265.00	x	7.00
								36039	246.00	x	7.00	36404	255.00	x	2.00	36079	266.00	x	5.00
								36040	246.00	x	8.00	31784	255.00	x	4.00	36080	266.00	x	6.00
								36041	246.00	x	16.00	32693	255.00	x	5.00	31402	266.00	x	6.99
								30288	247.00	x	2.50	32693	255.00	x	5.00	33150	266.07	x	5.33
								34178	247.00	x	5.50	36058	255.00	x	5.70	31801	266.07	x	5.33
								32877	247.00	x	7.00	32458	256.00	x	4.80	31801	266.07	x	5.55
								36042	247.00	x	11.00	32426	256.00	x	4.80	31844	266.07	x	6.99
								31799	247.02	x	5.33	36059	256.00	x	5.00	31402	266.07	x	6.99







# Anéis



INCOVE VEDAÇÕES LTDA.

Cód.	Di	x	Esp.	Cód.	Di	x	Esp.	Cód.	Di	x	Esp.	Cód.	Di	x	Esp.	Cód.	Di	x	Esp.
34503	266.20	x	3.50	34730	277.00	x	3.17	36103	284.00	x	3.00	31404	297.81	x	6.99	33951	310.00	x	5.30
31738	266.29	x	3.53	34760	277.00	x	3.17	36104	284.00	x	3.50	30503	298.00	x	3.00	33047	310.00	x	6.00
36081	266.29	x	3.53	32032	277.00	x	4.00	31137	284.00	x	5.00	33963	298.00	x	3.50	32299	310.00	x	8.00
31738	266.29	x	3.53	30961	277.00	x	4.00	34344	284.00	x	5.50	33946	298.00	x	4.00	32299	310.00	x	8.00
34149	266.70	x	4.76	36091	277.00	x	5.00	34582	284.40	x	5.55	33974	298.00	x	9.70	36134	310.00	x	8.30
31894	266.70	x	5.33	31522	277.00	x	11.10	36105	284.50	x	8.40	36120	298.00	x	10.00	34070	310.00	x	8.50
33340	266.70	x	6.35	32556	277.10	x	6.80	33862	285.00	x	3.00	36121	298.45	x	2.62	34490	310.00	x	9.00
36082	266.70	x	12.70	36092	277.50	x	7.00	33862	285.00	x	3.00	36122	298.45	x	11.11	36135	310.13	x	6.99
31342	267.00	x	6.00	32534	277.80	x	7.00	30962	285.00	x	4.00	36123	299.30	x	5.70	36137	310.50	x	10.00
32557	267.38	x	2.90	32534	277.80	x	7.00	30962	285.00	x	4.00	31279	299.37	x	5.70	36138	310.51	x	5.33
31343	268.00	x	6.00	32580	277.90	x	2.90	36106	285.00	x	5.00	32982	299.37	x	5.70	36139	310.85	x	2.62
30731	269.00	x	3.50	36432	278.00	x	4.00	33483	285.00	x	6.00	34063	300.00	x	2.00	36140	311.15	x	3.53
33421	269.10	x	8.40	36093	278.00	x	8.00	33217	285.00	x	7.00	34030	300.00	x	2.50	33947	312.00	x	4.00
33421	269.10	x	8.40	34120	278.50	x	7.50	36107	285.11	x	6.99	31918	300.00	x	3.00	36141	312.50	x	23.50
32746	269.87	x	6.35	31802	278.77	x	5.33	32997	285.75	x	9.52	32663	300.00	x	3.28	34383	313.50	x	3.00
36083	269.88	x	3.18	31802	278.77	x	5.33	33493	286.00	x	6.00	32034	300.00	x	4.00	36142	313.53	x	12.70
30501	270.00	x	3.00	31802	278.77	x	5.33	32441	286.00	x	7.00	30963	300.00	x	4.00	34384	313.55	x	3.00
33698	270.00	x	3.20	31802	278.77	x	5.33	32424	286.00	x	7.00	33706	300.00	x	5.00	34347	314.00	x	3.00
33698	270.00	x	3.20	31845	278.77	x	6.99	32096	287.00	x	8.00	33160	300.00	x	6.00	34431	314.00	x	3.00
30959	270.00	x	4.00	33381	278.77	x	6.99	32096	287.00	x	8.00	32035	300.00	x	8.00	36143	314.00	x	5.00
30959	270.00	x	4.00	31845	278.77	x	6.99	36108	288.00	x	4.00	33982	300.00	x	9.00	34075	315.00	x	4.00
33502	270.00	x	5.00	31845	278.77	x	6.99	32446	288.00	x	4.80	36124	300.00	x	10.00	34630	315.00	x	4.00
33695	270.00	x	5.00	31881	278.79	x	3.53	32419	288.00	x	4.80	36125	300.60	x	11.40	32271	315.00	x	5.00
33707	270.00	x	5.33	33648	278.79	x	3.53	33496	288.00	x	7.00	33532	302.00	x	4.00	33349	315.00	x	5.00
32431	270.00	x	5.70	31739	278.99	x	3.53	33973	289.00	x	6.30	34395	302.00	x	5.00	33238	315.00	x	5.70
34720	270.00	x	5.70	36094	278.99	x	3.53	36313	289.10	x	8.40	36126	302.00	x	7.00	34222	315.00	x	10.00
34028	270.00	x	6.00	31739	278.99	x	3.53	33806	289.30	x	5.70	36127	302.00	x	8.00	36144	315.12	x	6.35
	270.00	x	6.00	36095	279.18	x	2.62	34633	289.30	x	5.70	33737	303.00	x	7.00	32447	315.70	x	5.30
34028	270.00	x	6.00	32232	279.30	x	5.70	33360	289.50	x	5.00	31032	304.00	x	4.76	32417	315.70	x	5.30
34276	270.00	x	8.00	36096	279.50	x	8.40	33166	289.50	x	5.00	31311	304.00	x	6.35	36145	316.00	x	8.00
34276	270.00	x	8.00	32391	280.00	x	3.00	32267	290.00	x	3.50	34170	304.00	x	7.00	31405	316.27	x	6.99
33120	270.00	x	8.40	32391	280.00	x	3.00	33890	290.00	x	4.00	34170	304.00	x	7.00	34697	316.27	x	6.99
30732	271.00	x	3.50	36435	280.00	x	4.00	33890	290.00	x	4.00	31804	304.17	x	5.33	31848	316.87	x	6.99
33391	271.00	x	7.00	33902	280.00	x	5.00	33941	290.00	x	5.00	32771	304.17	x	5.33	31848	316.87	x	6.99
32072	271.00	x	7.00	33904	280.00	x	6.00	33941	290.00	x	5.00	31193	304.17	x	5.33	32154	317.00	x	3.00
34778	271.00	x	7.00	36097	280.00	x	6.50	36109	291.00	x	6.00	31804	304.17	x	5.33	36146	317.00	x	7.50
31165	271.90	x	5.30	33710	280.00	x	7.00	31803	291.47	x	5.33	31847	304.17	x	6.99	33970	317.00	x	9.00
30502	272.00	x	3.00	33710	280.00	x	7.00	33335	291.47	x	5.33	32478	304.17	x	6.99	36147	317.00	x	9.00
34532	272.00	x	16.00	31487	280.00	x	8.00	31803	291.47	x	5.33	34252	304.39	x	3.53	36935	317.00	x	9.50
36084	272.65	x	11.11	36474	280.00	x	9.00	31846	291.47	x	6.99	31741	304.39	x	3.53	33566	317.50	x	3.50
36085	273.00	x	5.00	36098	280.00	x	10.00	36110	291.47	x	6.99	34252	304.39	x	3.53	33495	317.50	x	6.35
36086	273.05	x	9.13	36099	280.00	x	15.00	31740	291.69	x	3.53	33639	304.39	x	3.53	32314	317.50	x	6.35
36087	274.00	x	3.40	36356	280.00	x	30.00	30765	291.69	x	3.53	31741	304.39	x	3.53	32621	317.50	x	6.99
36088	274.00	x	8.00	30960	280.50	x	2.00	31740	291.69	x	3.53	30733	304.80	x	3.50	34268	318.00	x	3.70
34318	274.20	x	5.25	34356	281.00	x	5.50	30765	291.69	x	3.53	36128	304.80	x	7.94	36148	318.00	x	6.50
34378	275.00	x	2.50	33434	281.00	x	5.50	31740	291.69	x	3.53	32868	304.80	x	9.50	36149	318.11	x	5.99
34381	275.00	x	3.00	34387	282.00	x	4.00	33940	291.75	x	2.65	34798	305.00	x	2.50	36150	318.30	x	7.00
30960	275.00	x	4.00	34387	282.00	x	4.00	36111	291.77	x	2.62	32920	305.00	x	5.00	33055	319.00	x	3.10
30960	275.00	x	4.00	36100	282.00	x	10.00	34317	292.00	x	3.00	33218	305.00	x	5.00	33055	319.00	x	3.10
32916	275.00	x	5.00	32033	283.00	x	5.00	32432	292.00	x	7.00	32239	306.00	x	3.00	34650	319.00	x	5.70
33430	275.00	x	6.00	32258	283.00	x	5.00	36112	292.10	x	3.18	33999	306.00	x	4.00	32145	319.30	x	5.70
36089	275.03	x	1.77	33486	283.00	x	5.00	33492	292.10	x	6.35	34585	306.00	x	4.00	32919	320.00	x	1.78
36864	275.50	x	7.50	33484	283.00	x	6.00	33062	294.10	x	5.70	32436	306.00	x	4.80	36376	320.00	x	3.00
36090	276.20	x	3.80	36101	283.00	x	12.00	33379	295.00	x	2.80	32942	306.00	x	4.80	36376	320.00	x	3.00
34168	277.00	x	3.17	36102	283.70	x	5.50	33621	295.00	x	5.50	32988	306.00	x	5.34	36151	320.00	x	3.50
								36113	295.00	x	6.00	34382	307.00	x	3.00	36152	320.00	x	3.50
								36114	295.00	x	7.00	34382	307.00	x	3.00	36952	320.00	x	4.00
								36115	295.00	x	7.50	34089	307.00	x	13.00	36952	320.00	x	4.00
								31488	295.00	x	8.00	36922	307.20	x	7.00		320.00	x	4.40
								36116	295.00	x	9.50	36130	307.98	x	3.53	33491	320.00	x	5.00
								36117	295.28	x	4.76	33412	308.00	x	3.50	32189	320.00	x	6.00
								32382	295.67	x	3.53	36131	308.00	x	8.00	33903	320.00	x	8.00
								36119	296.00	x	11.00	36133	310.00	x	3.00	36153	320.00	x	10.00
								36118	297.00	x	4.00	30734	310.00	x	3.50	36154	320.00	x	12.00
								36118	297.00	x	4.00	30964	310.00	x	4.00	36155	320.68	x	8.73
								33605	297.00	x	10.50	32736	310.00	x	5.00	32225	322.00	x	7.50
								31403	297.81	x	6.99	32736	310.00	x	5.00	36156	322.20	x	3.30





# Anéis



INCOVE VEDAÇÕES LTDA.

Cód.	Di	x	Esp.	Cód.	Di	x	Esp.	Cód.	Di	x	Esp.	Cód.	Di	x	Esp.
30604	322.30	x	3.30	36168	337.50	x	2.50	30967	354.00	x	4.00	31166	374.00	x	5.70
32155	322.60	x	4.80	33115	337.80	x	6.35	33791	354.00	x	8.00	31350	374.50	x	6.10
30735	323.00	x	3.50	34706	337.80	x	6.35	33972	354.50	x	8.40	33527	374.50	x	6.80
36157	323.00	x	6.00	32435	338.00	x	4.80	31806	354.97	x	5.33	33389	374.80	x	4.00
36939	323.80	x	4.00	32941	338.00	x	4.80	33350	354.97	x	5.33	30505	375.00	x	3.00
36158	323.85	x	12.70	32978	338.00	x	5.34	31806	354.97	x	5.33	36311	375.00	x	5.00
33961	325.00	x	2.00	34537	338.00	x	6.00	32576	354.97	x	6.99	36311	375.00	x	5.00
33850	325.00	x	5.00	33922	338.50	x	6.50	31851	354.97	x	6.99	34615	377.00	x	8.00
36159	325.00	x	10.00	36169	339.00	x	7.00	34488	355.00	x	3.00	33049	378.00	x	6.00
34017	325.70	x	5.30	36170	339.00	x	10.00	34385	355.00	x	3.00	31280	379.30	x	5.70
32775	326.00	x	7.50	32231	339.30	x	5.70	36176	355.00	x	4.00	32178	380.00	x	3.50
36160	327.00	x	3.00	32915	339.40	x	7.00	34433	355.00	x	5.00	36955	380.00	x	5.00
34237	327.00	x	3.10	33236	339.50	x	8.40	34433	355.00	x	5.00	33998	380.00	x	8.00
34258	328.00	x	4.00	36171	340.00	x	3.50	34457	355.00	x	6.00	34771	380.00	x	8.00
30965	328.00	x	4.00	33952	340.00	x	4.00	34457	355.00	x	6.00	34771	380.00	x	8.00
30966	328.00	x	4.00	34396	340.00	x	5.00	36177	355.00	x	9.00	31518	380.00	x	10.00
33772	328.50	x	7.94	36172	340.00	x	5.50	31743	355.19	x	3.53	36186	380.00	x	13.00
30766	329.00	x	3.53	34530	340.00	x	6.00	31743	355.19	x	3.53	31807	380.37	x	5.33
33226	329.00	x	3.53	34032	340.00	x	8.00	36325	355.19	x	3.53	32585	380.37	x	5.33
31805	329.57	x	5.33	34616	340.00	x	10.00	31743	355.19	x	3.53	31807	380.37	x	5.33
32931	329.57	x	5.33	33481	341.00	x	5.30	34306	356.50	x	8.00	31853	380.37	x	6.99
31805	329.57	x	5.33	33351	341.00	x	5.30	33517	358.00	x	5.00	36187	380.37	x	6.99
31849	329.57	x	6.99	32449	341.00	x	7.00	36178	359.00	x	4.00	31744	380.59	x	3.53
31406	329.57	x	6.99	32443	341.00	x	7.00	34426	359.30	x	5.70	36188	380.59	x	3.53
32038	329.57	x	6.99	36173	342.00	x	3.00	33971	359.50	x	8.40	31744	380.59	x	3.53
32577	329.70	x	5.33	31850	342.27	x	6.99	36179	359.56	x	12.70	32166	381.00	x	3.53
34762	329.74	x	3.53	31407	342.27	x	6.99	36180	360.00	x	3.50	30843	381.00	x	3.97
31742	329.79	x	3.53	32723	342.90	x	6.35	31345	360.00	x	6.00	34151	381.00	x	6.30
31742	329.79	x	3.53	36937	343.77	x	5.33	33458	360.00	x	7.50	36189	382.30	x	8.00
33649	329.79	x	3.53	34399	343.77	x	5.33	34726	360.00	x	7.50	33920	385.00	x	6.00
36161	329.79	x	3.53	33930	344.00	x	1.30	32313	360.00	x	8.00	33507	385.00	x	10.00
31742	329.79	x	3.53	36174	345.00	x	5.00	31194	360.30	x	5.33	32917	386.00	x	2.62
31873	330.00	x	2.40	32600	345.00	x	5.34	32167	361.95	x	3.53	31346	388.00	x	6.00
33848	330.00	x	4.00	32600	345.00	x	5.34	32410	361.95	x	5.33	32037	388.00	x	9.00
36162	330.00	x	5.00	33498	345.00	x	6.00	32036	363.00	x	5.00	30736	390.00	x	3.50
32748	330.00	x	6.00	36175	346.08	x	3.18	32036	363.00	x	5.00	36394	390.00	x	4.00
34171	330.00	x	8.00	32434	347.00	x	3.50	33907	364.40	x	6.40	33793	390.00	x	5.00
34608	330.00	x	8.00	34006	347.00	x	7.00	36181	365.00	x	3.50	33793	390.00	x	5.00
33708	330.00	x	10.00	33964	348.00	x	4.00	32866	365.00	x	5.00	33497	390.00	x	6.00
36163	330.00	x	13.30	33816	348.00	x	5.70	34298	365.00	x	8.00	36190	390.00	x	8.50
32297	330.20	x	4.76	33816	348.00	x	5.70	32937	365.00	x	10.00	36191	391.50	x	5.50
32722	330.20	x	6.35	33446	348.00	x	6.00	32937	365.00	x	10.00	30506	392.00	x	3.00
32980	332.00	x	5.34	34316	349.20	x	5.25	36182	366.00	x	2.50	33183	393.00	x	6.00
36164	332.00	x	6.00	33515	350.00	x	3.50	33771	367.00	x	3.50	31444	393.00	x	7.00
32981	332.00	x	7.00	34212	350.00	x	5.00	36414	367.00	x	4.80	32123	393.00	x	9.00
36946	332.00	x	8.00	34212	350.00	x	5.00	36475	367.00	x	5.00	31854	393.07	x	6.99
33236	333.00	x	8.40	36176	350.00	x	5.50	36183	367.00	x	6.00	32301	393.07	x	6.99
34130	334.00	x	8.00	31344	350.00	x	6.00	33545	367.54	x	5.33	34601	393.07	x	6.99
34396	335.00	x	5.00	33837	350.00	x	7.00	33129	367.54	x	5.33	31854	393.07	x	6.99
33912	335.00	x	6.35	34099	350.00	x	8.00	36184	367.67	x	5.33	33494	393.70	x	6.35
36165	335.00	x	9.00	33546	350.00	x	9.00	34340	367.67	x	6.99	32256	394.00	x	4.00
36166	336.00	x	6.00	33851	350.00	x	10.00	31852	367.67	x	6.99	34469	394.00	x	4.00
34239	336.50	x	3.50	30504	351.00	x	3.00	34340	367.67	x	6.99	36192	395.00	x	4.00
36167	337.00	x	3.50	33653	351.00	x	4.00	36182	368.00	x	2.50	34124	396.46	x	3.53
30022	337.00	x	5.00	33900	352.00	x	8.40	36182	368.00	x	2.50	36305	398.00	x	8.00
								33830	368.00	x	10.00	36305	398.00	x	8.00
								33019	368.30	x	6.35	33747	398.40	x	7.00
								32775	368.30	x	6.35	33747	398.40	x	7.00
								36185	369.00	x	3.20	32158	399.30	x	5.70
								30830	370.00	x	3.80	32158	399.30	x	5.70
								36357	370.00	x	4.00	33660	400.00	x	3.53
								32445	370.70	x	5.30	33514	400.00	x	3.53
								34605	370.70	x	5.30	32256	400.00	x	4.00
								32442	371.00	x	7.00	32256	400.00	x	4.00
								33307	371.00	x	7.00	33511	400.00	x	5.00
								33794	373.00	x	7.00	36193	400.00	x	5.30
								33794	373.00	x	7.00	33299	400.00	x	5.33
												32437	421.00	x	6.00
												32462	421.00	x	7.00
												32524	421.00	x	7.00
												31512	421.50	x	9.50
												33579	424.00	x	5.00
												32918	425.00	x	2.62
												36203	425.00	x	4.00
												36203	425.00	x	4.00
												32601	425.00	x	5.34
												32677	426.00	x	7.00
												33050	428.00	x	3.50
												31351	428.50	x	6.10





# Anéis



INCOVE VEDAÇÕES LTDA.

Cód.	Di	x	Esp.	Cód.	Di	x	Esp.	Cód.	Di	x	Esp.	Cód.	Di	x	Esp.
36205	429.26	x	7.62	33709	450.00	x	8.00	34553	489.00	x	6.00	31506	540.00	x	9.00
32774	430.00	x	3.53	33921	454.00	x	5.40	34442	489.30	x	5.70	31506	540.00	x	9.00
34467	430.00	x	3.53	31747	456.06	x	3.53	34404	489.30	x	5.70	36249	542.50	x	5.70
36443	430.00	x	4.00	34007	456.06	x	3.53	34388	489.80	x	4.00	36250	545.00	x	3.00
34111	430.00	x	8.00	31810	456.06	x	5.33	36226	490.00	x	3.00	33475	545.20	x	6.00
33838	430.00	x	10.00	31810	456.06	x	5.33	32392	490.00	x	5.00	36251	545.70	x	6.99
31746	430.66	x	3.53	31859	456.06	x	6.99	36227	490.70	x	6.99	36252	546.46	x	5.33
36206	430.66	x	3.53	36215	456.06	x	6.99	33181	493.00	x	3.50	34397	548.00	x	5.00
31809	430.66	x	5.33	36216	459.00	x	6.00	31877	494.00	x	3.00	36315	548.00	x	5.70
32591	430.66	x	5.33	33666	459.30	x	5.70	36228	494.03	x	13.97	33959	549.28	x	5.33
31809	430.66	x	5.33	33203	459.30	x	5.70	31862	494.16	x	6.99	34392	550.00	x	4.90
31409	430.66	x	6.99	36825	460.00	x	3.00	33024	494.16	x	6.99	33124	553.20	x	8.40
31409	430.66	x	6.99	33512	460.00	x	3.50	36229	494.66	x	5.33	33596	553.20	x	8.40
32687	431.00	x	4.00	33260	460.00	x	3.50	3620	495.00	x	8.00	32753	555.00	x	5.50
31033	431.80	x	4.76	36302	460.00	x	4.00	36229	496.80	x	3.50	34534	557.60	x	5.33
31033	431.80	x	4.76	36302	460.00	x	4.00	36230	498.00	x	7.00	31814	557.61	x	5.33
33977	431.80	x	6.00	36217	460.00	x	6.50	30968	498.50	x	4.00	31411	557.66	x	6.99
34837	431.80	x	7.40	32754	460.00	x	8.00	34241	499.30	x	5.70	31411	557.66	x	6.99
34413	433.10	x	7.00	34523	464.00	x	3.00	34241	500.00	x	5.60	34421	558.80	x	4.00
33849	433.50	x	5.00	33933	464.50	x	8.40	36232	500.00	x	6.00	36253	560.00	x	5.70
32040	435.00	x	4.00	36218	465.00	x	9.00	31353	500.00	x	6.20	33969	560.00	x	8.00
33448	435.00	x	4.00	36219	466.00	x	8.00	32685	500.00	x	8.00	36254	564.00	x	3.00
33849	435.00	x	5.00	31348	468.00	x	6.00	31494	500.00	x	8.50	33576	567.00	x	6.99
31347	438.00	x	6.00	31860	468.76	x	6.99	31505	502.00	x	9.00	36255	569.91	x	9.77
34313	439.00	x	5.30	36220	468.76	x	6.99	36233	504.50	x	2.50	36905	570.00	x	5.00
36207	439.00	x	6.00	33023	469.00	x	3.50	36234	506.40	x	8.00	33575	570.00	x	5.33
34420	439.00	x	7.00	36221	470.00	x	2.50	31196	506.81	x	5.33	32952	570.00	x	5.70
34423	439.30	x	5.70	36222	470.00	x	3.20	31812	506.81	x	5.33	32952	570.00	x	5.70
36208	440.00	x	4.00	36223	470.00	x	4.00	31196	506.81	x	5.33	34223	571.50	x	9.53
33499	440.00	x	5.50	32596	470.00	x	10.00	36235	506.81	x	6.99	34223	571.50	x	9.53
34204	440.00	x	9.50	36437	470.00	x	10.00	31863	506.86	x	6.99	34389	573.80	x	4.00
36209	441.00	x	8.00	31534	472.00	x	20.00	34144	507.00	x	8.70	34405	580.00	x	5.70
31138	442.00	x	5.00	31445	472.50	x	7.00	30129	508.00	x	10.00	36256	580.00	x	9.00
34048	442.00	x	12.00	33031	473.00	x	3.50	36236	508.50	x	8.60	34209	580.00	x	13.40
31858	443.36	x	6.99	32440	473.70	x	5.30	32772	509.00	x	10.00	31815	582.68	x	5.33
36210	443.36	x	6.99	32433	473.70	x	5.30	36310	510.00	x	3.00	33390	582.68	x	5.33
32502	444.00	x	8.00	34110	475.00	x	12.70	36237	510.00	x	3.50	31866	582.68	x	6.99
31489	444.00	x	8.00	33516	477.30	x	6.35	36951	510.00	x	5.00	33310	582.68	x	6.99
32502	444.00	x	8.00	36224	477.50	x	7.93	32970	510.00	x	5.70	33137	589.00	x	7.00
31489	444.00	x	8.00	36225	478.00	x	12.00	36238	517.00	x	8.00	32599	595.00	x	2.50
32743	444.50	x	6.35	36895	478.30	x	8.40	36239	518.00	x	6.00	36358	595.00	x	6.00
36211	444.50	x	7.62	32128	479.30	x	5.70	36240	518.00	x	7.40	34538	596.00	x	14.50
34785	445.00	x	5.00	34403	479.30	x	5.70	33659	520.00	x	6.99	34133	596.90	x	5.30
34785	445.00	x	5.00	36823	479.67	x	8.40	31870	520.00	x	9.00	31490	598.00	x	8.00
32953	445.00	x	5.33	34562	480.00	x	0.00	36241	520.00	x	10.00	33206	600.00	x	5.00
34085	445.00	x	6.00	36326	480.00	x	4.00	36242	520.00	x	11.80	36257	600.00	x	6.00
34085	445.00	x	6.00	36326	480.00	x	4.00	36243	520.70	x	6.35	33271	600.00	x	7.00
36212	446.00	x	4.60	33767	480.00	x	10.00	34414	522.60	x	7.00	34137	600.00	x	10.00
34155	446.00	x	7.00	31811	481.14	x	5.33	36244	525.00	x	4.76	36258	605.00	x	25.40
33305	447.00	x	4.00	31811	481.41	x	5.33	36245	526.00	x	7.00	31816	608.08	x	5.33
33953	450.00	x	3.00	31811	481.41	x	5.33	36824	530.00	x	4.00	36259	608.08	x	5.33
36213	450.00	x	4.50	31410	481.46	x	6.99	36304	530.00	x	5.00	31867	608.08	x	6.99
34652	450.00	x	5.00	31410	481.46	x	6.99	36304	530.00	x	5.00	33311	608.08	x	6.99
34652	450.00	x	5.00	33051	483.00	x	3.50	32394	530.00	x	6.00	33311	608.08	x	6.99
36214	450.00	x	6.00	34427	488.30	x	5.70	31100	530.00	x	9.00	32950	609.60	x	5.33
31813	532.21	x	5.33	34763	609.60	x	5.33	34763	609.60	x	5.33	36902	910.00	x	10.00
31813	532.21	x	5.33	36441	610.00	x	6.35	36441	610.00	x	6.35	36280	911.59	x	27.78
36246	532.21	x	6.99	33840	619.30	x	5.70	33840	619.30	x	5.70	36281	924.68	x	19.05
31864	532.26	x	6.99	34406	619.30	x	5.70	34406	619.30	x	5.70	34215	927.10	x	6.99
36314	534.00	x	5.70	36260	619.60	x	8.00	36260	619.60	x	8.00	36917	939.80	x	6.35
34853	535.00	x	4.00	36450	620.00	x	5.00	36450	620.00	x	5.00	36826	940.00	x	5.00
36411	535.00	x	5.00	36261	620.00	x	6.00	36261	620.00	x	6.00	36308	944.00	x	6.35
36247	537.00	x	4.80	32951	620.00	x	8.40	32951	620.00	x	8.40	36355	960.00	x	5.00
34217	539.00	x	6.00	33273	625.00	x	7.00	33273	625.00	x	7.00	36282	984.25	x	6.99
36303	540.00	x	4.00	36262	629.00	x	12.00	36262	629.00	x	12.00	36818	990.00	x	6.00
36303	540.00	x	4.00	33665	629.30	x	5.70	33665	629.30	x	5.70	36815	1020.00	x	5.00
36248	540.00	x	8.00	33665	629.30	x	5.70	33665	629.30	x	5.70	36283	1023.00	x	6.99





# Anéis



INCOVE VEDAÇÕES LTDA.

Cód.	Di	x	Esp.	Cód.	Di	x	Esp.	Cód.	Di	x	Esp.	Cód.	Di	x	Esp.
36284	1028.70	x	6.99	34407	1080.00	x	6.00	36817	1110.00	x	5.00	36388	1295.00	x	3.53
36816	1030.00	x	5.00	36871	1080.00	x	10.00	36287	1146.17	x	9.77	36916	1384.30	x	6.35
36285	1041.40	x	6.99	36286	1090.00	x	5.00	36288	1168.40	x	12.70	34408	1518.00	x	6.35
36903	1060.00	x	5.00	36915	1092.20	x	6.35	36467	1200.00	x	6.00	34409	1540.00	x	6.35
34398	1070.00	x	5.00	34418	1100.00	x	10.00	34417	1255.00	x	9.00	36812	1655.00	x	7.00









INCOVE VEDAÇÕES LTDA.

# ARruelas

Código	Di x	De x	Ha1	Código	Di x	De x	Ha1	Código	Di x	De x	Ha1
F15164	0.00 x	40.00 x	0.50	00049	5.50 x	9.50 x	1.20	00460	7.20 x	12.00 x	1.50
00779	1.60 x	8.60 x	1.10	00574	5.50 x	10.00 x	1.50	00433	7.26 x	10.50 x	2.10
01026	2.00 x	6.60 x	0.50	00127	5.50 x	11.00 x	1.60	00312	7.30 x	15.50 x	3.30
01278	2.00 x	6.90 x	1.68	01381	5.50 x	20.00 x	1.00	00032	7.30 x	15.50 x	3.30
01027	2.38 x	10.80 x	0.50	00333	5.50 x	23.00 x	10.00	00641	7.30 x	19.70 x	5.30
00843	3.00 x	5.00 x	2.00	00440	5.56 x	19.05 x	3.17	00120	7.30 x	33.90 x	1.10
00679	3.00 x	6.20 x	1.90	01587	5.60 x	11.00 x	2.00	01733	7.50 x	14.50 x	2.00
01412	3.00 x	8.00 x	4.00	00797	5.70 x	10.70 x	1.50	00923	7.50 x	14.50 x	4.60
01204	3.00 x	44.00 x	3.00	01602	5.70 x	17.00 x	3.00	00414	7.50 x	17.00 x	6.35
USIN	3.00 x	94.40 x	1.50	USIN	5.90 x	7.60 x	0.20	01600	7.50 x	24.00 x	2.50
00592	3.10 x	8.86 x	1.30	00158	5.90 x	11.00 x	3.40	00118	7.50 x	33.50 x	1.50
01014	3.17 x	6.35 x	0.50	USIN	6.00 x	9.00 x	1.50	01000	7.50 x	64.50 x	1.50
01448	3.50 x	7.00 x	0.80	00363	6.00 x	10.00 x	6.35	00814	7.60 x	10.80 x	1.80
01440	3.50 x	7.00 x	0.80	USIN	6.00 x	11.00 x	1.50	00160	7.70 x	28.00 x	3.20
00144	3.50 x	8.00 x	2.00	01264	6.00 x	11.50 x	6.00	00078	7.80 x	12.70 x	1.20
00538	3.65 x	6.55 x	2.05	01547	6.00 x	12.00 x	2.00	00539	7.80 x	25.80 x	3.20
USIN	4.00 x	5.00 x	2.00	00504	6.00 x	12.50 x	6.00	01033	7.93 x	11.11 x	1.58
01651	4.00 x	7.00 x	0.50	01875	6.00 x	12.90 x	4.10	00241	8.00 x	11.00 x	2.50
00863	4.00 x	7.00 x	1.20	00600	6.00 x	14.00 x	4.00	00476	8.00 x	11.10 x	1.50
01787	4.00 x	7.00 x	1.20	01248	6.00 x	14.80 x	4.00	00549	8.00 x	11.70 x	1.90
00505	4.00 x	7.00 x	3.00	00979	6.00 x	15.50 x	2.00	01727	8.00 x	12.00 x	1.70
01416	4.00 x	7.50 x	0.80	01934	6.00 x	17.00 x	18.50	00278	8.00 x	12.00 x	2.50
01860	4.00 x	7.50 x	3.20	00617	6.00 x	18.00 x	5.00	00279	8.00 x	12.00 x	2.50
01991	4.00 x	7.60 x	1.00	00985	6.00 x	22.00 x	15.00	00529	8.00 x	14.00 x	5.00
01629	4.00 x	16.00 x	4.00	00639	6.00 x	23.00 x	3.00	00938	8.00 x	14.00 x	5.00
00912	4.00 x	16.50 x	1.20	01116	6.00 x	40.00 x	1.00	01805	8.00 x	15.00 x	2.00
00477	4.20 x	6.90 x	2.10	01954	6.00 x	152.00 x	1.00	01505	8.00 x	16.00 x	3.00
00565	4.20 x	7.00 x	2.00	01940	6.00 x	152.00 x	1.00	02008	8.00 x	16.00 x	5.00
00269	4.30 x	20.20 x	3.30	01371	6.07 x	9.43 x	1.68	00175	8.00 x	17.50 x	2.50
01959	4.50 x	18.00 x	3.17	00975	6.10 x	10.50 x	3.00	00813	8.00 x	18.00 x	1.80
00072	4.50 x	27.00 x	1.00	00599	6.20 x	18.50 x	1.70	00552	8.00 x	19.30 x	2.00
00338	4.50 x	75.00 x	15.00	01358	6.30 x	10.80 x	3.80	00820	8.00 x	22.00 x	6.50
00047	4.60 x	7.90 x	2.00	00349	6.30 x	12.00 x	3.00	01430	8.00 x	89.00 x	1.50
00573	4.60 x	9.00 x	1.40	00424	6.34 x	11.11 x	3.17	01904	8.00 x	108.50 x	0.55
00927	4.70 x	51.30 x	4.60	01034	6.35 x	9.52 x	1.58	00933	8.20 x	10.90 x	1.10
00329	4.76 x	14.29 x	3.17	01550	6.35 x	12.40 x	1.10	00048	8.20 x	16.50 x	1.70
00425	4.76 x	39.69 x	4.76	01426	6.35 x	12.70 x	4.76	00048	8.20 x	16.50 x	1.70
00747	4.80 x	9.30 x	2.00	01470	6.35 x	14.00 x	9.00	00240	8.30 x	10.80 x	1.20
00431	4.84 x	8.00 x	2.14	01254	6.35 x	18.00 x	2.00	00501	8.30 x	11.01 x	1.30
00928	5.00 x	8.00 x	3.00	00076	6.35 x	76.20 x	4.37	00126	8.50 x	15.00 x	4.70
01445	5.00 x	9.00 x	4.20	00194	6.40 x	10.40 x	2.00	00741	8.50 x	16.00 x	1.50
01623	5.00 x	9.50 x	2.00	00517	6.40 x	14.60 x	3.50	00672	8.50 x	18.50 x	1.70
01902	5.00 x	9.70 x	2.92	00932	6.50 x	9.50 x	1.10	01418	8.60 x	17.60 x	12.70
00571	5.00 x	10.00 x	1.50	01807	6.50 x	12.10 x	7.30	00167	8.70 x	23.80 x	4.00
01921	5.00 x	10.00 x	4.00	00862	6.50 x	16.00 x	2.00	00622	8.80 x	17.20 x	2.00
01382	5.00 x	10.50 x	1.80	01622	6.50 x	17.50 x	1.50	00577	9.00 x	13.00 x	3.00
01995	5.00 x	11.00 x	2.20	01115	6.50 x	90.50 x	1.30	00108	9.00 x	13.00 x	4.30
00678	5.00 x	12.00 x	2.20	00703	6.60 x	10.92 x	3.56	01003	9.00 x	14.00 x	2.50
01608	5.00 x	12.00 x	5.00	00003	6.60 x	12.70 x	4.10	00835	9.00 x	15.00 x	1.50
01906	5.00 x	12.40 x	2.40	00266	6.70 x	11.10 x	3.57	01420	9.00 x	15.00 x	1.50
00838	5.00 x	15.00 x	8.00	00676	6.80 x	9.50 x	1.40	01211	9.00 x	15.00 x	2.00
00726	5.00 x	20.00 x	2.00	00648	6.80 x	33.00 x	1.90	00776	9.00 x	15.80 x	1.50
00960	5.00 x	49.00 x	2.00	01375	6.90 x	10.90 x	1.68	01402	9.00 x	15.85 x	1.00
00725	5.16 x	17.46 x	3.57	USIN	7.00 x	10.00 x	0.50	01275	9.00 x	16.00 x	4.00
00808	5.30 x	17.30 x	3.20	00665	7.00 x	12.70 x	2.00	01290	9.00 x	17.00 x	2.00
00358	7.00 x	13.00 x	1.00	01437	9.00 x	17.00 x	2.30	01437	9.00 x	17.00 x	2.30
01253	7.00 x	14.00 x	2.40	00823	9.00 x	17.00 x	10.00	00422	9.00 x	19.00 x	1.50
00085	7.00 x	16.00 x	2.00	00422	9.00 x	19.00 x	1.50	00452	9.00 x	20.00 x	2.00
00095	7.00 x	16.50 x	2.00	00095	7.00 x	16.50 x	2.00	01379	9.00 x	22.00 x	4.00
01690	7.00 x	16.50 x	2.00	00572	7.00 x	19.00 x	5.00	01201	9.00 x	23.00 x	3.00
00572	7.00 x	19.00 x	5.00	00455	7.00 x	20.00 x	4.00	00081	9.00 x	23.00 x	9.00
00455	7.00 x	20.00 x	4.00	00515	7.00 x	21.80 x	10.00	01889	9.00 x	23.30 x	2.00
00515	7.00 x	21.80 x	10.00	01002	7.00 x	42.00 x	19.00	01803	9.00 x	24.50 x	2.00
01002	7.00 x	42.00 x	19.00	00583	7.12 x	41.44 x	6.35	01955	9.00 x	27.50 x	1.50
00583	7.12 x	41.44 x	6.35	01133	7.14 x	15.87 x	3.17	01955	9.00 x	27.50 x	1.50
01133	7.14 x	15.87 x	3.17	01843	7.20 x	10.60 x	1.80	01931	9.00 x	28.00 x	1.50
01843	7.20 x	10.60 x	1.80								

				INCOVE VEDAÇÕES LTDA.								
Código	Di x	De x	Ha1	Código	Di x	De x	Ha1	Código	Di x	De x	Ha1	
00860	9.00 x	28.00 x	7.00	00037	10.50 x	16.20 x	1.00	USIN	13.00 x	16.00 x	0.50	
01879	9.00 x	33.00 x	5.00	00937	10.50 x	17.00 x	5.00	01006	13.00 x	16.00 x	2.00	
01804	9.00 x	34.00 x	15.00	00562	10.50 x	17.50 x	3.00	01901	13.00 x	17.00 x	1.50	
01798	9.10 x	12.50 x	1.70	00514	10.50 x	20.50 x	3.20	00931	13.00 x	17.20 x	1.30	
00257	9.10 x	12.80 x	1.20	00334	10.50 x	21.00 x	2.00	00812	13.00 x	18.00 x	2.50	
01424	9.20 x	16.00 x	0.70	01844	10.50 x	29.00 x	4.00	00801	13.00 x	19.00 x	1.20	
USIN	9.30 x	14.50 x	6.10	01802	10.50 x	51.00 x	2.00	00051	13.00 x	19.00 x	4.00	
01975	9.30 x	14.50 x	6.10	01941	10.80 x	22.00 x	3.80	01953	13.00 x	20.00 x	2.30	
00242	9.30 x	20.00 x	2.00	00699	11.00 x	15.00 x	2.00	00766	13.00 x	20.00 x	6.00	
00313	9.30 x	25.40 x	1.70	01698	11.00 x	16.00 x	1.70	00337	13.00 x	25.00 x	5.00	
00065	9.40 x	21.00 x	3.60	01255	11.00 x	19.00 x	1.20	00134	13.00 x	25.00 x	6.00	
01662	9.50 x	12.50 x	1.80	01951	11.00 x	21.70 x	3.80	00432	13.00 x	25.40 x	3.00	
00028	9.50 x	12.80 x	2.00	USIN	11.00 x	25.00 x	4.00	00468	13.00 x	26.00 x	6.00	
01577	9.50 x	14.00 x	10.00	01958	11.00 x	25.40 x	3.17	01739	13.00 x	31.00 x	2.50	
00738	9.50 x	14.50 x	1.00	00224	11.00 x	25.40 x	4.60	01096	13.00 x	34.70 x	4.60	
00810	9.50 x	16.50 x	5.00	00176	11.00 x	30.80 x	1.90	01742	13.15 x	15.55 x	1.20	
00383	9.50 x	18.50 x	1.10	01905	11.00 x	32.00 x	4.00	01742	13.15 x	15.55 x	1.20	
01578	9.50 x	20.00 x	6.00	01274	11.00 x	34.00 x	3.18	00351	13.20 x	15.80 x	1.40	
00084	9.50 x	21.00 x	3.50	00210	11.11 x	25.40 x	3.97	01159	13.20 x	20.80 x	2.00	
01930	9.50 x	25.00 x	1.50	00230	11.20 x	19.00 x	3.20	01531	13.50 x	17.50 x	3.00	
01930	9.50 x	25.00 x	1.50	00786	11.20 x	20.00 x	20.20	01723	13.50 x	18.50 x	0.55	
USIN	9.50 x	35.20 x	4.50	01494	11.21 x	12.00 x	1.90	00807	13.50 x	23.50 x	3.00	
01032	9.52 x	12.70 x	1.58	01163	11.40 x	14.00 x	1.20	01870	13.50 x	24.50 x	4.00	
01032	9.52 x	12.70 x	1.58	01679	11.50 x	15.50 x	1.30	01210	13.50 x	40.20 x	6.00	
00113	9.52 x	14.29 x	3.57	01388	11.50 x	15.50 x	15.00	00021	13.70 x	17.20 x	4.20	
USIN	9.52 x	14.68 x	1.70	00258	11.50 x	16.10 x	3.30	00458	13.70 x	20.60 x	2.00	
00157	9.52 x	17.46 x	3.97	01678	11.50 x	16.50 x	1.30	00666	13.70 x	25.00 x	3.30	
00131	9.52 x	34.92 x	3.70	00221	11.50 x	22.00 x	6.00	01575	13.80 x	19.80 x	1.20	
00934	9.90 x	12.50 x	1.10	01421	11.60 x	16.10 x	1.30	00815	13.80 x	22.20 x	2.00	
01162	9.90 x	12.70 x	1.27	00516	11.70 x	25.00 x	3.50	00983	13.80 x	31.40 x	2.60	
01378	9.90 x	20.00 x	6.00	00684	12.00 x	16.00 x	3.00	00649	13.90 x	19.30 x	2.70	
01374	10.00 x	13.00 x	1.50	00655	12.00 x	17.00 x	2.50	USIN	14.00 x	16.00 x	3.00	
00868	10.00 x	14.00 x	2.00	01657	12.00 x	17.00 x	7.00	00226	14.00 x	17.00 x	2.00	
01415	10.00 x	14.00 x	7.00	00435	12.00 x	17.50 x	2.40	01697	14.00 x	18.00 x	1.80	
_____	10.00 x	15.00 x	1.50	00702	12.00 x	17.90 x	2.70	00143	14.00 x	18.00 x	5.00	
00535	10.00 x	15.00 x	3.00	01355	12.00 x	18.00 x	2.00	01008	14.00 x	18.20 x	3.00	
00816	10.00 x	16.00 x	2.00	01667	12.00 x	18.00 x	2.70	00989	14.00 x	19.00 x	5.00	
01952	10.00 x	17.00 x	2.50	00292	12.00 x	19.00 x	1.60	00674	14.00 x	19.50 x	2.60	
01753	10.00 x	17.20 x	3.00	00677	12.00 x	19.00 x	1.80	00248	14.00 x	20.50 x	1.80	
00086	10.00 x	17.90 x	3.70	00914	12.00 x	19.00 x	4.00	00344	14.00 x	22.40 x	3.10	
00551	10.00 x	19.30 x	2.00	USIN	12.00 x	19.10 x	3.50	00872	14.00 x	24.00 x	4.00	
00882	10.00 x	20.00 x	6.00	02016	12.00 x	19.40 x	1.50	00031	14.00 x	24.00 x	5.00	
USIN	10.00 x	20.00 x	6.50	00743	12.00 x	21.00 x	1.50	01053	14.00 x	24.00 x	6.50	
01427	10.00 x	22.50 x	4.50	00402	12.00 x	22.00 x	4.00	01338	14.00 x	26.00 x	2.50	
00540	10.00 x	25.00 x	3.00	01158	12.00 x	22.00 x	11.00	00465	14.00 x	27.00 x	12.70	
USIN	10.00 x	27.50 x	5.00	00570	12.00 x	31.00 x	6.00	01925	14.00 x	27.50 x	2.00	
00594	10.00 x	28.00 x	10.00	01932	12.00 x	32.00 x	1.50	00421	14.00 x	28.00 x	2.00	
00861	10.00 x	30.00 x	6.30	01377	12.35 x	17.40 x	2.50	00596	14.00 x	28.00 x	3.20	
00877	10.00 x	40.00 x	14.00	01331	12.37 x	17.40 x	2.51	00406	14.00 x	28.00 x	8.00	
01927	10.30 x	45.00 x	10.00	01493	12.50 x	16.00 x	2.20	01957	14.00 x	31.00 x	3.17	
01927	10.30 x	45.00 x	10.00	00312	12.50 x	19.50 x	2.50	00965	14.00 x	32.00 x	15.00	
00802	10.40 x	16.00 x	1.20	01928	12.50 x	20.00 x	3.00	01453	14.00 x	38.00 x	1.00	
01646	10.50 x	14.20 x	1.80	00566	12.50 x	24.00 x	1.40	00717	14.00 x	38.00 x	3.00	
USIN	10.50 x	16.00 x	0.60	01563	12.50 x	24.00 x	5.00	01876	14.00 x	76.50 x	8.90	
				00737	12.50 x	27.00 x	9.50	00171	14.20 x	18.40 x	4.20	
				01979	12.50 x	45.00 x	10.00	01285	14.20 x	18.50 x	1.30	
				01998	12.60 x	15.80 x	2.00	01349	14.28 x	19.05 x	3.17	
				00388	12.60 x	23.00 x	2.70	00345	14.29 x	30.16 x	3.17	
				00253	12.70 x	15.87 x	1.59	00553	14.30 x	19.00 x	1.50	
				01031	12.70 x	17.46 x	2.38	01783	14.30 x	21.20 x	1.20	
				01460	12.70 x	19.05 x	3.17	01783	14.30 x	21.20 x	1.20	
				00576	12.70 x	19.05 x	7.94	01127	14.30 x	23.40 x	40.00	
				00177	12.70 x	20.64 x	4.30	00291	14.30 x	28.50 x	2.00	
				00582	12.70 x	26.64 x	6.35	01022	14.30 x	35.70 x	6.00	
				01857	12.70 x	28.58 x	3.17	00350	14.50 x	17.10 x	1.40	
				00274	12.70 x	31.50 x	6.00	00243	14.50 x	20.20 x	1.60	
				00590	12.80 x	16.00 x	1.00	01871	14.70 x	32.00 x	1.20	



								INCOLVE VEDAÇÕES LTDA.			
Código	Di x	De x	Ha1	Código	Di x	De x	Ha1	Código	Di x	De x	Ha1
01731	14.80 x	19.00 x	3.17	01541	16.00 x	31.00 x	8.20	USIN	19.05 x	31.75 x	7.94
01286	14.80 x	21.00 x	1.30	USIN	16.00 x	32.00 x	6.70	01929	19.05 x	32.00 x	2.10
00518	14.80 x	26.80 x	3.00	00469	16.00 x	33.00 x	9.50	00685	19.05 x	38.10 x	9.52
	14.90 x	2.90 x	2.10	01454	16.00 x	33.90 x	8.00	01074	19.05 x	101.60 x	7.94
00956	14.90 x	19.70 x	0.50	00962	16.00 x	37.50 x	8.00	USIN	19.30 x	28.00 x	1.50
USIN	15.00 x	17.00 x	0.70	01066	16.00 x	42.70 x	3.25	USIN	19.70 x	25.40 x	1.20
00550	15.00 x	20.00 x	2.50	01431	16.00 x	82.80 x	1.50	01344	19.70 x	27.00 x	1.00
00536	15.00 x	20.00 x	3.00	00670	16.00 x	160.00 x	15.00	00170	19.80 x	26.80 x	2.50
00686	15.00 x	22.00 x	2.50	01124	16.40 x	20.00 x	1.80	00484	19.80 x	26.80 x	4.00
USIN	15.00 x	25.00 x	3.00	00027	16.50 x	23.00 x	1.00		19.90 x	24.00 x	1.00
USIN	15.00 x	26.00 x	5.00	01746	16.50 x	23.50 x	4.00	01256	20.00 x	21.00 x	3.00
01831	15.00 x	26.00 x	6.50	00512	16.50 x	27.50 x	7.00	01492	20.00 x	23.50 x	1.70
00061	15.00 x	35.00 x	5.00	01111	16.50 x	35.50 x	2.95	01492	20.00 x	23.50 x	1.70
01579	15.30 x	19.30 x	1.30	00179	16.60 x	23.60 x	4.30	1985	20.00 x	24.00 x	1.00
01722	15.30 x	19.30 x	2.00	00770	16.80 x	29.60 x	2.40	01753	20.00 x	24.00 x	2.00
01799	15.40 x	18.70 x	1.50	USIN	17.00 x	21.00 x	1.30	01688	20.00 x	25.00 x	1.50
USIN	15.50 x	18.90 x	2.90	00239	17.00 x	21.20 x	1.00	00541	20.00 x	25.00 x	3.00
00911	15.50 x	22.00 x	8.00	01702	17.00 x	22.00 x	2.50	00315	20.00 x	25.50 x	2.40
00234	15.50 x	22.50 x	4.50	00548	17.00 x	22.00 x	4.00	USIN	20.00 x	26.00 x	2.00
01969	15.60 x	22.80 x	2.30	USIN	17.00 x	23.00 x	2.00	00530	20.00 x	26.00 x	2.60
00245	15.80 x	20.00 x	1.00	00004	17.00 x	24.00 x	3.50	00944	20.00 x	27.00 x	1.70
01939	15.80 x	21.80 x	8.50	01640	17.00 x	27.00 x	2.70	00874	20.00 x	28.00 x	4.00
01350	15.80 x	22.50 x	3.50	CORT	17.00 x	28.00 x	3.00	00390	20.00 x	28.00 x	7.00
00215	15.85 x	22.50 x	5.40	00964	17.00 x	30.50 x	15.00	00166	20.00 x	30.00 x	3.00
01206	15.87 x	20.80 x	2.80	00043	17.00 x	31.70 x	8.00	00410	20.00 x	30.00 x	6.50
00561	15.87 x	22.22 x	4.00	00542	17.00 x	40.00 x	1.60	01757	20.00 x	31.50 x	10.00
00297	15.87 x	22.22 x	4.76	01672	17.30 x	22.35 x	1.40	01457	20.00 x	33.00 x	1.50
00155	15.87 x	22.22 x	4.76	01777	17.50 x	21.20 x	1.32	01075	20.00 x	35.00 x	4.00
00953	15.87 x	23.50 x	4.00	00488	17.50 x	25.40 x	5.00	00485	20.00 x	36.00 x	10.00
00252	15.87 x	34.92 x	6.35	00488	17.50 x	25.40 x	5.00	00389	20.00 x	42.00 x	4.00
00227	15.87 x	34.92 x	7.94	01110	17.50 x	35.00 x	7.00	01881	20.00 x	45.50 x	4.50
00580	15.87 x	38.10 x	3.17	01839	17.60 x	28.40 x	3.40	01822	20.00 x	46.00 x	4.50
00382	15.87 x	47.62 x	6.35	USIN	17.70 x	20.70 x	0.80	01880	20.00 x	60.00 x	7.00
01004	16.00 x	19.00 x	2.00	USIN	17.80 x	22.22 x	1.30	01471	20.00 x	80.00 x	0.40
01004	16.00 x	19.00 x	2.00	01644	18.00 x	22.00 x	1.80	01908	20.00 x	100.00 x	3.00
01004	16.00 x	19.00 x	2.00	01644	18.00 x	22.00 x	1.80	01384	20.20 x	26.80 x	3.40
01641	16.00 x	19.20 x	1.50	USIN	18.00 x	22.25 x	3.00	00768	20.24 x	23.02 x	1.50
00156	16.00 x	20.00 x	2.50	00489	18.00 x	24.00 x	1.50	00856	20.30 x	25.00 x	1.00
01170	16.00 x	20.60 x	1.50	00830	18.00 x	29.00 x	3.00	USIN	20.40 x	24.40 x	5.00
01347	16.00 x	21.00 x	6.50	01178	18.00 x	29.00 x	8.00	00647	20.50 x	29.50 x	4.00
01347	16.00 x	21.00 x	6.50	00466	18.00 x	31.00 x	12.70	01479	20.60 x	27.00 x	3.80
01346	16.00 x	21.40 x	1.60	00463	18.00 x	35.00 x	9.00	00268	20.62 x	28.57 x	3.17
01054	16.00 x	21.50 x	8.00	00079	18.00 x	38.00 x	3.17	00077	20.64 x	33.34 x	3.97
00057	16.00 x	22.00 x	1.50	00165	18.00 x	38.00 x	4.75	01262	20.90 x	29.90 x	4.00
01997	16.00 x	23.00 x	4.20	01400	18.10 x	23.90 x	1.50	01620	21.00 x	25.00 x	1.00
02015	16.00 x	23.40 x	1.50	00978	18.50 x	22.00 x	1.60	USIN	21.00 x	27.00 x	1.20
01012	16.00 x	23.50 x	3.50	00547	18.50 x	24.00 x	2.00	00206	21.00 x	27.00 x	1.40
00974	16.00 x	23.50 x	6.00	01581	18.50 x	25.30 x	2.00	00891	21.00 x	30.00 x	8.00
01289	16.00 x	24.00 x	5.00	01149	18.50 x	60.00 x	17.50	01474	21.00 x	32.00 x	2.50
00066	16.00 x	25.00 x	4.00	01231	18.50 x	103.00 x	8.00	01877	21.00 x	32.00 x	9.00
00569	16.00 x	26.00 x	3.20	01450	19.00 x	21.00 x	13.00	01180	21.00 x	34.00 x	11.80
01691	16.00 x	27.00 x	5.00	USIN	19.00 x	22.00 x	3.00	01912	21.00 x	35.50 x	2.00
00311	16.00 x	28.00 x	3.00	01580	19.00 x	23.20 x	1.30	01900	21.00 x	35.50 x	6.35
00467	16.00 x	29.00 x	12.70	USIN	19.00 x	24.00 x	1.00	01980	21.00 x	36.00 x	2.00
01455	16.00 x	31.00 x	8.00	00916	19.00 x	26.00 x	8.00	USIN	21.30 x	26.20 x	4.00
00880	19.00 x	27.00 x	10.00	01109	19.00 x	28.50 x	5.00	01911	21.34 x	53.98 x	1.59
01109	19.00 x	28.50 x	5.00	00214	19.00 x	29.00 x	2.10	USIN	21.50 x	25.10 x	1.30
00214	19.00 x	29.00 x	2.10	01459	19.00 x	31.00 x	14.30	USIN	21.50 x	26.00 x	1.20
01459	19.00 x	31.00 x	14.30	01994	19.00 x	40.00 x	5.00	00316	21.50 x	27.00 x	2.40
01994	19.00 x	40.00 x	5.00	01518	19.00 x	65.00 x	8.00	01896	21.50 x	27.00 x	2.50
00593	21.50 x	28.00 x	2.30	00809	19.05 x	22.22 x	2.40	00593	21.50 x	28.00 x	2.30
00654	21.50 x	28.50 x	3.50	00420	19.05 x	24.20 x	2.80	01996	21.70 x	28.00 x	3.20
01996	21.70 x	28.00 x	3.20	00211	19.05 x	24.61 x	5.50	01638	21.80 x	29.00 x	2.00
01638	21.80 x	29.00 x	2.00	01102	19.05 x	28.50 x	1.50	01689	21.80 x	29.00 x	2.00
01689	21.80 x	29.00 x	2.00	00168	19.05 x	28.57 x	6.75	01655	21.80 x	29.00 x	2.00
01655	21.80 x	29.00 x	2.00	00229	19.05 x	31.75 x	4.76	USIN	22.00 x	24.00 x	3.00

								INCOVE VEDAÇÕES LTDA.			
Código	Di x	De x	Ha1	Código	Di x	De x	Ha1	Código	Di x	De x	Ha1
USIN	22.00 x	25.00 x	3.00	01919	24.40 x	31.40 x	3.50	USIN	27.00 x	31.50 x	10.50
USIN	22.00 x	25.60 x	1.60	USIN	24.50 x	29.00 x	1.50	01616	27.00 x	32.00 x	4.00
USIN	22.00 x	26.00 x	4.10	ESPECI	24.50 x	29.60 x	3.90	USIN	27.00 x	33.00 x	3.05
USIN	22.00 x	27.20 x	3.80	01788	24.50 x	30.00 x	4.00	01607	27.00 x	33.20 x	2.00
00001	22.00 x	30.00 x	2.00	00775	24.50 x	30.50 x	1.50	00653	27.00 x	34.00 x	3.50
00871	22.00 x	30.00 x	4.00	CORT	24.50 x	30.50 x	1.80	01643	27.00 x	34.50 x	3.20
00559	22.00 x	32.00 x	2.00	01650	24.50 x	32.00 x	4.50	00650	27.00 x	38.00 x	1.80
01842	22.00 x	33.70 x	3.40	01272	24.60 x	35.50 x	10.00	01617	27.00 x	42.00 x	9.00
01080	22.00 x	34.00 x	2.00	CORT	25.00 x	28.70 x	0.80	USIN	27.00 x	50.00 x	6.00
00148	22.00 x	35.00 x	5.60	01160	25.00 x	31.00 x	2.00	00034	27.00 x	57.00 x	3.10
00612	22.00 x	35.00 x	6.00	01509	25.00 x	32.00 x	1.30	00330	27.00 x	65.50 x	2.00
01361	22.00 x	37.00 x	4.00	01598	25.00 x	32.00 x	2.50	USIN	27.30 x	33.00 x	1.02
00621	22.00 x	40.00 x	5.00	00687	25.00 x	32.00 x	5.50	00531	27.40 x	35.00 x	2.00
01398	22.00 x	52.00 x	1.70	01367	25.00 x	33.00 x	6.00	01510	27.50 x	32.50 x	4.00
00116	22.20 x	26.60 x	1.30	00337	25.00 x	33.00 x	6.00	01592	27.50 x	33.50 x	1.30
USIN	22.22 x	25.40 x	0.99	00464	25.00 x	35.00 x	2.00	00947	27.50 x	35.10 x	3.50
01071	22.22 x	28.00 x	1.20	00822	25.00 x	35.00 x	3.00	00947	27.50 x	35.10 x	3.50
01846	22.22 x	38.10 x	3.17	00822	25.00 x	35.00 x	3.00	01138	27.80 x	30.60 x	1.30
00723	22.22 x	57.15 x	1.00	USIN	25.00 x	35.00 x	4.00	USIN	27.80 x	30.80 x	2.50
00700	22.22 x	57.15 x	25.40	00954	25.00 x	35.00 x	6.00	USIN	28.00 x	31.00 x	9.50
01601	22.30 x	25.30 x	1.60	USIN	25.00 x	35.00 x	7.00	USIN	28.00 x	32.00 x	8.00
00062	22.40 x	30.00 x	2.00	USIN	25.00 x	35.50 x	5.00	00285	28.00 x	33.00 x	3.60
00301	22.50 x	28.00 x	2.00	01271	25.00 x	36.00 x	10.00	01419	28.00 x	36.50 x	5.00
01425	22.70 x	25.90 x	3.10	00055	25.00 x	40.00 x	9.00	00352	28.00 x	40.00 x	2.00
00228	22.80 x	30.80 x	3.20	01441	25.00 x	40.00 x	10.00	USIN	28.00 x	44.50 x	6.00
00129	22.80 x	46.00 x	6.00	01280	25.00 x	40.00 x	15.00	01251	28.00 x	45.70 x	9.40
01137	23.00 x	25.60 x	1.30	00094	25.00 x	44.50 x	10.50	01277	28.00 x	46.00 x	6.30
00658	23.00 x	27.00 x	4.00	00920	25.00 x	45.00 x	2.00	USIN	28.00 x	47.00 x	6.00
00706	23.00 x	28.00 x	2.50	01335	25.00 x	65.00 x	3.00	01461	28.00 x	48.00 x	3.00
00161	23.00 x	28.00 x	2.50	01098	25.00 x	89.00 x	13.00	01463	28.00 x	49.00 x	3.00
01862	23.00 x	29.50 x	2.00	01574	25.40 x	31.30 x	1.30	CORT	28.00 x	54.00 x	0.80
01591	23.00 x	30.00 x	3.70	01496	25.40 x	32.40 x	3.50	01327	28.00 x	59.00 x	8.00
01369	23.00 x	31.00 x	3.50	00949	25.40 x	33.00 x	5.50	01694	28.00 x	75.00 x	2.00
00651	23.00 x	33.00 x	4.00	01992	25.40 x	35.00 x	5.30	01694	28.00 x	75.00 x	2.00
01847	23.00 x	36.60 x	6.20	00632	25.40 x	36.51 x	3.18	USIN	28.30 x	35.00 x	2.00
01260	23.00 x	38.00 x	4.00	00581	25.40 x	38.10 x	3.17	01619	28.40 x	32.00 x	0.80
01249	23.10 x	56.00 x	4.50	01038	25.40 x	38.10 x	12.70	USIN	28.50 x	32.50 x	1.60
01749	23.30 x	35.30 x	6.00	00251	25.40 x	39.69 x	6.35	00372	28.50 x	34.50 x	1.30
01749	23.30 x	35.30 x	6.00	01064	25.40 x	55.56 x	6.35	USIN	28.50 x	34.50 x	1.80
00557	23.40 x	27.00 x	3.00	01212	25.41 x	38.10 x	6.35	00290	28.50 x	35.00 x	3.50
USIN	23.50 x	33.50 x	2.00	USIN	25.50 x	29.50 x	8.00	01495	28.50 x	35.00 x	4.00
00111	23.50 x	33.50 x	5.00	00263	25.50 x	33.50 x	1.60	01100	28.50 x	37.00 x	4.20
01372	23.80 x	26.00 x	1.30	00929	25.50 x	35.00 x	5.50	00428	28.50 x	39.00 x	3.50
00115	23.80 x	32.60 x	5.00	00727	25.50 x	39.50 x	1.50	00068	28.57 x	34.92 x	1.59
00771	23.80 x	32.80 x	1.20	USIN	25.60 x	31.70 x	1.20	01775	28.60 x	34.08 x	2.59
00096	23.80 x	36.50 x	12.70	USIN	26.00 x	28.00 x	3.75	01973	28.60 x	50.80 x	4.30
USIN	24.00 x	26.40 x	19.00	USIN	26.00 x	28.50 x	1.80	00110	28.70 x	41.40 x	12.70
01062	24.00 x	30.00 x	1.30	00772	26.00 x	30.70 x	1.00	00760	28.70 x	41.50 x	12.70
00162	24.00 x	30.00 x	2.00	00675	26.00 x	31.00 x	1.00	00781	28.70 x	41.50 x	12.70
00152	24.00 x	30.00 x	5.00	01401	26.00 x	31.70 x	2.00	00751	28.98 x	34.98 x	2.30
00459	24.00 x	33.00 x	1.10	01321	26.00 x	32.00 x	1.50	00873	29.00 x	31.80 x	1.00
00419	24.00 x	34.00 x	3.00	00445	26.00 x	32.00 x	4.20	USIN	29.00 x	32.00 x	3.00
01458	24.00 x	39.60 x	13.00	01452	26.00 x	33.00 x	1.30	00608	29.00 x	34.00 x	1.00
01754	24.00 x	40.00 x	8.00	00855	26.00 x	35.00 x	4.80	00984	29.00 x	35.00 x	1.40
00892	24.28 x	28.64 x	11.40	01072	26.00 x	40.00 x	5.50	00713	29.00 x	35.35 x	3.17
01099	26.00 x	40.00 x	6.50	01099	26.00 x	40.00 x	6.50	01303	29.00 x	40.00 x	4.30
01015	26.00 x	52.00 x	7.00	01015	26.00 x	52.00 x	7.00	00400	29.00 x	49.50 x	2.00
01380	26.30 x	32.00 x	1.50	01380	26.30 x	32.00 x	1.50	00652	29.00 x	56.00 x	12.00
USIN	26.30 x	36.30 x	2.00	USIN	26.30 x	36.30 x	2.00	00662	29.00 x	58.60 x	8.10
00303	26.50 x	38.00 x	12.00	00303	26.50 x	38.00 x	12.00	00497	29.03 x	33.39 x	1.40
00613	26.50 x	39.50 x	6.50	00613	26.50 x	39.50 x	6.50	02009	29.05 x	44.45 x	1.58
00387	26.50 x	41.00 x	1.20	00387	26.50 x	41.00 x	1.20	00286	29.50 x	32.10 x	1.30
00137	26.99 x	39.69 x	6.35	00137	26.99 x	39.69 x	6.35	00024	29.50 x	39.50 x	4.70
00817	27.00 x	3.20 x	2.50	00817	27.00 x	3.20 x	2.50	01764	29.80 x	34.80 x	3.80
01156	27.00 x	31.00 x	5.00	01156	27.00 x	31.00 x	5.00	00153	29.80 x	40.20 x	6.50
USIN	27.00 x	31.00 x	8.00	USIN	27.00 x	31.00 x	8.00	00746	30.00 x	31.70 x	5.20
								USIN	30.00 x	32.80 x	4.00

								INCOLVE VEDAÇÕES LTDA.			
Código	Di x	De x	Ha1	Código	Di x	De x	Ha1	Código	Di x	De x	Ha1
01259	30.00 x	33.00 x	2.00	01007	32.00 x	40.00 x	5.50	00436	35.00 x	43.00 x	1.80
USIN	30.00 x	34.00 x	9.50	USIN	32.00 x	41.00 x	1.00	01189	35.00 x	43.00 x	4.00
USIN	30.00 x	35.00 x	1.00	01982	32.00 x	41.00 x	2.00	00457	35.00 x	43.00 x	6.50
01134	30.00 x	35.00 x	3.00	00528	32.00 x	42.00 x	1.60	01486	35.00 x	43.50 x	2.00
01422	30.00 x	36.00 x	3.80	00896	32.00 x	42.00 x	7.00	USIN	35.00 x	44.45 x	1.50
USIN	30.00 x	38.00 x	5.00	01084	32.00 x	44.50 x	2.00	01044	35.00 x	45.00 x	2.00
01686	30.00 x	38.50 x	4.50	01772	32.00 x	48.00 x	3.00	01540	35.00 x	45.00 x	2.30
00774	30.00 x	38.60 x	2.00	00836	32.00 x	48.00 x	4.50	01790	35.00 x	45.30 x	4.80
00682	30.00 x	40.00 x	5.60	01864	32.00 x	51.50 x	2.00	01652	35.00 x	48.00 x	6.00
00784	30.00 x	40.00 x	6.00	00209	32.00 x	54.00 x	8.00	01695	35.00 x	49.00 x	7.00
00091	30.00 x	40.00 x	10.00	00780	32.00 x	57.00 x	14.50	00994	35.00 x	50.00 x	1.50
01840	30.00 x	42.20 x	3.40	00780	32.00 x	57.00 x	14.50	00056	35.00 x	51.00 x	3.20
01328	30.00 x	46.00 x	9.00	00948	32.00 x	59.00 x	2.00	USIN	35.00 x	55.00 x	8.00
02017	30.00 x	49.00 x	3.00	00668	32.00 x	66.00 x	8.00	01035	35.00 x	65.00 x	3.17
00310	30.00 x	50.00 x	15.00	00788	32.50 x	38.52 x	1.85	00910	35.00 x	70.00 x	12.00
01235	30.00 x	52.00 x	5.00	USIN	32.50 x	39.80 x	2.00	00396	35.00 x	73.00 x	10.00
01841	30.00 x	54.00 x	3.40	00543	32.50 x	40.00 x	20.50	01236	35.00 x	80.00 x	14.00
01171	30.00 x	54.00 x	8.00	01885	32.50 x	51.50 x	2.00	USIN	35.50 x	39.50 x	4.90
01456	30.00 x	55.00 x	2.80	USIN	32.85 x	38.40 x	3.90	01107	35.50 x	39.70 x	10.20
00128	30.00 x	62.00 x	5.00	01645	33.00 x	36.00 x	1.20	01528	35.50 x	40.50 x	4.00
01820	30.30 x	35.70 x	2.70	USIN	33.00 x	36.00 x	1.40	00660	35.50 x	41.00 x	4.00
01741	30.30 x	35.70 x	2.70	USIN	33.00 x	39.00 x	1.50	00106	35.50 x	63.00 x	14.00
00317	30.30 x	35.90 x	2.00	00695	33.00 x	40.00 x	3.50	01999	35.50 x	95.00 x	13.00
00244	30.60 x	33.00 x	2.00	00924	33.00 x	41.00 x	4.00	01964	35.60 x	47.00 x	4.20
00401	30.96 x	39.68 x	4.36	01226	33.00 x	41.50 x	4.30	01700	35.75 x	42.49 x	3.37
00502	30.99 x	37.59 x	1.02	01088	33.00 x	44.00 x	5.30	01490	35.80 x	38.90 x	4.50
00058	31.00 x	38.00 x	5.00	01814	33.00 x	45.00 x	4.00	01886	36.00 x	40.60 x	8.50
00238	31.00 x	51.50 x	4.50	01779	33.00 x	47.00 x	2.00	USIN	36.00 x	41.00 x	0.80
01974	31.00 x	54.70 x	4.60	01343	33.00 x	49.00 x	9.00	USIN	36.00 x	41.00 x	4.00
01974	31.00 x	54.70 x	4.60	00917	33.00 x	55.00 x	30.00	USIN	36.00 x	41.00 x	4.60
00633	31.00 x	56.00 x	4.00	01582	33.20 x	46.00 x	5.00	00941	36.00 x	43.00 x	1.50
USIN	31.20 x	36.50 x	1.50	00089	33.34 x	47.62 x	7.94	00481	36.00 x	47.00 x	8.00
01114	31.30 x	38.50 x	2.13	00121	33.34 x	54.37 x	6.00	01246	36.00 x	51.00 x	15.00
01590	31.30 x	40.00 x	7.10	00691	33.40 x	40.00 x	3.30	01606	36.00 x	52.00 x	3.00
01515	31.40 x	38.50 x	3.80	USIN	33.50 x	41.00 x	1.00	00865	36.00 x	57.00 x	6.00
USIN	31.50 x	34.40 x	1.90	USIN	33.50 x	41.00 x	1.00	USIN	36.10 x	41.20 x	4.00
00314	31.50 x	36.50 x	2.40	01089	33.50 x	43.50 x	2.50	01336	36.10 x	45.60 x	7.00
01584	31.50 x	39.90 x	7.00	USIN	33.50 x	70.00 x	0.80	00249	36.20 x	40.20 x	1.60
00616	31.60 x	36.70 x	7.40	01610	33.80 x	40.50 x	1.80	01736	36.50 x	39.40 x	4.00
USIN	31.70 x	36.50 x	1.00	01443	33.90 x	41.50 x	3.50	01106	36.50 x	39.70 x	4.60
01219	31.70 x	38.00 x	1.50	00711	34.00 x	38.00 x	2.00	01190	36.50 x	39.90 x	1.50
00544	31.70 x	38.00 x	3.70	00834	34.00 x	39.00 x	1.00	00787	36.50 x	41.50 x	1.98
00935	31.75 x	38.81 x	1.77	USIN	34.00 x	41.20 x	4.00	01665	36.50 x	47.50 x	5.80
00142	31.75 x	53.97 x	8.73	01329	34.00 x	49.00 x	6.00	00495	36.50 x	49.00 x	9.00
00415	31.75 x	80.00 x	20.00	00132	34.00 x	49.00 x	6.40	00302	37.00 x	40.00 x	1.50
00415	31.75 x	80.00 x	20.00	01462	34.00 x	49.00 x	12.00	00806	37.00 x	45.00 x	2.00
01451	32.00 x	36.00 x	0.50	00256	34.00 x	49.50 x	6.50	01060	37.00 x	46.00 x	6.50
01449	32.00 x	36.00 x	6.00	01342	34.00 x	51.00 x	16.00	01874	37.00 x	49.00 x	9.00
USIN	32.00 x	37.00 x	2.30	01756	34.00 x	51.60 x	10.00	00141	37.00 x	54.00 x	4.50
00322	32.00 x	38.00 x	1.30	01848	34.00 x	55.00 x	4.85	01227	37.00 x	73.60 x	9.30
00854	32.00 x	38.00 x	1.30	00731	34.00 x	57.00 x	6.00	01395	37.00 x	86.00 x	11.00
01487	32.00 x	38.00 x	2.00	00705	34.50 x	39.50 x	2.50	00753	37.06 x	43.06 x	2.30
01433	32.00 x	38.00 x	5.00	USIN	34.50 x	40.00 x	5.50	00212	37.25 x	50.80 x	4.70
00626	32.00 x	40.00 x	1.00	00721	34.50 x	41.50 x	2.50	USIN	37.50 x	41.50 x	8.00
00558	32.00 x	40.00 x	4.50	00825	34.80 x	41.20 x	2.00	01972	37.50 x	42.50 x	1.90
00208	34.92 x	41.27 x	3.97	00208	34.92 x	41.27 x	3.97	01529	37.50 x	42.50 x	4.00
00840	34.92 x	42.86 x	1.60	00840	34.92 x	42.86 x	1.60	USIN	37.50 x	45.00 x	1.20
00114	34.92 x	52.39 x	7.14	00114	34.92 x	52.39 x	7.14	00029	37.50 x	60.00 x	1.60
01333	34.93 x	4.28 x	4.76	01333	34.93 x	4.28 x	4.76	01167	37.60 x	45.00 x	2.30
00919	35.00 x	39.00 x	3.00	00919	35.00 x	39.00 x	3.00	00921	37.77 x	43.01 x	1.70
USIN	35.00 x	39.00 x	3.50	USIN	35.00 x	39.00 x	3.50	01021	37.80 x	66.80 x	9.00
00990	35.00 x	39.20 x	1.50	00990	35.00 x	39.20 x	1.50	01647	38.00 x	40.20 x	1.70
01199	35.00 x	40.00 x	1.35	01199	35.00 x	40.00 x	1.35	00151	38.00 x	42.40 x	1.30
01556	35.00 x	41.48 x	1.27	01556	35.00 x	41.48 x	1.27	01389	38.00 x	42.80 x	1.50
01755	35.00 x	42.00 x	3.50	01755	35.00 x	42.00 x	3.50	01436	38.00 x	45.00 x	1.80
01323	35.00 x	42.00 x	4.00	01323	35.00 x	42.00 x	4.00	00688	38.00 x	48.00 x	5.50
00261	35.00 x	43.00 x	1.50	00261	35.00 x	43.00 x	1.50	01865	38.00 x	50.00 x	5.00

								INCOVE VEDAÇÕES LTDA.			
Código	Di x	De x	Ha1	Código	Di x	De x	Ha1	Código	Di x	De x	Ha1
00611	38.00	x	2.00	01680	40.00	x	5.00	USIN	44.00	x	2.30
01179	38.00	x	5.50	01438	40.00	x	7.50	01423	44.00	x	4.00
01937	38.00	x	10.30	01512	40.00	x	5.00	01094	44.00	x	15.00
01325	38.00	x	7.00	00438	40.00	x	2.00	01482	44.00	x	1.50
01011	38.10	x	1.30	01252	40.00	x	5.00	00681	44.00	x	5.00
01467	38.10	x	6.00	00398	40.00	x	2.00	01705	44.00	x	4.00
00119	38.10	x	1.59	00735	40.00	x	13.00	01029	44.00	x	1.50
01065	38.10	x	6.35	01761	40.00	x	3.00	01476	44.00	x	10.00
01238	38.10	x	6.35	00201	40.00	x	5.00	00493	44.00	x	7.00
00533	38.10	x	23.81	00503	40.16	x	1.40	01808	44.00	x	7.50
01213	38.10	x	8.00	00149	40.20	x	1.30	01139	44.20	x	2.30
01123	38.10	x	6.00	01270	40.20	x	7.20	00764	44.45	x	3.17
00610	38.20	x	1.10	01269	40.30	x	7.40	01628	44.45	x	3.00
01001	38.50	x	4.00	USIN	40.50	x	1.40	01237	44.45	x	8.00
USIN	38.50	x	8.90	00640	40.50	x	5.40	01161	44.45	x	9.50
00973	38.50	x	6.00	01292	41.00	x	2.70	00886	44.50	x	12.00
01435	38.60	x	1.70	01748	41.00	x	1.00	01943	44.50	x	2.50
00893	38.66	x	1.02	01729	41.00	x	1.40	01963	44.50	x	1.70
01642	39.00	x	3.00	01308	41.00	x	2.70	USIN	44.50	x	9.50
00560	39.00	x	3.20	USIN	41.00	x	4.00	01517	44.50	x	3.00
01429	39.00	x	2.00	00526	41.00	x	3.20	01506	44.50	x	3.00
01849	39.00	x	4.00	00526	41.00	x	3.20	01314	44.50	x	7.94
00849	39.00	x	11.00	00306	41.00	x	1.00	USIN	44.50	x	4.00
01709	39.00	x	3.00	00073	41.00	x	3.00	00462	44.50	x	1.60
00563	39.00	x	9.00	00140	41.00	x	6.40	00851	44.50	x	11.00
01108	39.00	x	13.00	01121	41.00	x	7.00	01413	44.50	x	2.80
01122	39.00	x	13.00	00449	41.00	x	8.00	00773	44.50	x	4.80
01263	39.00	x	9.70	01082	41.00	x	25.00	USIN	44.61	x	19.05
USIN	39.10	x	2.50	00123	41.27	x	3.17	01596	44.70	x	3.00
01935	39.20	x	3.00	00254	41.27	x	6.35	01699	44.75	x	5.43
00284	39.40	x	3.50	00075	41.27	x	9.52	00050	44.80	x	13.00
00099	39.50	x	1.70	00109	41.30	x	5.00	USIN	44.85	x	4.80
01867	39.50	x	1.10	00980	41.30	x	2.80	01752	45.00	x	1.30
01503	39.50	x	4.30	USIN	41.50	x	7.00	00945	45.00	x	1.30
00102	39.50	x	6.80	00564	41.50	x	2.80	01315	45.00	x	4.00
———	39.69	x	6.35	01585	41.50	x	3.90	USIN	45.00	x	4.20
00763	39.70	x	6.65	CORT	41.50	x	1.80	01649	45.00	x	1.20
USIN	40.00	x	7.00	00507	41.50	x	3.00	00318	45.00	x	1.30
00943	40.00	x	2.00	01536	41.50	x	2.50	01595	45.00	x	1.50
00943	40.00	x	2.00	00486	41.50	x	2.00	01595	45.00	x	1.50
00262	40.00	x	1.30	USIN	42.00	x	1.50	01483	45.00	x	3.00
USIN	40.00	x	0.40	00480	42.00	x	1.50	USIN	45.00	x	0.35
USIN	40.00	x	2.50	01936	42.00	x	1.00	01711	45.00	x	1.00
01673	40.00	x	3.00	00754	42.00	x	2.40	00609	45.00	x	6.00
USIN	40.00	x	9.50	01079	42.00	x	2.50	00275	45.00	x	5.00
00250	40.00	x	2.60	00615	42.00	x	6.00	00785	45.00	x	10.00
00391	40.00	x	4.00	00103	42.00	x	8.00	00080	45.00	x	6.00
00391	40.00	x	4.00	00064	42.00	x	4.00	USIN	45.00	x	6.00
00443	40.00	x	4.50	USIN	42.00	x	3.00	01153	45.00	x	1.00
01243	40.00	x	3.20	00879	42.00	x	3.50	00995	45.00	x	0.80
01593	40.00	x	1.50	01832	42.00	x	4.00	01771	45.00	x	3.00
00875	40.00	x	4.00	00181	42.00	x	4.70	00968	45.00	x	35.00
00875	40.00	x	4.00	CORT	42.00	x	18.00	01376	45.00	x	15.00
USIN	40.00	x	5.00	01882	42.50	x	8.00	00732	45.00	x	12.70
00690	40.00	x	5.00	01351	42.86	x	3.57	CORT	45.00	x	7.00
01887	43.00	x	8.50	01887	43.00	x	8.50	01365	45.50	x	4.00
USIN	43.00	x	15.00	USIN	43.00	x	15.00	01017	45.50	x	1.30
01567	43.00	x	1.50	01567	43.00	x	1.50	00664	45.50	x	3.50
00213	43.00	x	8.00	00213	43.00	x	8.00	00722	45.50	x	2.90
00060	43.00	x	9.00	00060	43.00	x	9.00	01872	45.50	x	7.30
01967	43.00	x	4.30	01967	43.00	x	4.30	USIN	45.80	x	1.50
00071	43.00	x	7.00	00071	43.00	x	7.00	00059	46.00	x	1.50
01648	43.00	x	8.00	01648	43.00	x	8.00	USIN	46.00	x	6.35
00578	43.00	x	7.00	00578	43.00	x	7.00	01013	46.00	x	1.00
01095	43.10	x	4.50	01095	43.10	x	4.50	00846	46.00	x	2.00
00769	43.50	x	1.70	00769	43.50	x	1.70	01232	46.00	x	6.00
00778	43.50	x	4.00	00778	43.50	x	4.00	00354	46.00	x	13.50

								INCOLVE VEDAÇÕES LTDA.			
Código	Di x	De x	Ha1	Código	Di x	De x	Ha1	Código	Di x	De x	Ha1
01363	46.50 x	50.70 x	1.30	01417	50.00 x	60.00 x	2.00	00628	53.00 x	65.00 x	2.00
00276	46.50 x	51.00 x	6.00	00730	50.00 x	60.00 x	3.00	01324	53.00 x	65.00 x	6.00
01105	46.50 x	60.50 x	5.10	01745	50.00 x	61.00 x	5.50	01527	53.00 x	65.00 x	6.00
00036	46.50 x	95.50 x	1.50	01945	50.00 x	61.20 x	1.60	00074	53.00 x	82.00 x	5.50
01091	46.80 x	51.00 x	2.00	01279	50.00 x	61.20 x	4.15	01915	53.50 x	57.50 x	3.20
00982	46.99 x	57.65 x	1.80	01439	50.00 x	61.50 x	2.40	00683	53.50 x	65.00 x	4.50
01354	47.00 x	50.20 x	1.70	01780	50.00 x	62.00 x	12.00	00604	53.57 x	60.63 x	1.70
01728	47.00 x	52.00 x	1.40	00474	50.00 x	65.00 x	6.40	01609	53.97 x	101.60 x	9.50
USIN	47.00 x	53.00 x	1.78	00474	50.00 x	65.00 x	6.40	01083	53.98 x	76.20 x	12.70
01484	47.00 x	54.00 x	3.50	01635	50.00 x	65.50 x	5.80	USIN	54.00 x	58.00 x	2.35
01485	47.00 x	55.00 x	1.70	01635	50.00 x	65.50 x	5.80	01569	54.00 x	58.00 x	3.50
00025	47.00 x	55.00 x	4.00	00088	50.00 x	66.00 x	7.00	00740	54.00 x	60.00 x	1.00
00693	47.00 x	55.00 x	4.00	01169	50.00 x	69.00 x	5.70	01570	54.00 x	60.00 x	1.50
01924	47.00 x	57.00 x	5.50	00299	50.00 x	73.00 x	8.00	00876	54.00 x	60.00 x	3.50
01878	47.00 x	58.00 x	11.00	00736	50.00 x	80.00 x	6.00	USIN	54.00 x	60.00 x	13.00
00607	47.27 x	57.15 x	9.50	00864	50.00 x	81.50 x	4.00	00867	54.00 x	64.00 x	5.00
00777	47.40 x	53.00 x	6.10	01068	50.00 x	82.00 x	3.17	00393	54.00 x	66.00 x	1.50
00791	47.46 x	54.15 x	2.00	CORT	50.00 x	97.00 x	13.00	00098	54.00 x	66.00 x	5.00
USIN	47.50 x	50.97 x	3.07	02000	50.00 x	118.00 x	13.00	00453	54.00 x	70.00 x	12.00
00762	47.52 x	59.90 x	5.07	00618	50.00 x	125.00 x	15.00	01738	54.00 x	72.00 x	2.00
00101	47.62 x	50.80 x	1.59	01637	50.13 x	58.10 x	3.00	01224	54.10 x	58.10 x	3.85
USIN	48.00 x	52.00 x	4.20	01273	50.20 x	60.20 x	12.70	USIN	54.50 x	63.00 x	1.50
00423	48.00 x	54.00 x	2.50	01873	50.30 x	55.20 x	3.00	01488	54.50 x	63.50 x	1.70
USIN	48.00 x	54.29 x	2.90	01863	50.30 x	58.40 x	12.40	00430	54.50 x	89.50 x	2.15
01942	48.00 x	60.00 x	2.50	00631	50.50 x	150.00 x	20.00	00342	54.62 x	63.00 x	6.50
00767	48.00 x	60.00 x	4.50	00986	50.80 x	55.80 x	1.50	01588	55.00 x	17.50 x	0.55
01669	48.00 x	60.00 x	6.40	01670	50.80 x	55.80 x	2.50	00487	55.00 x	59.00 x	1.30
00496	48.18 x	54.18 x	1.30	01852	50.80 x	56.40 x	2.80	USIN	55.00 x	60.00 x	10.00
01525	48.40 x	58.00 x	2.00	00133	50.80 x	57.50 x	3.50	00193	55.00 x	61.00 x	2.00
USIN	48.70 x	50.70 x	5.50	00448	50.80 x	59.80 x	2.50	01196	55.00 x	62.00 x	6.00
00689	49.00 x	55.00 x	2.80	00904	50.80 x	66.00 x	5.30	00267	55.00 x	63.00 x	2.50
USIN	49.00 x	56.00 x	6.00	00139	50.80 x	66.67 x	6.35	USIN	55.00 x	64.40 x	1.50
00293	49.00 x	59.00 x	5.00	00026	50.80 x	66.67 x	15.08	01513	55.00 x	72.00 x	7.00
00887	49.00 x	60.00 x	2.50	00281	50.80 x	76.20 x	6.35	01214	55.00 x	80.00 x	12.50
00482	49.00 x	60.00 x	9.00	01812	50.80 x	84.00 x	8.00	00857	55.00 x	90.00 x	3.30
01576	49.30 x	54.50 x	14.50	01129	50.97 x	55.90 x	2.50	00381	55.50 x	58.70 x	1.60
00150	49.40 x	63.00 x	8.00	00122	51.00 x	55.00 x	1.60	01200	55.50 x	60.00 x	2.00
01322	49.50 x	56.30 x	3.50	00122	51.00 x	55.00 x	1.60	00527	55.50 x	68.70 x	3.80
USIN	49.50 x	57.00 x	1.00	01716	51.00 x	57.00 x	0.70	00739	55.56 x	59.56 x	1.19
00966	49.50 x	59.10 x	6.30	01710	51.00 x	57.00 x	1.20	00915	55.56 x	66.68 x	4.76
01664	49.51 x	60.00 x	5.50	00260	51.00 x	60.50 x	1.60	01850	55.60 x	67.00 x	6.00
01228	50.00 x	54.20 x	3.85	01187	51.00 x	61.00 x	5.50	01491	55.70 x	94.50 x	1.70
01364	50.00 x	54.40 x	1.35	01261	51.00 x	69.00 x	5.00	00595	56.00 x	60.40 x	2.20
USIN	50.00 x	55.00 x	5.00	01081	51.00 x	76.00 x	25.00	01811	56.00 x	63.00 x	3.00
01792	50.00 x	55.00 x	9.50	00656	51.00 x	85.00 x	2.00	01811	56.00 x	63.00 x	3.00
USIN	50.00 x	56.00 x	0.50	01332	51.10 x	57.00 x	3.00	00789	56.00 x	63.62 x	1.91
USIN	50.00 x	56.00 x	0.70	00748	51.13 x	60.43 x	2.70	01639	56.00 x	66.00 x	6.50
USIN	50.00 x	56.00 x	1.20	00790	51.45 x	62.50 x	1.62	USIN	56.48 x	60.24 x	3.04
00667	50.00 x	56.00 x	3.00	00371	51.50 x	62.50 x	1.50	01892	56.50 x	59.99 x	6.19
USIN	50.00 x	56.00 x	6.35	01040	51.50 x	67.50 x	6.00	USIN	56.50 x	63.00 x	19.00
01674	50.00 x	58.00 x	0.40	00852	51.50 x	80.00 x	11.00	02002	56.50 x	82.50 x	1.58
00805	50.00 x	58.00 x	2.00	01362	51.60 x	67.20 x	6.50	00591	56.50 x	90.50 x	2.00
01432	50.00 x	58.00 x	2.50	01676	51.70 x	63.50 x	3.25	00680	56.87 x	60.43 x	1.78
01740	50.00 x	58.00 x	5.50	1947	52.00 x	56.00 x	4.00	02010	57.00 x	62.00 x	1.20
00942	50.00 x	58.60 x	7.50	USIN	52.00 x	57.00 x	1.50	01276	57.00 x	62.00 x	5.50
00819	52.00 x	57.00 x	2.50	00819	52.00 x	57.00 x	2.50	USIN	57.00 x	63.00 x	4.70
00661	52.00 x	59.00 x	3.50	00661	52.00 x	59.00 x	3.50	00866	57.00 x	63.00 x	12.00
01696	52.00 x	62.00 x	3.00	01696	52.00 x	62.00 x	3.00	01191	57.00 x	63.20 x	1.60
00832	52.00 x	62.00 x	4.50	00832	52.00 x	62.00 x	4.50	00343	57.00 x	64.00 x	1.30
00765	52.00 x	62.00 x	5.50	00765	52.00 x	62.00 x	5.50	01693	57.00 x	64.00 x	4.00
01834	52.00 x	63.00 x	4.40	01834	52.00 x	63.00 x	4.40	02001	57.00 x	67.00 x	2.00
00107	52.00 x	66.60 x	3.50	00107	52.00 x	66.60 x	3.50	00792	57.00 x	68.00 x	19.00
00235	52.00 x	68.00 x	10.00	00235	52.00 x	68.00 x	10.00	00831	57.00 x	69.00 x	1.30
01970	52.00 x	84.00 x	2.00	01970	52.00 x	84.00 x	2.00	00282	57.00 x	71.00 x	10.00
01428	53.00 x	60.00 x	1.40	01428	53.00 x	60.00 x	1.40	00030	57.00 x	74.50 x	5.00
01968	53.00 x	62.60 x	3.20	01968	53.00 x	62.60 x	3.20	01858	57.15 x	60.20 x	3.18
01544	53.00 x	63.40 x	8.00	01544	53.00 x	63.40 x	8.00	00708	57.15 x	61.91 x	2.38



								INCOVE VEDAÇÕES LTDA.			
Código	Di x	De x	Ha1	Código	Di x	De x	Ha1	Código	Di x	De x	Ha1
00890	57.15 x	73.03 x	7.94	00399	60.00 x	85.00 x	2.00	00870	65.50 x	90.00 x	1.50
00082	57.15 x	76.20 x	9.52	00783	60.00 x	115.00 x	1.00	00429	65.77 x	81.44 x	3.24
01890	57.70 x	75.70 x	5.00	01824	60.00 x	140.00 x	6.00	01330	65.90 x	70.00 x	0.70
01565	58.00 x	60.00 x	1.50	CORT	60.00 x	— x	7.00	USIN	66.00 x	71.00 x	6.30
USIN	58.00 x	60.00 x	4.80	01821	60.24 x	65.50 x	2.70	00585	66.00 x	75.00 x	2.00
01692	58.00 x	63.00 x	4.00	00940	60.30 x	80.20 x	3.70	01735	66.00 x	75.00 x	10.00
USIN	58.00 x	63.00 x	6.50	00237	60.32 x	79.37 x	6.35	00567	66.00 x	100.00 x	12.00
01568	58.00 x	63.50 x	1.50	00093	60.32 x	79.37 x	6.35	USIN	66.20 x	71.00 x	2.40
01018	58.00 x	64.00 x	1.30	00200	60.32 x	114.30 x	3.17	01500	66.27 x	73.27 x	1.30
00635	58.00 x	65.00 x	3.50	00750	60.78 x	71.08 x	2.70	01132	66.45 x	79.15 x	1.90
00844	58.00 x	68.00 x	1.80	00981	61.00 x	68.00 x	1.70	01128	66.50 x	80.50 x	13.50
01090	58.00 x	70.00 x	6.00	00902	61.00 x	68.00 x	3.00	00845	66.68 x	76.20 x	4.76
00124	58.00 x	74.00 x	8.00	USIN	61.00 x	70.40 x	0.80	01548	66.80 x	72.80 x	1.20
00225	58.00 x	79.00 x	3.00	USIN	61.40 x	63.60 x	8.00	01489	67.00 x	73.00 x	14.90
00053	58.00 x	83.00 x	8.00	USIN	62.00 x	64.00 x	0.80	01489	67.00 x	73.00 x	14.90
01708	58.00 x	88.00 x	3.00	01059	62.00 x	67.00 x	2.50	00500	67.00 x	85.00 x	3.00
01229	58.10 x	62.50 x	3.85	00696	62.00 x	68.00 x	3.00	01533	67.00 x	85.80 x	14.60
01537	58.15 x	61.75 x	10.70	00903	62.00 x	70.50 x	5.80	00273	68.00 x	75.00 x	1.20
01523	58.20 x	63.00 x	1.90	01750	62.00 x	71.00 x	10.50	01215	68.00 x	76.00 x	10.00
.....	58.40 x	— x	10.20	00710	62.00 x	72.00 x	1.50	00859	68.00 x	80.00 x	6.00
00219	58.50 x	61.50 x	1.50	00885	62.00 x	76.00 x	3.00	01284	68.40 x	77.30 x	4.00
01176	58.50 x	65.00 x	1.50	01326	62.00 x	82.00 x	5.50	00733	69.00 x	78.00 x	3.20
00090	58.50 x	87.50 x	3.60	USIN	62.00 x	83.50 x	4.50	01666	69.00 x	78.20 x	5.50
00217	58.74 x	63.50 x	1.80	00881	62.00 x	85.00 x	6.00	01475	69.00 x	86.00 x	4.00
00083	58.74 x	82.55 x	4.76	01956	62.00 x	86.00 x	6.50	00341	69.00 x	94.00 x	6.00
USIN	59.00 x	63.00 x	1.30	01225	62.30 x	66.30 x	3.85	01257	69.22 x	78.60 x	2.00
00265	59.00 x	66.00 x	3.50	01853	63.00 x	68.00 x	2.50	01230	69.50 x	73.60 x	3.75
00412	59.00 x	69.00 x	13.00	USIN	63.00 x	70.00 x	0.50	00719	69.80 x	76.40 x	3.60
01368	59.00 x	72.00 x	3.50	01762	63.00 x	70.00 x	1.50	01566	70.00 x	73.00 x	3.50
01866	59.30 x	63.60 x	1.20	01085	63.00 x	70.00 x	2.00	01019	70.00 x	76.00 x	1.30
01572	59.40 x	70.50 x	5.55	01564	63.00 x	70.50 x	3.50	01573	70.00 x	76.00 x	7.00
01468	59.50 x	70.50 x	1.50	01023	63.00 x	73.00 x	2.00	00255	70.00 x	78.00 x	5.00
00368	59.50 x	70.50 x	5.50	01348	63.00 x	75.00 x	13.00	01594	70.00 x	79.00 x	6.00
01113	59.50 x	70.70 x	3.00	01037	63.00 x	100.00 x	3.17	USIN	70.00 x	80.00 x	3.00
USIN	59.50 x	79.50 x	1.50	01621	63.09 x	70.15 x	1.50	00174	70.00 x	80.00 x	5.00
USIN	59.60 x	65.00 x	4.00	00606	63.09 x	70.15 x	1.70	USIN	70.00 x	80.00 x	7.00
00718	59.60 x	66.20 x	3.60	01192	63.50 x	59.90 x	2.70	01168	70.00 x	80.00 x	7.00
00663	59.60 x	71.00 x	4.70	00259	63.50 x	69.00 x	1.30	00579	70.00 x	80.00 x	15.00
01769	59.80 x	69.80 x	3.50	00799	63.50 x	73.02 x	4.76	01701	70.00 x	81.00 x	5.50
01730	60.00 x	63.00 x	6.50	00895	63.50 x	73.50 x	5.50	00483	70.00 x	84.00 x	1.20
01499	60.00 x	65.00 x	3.90	00619	63.50 x	76.20 x	1.59	00821	70.00 x	108.00 x	3.20
00936	60.00 x	65.00 x	4.00	01751	63.50 x	79.40 x	2.10	01981	70.00 x	131.80 x	9.90
USIN	60.00 x	66.00 x	3.00	01734	63.50 x	80.00 x	4.80	USIN	71.00 x	79.00 x	6.00
00216	60.00 x	66.00 x	5.00	01759	63.50 x	80.50 x	4.76	00353	71.00 x	83.00 x	8.00
USIN	60.00 x	70.00 x	2.00	00841	63.50 x	85.00 x	5.50	01442	71.00 x	93.50 x	57.00
01920	60.00 x	71.00 x	9.50	01828	63.50 x	133.50 x	2.00	00270	71.00 x	100.00 x	20.00
01194	60.00 x	72.00 x	7.50	01830	63.50 x	133.50 x	20.00	01770	71.00 x	101.00 x	3.00
00070	60.00 x	75.00 x	2.00	01234	63.60 x	70.00 x	0.40	01599	72.00 x	64.00 x	3.50
00456	60.00 x	75.00 x	3.00	USIN	64.00 x	67.00 x	7.00	01539	72.00 x	78.00 x	7.00
CORT	60.00 x	76.00 x	6.50	00627	64.00 x	69.00 x	1.70	01393	72.00 x	82.00 x	3.00
00361	60.00 x	79.70 x	12.60	01058	64.00 x	69.00 x	1.70	00470	72.00 x	89.00 x	6.00
01605	60.00 x	80.00 x	2.50	01685	64.00 x	69.00 x	25.00	01185	72.00 x	91.00 x	1.60
USIN	60.00 x	80.00 x	3.70	00125	64.00 x	72.00 x	2.00	01466	72.20 x	83.20 x	1.50
00734	60.00 x	80.00 x	6.00	00824	64.00 x	72.50 x	2.00	01618	72.20 x	83.20 x	1.50
00850	60.00 x	80.00 x	11.00	CORT	64.00 x	74.00 x	5.00	01466	72.20 x	83.20 x	2.50
00042	64.00 x	75.00 x	1.50	01175	72.30 x	82.90 x	2.50	01175	72.30 x	82.90 x	2.50
01586	64.00 x	78.00 x	7.00	01154	72.50 x	77.00 x	2.00	01154	72.50 x	77.00 x	2.00
01140	64.20 x	69.20 x	2.30	02007	72.50 x	88.50 x	5.50	02007	72.50 x	88.50 x	5.50
00818	64.30 x	69.90 x	2.50	00837	72.50 x	88.50 x	6.50	00837	72.50 x	88.50 x	6.50
01538	64.50 x	70.50 x	4.00	01526	72.82 x	76.02 x	6.50	01526	72.82 x	76.02 x	6.50
01774	65.00 x	69.50 x	1.50	01836	73.00 x	79.20 x	1.40	01836	73.00 x	79.20 x	1.40
01511	65.00 x	70.00 x	1.00	00987	73.00 x	82.00 x	2.00	00987	73.00 x	82.00 x	2.00
00319	65.00 x	71.00 x	1.30	01555	73.00 x	85.00 x	3.00	01555	73.00 x	85.00 x	3.00
00392	65.00 x	78.00 x	1.50	00207	73.02 x	82.55 x	4.76	00207	73.02 x	82.55 x	4.76
00373	65.00 x	82.40 x	3.20	01222	73.70 x	78.90 x	8.00	01222	73.70 x	78.90 x	8.00
00220	65.00 x	94.00 x	1.80	01909	74.00 x	80.00 x	1.00	01909	74.00 x	80.00 x	1.00
00191	65.00 x	110.00 x	19.00	USIN	74.00 x	80.00 x	9.00	USIN	74.00 x	80.00 x	9.00

Código	Di x	De x	Ha1
USIN	74.40 x	80.00 x	1.40
USIN	74.50 x	78.30 x	6.30
00287	74.50 x	81.00 x	1.30
01819	74.95 x	85.11 x	5.08
01687	75.00 x	81.00 x	1.60
01240	75.00 x	81.00 x	1.90
00280	75.00 x	82.60 x	3.00
CORT	75.00 x	85.00 x	5.00
01030	75.00 x	94.00 x	7.00
00340	75.00 x	99.00 x	2.00
00906	75.00 x	127.00 x	3.00
01473	75.50 x	81.70 x	9.50
USIN	76.00 x	80.00 x	0.80
00793	76.00 x	81.30 x	2.17
01150	76.00 x	82.40 x	14.20
00804	76.00 x	85.00 x	2.00
01634	76.00 x	95.00 x	5.80
01634	76.00 x	95.00 x	5.80
00045	76.00 x	97.00 x	3.00
00782	76.00 x	130.00 x	1.00
00643	76.20 x	83.20 x	1.50
USIN	76.20 x	85.00 x	2.00
00069	76.20 x	85.72 x	3.17
00795	76.20 x	85.80 x	2.00
00272	76.20 x	88.90 x	20.00
00246	76.20 x	93.66 x	6.35
00130	76.20 x	95.25 x	6.35
00913	76.20 x	146.05 x	11.11
USIN	76.50 x	82.50 x	1.30
01148	76.50 x	82.50 x	1.50
00899	76.50 x	109.50 x	5.50
01146	76.70 x	82.70 x	4.60
USIN	77.00 x	82.40 x	1.50
01984	77.00 x	115.00 x	2.00
01498	77.40 x	86.50 x	1.50
00097	77.79 x	85.72 x	2.38
01614	77.80 x	83.80 x	1.20
00439	77.80 x	83.80 x	1.20
USIN	78.00 x	82.00 x	10.00
01404	78.00 x	84.00 x	1.00
01283	78.00 x	84.00 x	4.60
00331	78.00 x	85.00 x	2.00
01613	78.00 x	90.00 x	0.40
00087	78.00 x	93.00 x	7.50
01663	78.00 x	96.00 x	9.00
01387	78.00 x	169.50 x	30.00
01938	78.40 x	84.40 x	3.00
00698	78.50 x	100.00 x	14.70
01245	78.70 x	108.70 x	11.11
USIN	79.00 x	83.00 x	6.00
01480	79.00 x	87.00 x	4.50
01407	79.00 x	104.00 x	2.70
00715	79.00 x	105.00 x	6.00
00136	79.37 x	88.90 x	11.11

Código	Di x	De x	Ha1
01157	79.50 x	83.10 x	2.50
01611	80.00 x	84.00 x	6.00
USIN	80.00 x	86.40 x	3.60
USIN	80.00 x	87.00 x	0.40
01744	80.00 x	87.00 x	2.00
00605	80.00 x	88.00 x	6.00
01288	80.00 x	88.40 x	4.20
00038	80.00 x	90.00 x	2.00
01481	80.00 x	90.00 x	5.00
00444	80.00 x	93.00 x	7.00
CORT	80.00 x	98.00 x	7.50
00369	80.00 x	100.00 x	23.00
00858	80.00 x	126.00 x	3.20
01469	81.00 x	85.25 x	15.00
01184	81.00 x	91.00 x	1.60
01810	81.00 x	93.00 x	11.00
01516	81.00 x	103.50 x	7.00
01520	81.00 x	118.00 x	3.20
01813	82.00 x	86.70 x	1.80
00901	82.00 x	87.00 x	2.00
00958	82.00 x	92.00 x	95.00
00277	82.00 x	95.00 x	5.00
01386	82.00 x	104.00 x	3.00
00172	82.00 x	105.00 x	8.00
00184	82.00 x	110.00 x	8.00
00182	82.00 x	115.00 x	8.00
00185	82.00 x	125.00 x	8.00
00189	82.00 x	130.00 x	8.00
00190	82.00 x	135.00 x	8.00
00196	82.00 x	140.00 x	8.00
00205	82.00 x	145.00 x	8.00
00192	82.00 x	160.00 x	8.00
00198	82.00 x	165.00 x	8.00
00195	82.00 x	170.00 x	8.00
00204	82.00 x	185.00 x	8.00
01785	82.20 x	87.80 x	3.80
00138	82.40 x	89.30 x	3.35
00139	82.40 x	89.30 x	3.35
USIN	82.50 x	86.50 x	12.00
00447	82.50 x	87.50 x	1.50
01268	82.50 x	88.50 x	1.30
01658	82.50 x	93.90 x	7.50
00145	82.55 x	87.31 x	2.00
00063	82.55 x	88.90 x	1.59
00218	82.55 x	112.71 x	2.00
01782	83.00 x	88.00 x	2.60
01120	83.00 x	89.00 x	10.00
01758	83.00 x	90.00 x	2.00
01521	83.00 x	137.00 x	3.20
00644	83.00 x	145.00 x	10.00
00900	83.50 x	106.50 x	5.00
00897	83.50 x	106.50 x	8.00
00117	83.60 x	92.00 x	4.20
01793	84.00 x	87.00 x	5.50
00163	84.00 x	89.00 x	1.70
01334	84.00 x	90.00 x	6.20
01406	84.00 x	104.00 x	7.00
01024	85.00 x	90.00 x	3.80
00525	85.00 x	91.00 x	1.80
01005	85.00 x	95.00 x	1.00
00729	85.00 x	107.00 x	5.30
00625	85.00 x	108.00 x	8.50
01707	85.00 x	121.00 x	3.00
00950	85.00 x	126.00 x	3.00
01396	85.00 x	157.00 x	26.00
01918	85.09 x	95.75 x	2.00
USIN	85.11 x	89.15 x	6.95

INCOLVE VEDAÇÕES LTDA.			
Código	Di x	De x	Ha1
01763	85.50 x	94.50 x	2.00
00638	85.50 x	107.50 x	8.00
02003	85.70 x	114.30 x	1.58
01119	86.00 x	20.00 x	7.00
00375	86.00 x	96.00 x	22.00
01546	86.00 x	98.00 x	2.00
01677	86.31 x	95.61 x	1.52
00471	86.50 x	113.50 x	6.00
00508	87.00 x	97.00 x	4.00
00222	88.00 x	96.00 x	2.50
00394	88.00 x	100.00 x	1.50
00408	88.00 x	106.00 x	5.50
01009	88.00 x	110.00 x	18.80
00046	88.40 x	93.60 x	5.80
01356	88.50 x	88.90 x	4.80
01411	88.50 x	91.50 x	5.00
00033	88.50 x	94.50 x	3.50
00716	88.50 x	95.10 x	3.60
00092	88.50 x	98.50 x	5.00
00745	88.50 x	101.60 x	1.00
00472	88.90 x	95.25 x	1.59
00264	89.00 x	96.00 x	3.50
00629	89.00 x	101.60 x	2.00
00587	89.00 x	113.00 x	8.00
01732	89.00 x	124.00 x	1.00
01796	89.00 x	125.00 x	13.00
00955	89.00 x	125.00 x	13.00
00898	89.00 x	129.00 x	4.50
02019	89.05 x	95.05 x	1.27
1978	89.40 x	95.40 x	1.50
01181	89.50 x	93.70 x	1.50
00320	90.00 x	96.00 x	1.30
01125	90.00 x	96.30 x	1.45
01126	90.00 x	96.50 x	2.50
00039	90.00 x	100.00 x	2.00
00112	90.00 x	100.00 x	5.00
00461	90.00 x	101.50 x	1.60
USIN	90.00 x	102.50 x	1.60
USIN	90.00 x	104.00 x	1.50
01357	90.00 x	105.00 x	14.00
01712	90.00 x	112.00 x	8.00
01385	90.00 x	122.00 x	4.00
01986	90.00 x	132.00 x	2.00
01036	90.00 x	132.00 x	3.70
F14225	90.00 x	160.00 x	24.00
01141	90.20 x	100.20 x	3.50
00499	90.40 x	100.00 x	1.52
01414	90.50 x	100.00 x	2.00
01725	91.00 x	102.00 x	1.00
00847	91.00 x	102.00 x	1.00
01535	91.60 x	98.10 x	25.20
01135	92.00 x	100.00 x	8.00
00926	92.00 x	101.00 x	2.50
00288	92.00 x	102.00 x	2.50
00878	92.00 x	102.00 x	5.00
00405	92.00 x	110.00 x	8.00
01534	92.00 x	110.80 x	12.20
00506	92.07 x	101.60 x	11.11
USIN	93.00 x	99.00 x	12.70
01177	93.00 x	100.00 x	10.10
00223	93.00 x	101.00 x	3.00
00446	93.00 x	105.00 x	2.50
USIN	94.00 x	100.00 x	6.00
USIN	94.00 x	101.00 x	6.00
01933	94.00 x	116.50 x	14.00
01933	94.00 x	116.50 x	14.00
00202	94.30 x	100.70 x	2.30

								INCOVE VEDAÇÕES LTDA.			
Código	Di x	De x	Ha1	Código	Di x	De x	Ha1	Código	Di x	De x	Ha1
USIN	94.50 x	101.50 x	6.00	USIN	101.60 x	107.95 x	0.50	00888	115.00 x	127.00 x	3.00
01786	94.80 x	101.60 x	5.00	00800	101.60 x	111.12 x	4.76	00925	115.00 x	128.00 x	17.00
00922	94.84 x	101.90 x	1.70	01633	101.60 x	113.60 x	3.20	00545	115.00 x	134.00 x	5.00
USIN	95.00 x	99.00 x	1.30	01554	101.60 x	117.50 x	3.20	00894	115.00 x	135.00 x	10.00
01025	95.00 x	100.00 x	2.00	00289	101.60 x	123.80 x	7.00	01983	115.00 x	162.00 x	2.00
00052	95.00 x	101.00 x	1.30	00247	101.60 x	123.82 x	6.35	00749	115.01 x	124.31 x	2.70
01895	95.00 x	101.50 x	2.00	00575	101.60 x	131.00 x	6.35	00054	116.00 x	122.00 x	1.50
00492	95.00 x	103.00 x	4.00	00147	102.00 x	110.00 x	6.00	00183	116.00 x	127.00 x	3.50
01948	95.00 x	105.00 x	3.20	USIN	102.00 x	112.00 x	0.50	01410	116.00 x	147.00 x	3.00
00403	95.00 x	105.00 x	7.00	00636	102.00 x	128.00 x	13.20	00296	117.00 x	127.00 x	2.50
00040	95.00 x	115.00 x	10.00	01183	102.00 x	136.00 x	3.00	02013	118.00 x	123.00 x	14.80
00624	95.00 x	119.00 x	8.00	01497	102.00 x	153.00 x	3.00	00397	118.00 x	130.00 x	8.00
01914	95.00 x	126.00 x	7.00	00630	103.00 x	109.00 x	1.20	00413	118.00 x	131.00 x	18.00
01800	95.00 x	135.00 x	10.00	00324	103.00 x	110.60 x	3.20	01287	118.00 x	231.00 x	42.00
01859	95.10 x	101.50 x	1.00	01907	103.00 x	114.60 x	2.00	01743	119.00 x	126.00 x	19.30
00146	95.25 x	101.60 x	1.80	00105	103.19 x	123.82 x	6.35	01855	119.00 x	155.00 x	10.00
00100	95.25 x	101.60 x	1.98	00326	104.00 x	110.60 x	3.20	01101	120.00 x	126.40 x	6.40
USIN	95.60 x	102.60 x	3.00	00720	104.00 x	113.00 x	1.80	00993	120.00 x	127.20 x	3.10
00494	95.71 x	98.41 x	1.24	00187	104.77 x	123.82 x	6.35	00067	120.00 x	129.60 x	1.70
00752	95.83 x	105.13 x	2.70	CORT	104.80 x	— x	3.20	01409	120.00 x	132.00 x	4.00
01551	96.00 x	102.60 x	2.00	00829	105.00 x	115.00 x	5.00	00742	120.00 x	133.00 x	6.50
USIN	96.00 x	105.50 x	16.00	USIN	105.10 x	112.00 x	1.00	01789	120.00 x	135.00 x	2.00
01073	96.00 x	108.00 x	1.80	00321	106.00 x	112.00 x	1.30	00426	120.00 x	140.00 x	2.00
00404	97.00 x	111.00 x	3.50	01086	106.00 x	114.00 x	2.00	01345	120.50 x	126.50 x	3.20
00757	97.00 x	121.00 x	8.00	01825	106.00 x	127.00 x	9.00	USIN	121.00 x	125.00 x	10.00
01501	97.60 x	110.20 x	1.50	00905	106.50 x	112.50 x	2.20	USIN	121.00 x	127.00 x	1.20
01726	98.00 x	104.00 x	6.00	01923	107.00 x	119.00 x	2.00	01020	121.00 x	131.00 x	5.00
00803	98.00 x	109.00 x	2.00	00178	107.55 x	114.30 x	3.17	01444	121.00 x	170.00 x	10.00
01202	98.00 x	115.00 x	10.00	00712	107.60 x	112.20 x	2.30	01197	121.31 x	130.66 x	2.00
USIN	98.30 x	105.00 x	6.00	00707	107.60 x	114.20 x	3.60	01542	121.50 x	140.00 x	12.70
01198	98.40 x	114.30 x	1.58	00186	107.95 x	112.71 x	2.00	USIN	121.60 x	127.00 x	15.00
00035	98.40 x	114.30 x	9.00	00283	108.00 x	123.00 x	8.50	01851	121.80 x	132.40 x	5.00
00169	98.42 x	117.47 x	7.00	USIN	108.40 x	115.50 x	6.00	01704	121.90 x	128.50 x	6.95
01205	98.43 x	108.00 x	1.58	00598	108.74 x	127.39 x	9.50	USIN	122.00 x	128.00 x	6.50
01557	98.50 x	108.50 x	1.30	01174	109.00 x	126.00 x	3.00	00154	122.00 x	135.00 x	6.00
01589	99.00 x	120.00 x	12.70	01837	110.00 x	116.20 x	1.40	01508	122.00 x	145.00 x	3.16
01794	100.00 x	103.00 x	5.50	00811	110.00 x	124.00 x	2.40	USIN	123.00 x	127.50 x	6.35
01612	100.00 x	104.00 x	6.50	01472	110.00 x	150.00 x	0.40	00325	123.00 x	131.00 x	3.00
USIN	100.00 x	106.00 x	1.20	00951	110.00 x	190.00 x	1.50	00744	123.00 x	133.00 x	6.50
01465	100.00 x	106.40 x	1.20	00952	110.00 x	204.00 x	1.50	01359	123.00 x	152.40 x	15.00
USIN	100.00 x	107.00 x	1.00	01142	110.20 x	120.20 x	3.50	00159	123.46 x	132.08 x	52.32
01352	100.00 x	107.60 x	3.00	02011	110.28 x	146.10 x	1.58	00199	123.82 x	142.87 x	9.52
00307	100.00 x	109.00 x	2.00	01464	110.30 x	121.50 x	2.00	00199	123.82 x	142.97 x	9.52
00546	100.00 x	114.00 x	2.00	01112	110.70 x	117.50 x	1.67	00826	124.00 x	131.00 x	1.00
00407	100.00 x	120.00 x	5.50	01816	111.00 x	118.00 x	1.50	02018	124.28 x	130.28 x	1.27
01391	100.00 x	152.00 x	4.00	00173	111.00 x	121.00 x	6.30	01993	124.70 x	171.30 x	26.50
00328	100.50 x	129.50 x	2.50	01845	111.00 x	121.00 x	7.00	USIN	125.00 x	130.00 x	6.50
01724	101.00 x	106.00 x	0.80	01659	111.00 x	122.00 x	5.00	00642	125.00 x	130.00 x	7.00
01615	101.00 x	109.50 x	1.50	01747	112.00 x	112.00 x	117.40	CORT	125.00 x	131.00 x	0.80
01615	101.00 x	109.50 x	1.50	00395	112.00 x	122.00 x	1.50	USIN	125.00 x	132.50 x	1.20
01057	101.20 x	107.50 x	1.19	USIN	112.00 x	124.60 x	3.00	01703	125.00 x	133.00 x	0.40
01530	101.20 x	108.00 x	2.00	01549	112.00 x	127.00 x	1.00	01778	125.00 x	133.00 x	2.00
00044	101.50 x	106.00 x	1.60	02005	112.70 x	118.30 x	7.00	01092	125.00 x	133.00 x	2.00
01917	101.50 x	157.80 x	1.80	00232	112.71 x	122.24 x	10.32	00957	125.00 x	135.00 x	2.00
01917	101.50 x	157.80 x	1.80	00991	113.00 x	120.00 x	3.30	00957	125.00 x	135.00 x	2.00
				01706	113.00 x	125.00 x	5.20	01241	125.00 x	135.00 x	5.00
				01868	113.00 x	127.00 x	9.50	00794	125.00 x	137.00 x	3.00
				00339	114.00 x	126.00 x	2.80	01835	125.00 x	158.00 x	3.00
				01173	114.30 x	124.00 x	4.85	01801	126.00 x	132.80 x	8.20
				00135	114.30 x	126.30 x	3.50	01028	126.00 x	136.00 x	1.50
				01604	114.30 x	127.00 x	6.35	01145	126.00 x	138.00 x	3.50
				00203	114.30 x	147.63 x	6.35	00709	126.00 x	1306.00 x	2.30
				00437	114.50 x	120.50 x	1.20	1258	126.40 x	135.80 x	2.00
				00437	114.50 x	120.50 x	1.20	01258	126.40 x	135.80 x	2.00
				USIN	115.00 x	123.00 x	7.90	00634	126.59 x	133.59 x	3.50
				00755	115.00 x	125.00 x	15.00	00657	126.60 x	132.64 x	1.20
				00332	115.00 x	127.00 x	2.90	00374	127.00 x	131.36 x	6.30

								INCOVE VEDAÇÕES LTDA.			
Código	Di x	De x	Ha1	Código	Di x	De x	Ha1	Código	Di x	De x	Ha1
01713	127.00 x	133.00 x	1.80	00532	139.70 x	159.00 x	50.80	00511	150.00 x	180.00 x	8.00
01636	127.00 x	135.00 x	1.80	00418	139.70 x	203.20 x	4.00	01186	150.00 x	212.00 x	3.00
01971	127.00 x	136.00 x	2.00	00379	139.70 x	203.20 x	6.35	00908	150.00 x	216.00 x	3.00
01117	127.00 x	143.00 x	3.00	00384	139.70 x	203.20 x	9.52	01760	150.00 x	220.00 x	5.00
01682	127.00 x	145.00 x	8.00	00380	139.70 x	203.20 x	11.11	USIN	151.00 x	160.20 x	9.00
01682	127.00 x	145.00 x	8.00	00386	139.70 x	203.20 x	12.70	01781	151.00 x	165.50 x	2.30
00853	127.00 x	146.10 x	9.52	00385	139.70 x	203.20 x	14.29	USIN	152.00 x	157.00 x	0.80
00796	127.00 x	157.00 x	1.00	00378	139.70 x	203.20 x	15.87	USIN	152.00 x	158.40 x	20.00
00197	127.00 x	160.14 x	6.35	00376	139.70 x	203.20 x	19.05	02014	152.00 x	160.60 x	2.50
00798	127.00 x	165.00 x	1.00	00377	139.70 x	203.20 x	25.40	00637	152.00 x	166.00 x	7.00
00646	128.00 x	140.00 x	3.00	00357	139.70 x	203.20 x	25.70	USIN	152.40 x	159.60 x	9.50
00828	128.00 x	142.70 x	7.00	00355	139.70 x	203.20 x	33.01	00869	152.40 x	179.38 x	6.35
00909	128.00 x	197.50 x	1.50	00356	139.70 x	203.20 x	35.33	01281	152.50 x	218.00 x	9.50
01632	128.30 x	140.30 x	3.00	00367	139.70 x	203.20 x	45.15	01339	153.20 x	160.20 x	3.70
01784	129.00 x	135.00 x	2.00	00364	139.70 x	203.20 x	45.55	01715	154.50 x	160.50 x	2.00
00963	129.00 x	135.00 x	10.00	00366	139.70 x	203.20 x	54.93	00692	154.50 x	161.50 x	4.50
USIN	130.00 x	137.00 x	2.00	00365	139.70 x	203.20 x	73.60	00475	155.00 x	175.00 x	3.00
01266	130.00 x	145.00 x	2.30	00411	140.00 x	147.00 x	3.70	01103	157.00 x	176.00 x	1.20
01293	130.00 x	150.00 x	3.00	00323	140.00 x	149.00 x	3.50	00416	157.00 x	184.00 x	6.00
00669	130.00 x	157.00 x	10.00	01522	140.00 x	150.00 x	2.10	01397	158.40 x	160.00 x	12.70
01392	130.00 x	188.00 x	4.00	01165	140.00 x	150.00 x	9.00	00305	158.75 x	177.80 x	15.87
01016	130.00 x	210.00 x	30.00	01654	140.00 x	152.00 x	2.50	00180	158.80 x	170.90 x	10.00
USIN	130.30 x	136.70 x	1.60	00327	140.00 x	152.00 x	2.90	01405	159.70 x	175.10 x	0.50
00992	131.00 x	141.00 x	2.00	00362	140.00 x	160.00 x	3.00	USIN	160.00 x	164.00 x	3.50
00758	131.47 x	143.45 x	3.20	00939	140.00 x	160.00 x	10.00	01403	160.00 x	166.00 x	1.40
01910	131.57 x	177.80 x	3.17	00479	140.00 x	168.00 x	1.50	01718	160.00 x	168.00 x	1.50
01207	132.00 x	138.40 x	15.85	00417	140.00 x	170.00 x	2.00	USIN	160.00 x	169.00 x	0.80
01360	132.00 x	152.40 x	15.00	01797	140.49 x	152.40 x	2.78	01166	160.00 x	170.00 x	9.00
01434	133.00 x	140.00 x	2.00	00347	140.50 x	147.50 x	2.20	USIN	160.00 x	176.00 x	2.00
00889	133.00 x	143.00 x	3.00	00442	141.00 x	153.00 x	3.00	01888	160.00 x	180.40 x	3.00
00714	133.35 x	139.70 x	3.17	01987	141.00 x	192.00 x	2.00	00756	160.00 x	180.40 x	3.00
USIN	133.40 x	139.00 x	4.70	01558	141.30 x	151.30 x	1.30	01143	160.00 x	193.00 x	12.00
01383	133.50 x	157.00 x	15.00	00614	142.00 x	156.00 x	8.00	01039	160.00 x	218.00 x	3.17
01250	134.00 x	150.00 x	2.50	01861	142.00 x	187.00 x	15.00	01720	163.00 x	169.50 x	3.50
01061	134.40 x	145.40 x	3.80	01218	142.50 x	152.50 x	12.70	01891	164.90 x	171.45 x	3.53
01208	135.00 x	138.60 x	4.00	00697	142.50 x	156.00 x	3.50	00586	165.00 x	171.60 x	3.20
01209	135.00 x	139.60 x	4.00	00450	142.87 x	150.00 x	10.00	01961	165.00 x	172.00 x	10.00
00295	135.00 x	148.00 x	5.00	00018	142.87 x	184.15 x	31.75	00490	165.00 x	174.50 x	5.95
01144	135.00 x	164.00 x	10.50	00724	143.00 x	220.00 x	4.80	00002	165.00 x	180.00 x	3.00
01446	135.50 x	147.50 x	3.00	01776	143.50 x	173.50 x	15.00	01267	165.00 x	185.00 x	2.30
01773	136.50 x	144.50 x	2.00	00236	145.00 x	150.00 x	6.20	01373	165.71 x	177.69 x	2.44
00454	136.50 x	146.00 x	1.80	01683	145.00 x	151.50 x	27.00	00022	166.00 x	183.00 x	3.20
00346	137.60 x	144.60 x	1.50	01653	145.00 x	152.00 x	3.50	01960	166.00 x	185.00 x	6.00
USIN	138.90 x	144.90 x	12.50	USIN	145.00 x	152.00 x	9.50	01631	166.00 x	185.00 x	7.00
01447	139.00 x	151.00 x	3.00	00554	145.00 x	152.00 x	9.50	00015	166.50 x	186.50 x	3.17
00308	139.60 x	151.20 x	2.80	01684	145.00 x	152.50 x	9.30	USIN	167.00 x	174.60 x	2.00
00231	139.70 x	149.22 x	3.17	01829	145.00 x	157.70 x	2.00	00509	167.00 x	175.00 x	2.80
00519	139.70 x	159.00 x	6.35	00006	145.00 x	170.00 x	4.50	00673	167.00 x	177.00 x	3.00
00520	139.70 x	159.00 x	9.52	00588	145.00 x	355.00 x	2.00	00510	168.00 x	193.40 x	6.00
00521	139.70 x	159.00 x	11.11	01681	146.00 x	153.00 x	1.25	01854	168.00 x	210.00 x	15.00
00522	139.70 x	159.00 x	12.70	01681	146.00 x	153.00 x	1.25	00555	168.27 x	222.25 x	23.81
00523	139.70 x	159.00 x	14.28	01182	146.00 x	160.00 x	3.00	00451	169.00 x	181.00 x	4.00
00524	139.70 x	159.00 x	15.87	00012	146.05 x	152.40 x	1.78	01989	169.00 x	218.00 x	2.00
00534	139.70 x	159.00 x	19.05	01916	146.12 x	158.75 x	6.70	01719	169.50 x	176.80 x	3.70
00537	139.70 x	159.00 x	25.40	01737	146.75 x	153.00 x	2.00	01076	170.00 x	176.00 x	1.70
				00298	147.00 x	153.00 x	6.00	01087	170.00 x	178.40 x	3.80
				01291	147.00 x	157.00 x	5.20	01077	170.00 x	180.00 x	2.50
				01922	147.00 x	159.00 x	12.00	01559	170.00 x	180.00 x	4.00
				01571	147.00 x	160.00 x	2.50	00602	170.00 x	184.00 x	6.00
				00568	147.35 x	159.33 x	2.97	01151	170.00 x	200.00 x	3.00
				01394	149.00 x	155.00 x	10.00	01913	170.00 x	208.00 x	15.00
				01532	150.00 x	155.00 x	2.00	01560	170.50 x	175.50 x	3.50
				USIN	150.00 x	158.00 x	8.00	01561	170.50 x	179.30 x	3.50
				00597	150.00 x	160.00 x	5.00	01625	170.82 x	182.22 x	3.00
				01717	150.00 x	160.00 x	9.00	01894	171.45 x	178.13 x	3.53
				....	150.00 x	170.00 x	10.00	00833	171.50 x	177.80 x	1.50
				02004	150.00 x	175.00 x	3.00	00848	171.50 x	178.60 x	3.40

								INCOLVE VEDAÇÕES LTDA.			
Código	Di x	De x	Ha1	Código	Di x	De x	Ha1	Código	Di x	De x	Ha1
00659	172.00	x	180.00	x	23.00	00907	203.00	x	213.00	x	2.00
01545	172.00	x	184.00	x	0.75	00976	203.00	x	290.00	x	16.00
01507	172.00	x	190.00	x	4.70	01152	203.00	x	290.00	x	16.00
01950	172.20	x	174.90	x	2.60	00728	203.81	x	475.00	x	5.90
USIN	174.00	x	190.00	x	2.00	00271	205.00	x	217.00	x	23.00
01856	174.00	x	216.00	x	12.00	01093	205.50	x	218.50	x	4.50
00842	175.00	x	191.00	x	3.00	00041	206.00	x	218.00	x	2.30
01826	175.00	x	203.00	x	26.00	00041	206.00	x	218.00	x	2.30
01815	175.00	x	205.30	x	26.00	01946	209.00	x	223.00	x	7.00
01543	176.00	x	188.00	x	2.00	00946	210.00	x	223.00	x	6.50
01519	176.00	x	188.00	x	2.20	01833	210.00	x	225.00	x	3.00
USIN	176.00	x	200.00	x	3.00	00988	210.00	x	290.00	x	7.00
01721	176.50	x	183.80	x	3.50	00007	212.72	x	246.06	x	1.59
01714	176.60	x	182.60	x	1.60	00014	215.00	x	225.00	x	2.40
00164	177.80	x	185.00	x	3.20	00008	215.00	x	228.00	x	7.80
00961	178.00	x	202.00	x	3.70	01056	215.00	x	275.00	x	2.00
01630	178.70	x	185.00	x	5.00	01884	215.10	x	264.00	x	1.50
01767	179.00	x	185.00	x	1.50	00409	216.00	x	228.00	x	3.00
00300	179.00	x	186.00	x	3.00	00967	216.50	x	228.50	x	3.00
00556	180.00	x	200.00	x	6.00	00969	220.00	x	250.00	x	3.00
01242	181.00	x	210.00	x	5.50	01988	220.00	x	273.00	x	2.00
01502	182.00	x	194.00	x	5.00	00959	220.00	x	275.00	x	3.17
01172	184.00	x	196.60	x	7.00	00370	222.00	x	289.00	x	20.00
USIN	184.50	x	190.50	x	8.00	01966	222.30	x	231.90	x	3.50
00930	185.00	x	195.00	x	3.50	01130	224.00	x	254.00	x	1.00
00601	185.00	x	203.00	x	6.00	00294	224.80	x	239.00	x	2.00
00017	185.00	x	217.00	x	11.00	00603	225.00	x	267.00	x	8.00
00005	186.00	x	198.00	x	10.00	01795	225.00	x	330.00	x	5.00
01265	186.30	x	203.00	x	8.10	00704	226.30	x	238.31	x	2.66
01514	187.00	x	203.20	x	2.50	01791	227.50	x	239.10	x	3.00
00623	187.00	x	220.00	x	13.00	01898	228.50	x	261.50	x	16.00
01903	188.00	x	218.00	x	25.00	01899	228.60	x	355.60	x	3.20
00188	188.91	x	225.42	x	7.94	01899	228.60	x	355.60	x	3.20
00335	189.00	x	219.00	x	4.00	USIN	230.00	x	250.00	x	5.00
01078	190.00	x	199.00	x	2.20	01203	231.77	x	282.57	x	25.40
00761	190.00	x	200.00	x	6.00	01806	236.50	x	253.50	x	25.20
00884	190.00	x	206.00	x	3.50	01827	245.00	x	256.00	x	2.00
USIN	190.00	x	215.00	x	10.00	00645	245.00	x	280.00	x	8.50
00839	190.00	x	230.00	x	3.00	00434	252.00	x	265.00	x	5.00
01055	190.00	x	245.00	x	2.00	01233	254.00	x	272.00	x	0.50
01193	190.30	x	203.40	x	7.20	00759	254.60	x	266.59	x	0.50
01562	190.50	x	198.50	x	3.50	00427	254.60	x	266.59	x	5.99
00011	192.00	x	206.00	x	3.17	01220	256.00	x	266.00	x	2.00
01477	193.00	x	205.00	x	3.00	01136	256.50	x	276.20	x	1.75
01155	194.00	x	205.00	x	5.50	00020	257.00	x	283.80	x	12.50
01990	195.00	x	248.00	x	2.00	00309	258.50	x	264.50	x	3.50
01869	196.00	x	225.00	x	1.00	01353	261.80	x	270.00	x	2.00
01965	197.00	x	205.00	x	3.50	00010	262.00	x	270.00	x	2.70
01897	197.50	x	202.90	x	1.80	01147	274.00	x	288.50	x	6.30
00016	199.00	x	217.00	x	9.00	02012	275.00	x	329.00	x	2.00
01478	200.00	x	208.00	x	4.00	02006	280.00	x	284.00	x	2.00
00336	200.00	x	230.00	x	15.00	00584	280.00	x	310.00	x	4.40
01239	202.57	x	216.60	x	2.30	00359	280.01	x	291.99	x	2.97
00023	203.00	x	213.00	x	2.00	01838	283.00	x	462.00	x	3.50
00671	288.50	x	298.50	x	4.30	00348	300.83	x	307.97	x	3.57
01949	290.00	x	310.00	x	3.20	01624	304.17	x	316.87	x	3.00
00513	290.00	x	320.00	x	8.00	01660	305.00	x	335.00	x	7.50
00694	290.50	x	304.50	x	14.00	01063	307.00	x	315.00	x	3.00
00104	293.00	x	312.00	x	6.00	01768	308.00	x	320.00	x	1.30
00304	293.00	x	320.00	x	14.00	00441	310.00	x	350.00	x	2.50
00348	300.83	x	307.97	x	3.57	00589	315.00	x	355.00	x	2.00
01624	304.17	x	316.87	x	3.00	00478	315.00	x	357.00	x	1.50
01660	305.00	x	335.00	x	7.50	01010	325.00	x	350.00	x	16.00
01063	307.00	x	315.00	x	3.00	00970	325.00	x	365.00	x	3.00
01768	308.00	x	320.00	x	1.30	01408	329.57	x	343.55	x	3.00
00441	310.00	x	350.00	x	2.50	00827	330.00	x	350.00	x	2.00
00589	315.00	x	355.00	x	2.00	01195	330.00	x	375.00	x	3.50
00478	315.00	x	357.00	x	1.50	01893	332.50	x	483.00	x	3.20
01010	325.00	x	350.00	x	16.00	01893	332.50	x	483.00	x	3.20
00970	325.00	x	365.00	x	3.00	01524	335.00	x	408.00	x	2.50
01408	329.57	x	343.55	x	3.00	00473	336.00	x	380.00	x	10.00
00827	330.00	x	350.00	x	2.00	00620	345.00	x	383.00	x	11.00
01195	330.00	x	375.00	x	3.50	01247	354.90	x	365.50	x	2.00
01893	332.50	x	483.00	x	3.20	01627	354.97	x	366.97	x	3.00
01893	332.50	x	483.00	x	3.20	01823	357.00	x	703.00	x	10.00
01524	335.00	x	408.00	x	2.50	USIN	360.00	x	400.00	x	3.00
00473	336.00	x	380.00	x	10.00	00009	363.00	x	368.40	x	2.00
00620	345.00	x	383.00	x	11.00	00498	363.00	x	460.00	x	2.40
01247	354.90	x	365.50	x	2.00	01188	365.00	x	400.00	x	17.60
01627	354.97	x	366.97	x	3.00	01067	381.00	x	393.60	x	6.30
01823	357.00	x	703.00	x	10.00	00019	385.00	x	406.00	x	10.00
USIN	360.00	x	400.00	x	3.00	00360	394.31	x	406.29	x	2.97
00009	363.00	x	368.40	x	2.00	00701	398.40	x	409.90	x	6.00
00498	363.00	x	460.00	x	2.40	00971	400.00	x	430.00	x	3.00
01188	365.00	x	400.00	x	17.60	01042	402.00	x	420.00	x	7.00
01067	381.00	x	393.60	x	6.30	01164	405.00	x	420.00	x	7.00
00019	385.00	x	406.00	x	10.00	01043	410.00	x	440.00	x	11.50
00360	394.31	x	406.29	x	2.97	01104	422.00	x	438.20	x	8.20
00701	398.40	x	409.90	x	6.00	01766	428.80	x	567.80	x	3.20
00971	400.00	x	430.00	x	3.00	01221	435.00	x	455.00	x	15.00
01042	402.00	x	420.00	x	7.00	CORT	435.00	x	560.00	x	5.00
01164	405.00	x	420.00	x	7.00	00013	455.00	x	465.00	x	4.00
01043	410.00	x	440.00	x	11.50	CORT	480.00	x	580.00	x	6.00
01104	422.00	x	438.20	x	8.20	01626	494.16	x	506.16	x	3.00
01766	428.80	x	567.80	x	3.20	01765	505.00	x	638.00	x	3.20
01221	435.00	x	455.00	x	15.00	01668	514.00	x	542.00	x	20.00
CORT	435.00	x	560.00	x	5.00	01223	625.00	x	645.00	x	15.00
00013	455.00	x	465.00	x	4.00	01370	629.00	x	645.00	x	10.00
CORT	480.00	x	580.00	x	6.00	00972	669.00	x	710.00	x	3.00
01626	494.16	x	506.16	x	3.00	CORT	725.00	x	1075.00	x	5.00
01765	505.00	x	638.00	x	3.20	CORT	725.00	x	1075.00	x	5.00
01668	514.00	x	542.00	x	20.00	01041	800.00	x	807.00	x	2.20
01223	625.00	x	645.00	x	15.00						
01370	629.00	x	645.00	x	10.00						
00972	669.00	x	710.00	x	3.00						
CORT	725.00	x	1075.00	x	5.00						
CORT	725.00	x	1075.00	x	5.00						
01041	800.00	x	807.00	x	2.20						

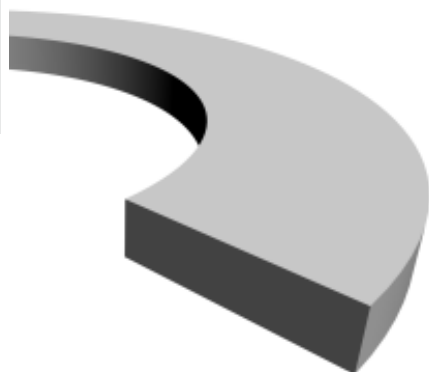







INCOVE VEDAÇÕES LTDA.

**BUchas**



Código	Di x	De x	Esp. x	Ha1
F12445	3.17 x	14.28 x	— x	19.05
F9002	4.50 x	24.50 x	— x	20.00
F2902	5.00 x	16.50 x	— x	7.00
F12221	5.70 x	11.00 x	— x	11.00
F1045	6.00 x	11.00 x	— x	12.50
F13800	6.00 x	13.00 x	— x	11.00
F1045	6.30 x	12.00 x	— x	11.00
F11647	6.30 x	31.00 x	— x	25.00
F3038	6.35 x	31.75 x	— x	127.00
F12948	7.80 x	20.00 x	— x	15.00
F2829	8.00 x	18.00 x	— x	14.00
F2477	8.50 x	15.80 x	— x	8.50
F8995	9.00 x	13.00 x	45.00 x	4.00
F13523	9.00 x	13.50 x	— x	8.00
F1129	9.00 x	23.20 x	— x	9.00
F1578	9.00 x	23.20 x	— x	9.00
F2257/B	9.52 x	12.70 x	— x	6.35
F2232	10.00 x	14.50 x	— x	12.50
F7211	10.00 x	15.50 x	— x	10.00
USIN	10.00 x	18.00 x	— x	14.77
F16635	10.00 x	25.00 x	— x	35.00
F16779	10.30 x	14.40 x	— x	6.00
F1271	10.70 x	12.70 x	— x	100.00
F7319	11.00 x	20.00 x	— x	20.00
F3814	11.00 x	20.50 x	— x	15.00
F5375	11.00 x	30.00 x	— x	46.00
F3792	11.00 x	35.00 x	— x	22.00
F13131	11.80 x	22.00 x	— x	13.20
USIN	12.00 x	21.00 x	— x	14.50
F54	12.00 x	24.00 x	— x	20.00
F10385	12.00 x	25.00 x	— x	25.00
F53	12.00 x	30.00 x	— x	25.00
F472	12.00 x	38.00 x	— x	41.00
F5388	12.00 x	46.00 x	— x	50.00
F929	12.20 x	26.00 x	— x	13.20
USIN	12.50 x	34.00 x	— x	50.00
F1089	12.70 x	15.00 x	— x	100.00
USIN	12.70 x	15.87 x	— x	14.29
F9161	12.70 x	16.00 x	— x	12.70
F11252	12.70 x	19.05 x	— x	17.00
F6448	12.70 x	25.40 x	— x	23.88
F8404	12.70 x	34.50 x	— x	12.00
F13185	12.70 x	63.50 x	— x	19.50
F12953	12.80 x	16.00 x	— x	16.00
F149	13.00 x	22.00 x	— x	19.00
—	13.00 x	25.00 x	— x	20.00
F124	13.00 x	30.00 x	— x	36.50
F3815	13.00 x	35.00 x	— x	22.00
F8998	13.00 x	35.00 x	— x	85.00
F2900	13.97 x	36.77 x	— x	12.80
F1043	14.00 x	21.50 x	— x	15.00
—	14.00 x	22.00 x	— x	15.00
F992	14.00 x	26.40 x	— x	14.50
F11873	14.00 x	32.10 x	— x	15.10
F9397	14.50 x	33.50 x	— x	35.00

Código	Di x	De x	Esp. x	Ha1
F2257/	14.80 x	19.00 x	— x	9.00
F13736	15.00 x	21.00 x	— x	15.00
F3750	15.00 x	24.00 x	— x	11.00
F10367	15.00 x	25.00 x	— x	25.00
F3557	15.00 x	25.00 x	23.50 x	27.00
F3558	15.00 x	30.00 x	25.00 x	32.00
F3791	15.00 x	35.00 x	— x	22.00
F.....	15.00 x	60.00 x	— x	25.00
F3777	15.50 x	22.00 x	— x	10.00
F1123	15.87 x	25.40 x	— x	20.00
F1780	15.87 x	28.57 x	— x	31.75
F12978	16.00 x	19.00 x	— x	26.50
F972	16.00 x	24.00 x	— x	30.00
F1058	16.00 x	28.00 x	— x	90.00
F4506	16.00 x	29.00 x	— x	35.00
F14423	16.00 x	70.00 x	— x	90.00
F10624	16.50 x	27.00 x	— x	20.50
F1434	17.00 x	25.00 x	— x	14.00
F3816	17.00 x	26.00 x	— x	15.00
F4971	17.00 x	30.50 x	— x	11.00
F4278	17.00 x	35.00 x	— x	22.00
F1035	17.00 x	50.00 x	— x	32.00
F1238	18.00 x	29.00 x	— x	28.00
F15658	18.00 x	30.00 x	— x	22.60
F10092	18.00 x	30.00 x	— x	28.00
F12537	18.00 x	34.00 x	— x	42.00
F4187	18.00 x	35.00 x	— x	27.00
F2934	18.00 x	38.00 x	— x	33.00
F6226	18.50 x	25.40 x	— x	12.80
F4040	19.00 x	26.00 x	— x	15.00
F13186	19.00 x	41.00 x	— x	26.00
F3818	19.00 x	52.00 x	— x	22.00
F1041	19.05 x	28.57 x	— x	20.00
F13505	20.00 x	29.00 x	6.00 x	24.00
F1711	20.00 x	30.00 x	— x	30.00
F6304	20.00 x	32.00 x	— x	45.00
F10197	20.00 x	35.00 x	— x	37.00
USIN	20.00 x	35.00 x	— x	100.00
F530	20.00 x	40.00 x	— x	36.00
F.....	20.00 x	44.00 x	42.00 x	38.00
IS2106	20.00 x	47.00 x	36.00 x	43.00
F6383	20.00 x	70.00 x	— x	100.00
F1891	21.00 x	36.00 x	— x	36.00
F1879	22.00 x	33.00 x	— x	36.00
F2344	22.00 x	36.00 x	— x	30.00
F1417	22.00 x	44.00 x	— x	34.00
F12979	22.20 x	48.00 x	— x	45.00
F1917	22.22 x	36.51 x	— x	33.34
F3817	23.00 x	52.00 x	— x	22.00
F3790	23.00 x	52.00 x	— x	22.00
F13687	24.00 x	61.00 x	— x	38.00
F13687	24.00 x	61.00 x	— x	64.00
F1435	25.00 x	30.00 x	— x	18.00
F3238	25.00 x	40.00 x	— x	48.00
F43	25.00 x	44.50 x	— x	25.00
USIN	25.40 x	38.00 x	— x	110.00
F3398	25.40 x	38.10 x	— x	33.34
F10658	25.40 x	42.00 x	20.00 x	7.00
F297	25.40 x	46.00 x	— x	25.40
F4847	25.40 x	46.02 x	— x	19.05
F15982	26.00 x	44.00 x	— x	4.00
F3832	27.00 x	52.00 x	— x	22.00
F12413	27.50 x	36.50 x	— x	16.00
F13654	29.60 x	46.00 x	— x	28.00
F2714	30.00 x	40.00 x	— x	45.00
F15577	30.00 x	60.00 x	— x	35.00
F1828	30.00 x	60.00 x	— x	51.00

Código	Di x	De x	Esp. x	Ha1
F6192	30.00 x	60.00 x	— x	100.00
F.....	30.00 x	80.00 x	— x	100.00
F5139	30.00 x	90.00 x	— x	100.00
F15547	30.60 x	46.00 x	— x	28.00
F917	31.70 x	45.00 x	— x	23.00
F917	31.75 x	44.45 x	— x	23.00
USIN	32.00 x	39.00 x	— x	27.00
F6855	32.00 x	55.00 x	— x	45.00
F14883	32.00 x	60.00 x	— x	30.00
F11937	33.00 x	55.00 x	— x	11.11
F6305	33.00 x	55.00 x	— x	35.00
F14206	33.00 x	55.20 x	— x	30.00
F1575	33.50 x	55.50 x	— x	51.50
F12313	34.00 x	51.00 x	— x	16.00
F3789	34.00 x	60.00 x	— x	22.00
F10380	34.50 x	58.50 x	— x	20.00
F11281	34.58 x	58.50 x	— x	20.00
F2038	34.92 x	50.80 x	— x	44.45
F5861	35.00 x	48.00 x	— x	17.40
F2005	35.00 x	50.00 x	— x	55.00
USIN	35.00 x	50.00 x	— x	100.00
USIN	35.00 x	60.00 x	— x	120.00
F13937	35.00 x	90.00 x	— x	76.00
F4139	36.00 x	60.00 x	— x	22.00
USIN	36.00 x	70.00 x	— x	100.00
USIN	37.00 x	70.00 x	— x	110.00
F4836	38.00 x	76.00 x	— x	40.00
F5795	38.50 x	75.50 x	— x	50.00
F15884	38.80 x	26.00 x	— x	25.50
USIN	40.00 x	55.00 x	— x	60.00
USIN	40.00 x	55.00 x	— x	100.00
USIN	40.00 x	65.00 x	— x	100.00
F.....	40.00 x	120.00 x	— x	140.00
F9984	41.00 x	63.00 x	— x	25.00
F13682	41.00 x	99.80 x	— x	74.00
F2730	41.27 x	49.21 x	— x	88.90
F13415	43.00 x	76.50 x	— x	23.00
F12632	43.00 x	77.00 x	— x	16.00
F15521	45.00 x	73.00 x	— x	50.00
F4924	45.00 x	270.00 x	— x	105.00
F6372	49.00 x	80.00 x	— x	26.00
USIN	50.00 x	65.00 x	— x	100.00
USIN	50.00 x	65.00 x	— x	120.00
USIN	50.00 x	70.00 x	— x	100.00
F6063	50.00 x	90.00 x	— x	65.00
F17116	50.00 x	130.00 x	— x	140.00
F14296	50.00 x	136.00 x	— x	30.00
F7835	50.00 x	150.00 x	— x	27.00
—	50.80 x	0.00 x	100.00 x	0.00
F9982	51.00 x	76.00 x	— x	25.00
F4835	52.50 x	70.00 x	— x	17.00
F12646	54.00 x	128.50 x	— x	35.50
F12646	54.00 x	128.50 x	— x	35.50
USIN	60.00 x	70.00 x	— x	120.00
USIN	60.00 x	80.00 x	— x	100.00
USIN	60.00 x	80.00 x	— x	100.00
F7278	60.00 x	100.00 x	— x	145.00
F13419	61.50 x	101.00 x	— x	22.00
USIN	65.00 x	80.00 x	— x	50.00
USIN	65.00 x	80.00 x	— x	100.00
USIN	65.00 x	80.00 x	— x	115.00
F71	70.00 x	73.00 x	— x	30.00
USIN	75.00 x	50.80 x	— x	100.00
F9814	76.00 x	102.00 x	— x	152.00
F12543	78.00 x	83.00 x	— x	42.00
F4600	78.00 x	84.00 x	— x	42.40
F17105	78.60 x	99.10 x	— x	21.50



# Buchas



INCOVE VEDAÇÕES LTDA.

Código	Di x	De x	Esp. x	Ha1
USIN	80.00	x100.00	x	— x100.00
USIN	80.00	x110.00	x	— x 25.00
F334	80.00	x160.00	x	— x 40.00
USIN	85.00	x100.00	x	— x100.00
USIN	85.00	x100.00	x	— x110.00
USIN	85.00	x105.00	x	— x150.00
USIN	90.00	x105.00	x	— x100.00
USIN	90.00	x125.00	x	— x 25.00
F12643	90.00	x152.00	x	— x 30.00
USIN	91.00	x 75.00	x	— x 50.00
F10912	92.00	x102.00	x	— x 24.00
USIN	94.00	x115.00	x	— x 50.00
USIN	95.00	x106.00	x	— x150.00
USIN	95.00	x125.00	x	— x 20.00
USIN	95.00	x125.00	x	— x 25.00
F12781	95.00	x130.00	x	— x 38.00
USIN	95.00	x135.00	x	— x 20.00
F15525	95.00	x150.00	x	— x 38.00
F12781/	96.00	x151.00	x	— x 38.00
USIN	100.00	x120.00	x	— x100.00
F12255	100.00	x150.00	x	— x 39.00
F15537	100.00	x150.00	x	— x 39.00
USIN	105.00	x135.00	x	— x 20.00

Código	Di x	De x	Esp. x	Ha1
USIN	110.00	x135.00	x	— x 15.00
USIN	110.00	x135.00	x	— x 20.00
F11541	113.00	x168.00	x	— x 27.80
USIN	115.00	x135.00	x	— x110.00
USIN	115.00	x135.00	x	— x120.00
USIN	120.00	x155.00	x	— x 25.00
USIN	125.00	x145.00	x	— x 7.00
USIN	125.00	x145.00	x	— x100.00
F8594	125.00	x165.00	x	— x100.00
F9794	127.00	x178.00	x	— x254.00
USIN	130.00	x140.00	x	— x100.00
USIN	130.00	x160.00	x	— x 18.00
USIN	130.00	x160.00	x	— x 25.00
USIN	135.00	x170.00	x	— x120.00
USIN	135.00	x180.00	x	— x 15.00
USIN	135.00	x180.00	x	— x 25.00
F12747	137.00	x153.00	x	— x 26.00
USIN	150.00	x165.00	x	— x100.00
USIN	150.00	x165.00	x	— x100.00
USIN	155.00	x180.00	x	— x 20.00
USIN	160.00	x165.00	x	— x 14.80
USIN	160.00	x175.00	x	— x150.00
USIN	160.00	x185.00	x	— x 15.00

Código	Di x	De x	Esp. x	Ha1
USIN	160.00	x185.00	x	— x 20.00
USIN	160.00	x185.00	x	— x100.00
USIN	165.00	x195.00	x	— x 15.00
USIN	170.00	x180.00	x	— x100.00
USIN	170.00	x205.00	x	— x 25.00
USIN	180.00	x220.00	x	— x 40.00
USIN	200.00	x235.00	x	— x 20.00
USIN	200.00	x235.00	x	— x 25.00
USIN	230.00	x265.00	x	— x 40.00
USIN	240.00	x295.00	x	— x 50.00
USIN	240.00	x300.00	x	— x 25.00
F13653	250.00	x285.00	x	— x 19.05
USIN	280.00	x230.00	x	— x 35.00
USIN	345.00	x385.00	x	— x 30.00
USIN	345.00	x390.00	x	— x 40.00
USIN	345.00	x405.00	x	— x 50.00
USIN	347.00	x405.00	x	— x 40.00
USIN	350.00	x410.00	x	— x 50.00
USIN	355.00	x405.00	x	— x 50.00
USIN	360.00	x400.00	x	— x 10.00
USIN	400.00	x300.00	x	— x150.00

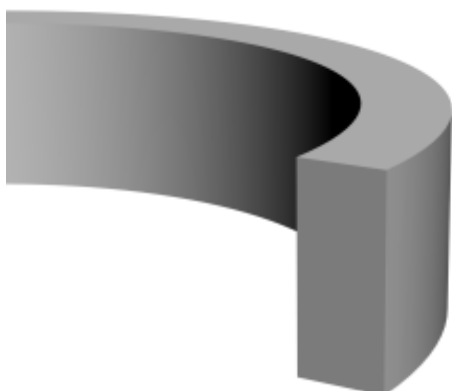







# Limpadores

Sem chapa de aço

# RAspadores

Com chapa de aço

**INCOVE**<sup>®</sup>

INCOVE VEDAÇÕES LTDA.

**Limpadores**  
**RAspadores**



## Raspadores e Limpadores

Os raspadores constituem uma classe especial de vedadores, usados normalmente mais por sua ação de raspagem combinada com movimentos deslizantes ou alternativos do que propriamente como elementos de vedação, embora possam desenvolver também uma eficiente ação de selagem. Sua função normal é a remoção de poeira, sujeira e partículas semelhantes de uma superfície que passa sob eles e assim oferecer proteção para superfícies interiores de uma máquina.

Provavelmente a aplicação mais conhecida é o raspador de haste, que evita a introdução de matéria estranha no interior de um cilindro pneumático ou hidráulico por intermédio da haste, durante o curso de entrada; o raspador assume, nesse caso, a forma de um anel que circunda a haste. Em tais casos, o raspador é usado simplesmente como um dispositivo de proteção e qualquer vedação da haste eventualmente necessária será realizada por um vedador de haste ou de alojamento separado. Em outras aplicações, podem ser previstos raspadores para percorrer superfícies planas ou curvas, usando-se então lâminas retas ou perfiladas respectivamente, ainda aqui com a finalidade de remover impurezas superficiais. O princípio de trabalho é o mesmo, embora a seção e a forma de construção do raspador possam diferir sensivelmente.

Os dispositivos de limpeza de hastes podem, portanto, ser considerados tanto como anéis raspadores de ação suave (wiper rings) quanto como anéis raspadores de ação vigorosa (scraper rings), dependendo de sua construção e forma de ação; alguns podem combinar as duas ações de raspagem vigorosa e de vedação. Além disso, eles podem também ser designados como vedadores raspadores, embora destinados a servir antes como dispositivos de proteção que como dispositivos de vedação. O que é normalmente necessário é que a forma do raspador evite o acúmulo de partículas em torno e por baixo do mesmo. Os raspadores não se destinam ao duplo papel de proteção e vedação de hastes. Para esta última função, usa-se invariavelmente um vedador separado.





Código	Di x	De x	Ha1 x	Ha2
F14958	25.00 x	32.00 x	5.00 x	8.00
F16953	25.00 x	32.50 x	7.00 x	8.00
F10739	25.00 x	33.00 x	3.50 x	7.00
F13278	25.00 x	33.00 x	3.50 x	7.00
F13692	25.00 x	33.00 x	3.50 x	7.00
F2564	25.00 x	33.00 x	4.00 x	8.00
F11409	25.00 x	33.00 x	4.00 x	8.00
F2564	25.00 x	33.00 x	4.00 x	8.00
F9092	25.00 x	33.00 x	5.00 x	7.00
USIN	25.00 x	33.00 x	5.00 x	7.00
F4111	25.00 x	33.50 x	5.00 x	7.00
F15805	25.00 x	34.00 x	3.50 x	5.25
F6220/2	25.00 x	34.00 x	5.00 x	8.00
F12259	25.00 x	35.00 x	3.00 x	7.00
F12721	25.00 x	35.15 x	7.00 x	10.00
F438	25.00 x	37.50 x	3.00 x	8.00
F14141	25.00 x	40.00 x	5.00 x	7.00
F7701	25.00 x	50.00 x	2.80 x	10.00
F11235	25.40 x	31.10 x	2.30 x	3.00
F10454	25.40 x	31.40 x	3.00 x	4.00
F10454	25.40 x	31.40 x	3.00 x	4.00
F10454	25.40 x	31.40 x	3.00 x	4.00
F6119/2	25.40 x	31.50 x	2.50 x	3.50
F13377	25.40 x	31.70 x	3.00 x	5.00
F3631	25.40 x	31.75 x	3.17 x	3.97
F5556	25.40 x	32.50 x	1.00 x	3.00
F9470	25.40 x	32.54 x	2.62 x	3.57
USIN	25.40 x	33.10 x	6.35 x	9.52
F3624	25.40 x	33.34 x	4.37 x	7.94
F8476	25.40 x	34.50 x	6.50 x	9.00
F7155	25.40 x	34.90 x	4.75 x	7.70
F13840	25.40 x	34.90 x	4.75 x	7.14
F13840	25.40 x	34.90 x	4.76 x	7.14
F7462	25.40 x	34.90 x	5.00 x	6.30
F14636	25.40 x	34.90 x	6.35 x	8.50
F9109	25.40 x	34.90 x	8.00 x	9.60
F5879	25.40 x	34.92 x	4.76 x	6.35
F13840	25.40 x	34.92 x	4.76 x	6.35
F10158	25.40 x	34.92 x	5.56 x	7.14
F14810	25.40 x	35.20 x	7.00 x	12.00
F11488	25.40 x	38.10 x	3.57 x	6.35
F607	25.40 x	41.00 x	2.50 x	7.20
F4057	25.40 x	41.27 x	2.38 x	7.14
F3423	25.40 x	41.27 x	2.38 x	6.35
F2436	25.40 x	41.27 x	3.50 x	11.11
F15674	25.70 x	33.00 x	5.00 x	7.00
F2853	26.00 x	31.30 x	3.00 x	4.00
F3754	26.00 x	32.00 x	2.50 x	4.50
F2156	26.00 x	35.00 x	5.00 x	7.50
F4131	26.00 x	37.00 x	6.00 x	8.50
USIN	26.10 x	34.80 x	4.00 x	7.50
F14321	26.50 x	35.50 x	4.50 x	7.50
F14769	26.50 x	39.80 x	1.90 x	4.00
F11814	26.80 x	34.90 x	2.90 x	3.80
USIN	26.99 x	36.51 x	4.76 x	7.14

Código	Di x	De x	Ha1 x	Ha2
F17122	28.00 x	33.30 x	3.00 x	4.00
F5753	28.00 x	36.00 x	3.50 x	7.50
F9839	28.00 x	36.00 x	4.00 x	7.00
F4361	28.00 x	36.00 x	5.00 x	7.00
F6202/1	28.00 x	36.00 x	5.00 x	7.00
USIN	28.00 x	36.00 x	5.00 x	7.00
F14245	28.00 x	37.00 x	5.00 x	6.50
USIN	28.00 x	43.00 x	5.00 x	7.00
F2689	28.00 x	49.50 x	13.00 x	0.00
F5360	28.00 x	61.50 x	5.00 x	15.00
F15602	28.50 x	35.00 x	1.50 x	2.00
USIN	28.50 x	40.00 x	1.30 x	0.00
F4085	28.57 x	46.02 x	3.17 x	4.76
F2688	28.57 x	50.80 x	3.17 x	6.35
F3473	28.57 x	50.80 x	3.17 x	7.14
F10547	28.58 x	37.31 x	3.00 x	5.50
F8636	28.58 x	38.10 x	4.56 x	7.19
F12224	29.00 x	37.00 x	5.00 x	3.20
USIN	29.00 x	40.00 x	1.30 x	2.50
F12935	30.00 x	37.50 x	4.00 x	7.30
F10564	30.00 x	38.00 x	4.00 x	7.00
F6913	30.00 x	38.00 x	5.00 x	7.00
F10351	30.00 x	38.00 x	5.00 x	7.00
F10351	30.00 x	38.00 x	5.00 x	7.00
F10351	30.00 x	38.00 x	5.00 x	7.00
F9490	30.00 x	38.00 x	7.00 x	10.00
F4423	30.00 x	39.00 x	4.50 x	7.00
F6391	30.00 x	40.00 x	3.00 x	7.00
F8291	30.00 x	40.00 x	5.00 x	8.00
F13872	30.00 x	40.00 x	7.00 x	10.00
F13381	30.00 x	40.00 x	7.00 x	11.00
F9415	30.00 x	43.00 x	7.50 x	8.00
USIN	30.00 x	44.50 x	2.00 x	7.00
USIN	30.00 x	44.50 x	34.00 x	39.00
F14926	30.00 x	45.00 x	5.00 x	9.00
F12712	30.00 x	48.00 x	2.50 x	9.00
F6936/1	30.09 x	37.24 x	2.64 x	3.10
F6936/1	30.09 x	37.24 x	2.64 x	3.10
USIN	30.16 x	37.61 x	2.62 x	3.57
F3364	30.16 x	38.10 x	5.00 x	7.14
F3364	30.16 x	38.10 x	5.00 x	7.14
USIN	30.16 x	38.89 x	2.62 x	3.57
F10889	30.16 x	39.69 x	4.76 x	7.14
F12120	31.00 x	38.00 x	2.50 x	5.00
F12120	31.00 x	38.00 x	2.50 x	5.00
F5959	31.00 x	38.00 x	5.00 x	7.00
F6736/1	31.00 x	41.50 x	5.00 x	7.00
F6713	31.00 x	41.50 x	5.00 x	7.00
F7929/2	31.00 x	44.00 x	3.00 x	6.50
F8701	31.50 x	41.50 x	4.50 x	6.50
F7675	31.50 x	42.40 x	8.40 x	0.00
F4293	31.75 x	38.10 x	2.00 x	3.57
F13141	31.75 x	38.10 x	3.50 x	5.80
F11678	31.75 x	38.10 x	6.35 x	4.76
F6210/1	31.75 x	39.69 x	3.97 x	7.14
F7885	31.75 x	41.27 x	4.76 x	7.93
F7885	31.75 x	41.27 x	4.76 x	7.94
F4440	31.75 x	41.27 x	5.00 x	7.94
F7506	31.75 x	41.28 x	4.76 x	6.35
_____	31.75 x	41.28 x	4.76 x	7.14
F16630	31.75 x	44.00 x	4.76 x	7.00
F4292	31.75 x	44.45 x	3.00 x	5.95
F13115	31.80 x	45.20 x	2.40 x	4.70
F8256	32.00 x	38.50 x	4.00 x	6.00
F2811	32.00 x	40.00 x	4.00 x	7.00
F11435	32.00 x	40.00 x	5.00 x	8.00
F7187	32.00 x	40.00 x	5.00 x	7.00

Código	Di x	De x	Ha1 x	Ha2
F6612/1	32.00 x	44.00 x	2.60 x	5.50
F9005/1	32.00 x	44.50 x	2.50 x	5.00
F7606	32.00 x	55.00 x	2.50 x	10.00
F3506	32.50 x	52.50 x	3.00 x	10.50
F15794	33.00 x	40.75 x	5.00 x	7.00
F543	33.00 x	45.00 x	3.00 x	6.30
F1322	33.00 x	45.50 x	5.00 x	13.00
F12882	33.34 x	42.86 x	4.76 x	7.16
F3007	33.50 x	43.50 x	8.00 x	13.00
F2095	34.00 x	42.00 x	4.50 x	7.50
F9874	34.00 x	45.50 x	4.50 x	7.00
F4121	34.00 x	51.00 x	5.00 x	7.00
F16689	34.50 x	45.00 x	6.00 x	12.00
F6991	34.92 x	44.45 x	4.70 x	7.10
F7872/2	34.92 x	44.45 x	4.76 x	7.93
F7872/2	34.92 x	44.45 x	4.76 x	7.92
F6930	34.93 x	42.86 x	2.62 x	3.57
F6991	34.93 x	44.45 x	4.76 x	7.14
F6720	35.00 x	42.50 x	2.50 x	4.00
F6119/1	35.00 x	43.00 x	2.50 x	3.50
F8621	35.00 x	43.00 x	3.00 x	4.50
F12565	35.00 x	43.00 x	3.00 x	6.00
F11683	35.00 x	43.00 x	3.00 x	6.00
F8141	35.00 x	43.00 x	5.00 x	7.00
F9086	35.00 x	43.00 x	5.00 x	7.00
F13035	35.00 x	43.80 x	5.50 x	9.50
F14434	35.00 x	44.00 x	5.00 x	9.00
F11220	35.00 x	44.30 x	5.00 x	7.00
F11220	35.00 x	44.30 x	5.20 x	7.00
F11192	35.00 x	44.45 x	2.62 x	3.57
F4233	35.00 x	45.00 x	5.00 x	7.00
F8464	35.00 x	45.00 x	5.00 x	9.00
F17028	35.00 x	45.00 x	7.00 x	10.00
F6676	35.00 x	45.20 x	5.17 x	7.50
F9581	35.00 x	47.50 x	3.20 x	8.00
F4265	35.00 x	50.00 x	5.00 x	10.00
F5218	35.00 x	50.00 x	5.00 x	10.00
F5666	35.00 x	50.00 x	5.00 x	10.50
F5514	35.00 x	55.00 x	3.00 x	8.00
F10131	35.00 x	60.00 x	6.00 x	10.00
F10231	35.98 x	39.40 x	2.80 x	4.80
F16857	36.00 x	43.70 x	4.00 x	7.50
F5805	36.00 x	44.00 x	5.00 x	7.00
F16809	36.00 x	44.50 x	4.80 x	8.00
F14852	36.00 x	45.00 x	4.00 x	7.00
F7966	36.00 x	47.00 x	7.00 x	10.00
F6655	36.00 x	50.00 x	5.00 x	7.00
F10888	36.51 x	44.45 x	2.62 x	3.57
USIN	36.60 x	44.45 x	4.76 x	8.70
USIN	37.00 x	44.00 x	5.00 x	7.50
USIN	37.00 x	48.00 x	4.50 x	9.00
F14078	38.00 x	45.00 x	2.50 x	4.00
F3720	38.00 x	45.00 x	3.50 x	4.00
F14230	38.00 x	45.00 x	7.00 x	10.00
F13786	38.00 x	52.00 x	8.00 x	45.00
F14997	38.00 x	54.50 x	5.00 x	7.00
F3719	38.00 x	69.00 x	3.00 x	10.00
F4870	38.00 x	70.00 x	3.00 x	11.00
F2854	38.10 x	46.02 x	3.17 x	4.76
F8513	38.10 x	47.62 x	4.62 x	6.50
F11176	38.10 x	47.63 x	4.76 x	7.14
F11176	38.10 x	47.63 x	4.76 x	7.14
F13227	38.10 x	50.80 x	3.00 x	6.35
F12631	38.10 x	50.80 x	7.00 x	10.00
F11829	38.10 x	60.33 x	3.18 x	12.70
F11216	38.50 x	48.20 x	4.50 x	7.50
F6047	39.00 x	48.00 x	4.00 x	7.00





Código	Di x	De x	Ha1 x	Ha2
F3511	39.00 x	48.50 x	5.00 x	8.00
F1773	39.00 x	51.50 x	3.00 x	9.00
	39.69 x	49.21 x	4.76 x	7.14
F3329	40.00 x	48.00 x	4.00 x	7.00
F10467	40.00 x	48.00 x	4.00 x	7.50
F3329	40.00 x	48.00 x	4.00 x	7.00
F7134	40.00 x	48.00 x	5.00 x	6.50
USIN	40.00 x	48.00 x	5.00 x	7.00
F5148	40.00 x	48.00 x	5.00 x	7.00
F5148	40.00 x	48.00 x	5.00 x	7.00
F9489	40.00 x	48.00 x	7.00 x	10.00
F13223	40.00 x	48.50 x	3.80 x	6.35
F11841	40.00 x	48.50 x	5.30 x	6.00
F2657	40.00 x	49.00 x	5.00 x	8.00
F15395	40.00 x	49.20 x	6.00 x	8.00
F15395	40.00 x	49.20 x	6.00 x	8.00
F14251	40.00 x	50.00 x	3.00 x	8.00
F12161	40.00 x	50.00 x	4.00 x	8.00
F7929/1	40.00 x	50.00 x	5.00 x	8.00
F14479	40.00 x	50.00 x	5.00 x	8.00
F12343	40.00 x	50.00 x	7.00 x	10.00
F14022	40.00 x	50.00 x	8.00 x	0.00
F9622	40.00 x	52.00 x	5.00 x	18.00
F5111	40.00 x	55.00 x	5.00 x	10.00
F16616	40.00 x	57.00 x	7.00 x	10.00
USIN	40.00 x	58.50 x	5.30 x	6.00
F12707	40.00 x	65.00 x	3.00 x	9.50
F3033	41.00 x	49.00 x	4.00 x	7.00
F4119	41.00 x	49.00 x	5.00 x	7.00
F5627	41.00 x	50.00 x	4.50 x	7.00
	41.28 x	50.80 x	4.76 x	7.14
F14666	41.50 x	50.00 x	6.30 x	7.60
F7197	42.00 x	50.00 x	4.00 x	7.00
F10175	42.00 x	50.00 x	5.50 x	7.00
F11852	42.00 x	50.80 x	5.00 x	7.00
F695	42.00 x	57.00 x	2.50 x	0.00
F696	42.00 x	57.00 x	14.00 x	0.00
F11019	42.00 x	64.00 x	3.50 x	10.70
F9048	42.00 x	66.50 x	3.00 x	14.00
F4457	42.50 x	52.50 x	5.00 x	6.70
F15996	42.86 x	57.15 x	5.70 x	7.20
F7052/1	43.00 x	49.00 x	1.40 x	4.30
F14265	44.00 x	49.00 x	5.00 x	7.30
F3296	44.00 x	52.00 x	4.00 x	7.00
F9446	44.00 x	54.00 x	5.00 x	6.50
F10477	44.00 x	55.00 x	5.00 x	8.00
F11797	44.00 x	56.50 x	9.00 x	12.00
F10188	44.00 x	57.00 x	14.30 x	0.00
F3495	44.40 x	52.00 x	2.70 x	4.00
F6818	44.40 x	54.00 x	5.00 x	7.50
F13701	44.45 x	52.00 x	3.50 x	4.76
F14726	44.45 x	52.38 x	5.15 x	7.93
F.....	44.45 x	52.38 x	5.15 x	7.14
F13483	44.45 x	52.39 x	3.97 x	7.14
F10113	44.45 x	53.95 x	4.75 x	7.60

Código	Di x	De x	Ha1 x	Ha2
F10113	44.45 x	53.95 x	4.75 x	7.60
F14312	44.45 x	53.95 x	5.50 x	11.00
F6134/1	44.45 x	53.97 x	4.76 x	7.00
F9964	44.45 x	53.97 x	5.40 x	6.35
USIN	44.45 x	53.97 x	6.35 x	9.53
F14684	44.45 x	63.50 x	5.00 x	7.00
F5456	44.50 x	52.00 x	1.50 x	4.00
F6551	45.00 x	52.00 x	2.50 x	4.50
F6551	45.00 x	52.00 x	2.50 x	4.50
F.....	45.00 x	52.00 x	4.50 x	8.00
F9605	45.00 x	53.00 x	4.00 x	6.00
F12566	45.00 x	53.00 x	4.00 x	7.00
F6382	45.00 x	53.00 x	5.00 x	6.50
F7189	45.00 x	53.00 x	5.00 x	8.00
F9268	45.00 x	53.50 x	5.00 x	8.00
F11147	45.00 x	53.50 x	7.00 x	3.00
F2812	45.00 x	54.00 x	5.00 x	8.00
F10340	45.00 x	55.00 x	5.00 x	7.00
F7991	45.00 x	57.00 x	6.00 x	8.00
F5665	45.00 x	60.00 x	5.50 x	10.00
F5217	45.00 x	60.00 x	6.00 x	10.00
F5217	45.00 x	60.00 x	6.00 x	10.00
F3025	45.00 x	62.00 x	3.50 x	10.00
F3014	45.00 x	62.00 x	3.50 x	10.00
F6235	45.00 x	66.00 x	3.60 x	12.70
F9099	45.00 x	70.00 x	3.00 x	12.00
F9099	45.00 x	70.00 x	3.00 x	12.00
F12854	45.40 x	56.20 x	5.30 x	0.00
F11177	46.00 x	53.00 x	2.50 x	4.00
F11580	46.00 x	60.00 x	5.00 x	9.50
F....	46.00 x	67.00 x	4.30 x	11.60
F11277	47.00 x	55.00 x	5.00 x	7.00
	47.63 x	57.15 x	4.76 x	7.14
F9014	47.90 x	52.50 x	1.60 x	3.00
F9395	48.50 x	60.50 x	5.50 x	7.60
USIN	49.00 x	62.00 x	1.00 x	3.00
F14865	49.00 x	62.00 x	4.00 x	10.00
	49.21 x	58.74 x	4.76 x	7.14
F699	49.50 x	60.20 x	5.00 x	7.50
USIN	50.00 x	56.00 x	5.00 x	7.00
F7935	50.00 x	57.00 x	5.00 x	8.00
F10232	50.00 x	58.00 x	4.00 x	5.50
F9878	50.00 x	58.00 x	4.00 x	5.50
F10230	50.00 x	58.00 x	4.00 x	8.00
F15018	50.00 x	58.00 x	5.00 x	7.00
F7192	50.00 x	58.00 x	5.00 x	8.00
F13726	50.00 x	58.00 x	6.35 x	0.00
F8296	50.00 x	58.60 x	5.30 x	7.30
F8296	50.00 x	58.60 x	5.30 x	7.30
F6220/1	50.00 x	59.00 x	6.00 x	7.00
F7406	50.00 x	59.00 x	6.00 x	9.00
F9267	50.00 x	60.00 x	2.50 x	6.00
F8914	50.00 x	60.00 x	3.00 x	5.00
F10128	50.00 x	60.00 x	3.00 x	5.00
F9333	50.00 x	60.00 x	5.00 x	7.00
F3701	50.00 x	60.00 x	5.00 x	7.00
F9333	50.00 x	60.00 x	5.00 x	7.00
F16621	50.00 x	60.00 x	5.00 x	8.00
F12879	50.00 x	61.00 x	8.50 x	6.35
F9266	50.00 x	62.00 x	5.00 x	8.00
USIN	50.00 x	62.00 x	7.00 x	10.00
F9523	50.00 x	63.45 x	6.35 x	0.00
F15135	50.00 x	90.00 x	3.20 x	14.50
F6528/1	50.50 x	58.00 x	2.50 x	0.00
F6528/1	50.50 x	58.50 x	2.50 x	4.00
F6528/1	50.50 x	58.50 x	2.50 x	4.00
F13482	50.50 x	60.00 x	6.00 x	11.00

Código	Di x	De x	Ha1 x	Ha2
F14855	50.50 x	60.00 x	6.00 x	11.00
F14855	50.50 x	60.00 x	6.00 x	11.00
F13486	50.50 x	80.00 x	6.00 x	11.00
F9407	50.80 x	58.00 x	3.00 x	4.00
F5010	50.80 x	59.50 x	2.38 x	4.76
F5010	50.80 x	59.50 x	2.38 x	4.76
F12163	50.80 x	60.00 x	6.00 x	8.80
F12163	50.80 x	60.00 x	6.35 x	9.53
USIN	50.80 x	60.30 x	4.50 x	10.00
F11566	50.80 x	60.30 x	5.00 x	7.14
F3070	50.80 x	61.70 x	3.50 x	6.35
F3643	50.80 x	61.91 x	3.97 x	7.14
F13584	50.80 x	63.50 x	6.00 x	9.50
F1071	50.80 x	63.50 x	6.00 x	8.50
F13584	50.80 x	63.50 x	6.00 x	9.50
F13584	50.80 x	63.50 x	6.00 x	9.50
F9167	50.80 x	63.80 x	5.00 x	8.00
F3050	50.80 x	65.09 x	3.57 x	0.00
F7128/2	51.00 x	58.00 x	2.50 x	4.00
F7879	51.00 x	64.00 x	3.00 x	8.00
F14946	52.00 x	62.00 x	5.40 x	8.00
F16007	52.00 x	64.00 x	6.00 x	9.50
USIN	52.30 x	65.09 x	6.35 x	9.53
F3770	52.39 x	61.91 x	4.00 x	6.35
F17063	52.50 x	59.00 x	4.50 x	9.50
F3615	53.00 x	62.00 x	2.50 x	4.50
F7291	53.97 x	66.67 x	9.52 x	6.35
F6039/1	54.00 x	60.00 x	2.00 x	6.00
F7194	54.00 x	63.50 x	5.00 x	7.00
F7194	54.00 x	63.50 x	5.00 x	7.00
F12831	54.00 x	68.00 x	6.00 x	10.00
F11400	55.00 x	63.00 x	5.00 x	6.50
F13043	55.00 x	65.00 x	5.50 x	0.00
F15045	55.00 x	67.00 x	7.00 x	7.00
F15669	55.50 x	63.70 x	5.00 x	7.80
USIN	55.56 x	63.50 x	2.62 x	3.57
F1729	55.56 x	68.26 x	3.17 x	7.94
	55.56 x	68.26 x	6.35 x	9.52
F11299	56.00 x	64.00 x	4.00 x	11.00
USIN	56.00 x	64.00 x	4.00 x	7.50
F15228	56.00 x	64.50 x	5.00 x	6.60
F8720	56.00 x	66.00 x	5.00 x	7.00
F13441	56.00 x	68.20 x	6.10 x	9.50
F13441	56.00 x	68.20 x	6.10 x	0.00
F12059	56.00 x	71.00 x	3.00 x	12.00
F8884	57.00 x	65.00 x	2.50 x	5.00
F2409	57.00 x	65.00 x	5.00 x	7.00
F15274	57.00 x	71.00 x	9.00 x	0.00
F9264	57.00 x	79.00 x	4.00 x	9.00
D-2250	57.15 x	69.85 x	6.35 x	9.52
F14856	57.15 x	73.00 x	7.00 x	10.00
F14856	57.15 x	73.00 x	7.00 x	10.00
F14856	57.15 x	73.00 x	7.00 x	10.00
F10458	57.20 x	65.20 x	4.00 x	5.00
F13873	58.00 x	47.00 x	7.00 x	0.00
F5963	58.00 x	69.00 x	6.00 x	8.00
F5606	58.20 x	68.20 x	12.00 x	18.00
	58.74 x	71.44 x	6.35 x	9.52
F6047	60.00 x	67.00 x	4.00 x	7.00
F4360	60.00 x	68.00 x	5.00 x	7.00
F7196	60.00 x	68.00 x	5.00 x	8.00
F11428	60.00 x	68.00 x	5.00 x	8.00
F14433	60.00 x	69.00 x	5.00 x	7.00
F10163	60.00 x	70.00 x	5.00 x	7.00
F4358	60.00 x	70.00 x	5.00 x	7.00
F1355	60.00 x	70.00 x	6.00 x	10.00
F1003	60.00 x	70.00 x	6.00 x	10.00

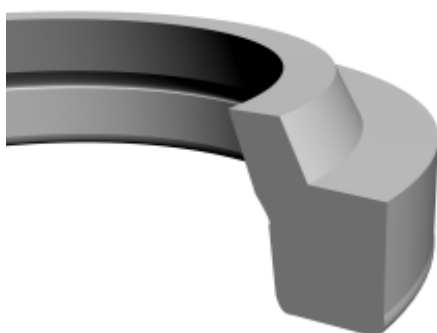



Código	Di x	De x	Ha1 x	Ha2
F1355	60.00 x	70.00 x	6.00 x	10.00
USINAD	60.00 x	70.00 x	7.00 x	10.00
F65	60.00 x	75.00 x	5.00 x	7.50
F1505	60.00 x	75.00 x	5.00 x	8.00
F9263	60.00 x	75.00 x	6.00 x	12.00
F15909	60.00 x	90.00 x	7.00 x	13.10
USIN	60.23 x	60.26 x	2.62 x	3.57
	60.33 x	73.03 x	6.35 x	9.52
F8242	61.00 x	75.00 x	9.50 x	13.50
	61.91 x	74.61 x	6.35 x	9.52
F8879	62.00 x	70.00 x	3.50 x	7.00
F6127	62.00 x	72.00 x	6.00 x	9.00
F17176	62.00 x	74.50 x	7.50 x	10.00
F3129	63.00 x	71.00 x	7.00 x	9.50
F10580	63.00 x	73.00 x	5.00 x	7.00
F11717	63.00 x	75.50 x	6.50 x	9.00
F8898	63.50 x	71.44 x	2.77 x	3.57
F14389	63.50 x	72.00 x	2.50 x	4.40
F14389	63.50 x	72.20 x	2.80 x	4.50
F1324	63.50 x	73.02 x	5.50 x	8.73
F1324	63.50 x	73.02 x	5.53 x	8.73
F8119	63.50 x	76.20 x	6.35 x	9.52
F7354	63.50 x	76.20 x	6.35 x	9.52
F3088	63.50 x	76.20 x	7.94 x	10.32
F5047	63.50 x	76.20 x	8.00 x	9.50
F9704	63.50 x	76.20 x	9.50 x	0.00
F7583	63.50 x	76.20 x	12.70 x	6.35
F14724	63.50 x	78.00 x	6.35 x	9.53
USIN	63.50 x	84.00 x	1.00 x	5.00
F8119	64.00 x	76.00 x	6.00 x	9.50
F8119	64.00 x	76.00 x	6.00 x	9.50
F4958	64.00 x	76.00 x	7.00 x	9.00
F3755	64.00 x	98.00 x	4.50 x	16.00
F12553	64.50 x	75.00 x	5.00 x	7.50
F8180	65.00 x	72.00 x	5.00 x	7.00
F4114	65.00 x	72.00 x	5.00 x	7.00
F7454	65.00 x	75.00 x	7.00 x	10.00
F11739	65.00 x	75.50 x	5.00 x	7.30
F2659	65.00 x	76.00 x	3.00 x	6.00
F3542	65.00 x	76.00 x	6.00 x	10.00
F12813	65.00 x	80.00 x	5.00 x	7.00
F14276	65.00 x	85.00 x	3.00 x	4.20
F16013	65.00 x	85.00 x	7.00 x	12.00
F6381	65.00 x	120.00 x	17.50 x	30.00
F3571	65.80 x	76.60 x	4.10 x	0.00
F8324	66.00 x	74.00 x	5.00 x	7.00
F14170	68.00 x	77.00 x	4.00 x	7.00
F12940	69.85 x	82.50 x	6.35 x	9.53
F5667	70.00 x	77.40 x	3.00 x	7.00
F8008/2	70.00 x	78.50 x	5.00 x	7.00
F8008/2	70.00 x	78.50 x	5.00 x	7.00
F8008/2	70.00 x	78.50 x	5.00 x	7.00
F12777	70.00 x	80.00 x	4.50 x	7.50
F5154	70.00 x	80.00 x	5.00 x	7.00
F9275	70.00 x	83.00 x	4.00 x	8.00

Código	Di x	De x	Ha1 x	Ha2
F7520	70.00 x	83.00 x	5.00 x	10.50
USIN	70.00 x	85.00 x	4.00 x	9.50
F5608	70.00 x	115.60 x	2.50 x	10.50
F.....	70.30 x	80.70 x	6.50 x	10.00
F15754	71.00 x	88.00 x	6.50 x	9.50
F7880	72.00 x	87.00 x	4.00 x	9.00
F8874	73.00 x	85.00 x	7.00 x	12.00
	73.03 x	85.73 x	6.35 x	9.52
F11516	74.61 x	87.31 x	6.35 x	9.50
F12106	74.61 x	87.31 x	6.35 x	9.50
F12630	75.00 x	85.00 x	5.00 x	7.00
F7473	75.00 x	87.00 x	7.00 x	12.00
F7473	75.00 x	87.00 x	7.00 x	12.00
F10839	76.00 x	85.00 x	5.00 x	0.00
USIN	76.00 x	86.00 x	3.20 x	6.40
F9940	76.20 x	86.00 x	3.00 x	5.50
F10589	76.20 x	88.40 x	6.35 x	9.50
F10589	76.20 x	88.40 x	6.35 x	9.50
F9611	76.20 x	88.90 x	7.00 x	10.00
F8237	76.20 x	88.90 x	9.00 x	11.00
F8237	76.20 x	88.90 x	9.00 x	11.00
F10641	76.20 x	90.00 x	6.35 x	9.50
F8545	76.50 x	90.00 x	3.00 x	8.50
F14171	77.00 x	140.00 x	6.00 x	11.00
F9274	78.00 x	86.00 x	5.00 x	7.00
F8848	78.00 x	90.00 x	7.00 x	12.00
USIN	79.00 x	95.50 x	6.00 x	9.00
	79.38 x	92.08 x	6.35 x	9.52
F11954	80.00 x	87.50 x	5.00 x	7.50
F13484	80.00 x	88.00 x	4.00 x	0.00
F9272	80.00 x	90.00 x	6.00 x	7.00
F14348	80.00 x	90.00 x	8.00 x	12.00
F4354	80.00 x	92.00 x	5.00 x	7.00
F8639	80.00 x	92.00 x	7.00 x	12.00
F8272	80.00 x	92.00 x	7.00 x	12.00
F8272	80.00 x	92.00 x	7.00 x	12.00
F7385	80.00 x	120.00 x	3.00 x	15.00
F3351	80.96 x	88.90 x	6.35 x	9.52
F10944	81.00 x	88.00 x	10.00 x	5.00
F15439	82.00 x	101.60 x	8.00 x	12.00
F4156	82.50 x	89.50 x	4.00 x	7.00
F11114	82.50 x	92.08 x	3.07 x	4.37
F14695	82.50 x	127.00 x	4.30 x	12.70
	82.55 x	95.25 x	6.35 x	9.52
F11393	83.50 x	97.50 x	7.00 x	13.00
F8694	85.00 x	95.00 x	5.00 x	7.00
F8694	85.00 x	95.00 x	5.00 x	7.00
F14435	85.00 x	97.50 x	7.00 x	12.00
F14045	85.50 x	92.00 x	5.50 x	0.00
F11219	85.50 x	98.40 x	6.50 x	9.30
F8987	86.00 x	78.00 x	4.00 x	6.00
F12459	87.00 x	94.00 x	5.00 x	7.00
F10691	88.60 x	102.00 x	6.30 x	1.70
F7359	88.90 x	98.43 x	5.00 x	7.94
USIN	88.90 x	99.05 x	6.00 x	11.00
	88.90 x	101.60 x	6.35 x	0.00
F12950	88.90 x	152.40 x	14.30 x	3.20
F10780	89.00 x	101.50 x	7.00 x	9.00
F12205	89.00 x	102.00 x	9.55 x	3.50
F10738	90.00 x	100.00 x	4.50 x	7.00
F3165	90.00 x	100.00 x	7.00 x	10.00
F3654	90.00 x	102.00 x	6.30 x	9.30
F7199	90.00 x	102.00 x	6.50 x	12.00
F7199	90.00 x	102.00 x	6.50 x	12.00
F4177	90.00 x	102.20 x	7.10 x	10.00
F3574	91.50 x	102.50 x	7.20 x	12.00
USIN	92.00 x	105.00 x	6.00 x	9.00

Código	Di x	De x	Ha1 x	Ha2
F6206	92.47 x	106.36 x	6.35 x	12.70
F4168	92.50 x	104.50 x	6.50 x	12.50
F3143	93.00 x	102.00 x	5.00 x	6.50
F32	93.66 x	101.60 x	3.17 x	6.35
F15327	94.00 x	104.00 x	3.10 x	5.50
F14454	94.00 x	106.00 x	7.00 x	12.00
F6925	95.00 x	102.00 x	3.00 x	4.60
	95.25 x	108.00 x	6.35 x	9.52
F11218	95.50 x	105.00 x	3.20 x	7.00
F15522	96.00 x	110.00 x	7.00 x	0.00
USIN	97.00 x	108.00 x	6.35 x	9.53
USIN	97.00 x	110.00 x	3.80 x	6.35
F10451	98.00 x	116.00 x	5.00 x	12.00
F1364	98.40 x	109.50 x	5.50 x	10.00
F9270	98.50 x	108.50 x	5.00 x	7.50
F7560	99.50 x	107.50 x	3.50 x	7.20
USIN	99.80 x	116.00 x	5.00 x	9.00
F3078	100.00 x	107.60 x	3.50 x	7.50
F3974	100.00 x	109.00 x	4.00 x	8.50
F10623	100.00 x	110.00 x	7.00 x	10.00
F2062	100.00 x	111.00 x	6.50 x	12.00
F7198	100.00 x	112.00 x	6.50 x	12.00
F10213	100.00 x	112.00 x	7.00 x	13.00
USIN	100.00 x	116.00 x	6.35 x	9.53
F3751	100.00 x	130.00 x	3.00 x	13.00
F4466	101.60 x	111.60 x	5.00 x	7.00
F10056	101.60 x	112.71 x	3.47 x	5.16
USIN	101.60 x	114.30 x	6.35 x	10.00
F9713	105.00 x	117.00 x	7.15 x	8.75
F8646	107.00 x	122.00 x	6.00 x	8.00
F9269	107.95 x	119.06 x	3.45 x	6.20
F4773	108.00 x	120.00 x	6.00 x	10.00
	108.00 x	120.70 x	6.35 x	9.52
F3319	108.00 x	154.00 x	3.50 x	0.00
F14693	108.00 x	154.00 x	3.50 x	16.00
F8646	108.80 x	122.00 x	6.50 x	9.80
F17220	110.00 x	122.00 x	5.50 x	10.00
F9319	110.00 x	122.00 x	7.00 x	12.00
F2398	110.00 x	132.00 x	3.00 x	12.50
	111.10 x	123.80 x	6.35 x	9.52
F14200	112.00 x	165.10 x	5.55 x	22.22
F13485	114.30 x	125.40 x	3.90 x	0.00
USIN	114.30 x	127.00 x	6.35 x	9.53
F4755	114.30 x	127.00 x	7.94 x	11.90
USIN	114.30 x	133.40 x	9.52 x	14.28
F8038	115.00 x	125.00 x	6.00 x	10.00
F8756	115.00 x	127.00 x	7.00 x	12.00
F4459	115.00 x	133.00 x	12.00 x	17.00
F4460	117.00 x	129.00 x	6.00 x	10.00
F12357	117.48 x	136.53 x	9.53 x	14.29
F14341	117.70 x	127.00 x	9.00 x	12.00
F14109	117.80 x	190.50 x	3.96 x	5.75
F13335	118.00 x	130.50 x	4.80 x	7.00
F4068	119.00 x	133.00 x	6.50 x	12.00
F14173	120.00 x	127.00 x	4.00 x	7.00
F13433	120.00 x	127.50 x	5.10 x	0.00
F6260	120.00 x	130.00 x	6.00 x	12.00
F7812	120.00 x	130.00 x	7.15 x	10.00
F14540	120.00 x	132.00 x	3.60 x	5.60
F14540	120.00 x	132.00 x	3.60 x	5.60
F9655	120.00 x	135.00 x	7.00 x	12.00
	120.70 x	139.70 x	9.52 x	14.28
F11217	121.00 x	131.50 x	3.30 x	5.80
F14208	123.83 x	142.83 x	9.53 x	14.29
F9168	125.00 x	134.00 x	6.00 x	10.00
F11942	125.00 x	137.00 x	5.00 x	10.00
F12415	125.00 x	137.00 x	7.00 x	10.00







Código	Di x	De x	Ha1 x	Ha2
F13145	125.00	x138.00	x 5.50	x 0.00
F10779	125.00	x138.00	x 7.00	x 10.00
F7375	126.00	x135.00	x 5.00	x 7.00
F921	127.00	x140.00	x 7.00	x 9.00
_____	127.00	x146.10	x 9.52	x 14.28
_____	129.40	x149.20	x 9.52	x 14.28
F10021	130.00	x138.00	x 5.00	x 7.00
F10021	130.00	x138.00	x 5.00	x 7.00
F6128	130.00	x142.00	x 7.00	x 12.00
_____	133.40	x152.40	x 9.52	x 14.28
F1782	134.94	x158.75	x 6.35	x 12.70
F16823	137.60	x148.60	x 6.30	x 10.00
F9442	139.00	x170.00	x 6.50	x 23.00
F13224	139.70	x153.00	x 7.14	x 0.00
F14044	139.70	x158.80	x 9.50	x 12.00
F14044	139.70	x158.80	x 12.00	x 0.00
F15524	140.00	x151.50	x 6.70	x 11.80
F8873	140.00	x153.00	x 7.00	x 12.00
F9155	140.00	x155.00	x 10.00	x 16.00
F3752	140.00	x159.00	x 9.50	x 15.00
F11061	140.00	x162.00	x 6.00	x 12.00
F6384	140.00	x200.00	x 17.50	x 30.00
F14934	140.50	x191.50	x 5.00	x 14.50
F7143	141.29	x174.62	x 4.76	x 15.80
F11499	145.00	x157.20	x 7.10	x 10.50
F7888	145.00	x165.00	x 6.00	x 12.00
F14555	146.05	x171.45	x 4.37	x 12.70
_____	146.10	x165.10	x 9.52	x 14.28
USIN	149.22	x168.27	x 9.50	x 14.40
F11445	150.00	x160.00	x 10.00	x 16.00
F10913	150.00	x162.00	x 7.00	x 10.00
F6213	150.00	x162.00	x 7.50	x 12.00
F4359	150.00	x162.00	x 7.50	x 12.00
F10856	150.00	x163.00	x 16.00	x 9.50
F7813	150.00	x165.00	x 9.20	x 12.00
F11445	150.00	x165.00	x 10.00	x 16.00
F8988	150.00	x167.00	x 9.00	x 14.00
USIN	152.40	x165.10	x 6.50	x 12.50
_____	152.40	x171.50	x 9.52	x 14.28

Código	Di x	De x	Ha1 x	Ha2
F7376	154.00	x163.00	x 5.00	x 7.00
F5155	155.00	x170.00	x 7.50	x 10.00
_____	158.80	x177.80	x 9.52	x 14.28
_____	158.80	x184.20	x 9.52	x 14.28
F14789	160.00	x171.00	x 7.50	x 11.50
F10100	160.00	x175.00	x 7.00	x 12.00
F12434	160.00	x175.00	x 7.00	x 12.00
F10100	160.00	x175.00	x 7.00	x 12.00
USIN	160.00	x175.00	x 9.50	x 14.00
F17085	160.00	x200.00	x 15.00	x 20.00
B.GROB	160.00	x200.00	x 15.00	x 20.00
F12839	165.00	x203.00	x 5.50	x 17.20
USIN	167.50	x197.00	x 7.00	x 16.00
F11821	170.00	x182.00	x 5.00	x 7.00
F3712	170.00	x182.00	x 7.00	x 12.00
F5489	170.00	x198.50	x 3.80	x 15.00
_____	171.50	x190.35	x 9.52	x 14.28
F14420	172.00	x205.00	x 3.00	x 15.00
USIN	175.00	x200.00	x 9.50	x 14.20
F17234	175.00	x275.00	x 25.40	x 0.00
F13488	176.60	x187.30	x 7.50	x 0.00
F7867	177.80	x196.80	x 14.20	x 9.50
F11664	180.00	x194.00	x 8.00	x 10.00
F11153	180.00	x195.00	x 5.00	x 7.00
F6492	180.00	x200.00	x 10.00	x 18.00
USIN	185.00	x200.00	x 6.35	x 10.00
F9184	187.00	x201.00	x 2.00	x 6.00
F8878	190.00	x196.00	x 5.00	x 7.00
F14437	190.00	x198.00	x 5.00	x 7.00
F.COUR	193.50	x232.80	x 3.00	x 10.00
_____	196.90	x215.90	x 9.52	x 14.28
F5779	200.00	x212.00	x 5.00	x 7.00
F2161	201.00	x215.00	x 6.00	x 13.00
_____	203.20	x222.30	x 9.52	x 14.28
USIN	209.00	x227.50	x 9.50	x 15.40
USIN	209.50	x227.50	x 9.50	x 14.50
F11436	209.55	x240.90	x 9.00	x 14.28
_____	209.60	x228.60	x 9.52	x 14.28
F15808	211.00	x224.00	x 6.60	x 11.80

Código	Di x	De x	Ha1 x	Ha2
F11500	213.00	x257.00	x 10.00	x 16.00
F5659	215.00	x223.00	x 4.50	x 9.50
USIN	215.00	x228.30	x 10.00	x 16.00
F12677	215.90	x234.96	x 9.52	x 12.70
F8872	220.00	x228.00	x 5.00	x 7.00
USINAD	220.00	x238.00	x 10.00	x 18.00
F10911	220.00	x240.00	x 10.00	x 15.00
F4097	220.00	x240.00	x 10.00	x 18.00
F12828	228.00	x305.00	x 27.00	x 5.00
_____	228.60	x247.70	x 9.52	x 14.28
F7329	230.00	x244.00	x 7.00	x 12.00
USIN	230.00	x250.00	x 12.00	x 18.00
_____	235.00	x254.00	x 9.52	x 14.28
F6904	240.00	x260.00	x 14.00	x 20.00
F4951	247.65	x269.80	x 11.10	x 19.05
F16905	247.65	x273.05	x 9.70	x 14.00
F9011	250.00	x270.00	x 10.00	x 18.00
F10511	254.00	x279.10	x 12.70	x 19.50
_____	260.40	x285.80	x 12.70	x 19.05
F7567	266.70	x292.10	x 19.05	x 9.80
F6710	280.00	x300.00	x 10.00	x 17.00
F14468	280.00	x305.00	x 10.00	x 18.00
F10085	300.00	x330.00	x 15.00	x 23.00
F14004	305.00	x330.00	x 10.00	x 0.00
F14003	305.00	x330.00	x 12.50	x 19.00
F14003	305.00	x330.00	x 19.00	x 0.00
F11015	308.00	x406.00	x 8.00	x 19.00
F4766	323.85	x400.05	x 19.05	x 38.00
F15484	350.00	x385.00	x 9.50	x 19.00
USIN	355.00	x365.00	x 10.00	x 16.00
F8784	394.00	x415.00	x 10.00	x 15.00
F9153	458.00	x488.00	x 14.50	x 23.50
F8820	530.00	x500.00	x 15.00	x 20.00
F15479	530.00	x551.00	x 10.00	x 18.00
F7691	610.00	x642.00	x 11.00	x 22.00
F8509	630.00	x730.00	x 50.00	x 80.00
F15491	642.00	x660.00	x 9.60	x 18.00
F15532	650.00	x670.00	x 10.00	x 18.00





# Raspadores



INCOVE VEDAÇÕES LTDA.

Cód.	Di x	De x	Ha1 x	Ha2
12773	6.00 x	13.00 x	2.50 x	5.00
11233	8.00 x	14.00 x	3.50 x	5.00
12679	9.00 x	14.00 x	3.20 x	4.50
—	9.00 x	16.00 x	9.00 x	15.00
11386	9.53 x	14.29 x	3.17 x	4.37
13646	9.53 x	14.29 x	3.96 x	—
15545	9.53 x	25.40 x	7.94 x	—
11127	10.00 x	16.00 x	3.50 x	5.00
22580	10.00 x	18.00 x	5.00 x	7.00
12720	10.00 x	19.00 x	3.00 x	5.00
12337	10.00 x	19.60 x	2.30 x	7.50
11518	10.00 x	20.00 x	5.00 x	10.00
12525	10.00 x	20.00 x	5.00 x	8.00
—	11.00 x	16.00 x	6.00 x	8.50
20379	11.50 x	22.00 x	4.00 x	5.00
16371	12.00 x	16.00 x	3.00 x	4.00
12939	12.00 x	18.00 x	3.50 x	5.00
13641	12.00 x	20.00 x	4.00 x	6.00
11531	12.00 x	20.00 x	4.00 x	10.00
22471	12.00 x	20.00 x	4.00 x	6.00
11592	12.00 x	20.00 x	5.00 x	8.00
16368	12.00 x	22.00 x	3.50 x	4.50
11283	12.00 x	22.00 x	5.00 x	8.50
16278	12.70 x	18.00 x	3.00 x	4.50
13725	12.70 x	28.58 x	7.14 x	9.52
12836	13.00 x	22.00 x	5.00 x	8.00
16490	13.00 x	24.00 x	5.00 x	7.00
12173	14.00 x	20.00 x	3.00 x	5.00
12814	14.00 x	22.00 x	3.00 x	4.00
12940	14.40 x	21.00 x	4.00 x	5.50
12902	15.00 x	21.00 x	3.50 x	5.00
16787	15.00 x	25.00 x	3.00 x	4.00
12568	15.00 x	25.00 x	5.00 x	8.00
11591	15.00 x	25.00 x	7.00 x	10.00
16755	15.00 x	25.15 x	3.00 x	4.00
15057	15.00 x	25.40 x	3.30 x	4.60
20307	15.00 x	25.40 x	5.50 x	8.00
20110	15.00 x	26.00 x	1.80 x	3.70
20081	15.50 x	26.00 x	5.00 x	7.00
20404	15.87 x	28.70 x	2.90 x	2.50
11151	16.00 x	22.00 x	3.00 x	5.00
22531	16.00 x	22.00 x	3.00 x	4.00
16651	16.00 x	22.00 x	3.20 x	4.00
20210	16.00 x	24.00 x	5.00 x	7.00
11810	16.00 x	24.00 x	6.00 x	7.00
20210	16.00 x	24.00 x	7.00 x	—
11774	16.00 x	26.00 x	3.00 x	5.00
12563	16.00 x	26.00 x	5.00 x	8.00
11888	16.00 x	26.00 x	7.00 x	10.00
16379	18.00 x	22.00 x	3.50 x	4.50
12923	18.00 x	25.00 x	5.00 x	7.00
22579	18.00 x	26.00 x	5.00 x	7.00
25427	18.00 x	26.00 x	6.00 x	9.00
11065	18.00 x	28.00 x	7.00 x	10.00
22421	18.00 x	30.00 x	6.00 x	8.00

Cód.	Di x	De x	Ha1 x	Ha2
16808	18.80 x	26.00 x	4.00 x	5.00
11356	19.00 x	26.00 x	5.00 x	8.00
16277	19.00 x	30.00 x	5.00 x	8.00
16420	19.00 x	30.00 x	7.00 x	10.00
16630	20.00 x	26.00 x	4.00 x	7.00
13727	20.00 x	28.00 x	3.00 x	4.90
12605	20.00 x	28.00 x	3.50 x	5.00
16202	20.00 x	28.00 x	4.00 x	7.00
12796	20.00 x	28.00 x	7.00 x	10.00
11517	20.00 x	30.00 x	4.00 x	6.00
12934	20.00 x	30.00 x	5.00 x	7.00
12905	20.00 x	30.00 x	7.00 x	10.00
12468	20.00 x	31.50 x	7.00 x	9.00
16988	20.00 x	32.00 x	5.00 x	7.00
11306	20.00 x	35.00 x	7.00 x	10.00
18931	20.64 x	27.78 x	4.76 x	—
16482	21.00 x	28.00 x	3.50 x	5.50
11920	21.00 x	35.00 x	7.00 x	10.00
11920	21.00 x	35.00 x	7.00 x	10.00
12489	22.00 x	28.00 x	2.50 x	4.00
11468	22.00 x	28.00 x	5.00 x	9.00
20124	22.00 x	30.00 x	5.00 x	7.00
11634	22.00 x	30.00 x	5.00 x	10.00
11395	22.00 x	30.00 x	7.00 x	10.00
12936	22.00 x	32.00 x	5.00 x	7.00
12561	22.00 x	32.00 x	7.00 x	10.00
11921	22.00 x	35.00 x	5.00 x	8.00
11921	22.00 x	35.00 x	5.00 x	8.00
16269	22.00 x	35.00 x	8.00 x	10.00
11280	22.22 x	28.57 x	3.17 x	3.97
16159	24.00 x	34.00 x	5.00 x	7.00
12189	24.00 x	35.00 x	4.00 x	6.00
20197	24.00 x	35.00 x	7.00 x	12.00
16367	25.00 x	31.00 x	3.00 x	4.00
11911	25.00 x	32.00 x	5.00 x	7.50
16042	25.00 x	34.00 x	4.50 x	6.50
16780	25.00 x	35.00 x	4.00 x	7.00
13909	25.00 x	35.00 x	5.00 x	7.50
12543	25.00 x	35.00 x	5.00 x	7.00
12543	25.00 x	35.00 x	5.00 x	7.00
12543	25.00 x	35.00 x	5.00 x	7.00
13992	25.00 x	35.00 x	7.00 x	10.00
22541	25.00 x	35.00 x	7.00 x	10.00
11570	25.00 x	37.00 x	7.00 x	9.00
20229	25.40 x	35.50 x	3.50 x	6.00
20229	25.40 x	35.50 x	3.50 x	6.00
20398	25.40 x	40.08 x	4.70 x	7.00
11467	26.00 x	32.00 x	5.00 x	8.00
11540	26.00 x	34.00 x	5.00 x	8.00
12034	27.00 x	32.50 x	5.00 x	8.00
11719	28.00 x	34.00 x	5.00 x	—
11719	28.00 x	34.00 x	5.00 x	7.00
11719	28.00 x	34.00 x	7.00 x	—
12933	28.00 x	38.00 x	5.00 x	7.00
12858	28.00 x	38.00 x	7.00 x	10.00
16631	28.00 x	40.00 x	5.00 x	7.00
12497	28.00 x	40.00 x	7.00 x	10.00
12935	28.54 x	36.00 x	4.30 x	6.00
11902	30.00 x	37.00 x	4.00 x	5.00
16492	30.00 x	38.00 x	7.00 x	10.00
12941	30.00 x	40.00 x	5.00 x	7.00
16298	30.00 x	40.00 x	5.00 x	8.00
13540	30.00 x	40.00 x	6.00 x	8.00
12090	30.00 x	40.00 x	7.00 x	10.00
20161	30.00 x	40.00 x	7.00 x	11.00
20161	30.00 x	40.00 x	7.00 x	11.00
16298	30.00 x	40.00 x	7.00 x	—

Cód.	Di x	De x	Ha1 x	Ha2
20161	30.00 x	40.00 x	7.00 x	11.00
16560	30.00 x	42.00 x	6.00 x	9.00
20136	30.00 x	42.00 x	9.00 x	12.00
16719	30.00 x	45.00 x	5.00 x	8.00
12929	30.00 x	45.00 x	7.00 x	10.00
12571	30.00 x	50.00 x	7.00 x	10.00
22565	30.00 x	58.00 x	4.00 x	7.00
12995	31.75 x	38.10 x	3.17 x	4.76
11806	32.00 x	42.00 x	5.00 x	7.00
11159	32.00 x	45.00 x	4.50 x	9.00
11350	32.00 x	45.00 x	7.00 x	10.00
25367	32.50 x	42.00 x	7.00 x	8.80
12484	32.50 x	45.00 x	4.00 x	8.00
16704	33.00 x	50.60 x	9.00 x	16.50
11080	34.00 x	42.00 x	4.00 x	7.00
11597	34.00 x	45.00 x	7.00 x	10.00
12750	35.00 x	40.00 x	7.00 x	10.00
11790	35.00 x	43.00 x	3.00 x	4.50
16160	35.00 x	43.00 x	5.00 x	7.00
16211	35.00 x	43.00 x	6.00 x	9.00
13993	35.00 x	45.00 x	7.00 x	10.00
22458	35.00 x	47.00 x	7.00 x	10.00
11305	35.00 x	52.00 x	7.00 x	10.00
12816	36.00 x	45.00 x	7.00 x	10.00
12938	36.00 x	46.00 x	5.00 x	7.00
13912	37.00 x	45.00 x	7.00 x	10.00
12469	38.00 x	48.00 x	7.00 x	10.00
11665	38.00 x	50.00 x	7.00 x	10.00
20403	38.10 x	60.40 x	7.50 x	9.50
20377	40.00 x	47.00 x	2.00 x	4.00
12544	40.00 x	50.00 x	5.00 x	7.00
12897	40.00 x	50.00 x	5.00 x	8.00
12009	40.00 x	50.00 x	7.00 x	10.00
16914	40.00 x	52.00 x	6.00 x	8.00
11970	40.00 x	52.00 x	7.00 x	10.00
11970	40.00 x	52.00 x	7.00 x	10.00
12467	40.00 x	53.50 x	8.00 x	10.00
20061	40.00 x	55.00 x	5.00 x	8.00
11734	40.00 x	56.00 x	7.00 x	10.00
25423	40.00 x	57.00 x	7.00 x	10.00
11039	40.00 x	62.00 x	5.00 x	10.00
11602	40.50 x	52.00 x	8.00 x	11.00
12542	42.00 x	52.00 x	7.00 x	10.00
13556	42.86 x	63.50 x	3.97 x	6.35
20228	43.00 x	52.00 x	7.00 x	—
20228	43.00 x	52.00 x	7.00 x	10.00
16287	44.00 x	62.00 x	5.00 x	10.00
20338	44.50 x	57.00 x	5.00 x	8.00
20264	45.00 x	53.50 x	5.00 x	8.00
12942	45.00 x	55.00 x	5.00 x	7.00
12089	45.00 x	55.00 x	7.00 x	10.00
16319	45.00 x	55.00 x	7.00 x	10.00
25445	45.00 x	57.00 x	7.00 x	10.00
12107	45.00 x	60.00 x	7.00 x	10.00
11922	45.00 x	75.00 x	7.00 x	10.00
16095	45.50 x	55.70 x	5.00 x	8.00
20347	47.00 x	55.00 x	5.00 x	8.00
11551	47.00 x	57.00 x	7.00 x	10.00
20247	47.00 x	58.00 x	7.00 x	10.00
20247	47.00 x	58.00 x	7.00 x	10.00
16563	48.00 x	60.00 x	7.00 x	10.00
12581	50.00 x	56.00 x	5.00 x	7.00
12696	50.00 x	56.00 x	7.00 x	10.00
16806	50.00 x	58.00 x	4.00 x	7.00
12901	50.00 x	60.00 x	5.00 x	7.00
22522	50.00 x	60.00 x	5.00 x	10.00
12088	50.00 x	60.00 x	7.00 x	10.00





# Raspadores



INCOVE VEDAÇÕES LTDA.

Cód.	Di x	De x	Ha1 x	Ha2
20333	50.00 x	62.00 x	5.00 x	7.00
20333	50.00 x	62.00 x	5.00 x	7.00
20333	50.00 x	62.00 x	5.00 x	7.00
20333	50.00 x	62.00 x	5.00 x	7.00
11075	50.00 x	62.00 x	7.00 x	10.00
20155	50.00 x	65.00 x	8.00 x	12.00
11463	50.00 x	66.00 x	5.00 x	7.00
16534	50.00 x	70.00 x	7.00 x	10.00
16463	50.30 x	64.50 x	8.00 x	10.00
20348	50.80 x	62.00 x	5.00 x	8.00
16494	50.80 x	63.70 x	8.00 x	12.00
25366	52.00 x	62.00 x	7.00 x	10.00
16003	54.00 x	62.00 x	4.00 x	4.50
13886	55.00 x	63.00 x	7.00 x	10.00
20349	55.00 x	63.50 x	5.00 x	8.00
16659	55.00 x	65.00 x	5.00 x	7.00
12066	55.00 x	65.00 x	7.00 x	10.00
16849	56.00 x	60.00 x	7.00 x	10.00
16915	56.00 x	65.00 x	7.00 x	10.00
20162	56.00 x	66.00 x	5.00 x	7.00
11613	56.00 x	66.00 x	7.00 x	10.00
16172	56.90 x	76.30 x	2.50 x	4.30
20287	57.00 x	74.00 x	7.00 x	10.00
12104	58.74 x	69.85 x	7.14 x	11.91
16887	59.80 x	76.50 x	14.00 x	16.00
12898	60.00 x	70.00 x	5.00 x	7.00
20350	60.00 x	70.00 x	5.00 x	8.00
12552	60.00 x	70.00 x	7.00 x	10.00
16307	60.00 x	74.00 x	5.00 x	8.00
12671	60.00 x	74.00 x	5.00 x	8.00
11599	60.00 x	74.00 x	8.00 x	11.00
20406	60.00 x	74.00 x	8.00 x	11.00
13998	60.00 x	74.00 x	10.00 x	15.00
16957	60.00 x	75.00 x	7.00 x	8.00
16394	60.00 x	80.00 x	7.00 x	10.00
16394	60.00 x	80.00 x	7.00 x	10.00
20145	60.00 x	85.00 x	7.00 x	10.00
20145	60.00 x	85.00 x	7.00 x	10.00
15238	60.00 x	140.00 x	6.00 x	12.00
12832	62.00 x	72.00 x	7.00 x	10.00
20298	63.00 x	73.00 x	5.00 x	7.00
16464	63.00 x	75.00 x	7.00 x	10.00
11429	63.00 x	75.00 x	7.00 x	10.00
16886	63.00 x	75.50 x	6.50 x	9.00
20367	63.00 x	85.00 x	5.00 x	8.00
20275	63.50 x	76.20 x	5.95 x	9.50
20356	63.50 x	82.55 x	9.52 x	12.70

Cód.	Di x	De x	Ha1 x	Ha2
11218	65.00 x	70.00 x	7.00 x	10.00
12992	65.00 x	75.00 x	5.00 x	7.00
20351	65.00 x	75.00 x	5.00 x	8.00
12060	65.00 x	75.00 x	7.00 x	10.00
20133	65.00 x	85.00 x	5.00 x	8.00
11673	65.00 x	85.00 x	7.00 x	10.00
11962	69.00 x	75.00 x	5.00 x	8.00
20352	69.00 x	77.00 x	5.00 x	8.00
16813	70.00 x	78.00 x	4.00 x	7.00
16767	70.00 x	80.00 x	5.00 x	7.00
13740	70.00 x	80.00 x	7.00 x	10.00
16483	70.00 x	80.00 x	7.00 x	10.00
22566	70.00 x	85.00 x	7.00 x	10.00
16509	73.00 x	83.00 x	7.00 x	10.00
16905	73.50 x	85.00 x	4.00 x	8.00
25379	74.00 x	85.25 x	7.00 x	1.00
17983	74.61 x	96.04 x	12.70 x	—
12527	75.00 x	85.00 x	7.00 x	10.00
16902	75.00 x	89.00 x	8.00 x	11.00
12737	75.00 x	95.00 x	10.00 x	15.00
20405	76.00 x	90.00 x	4.80 x	6.50
16329	76.20 x	88.90 x	4.76 x	6.35
22588	78.00 x	90.00 x	7.00 x	10.00
11903	78.00 x	90.00 x	7.00 x	10.00
16178	80.00 x	88.00 x	4.00 x	7.00
16292	80.00 x	88.00 x	7.00 x	10.00
12802	80.00 x	90.00 x	7.00 x	10.00
12802	80.00 x	90.00 x	7.00 x	10.00
11768	80.00 x	94.00 x	8.00 x	11.00
11183	80.00 x	95.00 x	7.00 x	10.00
20293	80.00 x	100.00 x	13.00 x	15.50
20293	80.00 x	100.00 x	16.00 x	—
16731	82.00 x	92.00 x	7.00 x	10.00
11898	85.00 x	90.00 x	7.00 x	10.00
11018	85.00 x	95.00 x	7.00 x	10.00
20051	85.00 x	95.00 x	7.00 x	10.00
11251	85.00 x	97.00 x	7.00 x	12.00
16029	85.00 x	101.00 x	8.00 x	10.00
11909	90.00 x	98.00 x	4.00 x	7.00
12087	90.00 x	100.00 x	7.00 x	10.00
11996	90.00 x	102.00 x	7.00 x	12.00
20386	90.00 x	105.00 x	7.00 x	10.00
11072	92.00 x	107.00 x	7.00 x	13.00
11073	95.00 x	105.00 x	7.00 x	10.00
22433	95.00 x	115.00 x	7.00 x	9.50
16257	95.00 x	115.00 x	10.00 x	13.00
16766	100.00 x	110.00 x	5.00 x	7.00

Cód.	Di x	De x	Ha1 x	Ha2
12703	100.00 x	110.00 x	7.00 x	10.00
11430	100.00 x	110.00 x	11.00 x	13.00
11083	100.00 x	112.00 x	7.00 x	12.00
16551	100.00 x	115.00 x	7.00 x	10.00
22501	100.00 x	115.00 x	7.00 x	10.00
16632	100.00 x	122.00 x	7.00 x	10.00
20230	101.00 x	114.00 x	12.00 x	—
11161	102.00 x	110.00 x	7.00 x	9.00
25369	105.00 x	115.00 x	7.00 x	10.00
12021	110.00 x	120.00 x	7.00 x	10.50
12021	110.00 x	120.00 x	7.00 x	10.50
11974	115.00 x	125.00 x	5.00 x	7.00
11009	120.00 x	130.00 x	7.00 x	10.00
12684	120.00 x	135.00 x	10.00 x	12.00
16524	120.00 x	136.00 x	9.00 x	12.00
11162	125.00 x	137.00 x	7.00 x	12.00
11997	125.00 x	140.00 x	9.00 x	12.00
12756	125.00 x	140.00 x	9.00 x	12.00
22540	125.00 x	140.00 x	10.00 x	16.00
20209	130.00 x	145.00 x	12.00 x	—
11885	135.00 x	145.00 x	7.00 x	10.00
12980	135.00 x	150.00 x	9.00 x	12.00
12863	135.00 x	155.00 x	10.00 x	16.00
20318	135.00 x	205.00 x	11.12 x	18.50
11797	140.00 x	150.00 x	7.00 x	10.00
16844	140.00 x	155.00 x	9.00 x	12.00
16917	140.00 x	155.00 x	9.00 x	12.00
11052	140.00 x	155.00 x	10.00 x	16.00
20248	148.00 x	160.00 x	7.00 x	10.00
20248	148.00 x	160.00 x	10.00 x	—
11890	150.00 x	125.00 x	7.00 x	10.00
11421	150.00 x	165.00 x	9.00 x	12.00
16167	150.00 x	167.00 x	9.00 x	14.00
16577	150.00 x	170.00 x	8.00 x	11.00
12996	160.00 x	175.00 x	9.00 x	12.00
11588	170.00 x	185.00 x	10.00 x	14.00
11031	180.00 x	200.00 x	10.00 x	18.00
16002	188.00 x	200.00 x	7.00 x	10.00
20330	190.00 x	202.00 x	9.00 x	12.00
11003	199.00 x	220.00 x	12.00 x	16.00
16765	210.00 x	230.00 x	12.00 x	16.00
16201	240.00 x	260.00 x	12.00 x	16.00
11554	250.00 x	270.00 x	10.00 x	18.00
11326	260.00 x	290.00 x	12.00 x	17.00
11764	288.00 x	330.00 x	6.00 x	11.00
12555	339.80 x	370.00 x	16.00 x	22.00
16859	400.00 x	420.00 x	12.00 x	—



## Anel Externo TAE

Externo  
Anel  
PTFE

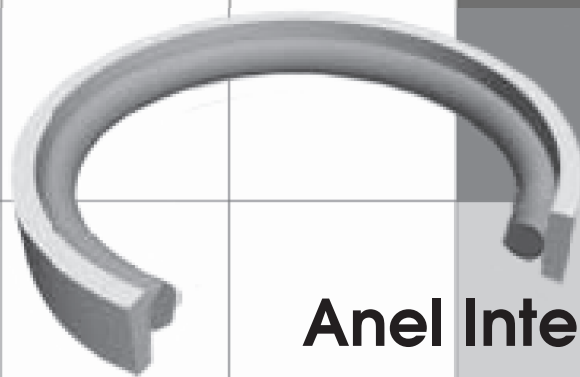

## Anel Interno TAI

Interno  
Anel  
PTFE

**INCOVE**<sup>®</sup>

INCOVE VEDAÇÕES LTDA.

**IG**

*Geométrico\**

*Incove*

\* Soluções de problemas geométricos pelo cálculo

Código	Mod.	Mat.	Di x	De x	Ha1
200780	UESP	NITR	6.00 x	8.90 x	2.40
200165	TAE	TAAN	6.00 x	10.80 x	3.70
200084	TAI	TAAN	7.10 x	12.00 x	2.20
200001	TAI	TAAN	7.10 x	12.00 x	2.20
200003	TAI	TAAN	7.50 x	15.00 x	7.50
200290	TAE	TAAN	7.90 x	3.00 x	2.20
200166	TAE	TAAN	8.00 x	12.80 x	3.70
200695	TAE	TAAN	8.00 x	12.90 x	2.20
200696	TAE	TAAN	8.00 x	15.30 x	3.20
200005	TAI	TAAN	8.50 x	16.00 x	3.20
200291	TAE	TAAN	8.90 x	4.00 x	2.20
200085	TAI	TAAN	9.10 x	14.00 x	2.20
200002	TAI	TAAN	9.10 x	14.00 x	2.20
200292	TAE	TAAN	9.90 x	5.00 x	2.20
200167	TAE	TAAN	10.00 x	14.80 x	—
200697	TAE	TAAN	10.00 x	14.90 x	2.20
200698	TAE	TAAN	10.00 x	17.30 x	3.20
200086	TAI	TAAN	10.10 x	15.00 x	2.20
200006	TAI	TAAN	10.50 x	18.00 x	3.20
200088	TAI	TAAN	10.70 x	18.00 x	3.20
200293	TAE	TAAN	10.90 x	6.00 x	2.20
200379	TAE	TAAN	11.00 x	6.00 x	2.20
200087	TAI	TAAN	11.10 x	16.00 x	2.20
200004	TAI	TAAN	11.10 x	16.00 x	2.20
200699	TAE	TAAN	12.00 x	16.90 x	2.20
200168	TAE	TAAN	12.00 x	18.80 x	5.00
200700	TAE	TAAN	12.00 x	19.30 x	3.20
200008	TAI	TAAN	12.50 x	20.00 x	3.20
200090	TAI	TAAN	12.70 x	20.00 x	3.20
200294	TAE	TAAN	12.90 x	8.00 x	2.20
200380	TAE	TAAN	13.00 x	8.00 x	2.20
200701	TAE	TAAN	14.00 x	18.90 x	2.20
200169	TAE	TAAN	14.00 x	20.80 x	5.00
200702	TAE	TAAN	14.00 x	21.30 x	3.20
200011	TAI	TAAN	14.00 x	25.00 x	4.20
200093	TAI	TAAN	14.30 x	25.00 x	4.20
200009	TAI	TAAN	14.50 x	22.00 x	3.20
200091	TAI	TAAN	14.70 x	22.00 x	3.20
200296	TAE	TAAN	14.90 x	10.00 x	2.20
200381	TAE	TAAN	15.00 x	10.00 x	2.20
200170	TAE	TAAN	15.00 x	21.80 x	5.00
200703	TAE	TAAN	15.00 x	22.30 x	3.20
200089	TAI	TAAN	15.10 x	20.00 x	2.20
200007	TAI	TAAN	15.10 x	20.00 x	2.20
200421	TAE	TAAN	15.30 x	8.00 x	—
200295	TAE	TAAN	15.30 x	8.00 x	3.20
200171	TAE	TAAN	16.00 x	22.80 x	5.00
200704	TAE	TAAN	16.00 x	23.30 x	3.20
200298	TAE	TAAN	16.90 x	12.00 x	2.20
200382	TAE	TAAN	17.00 x	12.00 x	2.20

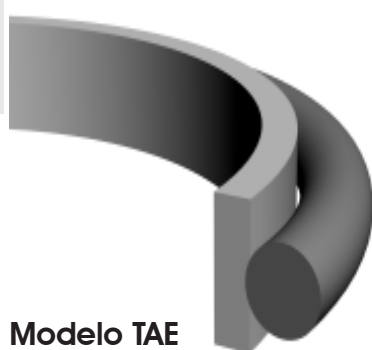

Modelo TAE

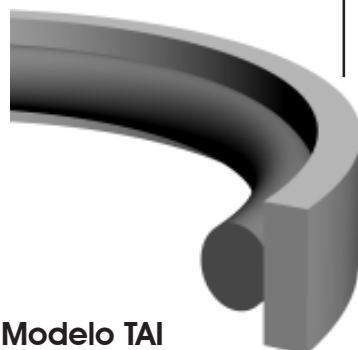

Modelo TAI





Código	Mod.	Mat.	Di x	De x	Ha1
200422	TAE	TAAN	17.30 x	10.00 x	—
200297	TAE	TAAN	17.30 x	10.00 x	3.20
200094	TAI	TAAN	17.30 x	28.00 x	4.20
200010	TAI	TAAN	17.50 x	25.00 x	3.20
200092	TAI	TAAN	17.70 x	25.00 x	3.20
200172	TAE	TAAN	18.00 x	24.80 x	5.00
200705	TAE	TAAN	18.00 x	25.30 x	3.20
200300	TAE	TAAN	18.90 x	14.00 x	2.20
200384	TAE	TAAN	19.00 x	14.00 x	2.20
200423	TAE	TAAN	19.30 x	12.00 x	—
200299	TAE	TAAN	19.30 x	12.00 x	3.20
200095	TAI	TAAN	19.30 x	30.00 x	4.20
200383	TAE	TAAN	19.50 x	12.00 x	3.20
200173	TAE	TAAN	20.00 x	26.80 x	5.00
200706	TAE	TAAN	20.00 x	27.30 x	3.20
200707	TAE	TAAN	20.00 x	30.70 x	4.20
200012	TAI	TAAN	20.50 x	28.00 x	3.20
200015	TAI	TAAN	21.00 x	32.00 x	4.20
200424	TAE	TAAN	21.30 x	14.00 x	—
200301	TAE	TAAN	21.30 x	14.00 x	3.20
200097	TAI	TAAN	21.30 x	32.00 x	4.20
200385	TAE	TAAN	21.50 x	14.00 x	3.20
200174	TAE	TAAN	22.00 x	28.80 x	5.00
200708	TAE	TAAN	22.00 x	29.30 x	3.20
200709	TAE	TAAN	22.00 x	32.70 x	4.20
200425	TAE	TAAN	22.30 x	15.00 x	—
200302	TAE	TAAN	22.30 x	15.00 x	3.20
200013	TAI	TAAN	22.50 x	30.00 x	3.20
200426	TAE	TAAN	23.30 x	16.00 x	—
200303	TAE	TAAN	23.30 x	16.00 x	3.20
200386	TAE	TAAN	23.50 x	16.00 x	3.20
200098	TAI	TAAN	24.30 x	35.00 x	4.20

Código	Mod.	Mat.	Di x	De x	Ha1
200014	TAI	TAAN	24.50 x	32.00 x	3.20
200096	TAI	TAAN	24.70 x	32.00 x	3.20
200175	TAE	TAAN	25.00 x	31.80 x	5.00
200710	TAE	TAAN	25.00 x	32.30 x	3.20
200711	TAE	TAAN	25.00 x	35.70 x	4.20
200427	TAE	TAAN	25.30 x	18.00 x	—
200304	TAE	TAAN	25.30 x	18.00 x	3.20
200387	TAE	TAAN	25.50 x	18.00 x	3.20
200306	TAE	TAAN	27.30 x	20.00 x	3.20
200388	TAE	TAAN	27.50 x	20.00 x	3.20
200016	TAI	TAAN	27.50 x	35.00 x	3.20
200230	TAE	TAAN	27.60 x	20.00 x	4.20
200176	TAE	TAAN	28.00 x	34.80 x	5.00
200712	TAE	TAAN	28.00 x	38.70 x	4.20
200018	TAI	TAAN	29.00 x	40.00 x	4.20
200307	TAE	TAAN	29.30 x	22.00 x	3.20
200100	TAI	TAAN	29.30 x	40.00 x	4.20
200390	TAE	TAAN	29.50 x	22.00 x	3.20
200231	TAE	TAAN	29.60 x	22.00 x	4.20
200177	TAE	TAAN	30.00 x	36.80 x	5.00
200713	TAE	TAAN	30.00 x	40.70 x	4.20
200428	TAE	TAAN	30.70 x	20.00 x	—
200305	TAE	TAAN	30.70 x	20.00 x	4.20
200389	TAE	TAAN	31.00 x	20.00 x	4.20
200019	TAI	TAAN	31.00 x	42.00 x	4.20
200101	TAI	TAAN	31.30 x	42.00 x	4.20
200178	TAE	TAAN	32.00 x	38.80 x	5.00
200714	TAE	TAAN	32.00 x	42.70 x	4.20
200309	TAE	TAAN	32.30 x	25.00 x	3.20
200392	TAE	TAAN	32.50 x	25.00 x	3.20
200017	TAI	TAAN	32.50 x	40.00 x	3.20
200232	TAE	TAAN	32.60 x	25.00 x	4.20

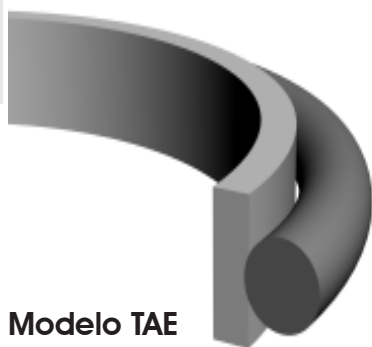

**Modelo TAE**

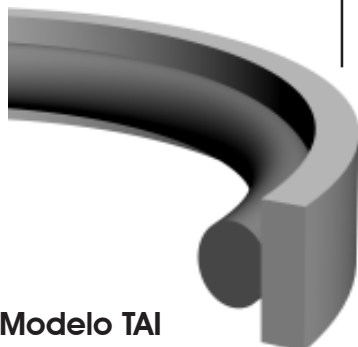

**Modelo TAI**



Código	Mod.	Mat.	Di x	De x	Ha1
200429	TAE	TAAN	32.70 x	22.00 x	—
200308	TAE	TAAN	32.70 x	22.00 x	4.20
200099	TAI	TAAN	32.70 x	40.00 x	3.20
200391	TAE	TAAN	33.00 x	22.00 x	4.20
200020	TAI	TAAN	34.00 x	45.00 x	4.20
200102	TAI	TAAN	34.30 x	45.00 x	4.20
200023	TAI	TAAN	34.50 x	50.00 x	6.30
200105	TAI	TAAN	34.90 x	50.00 x	6.30
200179	TAE	TAAN	35.00 x	41.80 x	5.00
200715	TAE	TAAN	35.00 x	45.70 x	4.20
200233	TAE	TAAN	35.60 x	28.00 x	4.20
200430	TAE	TAAN	35.70 x	25.00 x	—
200310	TAE	TAAN	35.70 x	25.00 x	4.20
200393	TAE	TAAN	36.00 x	25.00 x	4.20
200180	TAE	TAAN	36.00 x	42.80 x	5.00
200716	TAE	TAAN	36.00 x	46.70 x	4.20
200021	TAI	TAAN	37.00 x	48.00 x	4.20
200103	TAI	TAAN	37.30 x	48.00 x	4.20
200234	TAE	TAAN	37.60 x	30.00 x	4.20
200431	TAE	TAAN	38.70 x	28.00 x	—
200311	TAE	TAAN	38.70 x	28.00 x	4.20
200394	TAE	TAAN	39.00 x	28.00 x	4.20
200022	TAI	TAAN	39.00 x	50.00 x	4.20
200104	TAI	TAAN	39.30 x	50.00 x	4.20
200235	TAE	TAAN	39.60 x	32.00 x	4.20
200181	TAE	TAAN	40.00 x	46.80 x	5.00
200717	TAE	TAAN	40.00 x	50.70 x	4.20
200718	TAE	TAAN	40.00 x	55.10 x	6.30
200432	TAE	TAAN	40.70 x	30.00 x	—
200312	TAE	TAAN	40.70 x	30.00 x	4.20
200024	TAI	TAAN	41.00 x	52.00 x	4.20

Código	Mod.	Mat.	Di x	De x	Ha1
200106	TAI	TAAN	41.30 x	52.00 x	4.20
200182	TAE	TAAN	42.00 x	48.80 x	5.00
200719	TAE	TAAN	42.00 x	52.70 x	4.20
200720	TAE	TAAN	42.00 x	57.10 x	6.30
200236	TAE	TAAN	42.60 x	35.00 x	4.20
200433	TAE	TAAN	42.70 x	32.00 x	—
200313	TAE	TAAN	42.70 x	32.00 x	4.20
200395	TAE	TAAN	43.00 x	32.00 x	4.20
200237	TAE	TAAN	43.60 x	36.00 x	4.20
200025	TAI	TAAN	44.00 x	55.00 x	4.20
200107	TAI	TAAN	44.30 x	55.00 x	4.20
200108	TAI	TAAN	44.90 x	60.00 x	6.30
200183	TAE	TAAN	45.00 x	51.80 x	5.00
200721	TAE	TAAN	45.00 x	55.70 x	4.20
200722	TAE	TAAN	45.00 x	60.10 x	6.30
200434	TAE	TAAN	45.70 x	35.00 x	—
200314	TAE	TAAN	45.70 x	35.00 x	4.20
200435	TAE	TAAN	46.70 x	36.00 x	—
200315	TAE	TAAN	46.70 x	36.00 x	4.20
200396	TAE	TAAN	47.00 x	36.00 x	4.20
200028	TAI	TAAN	47.50 x	63.00 x	6.30
200110	TAI	TAAN	47.90 x	63.00 x	6.30
200184	TAE	TAAN	48.00 x	54.80 x	5.00
200723	TAE	TAAN	48.00 x	58.70 x	4.20
200724	TAE	NITR	48.00 x	63.10 x	6.30
200238	TAE	TAAN	48.80 x	40.00 x	6.30
200026	TAI	TAAN	49.00 x	60.00 x	4.20
200111	TAI	TAAN	49.90 x	65.00 x	6.30
200185	TAE	TAAN	50.00 x	56.80 x	5.00
200725	TAE	TAAN	50.00 x	60.70 x	4.20
200726	TAE	TAAN	50.00 x	65.10 x	6.30
200316	TAE	TAAN	50.70 x	40.00 x	4.20
200239	TAE	TAAN	50.80 x	42.00 x	6.30
200397	TAE	TAAN	51.00 x	40.00 x	4.20
200186	TAE	TAAN	52.00 x	58.80 x	5.00
200727	TAE	TAAN	52.00 x	62.70 x	4.20
200027	TAI	TAAN	52.00 x	63.00 x	4.20
200728	TAE	TAAN	52.00 x	67.10 x	6.30
200109	TAI	TAAN	52.30 x	63.00 x	4.20
200318	TAE	TAAN	52.70 x	42.00 x	4.20
200240	TAE	TAAN	53.80 x	45.00 x	6.30
200029	TAI	TAAN	54.00 x	65.00 x	6.30

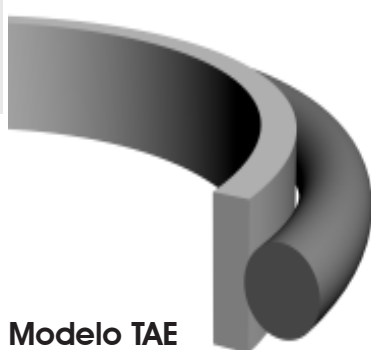

Modelo TAE

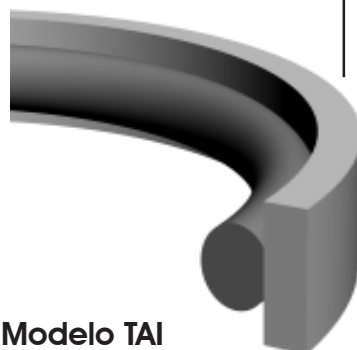

Modelo TAI



INCOVE VEDAÇÕES LTDA.

Código	Mod.	Mat.	Di x	De x	Ha1
200031	TAI	TAAN	54.50 x	70.00 x	6.30
200113	TAI	TAAN	54.90 x	70.00 x	6.30
200187	TAE	TAAN	55.00 x	61.80 x	5.00
200729	TAE	TAAN	55.00 x	65.70 x	4.20
200730	TAE	TAAN	55.00 x	70.10 x	6.30
200436	TAE	TAAN	55.10 x	40.00 x	—
200317	TAE	TAAN	55.10 x	40.00 x	6.30
200320	TAE	TAAN	55.70 x	45.00 x	4.20
200398	TAE	TAAN	56.00 x	45.00 x	4.20
200188	TAE	TAAN	56.00 x	62.80 x	5.00
200731	TAE	TAAN	56.00 x	66.70 x	4.20
200732	TAE	TAAN	56.00 x	71.10 x	6.30
200241	TAE	TAAN	56.80 x	48.00 x	6.30
200437	TAE	TAAN	57.10 x	42.00 x	6.30
200319	TAE	TAAN	57.10 x	42.00 x	6.30
200242	TAE	TAAN	58.80 x	50.00 x	6.30
200030	TAI	TAAN	59.00 x	70.00 x	4.20
200035	TAI	TAAN	59.00 x	80.00 x	8.10
200112	TAI	TAAN	59.30 x	70.00 x	4.20
200116	TAI	TAAN	59.50 x	80.00 x	8.10
200114	TAI	TAAN	59.90 x	75.00 x	6.30
200189	TAE	TAAN	60.00 x	66.80 x	5.00
200733	TAE	TAAN	60.00 x	70.70 x	4.20
200734	TAE	TAAN	60.00 x	75.10 x	6.30
200438	TAE	TAAN	60.10 x	45.00 x	6.30
200321	TAE	TAAN	60.10 x	45.00 x	6.30
200324	TAE	TAAN	60.70 x	50.00 x	4.20
200243	TAE	TAAN	60.80 x	52.00 x	6.30
200398	TAE	TAAN	61.00 x	50.00 x	4.20
200326	TAE	TAAN	62.70 x	52.00 x	4.20
200190	TAE	TAAN	63.00 x	69.80 x	5.00
200735	TAE	TAAN	63.00 x	73.70 x	4.20

Código	Mod.	Mat.	Di x	De x	Ha1
200736	TAE	TAAN	63.00 x	78.10 x	6.30
200439	TAE	TAAN	63.10 x	48.00 x	6.30
200323	TAE	TAAN	63.10 x	48.00 x	6.30
200244	TAE	TAAN	63.80 x	55.00 x	6.30
200032	TAI	TAAN	64.00 x	75.00 x	4.20
200037	TAI	TAAN	64.00 x	85.00 x	8.10
200034	TAI	TAAN	64.50 x	80.00 x	6.30
200118	TAI	TAAN	64.50 x	85.00 x	8.10
200245	TAE	TAAN	64.80 x	56.00 x	6.30
200115	TAI	TAAN	64.90 x	80.00 x	6.30
200191	TAE	TAAN	65.00 x	73.80 x	6.00
200737	TAE	TAAN	65.00 x	80.10 x	6.30
200440	TAE	TAAN	65.10 x	50.00 x	6.30
200325	TAE	TAAN	65.10 x	50.00 x	6.30
200328	TAE	TAAN	65.70 x	55.00 x	4.20
200330	TAE	TAAN	66.70 x	56.00 x	4.20
200400	TAE	TAAN	67.00 x	56.00 x	4.20
200441	TAE	TAAN	67.10 x	52.00 x	6.30
200327	TAE	TAAN	67.10 x	52.00 x	6.30
200246	TAE	TAAN	68.80 x	60.00 x	6.30
200033	TAI	TAAN	69.00 x	80.00 x	4.20
200039	TAI	TAAN	69.00 x	90.00 x	8.10
200036	TAI	TAAN	69.50 x	85.00 x	6.30
200120	TAI	TAAN	69.50 x	90.00 x	8.10
200117	TAI	TAAN	69.90 x	85.00 x	6.30
200192	TAE	TAAN	70.00 x	78.80 x	6.00
200738	TAE	TAAN	70.00 x	85.10 x	6.30
200442	TAE	TAAN	70.10 x	55.00 x	6.30
200329	TAE	TAAN	70.10 x	55.00 x	6.30
200332	TAE	TAAN	70.70 x	60.00 x	4.20
200443	TAE	TAAN	71.10 x	56.00 x	6.30
200331	TAE	TAAN	71.10 x	56.00 x	6.30
200401	TAE	TAAN	71.50 x	56.00 x	6.30
200247	TAE	TAAN	71.80 x	63.00 x	6.30
200334	TAE	TAAN	73.70 x	63.00 x	4.20
200248	TAE	TAAN	73.80 x	65.00 x	6.30
200402	TAE	TAAN	74.00 x	63.00 x	4.20
200041	TAI	TAAN	74.00 x	95.00 x	8.10
200038	TAI	TAAN	74.50 x	90.00 x	6.30
200122	TAI	TAAN	74.50 x	95.00 x	8.10
200119	TAI	TAAN	74.90 x	90.00 x	6.30
200193	TAE	TAAN	75.00 x	83.80 x	6.00
200739	TAE	TAAN	75.00 x	90.10 x	6.30
200444	TAE	TAAN	75.10 x	60.00 x	6.30
200333	TAE	TAAN	75.10 x	60.00 x	6.30

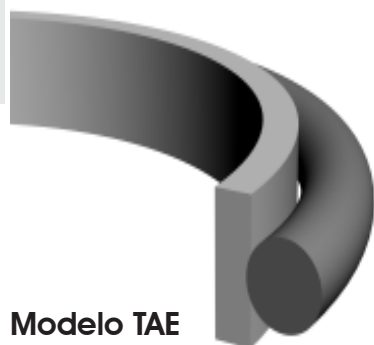

Modelo TAE

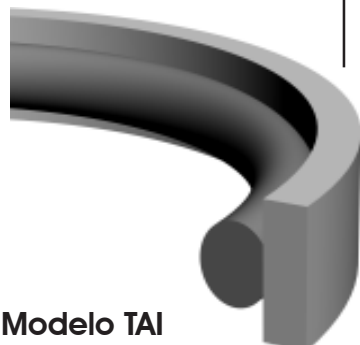

Modelo TAI



Código	Mod.	Mat.	Di x	De x	Ha1
200445	TAE	TAAN	78.10 x	63.00 x	6.30
200335	TAE	TAAN	78.10 x	63.00 x	6.30
200403	TAE	TAAN	78.50 x	63.00 x	6.30
200040	TAI	TAAN	79.50 x	95.00 x	6.30
200124	TAI	TAAN	79.50 x	100.00 x	8.10
200121	TAI	TAAN	79.90 x	95.00 x	6.30
200194	TAE	TAAN	80.00 x	88.80 x	6.00
200740	TAE	TAAN	80.00 x	95.10 x	6.30
200123	TAI	TAAN	84.90 x	100.00 x	6.30
200195	TAE	TAAN	85.00 x	93.80 x	6.00
200446	TAE	TAAN	80.10 x	65.00 x	6.30
200336	TAE	TAAN	80.10 x	65.00 x	6.30
200249	TAE	TAAN	82.20 x	70.00 x	8.10
200042	TAI	TAAN	84.50 x	100.00 x	6.30
200126	TAI	TAAN	84.50 x	105.00 x	8.10
200741	TAE	TAAN	85.00 x	100.10 x	6.30
200447	TAE	TAAN	85.10 x	70.00 x	6.30
200337	TAE	TAAN	85.10 x	70.00 x	6.30
200404	TAE	TAAN	85.50 x	70.00 x	6.30
200250	TAE	TAAN	87.20 x	75.00 x	8.10
200128	TAI	TAAN	89.50 x	110.00 x	8.10
200125	TAI	TAAN	89.90 x	105.00 x	6.30
200196	TAE	TAAN	90.00 x	98.80 x	6.00
200742	TAE	TAAN	90.00 x	105.10 x	6.30
200448	TAE	TAAN	90.10 x	75.00 x	6.30
200338	TAE	TAAN	90.10 x	75.00 x	6.30
200251	TAE	TAAN	92.20 x	80.00 x	8.10
200130	TAI	TAAN	94.50 x	115.00 x	8.10
200127	TAI	TAAN	94.90 x	110.00 x	6.30
200197	TAE	TAAN	95.00 x	103.80 x	6.00
200743	TAE	TAAN	95.00 x	110.10 x	6.30
200449	TAE	TAAN	95.10 x	80.00 x	6.30
200339	TAE	TAAN	95.10 x	80.00 x	6.30

Código	Mod.	Mat.	Di x	De x	Ha1
200405	TAE	TAAN	95.50 x	80.00 x	6.30
200252	TAE	TAAN	97.20 x	85.00 x	8.10
200132	TAI	TAAN	99.50 x	120.00 x	8.10
200129	TAI	TAAN	99.90 x	115.00 x	6.30
200198	TAE	TAAN	100.00 x	108.80 x	6.00
200744	TAE	TAAN	100.00 x	115.10 x	6.30
200450	TAE	TAAN	100.10 x	85.00 x	6.30
200340	TAE	TAAN	100.10 x	85.00 x	6.30
200253	TAE	TAAN	102.20 x	90.00 x	8.10
200134	TAI	TAAN	104.50 x	125.00 x	8.10
200131	TAI	TAAN	104.90 x	120.00 x	6.30
200199	TAE	TAAN	105.00 x	113.80 x	6.00
200745	TAE	TAAN	105.00 x	120.10 x	6.30
200451	TAE	TAAN	105.10 x	90.00 x	6.30
200341	TAE	TAAN	105.10 x	90.00 x	6.30
200406	TAE	TAAN	105.50 x	90.00 x	6.30
200254	TAE	TAAN	107.20 x	95.00 x	8.10
200136	TAI	TAAN	109.50 x	130.00 x	8.10
200133	TAI	TAAN	109.90 x	125.00 x	6.30
200200	TAE	TAAN	110.00 x	118.80 x	6.00
200746	TAE	TAAN	110.00 x	125.10 x	6.30
200452	TAE	TAAN	110.10 x	95.00 x	6.30
200342	TAE	TAAN	110.10 x	95.00 x	6.30
200255	TAE	TAAN	112.20 x	100.00 x	8.10
200137	TAI	TAAN	114.50 x	135.00 x	8.10
200135	TAI	TAAN	114.90 x	130.00 x	6.30
200201	TAE	TAAN	115.00 x	123.80 x	6.00
200747	TAE	TAAN	115.00 x	130.10 x	6.30
200453	TAE	TAAN	115.10 x	100.00 x	6.30
200343	TAE	TAAN	115.10 x	100.00 x	6.30
200407	TAE	TAAN	115.50 x	100.00 x	6.30
200256	TAE	TAAN	117.20 x	105.00 x	8.10
200138	TAI	TAAN	119.50 x	140.00 x	8.10
200202	TAE	TAAN	120.00 x	128.80 x	6.00
200748	TAE	TAAN	120.00 x	135.10 x	6.30
200454	TAE	TAAN	120.10 x	105.00 x	6.30
200344	TAE	TAAN	120.10 x	105.00 x	6.30
200257	TAE	TAAN	122.20 x	110.00 x	8.10
200203	TAE	TAAN	125.00 x	133.80 x	6.00
200749	TAE	TAAN	125.00 x	140.10 x	6.30

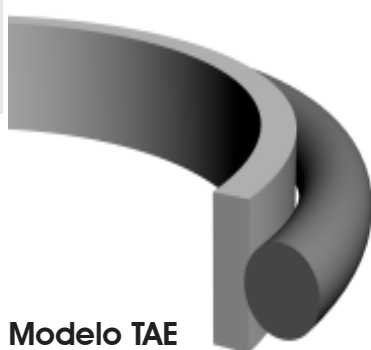

Modelo TAE

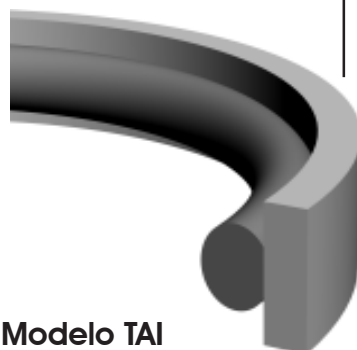

Modelo TAI



INCOLVE VEDAÇÕES LTDA.

Código	Mod.	Mat.	Di x	De x	Ha1
200455	TAE	TAAN	125.10 x	110.00 x	6.30
200345	TAE	TAAN	125.10 x	110.00 x	6.30
200408	TAE	TAAN	125.50 x	110.00 x	6.30
200258	TAE	TAAN	127.20 x	115.00 x	8.10
200139	TAI	TAAN	129.50 x	150.00 x	8.10
200204	TAE	TAAN	130.00 x	138.80 x	6.00
200750	TAE	TAAN	130.00 x	145.10 x	6.30
200456	TAE	TAAN	130.10 x	115.00 x	6.30
200346	TAE	TAAN	130.10 x	115.00 x	6.30
200259	TAE	TAAN	132.20 x	120.00 x	8.10
200205	TAE	TAAN	135.00 x	143.80 x	6.00
200751	TAE	TAAN	135.00 x	150.10 x	6.30
200457	TAE	TAAN	135.10 x	120.00 x	6.30
200347	TAE	TAAN	135.10 x	120.00 x	6.30
200260	TAE	TAAN	137.20 x	125.00 x	8.10
200141	TAI	TAAN	139.50 x	160.00 x	8.10
200206	TAE	TAAN	140.00 x	148.80 x	6.00
200752	TAE	TAAN	140.00 x	155.10 x	6.30
200458	TAE	TAAN	140.10 x	125.00 x	6.30
200348	TAE	TAAN	140.10 x	125.00 x	6.30
200409	TAE	TAAN	140.50 x	125.00 x	6.30
200261	TAE	TAAN	142.20 x	130.00 x	8.10
200140	TAI	TAAN	144.90 x	160.00 x	6.30
200459	TAE	TAAN	145.10 x	130.00 x	6.30
200349	TAE	TAAN	145.10 x	130.00 x	6.30
200262	TAE	TAAN	147.20 x	135.00 x	8.10
200142	TAI	TAAN	149.50 x	170.00 x	8.10
200207	TAE	TAAN	150.00 x	158.80 x	6.00
200753	TAE	TAAN	150.00 x	165.10 x	6.30
200460	TAE	TAAN	150.10 x	135.00 x	6.30
200350	TAE	TAAN	150.10 x	135.00 x	6.30
200461	TAE	TAAN	155.10 x	140.00 x	6.30
200351	TAE	TAAN	155.10 x	140.00 x	6.30
200410	TAE	TAAN	155.50 x	140.00 x	6.30
200263	TAE	TAAN	156.00 x	140.00 x	9.50

Código	Mod.	Mat.	Di x	De x	Ha1
200143	TAI	TAAN	159.50 x	180.00 x	8.10
200208	TAE	TAAN	160.00 x	168.80 x	6.00
200754	TAE	TAAN	160.00 x	175.10 x	6.30
200755	TAE	TAAN	160.00 x	180.50 x	8.10
200462	TAE	TAAN	165.10 x	150.00 x	6.30
200352	TAE	TAAN	165.10 x	150.00 x	6.30
200264	TAE	TAAN	166.00 x	150.00 x	9.50
200144	TAI	TAAN	169.50 x	190.00 x	8.10
200209	TAE	TAAN	170.00 x	178.80 x	6.00
200756	TAE	TAAN	170.00 x	185.10 x	6.30
200463	TAE	TAAN	175.10 x	160.00 x	6.30
200353	TAE	TAAN	175.10 x	160.00 x	6.30
200411	TAE	TAAN	175.50 x	160.00 x	6.30
200265	TAE	TAAN	176.00 x	160.00 x	9.50
200146	TAI	TAAN	179.50 x	200.00 x	8.10
200210	TAE	TAAN	180.00 x	188.80 x	6.00
200757	TAE	TAAN	180.00 x	195.10 x	6.30
200758	TAE	TAAN	180.00 x	200.50 x	8.10
200354	TAE	TAAN	180.50 x	160.00 x	8.10
200412	TAE	TAAN	181.00 x	160.00 x	8.10
200145	TAI	TAAN	184.90 x	200.00 x	6.30
200464	TAE	TAAN	185.10 x	170.00 x	6.30
20355	TAE	TAAN	185.10 x	170.00 x	6.30
200266	TAE	TAAN	186.00 x	170.00 x	9.50
200147	TAI	TAAN	189.50 x	210.00 x	8.10
200211	TAE	TAAN	190.00 x	198.80 x	6.00
200759	TAE	TAAN	190.00 x	205.10 x	6.30
200465	TAE	TAAN	195.10 x	180.00 x	6.30
200356	TAE	TAAN	195.10 x	180.00 x	6.30
200413	TAE	TAAN	195.50 x	180.00 x	6.30
200267	TAE	TAAN	196.00 x	180.00 x	9.50
200148	TAI	TAAN	199.50 x	220.00 x	8.10
200212	TAE	TAAN	200.00 x	208.80 x	6.00
200827	UESP	NITR	200.00 x	212.20 x	9.50
200760	TAE	TAAN	200.00 x	220.50 x	8.10
200357	TAE	TAAN	200.50 x	180.00 x	8.10
200414	TAE	TAAN	201.00 x	180.00 x	8.10
200466	TAE	TAAN	205.10 x	190.00 x	6.30
200358	TAE	TAAN	205.10 x	190.00 x	6.30
200268	TAE	TAAN	206.00 x	190.00 x	9.50
200149	TAI	TAAN	209.50 x	230.00 x	8.10
200213	TAE	TAAN	210.00 x	218.80 x	6.00
200761	TAE	TAAN	210.00 x	230.50 x	8.10
200269	TAE	TAAN	216.00 x	200.00 x	9.50
200150	TAI	TAAN	219.50 x	240.00 x	8.10
200214	TAE	TAAN	220.00 x	228.80 x	6.00
200762	TAE	TAAN	220.00 x	240.50 x	8.10
200467	TAE	TAAN	220.50 x	200.00 x	8.10
200359	TAE	TAAN	220.50 x	200.00 x	8.10
200415	TAE	TAAN	221.00 x	200.00 x	8.10
200270	TAE	TAAN	226.00 x	210.00 x	9.50
200152	TAI	TAAN	226.00 x	250.00 x	8.10
200151	TAI	TAAN	229.50 x	250.00 x	8.10
200215	TAE	TAAN	230.00 x	238.80 x	6.00
200763	TAE	TAAN	230.00 x	250.50 x	8.10
200468	TAE	TAAN	230.50 x	210.00 x	8.10
200360	TAE	TAAN	230.50 x	210.00 x	8.10

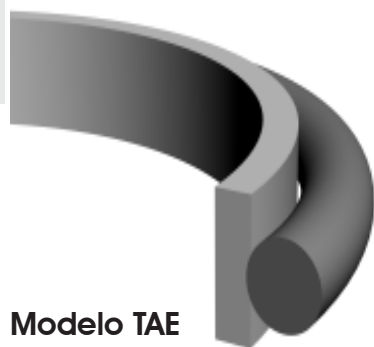

Modelo TAE

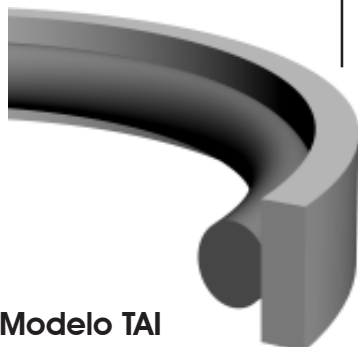

Modelo TAI





Código	Mod.	Mat.	Di x	De x	Ha1
200271	TAE	TAAN	236.00 x	220.00 x	9.50
200216	TAE	TAAN	240.00 x	248.80 x	6.00
200764	TAE	TAAN	240.00 x	260.50 x	8.10
200469	TAE	TAAN	240.50 x	220.00 x	8.10
200361	TAE	TAAN	240.50 x	220.00 x	8.10
200416	TAE	TAAN	241.00 x	220.00 x	8.10
200272	TAE	TAAN	246.00 x	230.00 x	9.50
200217	TAE	TAAN	250.00 x	258.80 x	6.00
200765	TAE	TAAN	250.00 x	270.50 x	8.10
200470	TAE	TAAN	250.50 x	230.00 x	8.10
200362	TAE	TAAN	250.50 x	230.00 x	8.10
200273	TAE	TAAN	256.00 x	240.00 x	9.50
200153	TAI	TAAN	256.00 x	280.00 x	8.10
200218	TAE	TAAN	260.00 x	272.20 x	8.40
200471	TAE	TAAN	260.50 x	240.00 x	8.10
200363	TAE	TAAN	260.50 x	240.00 x	8.10
200274	TAE	TAAN	266.00 x	250.00 x	9.50
200472	TAE	TAAN	270.50 x	250.00 x	8.10
200364	TAE	TAAN	270.50 x	250.00 x	8.10
200417	TAE	TAAN	271.00 x	250.00 x	8.10
200275	TAE	TAAN	276.00 x	260.00 x	9.50
200154	TAI	TAAN	276.00 x	300.00 x	8.10
200219	TAE	TAAN	280.00 x	292.20 x	8.40
200766	TAE	TAAN	280.00 x	304.00 x	8.10
200276	TAE	TAAN	296.00 x	280.00 x	9.50
200156	TAI	TAAN	296.00 x	320.00 x	8.10
200155	TAI	TAAN	299.50 x	320.00 x	8.10
200220	TAE	TAAN	300.00 x	312.20 x	8.40
200767	TAE	TAAN	300.00 x	324.00 x	8.10
200473	TAE	TAAN	304.00 x	280.00 x	8.10
200365	TAE	TAAN	304.00 x	280.00 x	8.10
200418	TAE	TAAN	304.50 x	280.00 x	8.10
200277	TAE	TAAN	316.00 x	300.00 x	9.50
200221	TAE	TAAN	320.00 x	332.20 x	8.40
200768	TAE	TAAN	320.00 x	344.00 x	8.10
200474	TAE	TAAN	324.00 x	300.00 x	8.10
200366	TAE	TAAN	324.00 x	300.00 x	8.10
200157	TAI	TAAN	326.00 x	350.00 x	8.10
200278	TAE	TAAN	336.00 x	320.00 x	9.50
200475	TAE	TAAN	344.00 x	320.00 x	8.10
200367	TAE	TAAN	344.00 x	320.00 x	8.10

Código	Mod.	Mat.	Di x	De x	Ha1
200419	TAE	TAAN	344.50 x	320.00 x	8.10
200222	TAE	TAAN	350.00 x	362.20 x	8.40
200769	TAE	TAAN	350.00 x	374.00 x	8.10
200223	TAE	TAAN	360.00 x	372.20 x	8.40
200770	TAE	TAAN	360.00 x	384.00 x	8.10
200279	TAE	TAAN	366.00 x	350.00 x	9.50
200476	TAE	TAAN	374.00 x	350.00 x	8.10
200368	TAE	TAAN	374.00 x	350.00 x	8.10
200280	TAE	TAAN	376.00 x	360.00 x	9.50
200158	TAI	TAAN	376.00 x	400.00 x	8.10
200477	TAE	TAAN	384.00 x	360.00 x	8.10
200369	TAE	TAAN	384.00 x	360.00 x	8.10
200420	TAE	TAAN	384.50 x	360.00 x	8.10
200159	TAI	TAAN	396.00 x	420.00 x	8.10
200224	TAE	TAAN	400.00 x	412.20 x	8.40
200771	TAE	TAAN	400.00 x	424.00 x	8.10
200772	TAE	TAAN	420.00 x	444.00 x	8.10
200478	TAE	TAAN	424.00 x	400.00 x	8.10
200370	TAE	TAAN	424.00 x	400.00 x	8.10
200281	TAE	TAAN	424.00 x	400.00 x	14.00
200160	TAI	TAAN	426.00 x	450.00 x	8.10
200371	TAE	TAAN	444.00 x	420.00 x	8.10
200479	TAE	TAAN	444.00 x	420.00 x	8.10
200773	TAE	TAAN	450.00 x	474.00 x	8.10
200161	TAI	TAAN	456.00 x	480.00 x	8.10
200480	TAE	TAAN	474.00 x	450.00 x	8.10
200372	TAE	TAAN	474.00 x	450.00 x	8.10
200162	TAI	TAAN	476.00 x	500.00 x	8.10
200774	TAE	TAAN	480.00 x	504.00 x	8.10
200775	TAE	TAAN	500.00 x	524.00 x	8.10
200481	TAE	TAAN	504.00 x	480.00 x	8.10
200373	TAE	TAAN	504.00 x	480.00 x	8.10
200482	TAE	TAAN	524.00 x	500.00 x	8.10
200374	TAE	TAAN	524.00 x	500.00 x	8.10
200282	TAE	TAAN	524.00 x	500.00 x	14.00
200163	TAI	TAAN	576.00 x	600.00 x	8.10
200776	TAE	TAAN	600.00 x	624.00 x	8.10
200483	TAE	TAAN	624.00 x	600.00 x	8.10
200375	TAE	TAAN	624.00 x	600.00 x	8.10
200283	TAE	TAAN	624.00 x	600.00 x	14.00
200164	TAI	TAAN	672.70 x	700.00 x	9.50
200284	TAE	TAAN	727.30 x	700.00 x	16.00

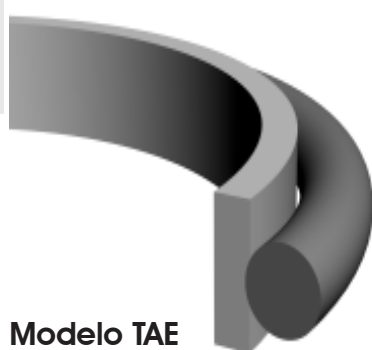

Modelo TAE

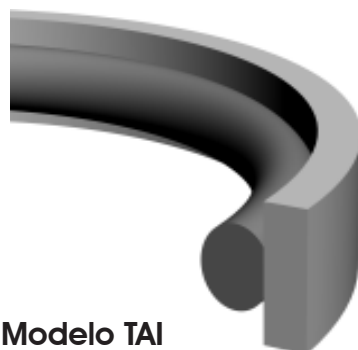

Modelo TAI



**INCOVE**<sup>®</sup>

INCOVE VEDAÇÕES LTDA.

**QU**ad'ring



# Quad'Ring



INCOVE VEDAÇÕES LTDA.

Código	Di x	De x	Ha1	Código	Di x	De x	Ha1	Código	Di x	De x	Ha1	Código	Di x	De x	Ha1
F6714	4.50 x	8.10 x	1.80	F11317	16.00 x	21.30 x	2.65	F15989	30.00 x	40.00 x	5.00	F9828	49.00 x	60.00 x	5.50
F2976	5.50 x	9.00 x	2.00	F11317	16.00 x	21.30 x	2.65	F15030	30.00 x	40.00 x	7.00	F14371	50.00 x	58.00 x	4.00
F14786	5.50 x	10.00 x	3.00	F13352	16.00 x	22.00 x	3.00	F2654	30.30 x	38.00 x	3.60	F1925	50.00 x	60.00 x	2.50
F14800	5.50 x	10.00 x	3.00	F1389	16.00 x	23.80 x	4.20	F13536	31.50 x	36.50 x	2.50	F12848	50.00 x	60.00 x	5.00
F6454	5.70 x	9.26 x	1.70	F15028	16.00 x	24.00 x	5.50	F6739	31.75 x	40.75 x	4.50	F5580/1	50.20 x	60.80 x	5.30
F6217/1	5.70 x	10.70 x	2.50	F12604	16.70 x	24.00 x	1.50	F10568	32.00 x	39.00 x	3.50	F6524/2	50.50 x	57.50 x	3.50
F8541	6.35 x	14.28 x	3.17	F7709	17.12 x	22.36 x	2.65	F10508	32.00 x	39.00 x	3.50	F6524/2	50.50 x	57.50 x	3.50
F7484	6.50 x	10.50 x	2.00	F8586/1	17.80 x	23.00 x	2.60	F7518/1	32.00 x	40.00 x	4.00	F11925	50.80 x	55.40 x	2.30
F13296	7.24 x	83.06 x	5.33	F7461	18.00 x	24.00 x	3.00	F11880	32.00 x	40.00 x	5.00	F1092	50.80 x	60.80 x	5.00
F5311	8.50 x	11.50 x	1.80	F8159	18.50 x	22.50 x	2.00	F7708	33.00 x	40.00 x	3.50	F1517	52.00 x	60.00 x	3.80
F6745	8.50 x	11.90 x	3.20	F5278	18.50 x	23.90 x	2.70	F6524/1	33.00 x	41.00 x	4.00	F15129	52.00 x	60.00 x	4.00
F12609	8.50 x	13.40 x	1.50	F7824/2	18.50 x	25.50 x	3.50	F9828/1	33.50 x	40.00 x	4.50	F15557	52.00 x	62.00 x	5.00
F7358	9.20 x	14.40 x	2.60	F7744	19.00 x	25.00 x	3.00	F11618	34.00 x	42.00 x	4.00	F10965	52.40 x	59.40 x	3.55
F6446	9.25 x	12.81 x	1.78	F7744	19.00 x	25.00 x	3.00	F8012/1	34.52 x	41.58 x	3.53	F6636/2	52.50 x	62.50 x	5.00
F8428	9.50 x	15.10 x	2.80	F3216	19.00 x	25.20 x	2.80	F8012/1	34.52 x	41.58 x	3.53	F6237	53.35 x	64.10 x	5.33
F1912	9.52 x	14.29 x	2.38	F3674	19.00 x	26.20 x	3.60	F8012/1	34.52 x	41.58 x	3.55	F6237	53.35 x	64.10 x	5.33
F16781	10.00 x	13.00 x	1.80	F8948	19.30 x	25.40 x	3.50	F13535	35.00 x	38.40 x	1.70	F10696	53.57 x	60.63 x	3.53
F13382	10.00 x	15.60 x	2.80	F10695	20.00 x	27.00 x	3.50	F6791	35.00 x	41.00 x	3.00	F10119	53.97 x	63.49 x	4.76
F7708/1	10.20 x	15.45 x	2.65	F17243	20.00 x	28.50 x	4.25	F13253	35.00 x	42.20 x	3.60	F3011	53.97 x	63.50 x	5.16
F12605	10.40 x	16.00 x	2.00	F12723	20.00 x	30.00 x	5.00	F2185	35.00 x	43.00 x	3.70	F9538	54.00 x	59.00 x	2.50
F10649	10.50 x	15.80 x	2.62	F8085	20.22 x	27.28 x	3.53	F2253	35.00 x	45.00 x	5.00	F6217	54.50 x	65.16 x	5.30
F17174	10.82 x	14.38 x	1.78	F11457	20.40 x	25.80 x	2.70	F11490	35.50 x	41.50 x	4.20	F7518/2	55.00 x	65.00 x	5.00
F12689	11.11 x	15.87 x	2.80	F10896	20.50 x	25.50 x	2.50	F11350	36.00 x	43.00 x	3.50	F13724	56.50 x	63.50 x	3.50
F4699	11.50 x	17.50 x	2.80	F10308	21.00 x	26.00 x	2.70	F5952/1	36.00 x	44.00 x	4.00	F15565	56.50 x	67.16 x	5.33
F13495	11.50 x	32.00 x	16.00	F12014	21.50 x	28.50 x	3.50	F12757	37.00 x	45.00 x	4.00	F8855/2	58.00 x	64.00 x	3.00
F11144	11.70 x	16.90 x	3.60	F6572	21.50 x	28.50 x	3.50	F8586/2	37.70 x	44.80 x	3.55	F6899	58.00 x	65.00 x	3.50
F15608	11.90 x	19.00 x	3.50	F10830	21.50 x	28.50 x	3.50	F13537	38.00 x	43.00 x	2.50	F14008	58.00 x	66.00 x	4.00
F7290/2	12.00 x	17.00 x	2.50	F12608	21.50 x	28.60 x	2.30	F6867	38.00 x	44.20 x	3.10	F17138	58.00 x	68.00 x	5.60
F8400	12.00 x	18.00 x	3.00	F8297/2	21.82 x	28.88 x	3.55	F2548	38.00 x	44.50 x	3.30	F12716	58.00 x	68.50 x	5.80
F15608	12.00 x	19.00 x	3.50	F8297/2	21.82 x	28.88 x	3.55	F2857	38.00 x	45.60 x	3.80	F14700	58.00 x	70.00 x	6.00
F15027	12.00 x	20.00 x	5.50	F2173	22.00 x	28.50 x	3.80	F7076	38.00 x	48.00 x	5.00	F7824/1	59.50 x	66.50 x	3.50
F5818	12.37 x	17.61 x	2.62	F1511	22.00 x	29.40 x	3.20	F5972	39.20 x	49.85 x	5.33	F8305	59.70 x	70.36 x	5.30
F15864	12.42 x	15.98 x	1.78	F4533	22.22 x	28.57 x	3.17	F6596	39.60 x	50.50 x	5.30	F8249/1	59.70 x	70.36 x	5.30
F13320	13.00 x	17.00 x	2.00	F9944	22.80 x	28.37 x	2.78	F6596	39.60 x	50.50 x	5.30	F6679	60.00 x	70.00 x	5.00
F12236	13.00 x	18.00 x	2.50	F11976	23.00 x	34.80 x	5.50	F6315	40.00 x	46.00 x	3.00	F6679	60.00 x	70.00 x	5.00
F12606	13.00 x	18.50 x	3.00	F5334	23.50 x	30.50 x	3.50	F8486	40.00 x	46.00 x	4.00	F9383/2	60.00 x	71.00 x	5.50
F6777	13.00 x	22.00 x	2.50	F4512	23.70 x	30.70 x	3.50	F5330	40.00 x	50.00 x	5.00	F7680	61.50 x	72.20 x	5.30
F15946	13.60 x	17.00 x	1.80	F675	24.60 x	32.80 x	4.00	F15029	40.00 x	50.00 x	7.00	F3709	62.00 x	72.00 x	5.00
F11167	13.80 x	17.80 x	2.00	F675	24.60 x	32.80 x	4.00	F3635	40.00 x	51.00 x	5.50	F5581	62.90 x	73.50 x	5.30
F8182	13.95 x	19.19 x	2.62	F5041	24.80 x	32.60 x	4.00	F5581/1	40.60 x	51.30 x	5.30	F8012	63.00 x	70.00 x	3.50
F6868/2	14.00 x	17.30 x	1.65	F8249/2	25.00 x	32.06 x	3.55	F1173	41.00 x	48.00 x	3.50	F7007/1	63.40 x	70.00 x	3.30
F9552	14.00 x	19.40 x	2.70	F8249/2	25.00 x	32.06 x	3.55	F5076	41.00 x	50.80 x	5.70	F14372	63.50 x	71.50 x	4.00
F10713	14.00 x	20.00 x	3.00	F6330	25.00 x	32.20 x	3.60	F9318	41.00 x	51.00 x	5.00	F11027	63.50 x	76.20 x	6.35
F14675	14.00 x	24.00 x	5.10	F15026	25.00 x	35.00 x	7.00	F14097	41.80 x	37.40 x	2.20	F6402	64.00 x	76.00 x	6.00
F5365	14.29 x	19.05 x	2.38	F8181	25.40 x	31.75 x	3.17	F14097/1	41.80 x	37.40 x	2.20	F1555	65.88 x	76.20 x	5.16
F3708	14.50 x	20.00 x	2.80	F8181	25.40 x	31.75 x	3.17	F14868	42.00 x	48.00 x	3.50	F6843	66.00 x	76.60 x	5.30
F6453	14.70 x	19.94 x	2.60	F1454	25.40 x	31.75 x	3.97	F12649	43.00 x	50.00 x	3.50	F8994	66.00 x	80.00 x	7.00
F8249/4	14.90 x	20.14 x	2.65	F7007/2	25.40 x	32.00 x	3.30	F13159	43.00 x	50.00 x	3.50	F5839	66.67 x	73.01 x	3.17
F7708/2	14.90 x	20.14 x	2.65	F10006	25.40 x	33.32 x	3.90	F7614	43.80 x	54.50 x	5.30	F6537	68.00 x	75.00 x	4.00
F8330/2	14.95 x	19.19 x	2.65	F4393	26.50 x	33.70 x	3.60	F5582	43.80 x	54.50 x	5.30	F9534	68.00 x	79.00 x	5.50
F14505	15.00 x	21.00 x	3.00	F12607	26.70 x	35.00 x	2.50	F13159	44.00 x	51.00 x	3.50	F8994/1	69.00 x	76.00 x	3.50
F5736	15.40 x	21.00 x	2.80	F4695	26.99 x	34.79 x	3.90	F12160	44.40 x	53.90 x	4.76	F7615	69.20 x	73.50 x	5.30
F7140	15.50 x	20.50 x	2.50	F16910	27.00 x	32.00 x	4.00	F5739	44.90 x	55.10 x	5.00	F9522	69.20 x	79.86 x	5.33
F7587	15.50 x	20.70 x	2.60	F7290/1	27.00 x	34.00 x	3.50	F5738	44.90 x	55.60 x	5.00	F5542	69.20 x	79.86 x	5.33
F717	15.50 x	22.50 x	3.50	F16830	27.00 x	35.00 x	4.50	F4767-A	45.00 x	55.00 x	5.00	F4767/B	70.00 x	80.00 x	5.00
F6984/1	28.00 x	35.00 x	3.50	F6984/1	28.00 x	35.00 x	3.50	F9325	45.00 x	56.00 x	5.50	F5075	70.00 x	81.00 x	6.00
F2318	29.00 x	36.00 x	3.50	F2318	29.00 x	36.00 x	3.50	F9325	45.00 x	56.00 x	5.50	F13296	72.40 x	83.06 x	5.33
F11318	29.40 x	40.00 x	5.30	F11318	29.40 x	40.00 x	5.30	F8249/3	45.20 x	55.85 x	5.30	F10278	74.00 x	85.00 x	5.50
F11318	29.40 x	40.00 x	5.30	F11318	29.40 x	40.00 x	5.30	F8249/3	45.20 x	55.85 x	5.30	F2063	75.00 x	85.00 x	5.00
F15840	29.75 x	35.81 x	3.53	F15840	29.75 x	35.81 x	3.53	F8330/1	46.00 x	52.00 x	3.00	F9100/1	75.00 x	87.00 x	6.00
F6539	29.80 x	36.70 x	4.00	F6539	29.80 x	36.70 x	4.00	F6636/1	46.50 x	56.50 x	5.50	F11109	75.50 x	82.50 x	3.50
F10683	30.00 x	34.80 x	2.40	F10683	30.00 x	34.80 x	2.40	F5187	47.00 x	57.60 x	5.30	F7964	75.56 x	86.22 x	5.33
F12648	30.00 x	36.00 x	3.00	F12648	30.00 x	36.00 x	3.00	F13437	47.30 x	50.90 x	1.78	F7745	78.75 x	89.41 x	5.30
F13093	30.00 x	36.00 x	3.00	F13093	30.00 x	36.00 x	3.00	F9383/1	48.00 x	58.00 x	5.00	F12131	79.50 x	86.50 x	3.50
F5580/2	30.00 x	37.00 x	3.50	F5580/2	30.00 x	37.00 x	3.50	F12647	48.00 x	58.00 x	6.00	F5676	80.00 x	88.00 x	4.00
F9471	30.00 x	37.00 x	3.80	F9471	30.00 x	37.00 x	3.80	F12647	48.00 x	58.00 x	6.00	F2064	80.00 x	90.00 x	5.00
F15051	30.00 x	39.00 x	4.50	F15051	30.00 x	39.00 x	4.50	F6868/1	48.50 x	54.10 x	2.80	F9534/1	80.00 x	91.00 x	5.50





# Quad'Ring



INCOVE VEDAÇÕES LTDA.

Código	Di x	De x	Ha1	Código	Di x	De x	Ha1	Código	Di x	De x	Ha1	Código	Di x	De x	Ha1
F128	82.00	x 89.00	x 3.50	F13378	107.30	x 117.90	x 5.30	F6307/1	142.25	x 156.25	x 7.00	F1170	215.00	x 229.00	x 7.00
F14730	82.00	x 90.00	x 4.00	F15952	108.00	x 115.00	x 3.50	F15036	145.00	x 155.00	x 5.00	F1170	216.00	x 230.00	x 7.00
F10270	82.00	x 92.00	x 5.00	F3575	108.00	x 119.00	x 5.50	F6874	145.00	x 157.00	x 6.00	F6195	225.00	x 239.00	x 7.00
F10270	82.00	x 92.00	x 5.00	F13013	110.00	x 120.00	x 5.00	F12559	145.40	x 159.40	x 6.90	F15008	227.40	x 243.40	x 8.00
F14723	82.40	x 87.80	x 3.80	F10805	110.00	x 130.00	x 12.00	F15612	146.00	x 160.00	x 7.00	F16004	228.00	x 242.00	x 7.00
F14964	83.00	x 91.00	x 4.00	F8289	110.50	x 121.16	x 5.30	F11562	148.00	x 162.00	x 7.00	F9661	234.00	x 250.00	x 6.50
F4246A	83.60	x 89.00	x 2.70	F12231	110.50	x 121.80	x 5.40	F9577/2	150.00	x 164.00	x 7.00	F9838	235.00	x 250.00	x 7.50
F13354	85.00	x 96.20	x 5.60	F12210	113.50	x 127.50	x 7.00	F6306/1	151.76	x 165.76	x 7.00	F4827	235.50	x 249.50	x 7.00
F6291/1	85.40	x 95.40	x 5.00	F15088	113.67	x 124.83	x 5.33	F6519/1	152.00	x 159.00	x 3.50	F.....	236.00	x 245.00	x 7.00
F14872	87.00	x 94.00	x 3.50	F15976	115.00	x 122.00	x 3.50	F12562	152.00	x 166.00	x 7.00	F3418	237.00	x 252.00	x 7.00
F8297/1	88.00	x 100.00	x 6.00	F12088	115.00	x 125.00	x 5.00	F9649	153.50	x 167.50	x 7.00	F12422	238.00	x 254.00	x 8.00
F4853	88.26	x 98.92	x 5.33	F15088	115.00	x 125.00	x 5.00	F8448	154.00	x 166.00	x 6.00	F5102	240.07	x 254.70	x 7.00
F2919	90.49	x 101.60	x 5.56	F11563	116.00	x 131.40	x 7.70	F6526/1	158.50	x 175.50	x 8.50	F3861	241.50	x 255.50	x 7.00
F13064	92.00	x 103.00	x 5.50	F13264	116.40	x 129.40	x 6.50	F8748/1	163.00	x 177.00	x 7.00	F5100	242.00	x 256.00	x 7.00
F14065	94.00	x 97.60	x 1.80	F9577/1	117.00	x 131.00	x 7.00	F8947	164.00	x 180.00	x 8.00	F7486	249.70	x 263.70	x 7.00
F8305/1	94.62	x 105.18	x 5.30	F9577/1	117.00	x 131.00	x 7.00	F6307/2	164.47	x 178.45	x 6.90	F7171/2	250.00	x 260.00	x 5.00
F14721	95.00	x 101.60	x 5.00	F8288	120.00	x 130.66	x 5.33	F13533	164.50	x 170.84	x 3.17	F9656	252.00	x 265.00	x 6.50
F8748/2	95.00	x 105.00	x 5.00	F9502	120.02	x 134.00	x 6.99	F16997	168.00	x 180.00	x 6.00	F15188	253.00	x 266.00	x 8.00
F5952	95.00	x 106.00	x 5.50	F11926	120.32	x 125.56	x 2.62	F6325/2	170.81	x 184.10	x 7.00	F5122	253.40	x 267.40	x 7.00
F8176	97.80	x 108.46	x 5.30	F8009/1	126.00	x 133.00	x 3.55	F12415	171.50	x 183.50	x 6.00	F8246	254.00	x 268.00	x 7.00
F6519/2	98.00	x 105.00	x 3.50	F15094	126.36	x 140.36	x 7.00	F8127	177.00	x 191.00	x 7.00	F7758/1	260.00	x 274.00	x 7.00
F6141	99.00	x 110.00	x 5.50	F3860	127.00	x 140.00	x 6.50	F7487	179.70	x 193.70	x 7.00	F6325/1	262.10	x 279.00	x 8.60
F10973	99.20	x 110.60	x 5.70	F8856	129.53	x 143.55	x 7.00	F15153	182.00	x 196.00	x 7.00	F7171/3	268.00	x 280.00	x 6.00
F7085	100.00	x 112.00	x 6.00	F6291/2	129.54	x 140.20	x 5.33	F12746	183.50	x 197.50	x 7.00	F7758/2	280.00	x 294.00	x 7.00
F6306/2	100.97	x 111.63	x 5.30	F8855/1	130.00	x 134.00	x 7.00	F7223	184.00	x 200.00	x 8.00	F8415	284.00	x 298.00	x 6.99
F13099	101.00	x 112.40	x 5.00	F12779	133.42	x 149.22	x 7.90	F4768/B	184.15	x 196.85	x 6.30	F7171	290.00	x 300.00	x 5.00
F7841	103.00	x 113.00	x 5.00	F4526	135.00	x 149.60	x 7.30	F6043	184.50	x 197.50	x 6.50	F.....	316.80	x 330.80	x 7.00
F4768/A	103.19	x 114.30	x 5.56	F15088/	135.89	x 149.87	x 6.99	F8009	186.00	x 200.00	x 7.00	F7171/1	326.00	x 338.00	x 6.00
F9100/2	103.88	x 115.08	x 5.60	F12756	136.50	x 149.20	x 9.00	F12478	189.95	x 200.50	x 5.30	F9139	354.90	x 368.90	x 7.00
F11997	104.15	x 114.75	x 5.33	F6712	136.50	x 150.00	x 6.70	F1278	189.95	x 200.50	x 5.53	F5100/1	367.00	x 381.00	x 7.00
F11997	104.15	x 114.75	x 5.33	F8817	137.00	x 150.00	x 6.50	F9803	190.00	x 204.00	x 7.00	F5101/1	390.00	x 404.00	x 7.00
F12015	104.37	x 115.07	x 5.35	F5359/A	138.40	x 152.40	x 7.00	F6599	197.00	x 210.00	x 6.50	F5100/2	396.00	x 410.00	x 7.00
F2924	104.77	x 114.30	x 4.76	F14037	139.50	x 146.50	x 3.50	F12847	198.00	x 217.00	x 7.00				
F9419	106.00	x 120.00	x 7.00	F8451	139.50	x 151.50	x 5.00	F10271	212.00	x 226.00	x 7.00				







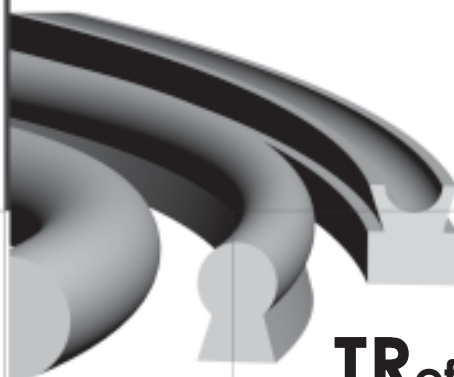
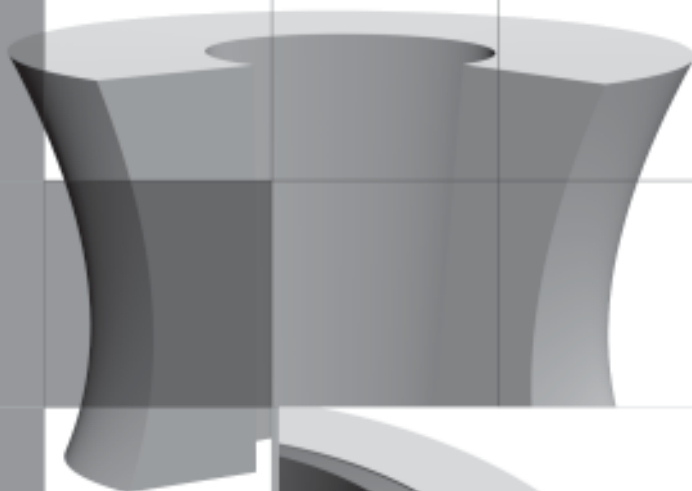

**TR**efilados



**AU<sub>p</sub>**

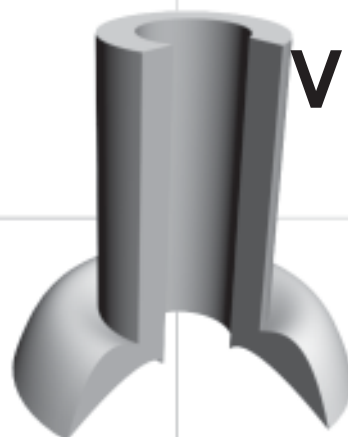

**VE**entosas



**ES**feras



**Dl**afragmas



INCOVE VEDAÇÕES LTDA.

Código	Di x	De x	Ha1 x	Ha2	Código	Di x	De x	Ha1 x	Ha2	Código	Di x	De x	Ha1 x	Ha2
F9914	7.70 x	14.00 x	3.00 x	—	F6430	50.00 x	61.00 x	13.00 x	—	F7689	108.00 x	122.00 x	17.50 x	—
F14345	12.50 x	18.50 x	5.50 x	—	F6583/1	54.00 x	63.50 x	13.00 x	—	F7036	108.00 x	122.00 x	18.00 x	—
F9915	13.00 x	40.00 x	5.00 x	—	F10003	54.00 x	64.00 x	9.00 x	—	F15478	108.00 x	122.00 x	18.00 x	—
F15872	14.00 x	20.00 x	5.50 x	4.50	F10003	54.00 x	64.00 x	9.00 x	—	F6083	117.00 x	131.00 x	18.00 x	—
F8978	14.00 x	20.00 x	7.70 x	—	F6019	54.00 x	64.00 x	13.00 x	—	F14302	118.00 x	130.00 x	12.00 x	—
F9870	15.30 x	25.70 x	8.00 x	—	F6583	54.00 x	64.30 x	13.00 x	—	F14302	118.00 x	130.00 x	12.00 x	—
F10826	15.50 x	21.70 x	7.50 x	—	F5059	58.00 x	68.00 x	9.50 x	—	F1933	123.82 x	138.11 x	19.05 x	—
F10030	16.00 x	22.00 x	5.50 x	—	F14082	58.00 x	68.00 x	13.00 x	—	F10942	126.00 x	139.00 x	10.50 x	—
F9306	18.00 x	26.00 x	10.50 x	—	F7034	58.00 x	68.00 x	13.00 x	—	F10942	126.00 x	139.00 x	10.50 x	—
F10301	20.00 x	28.00 x	10.50 x	—	F8447	60.00 x	81.00 x	11.00 x	—	F5919	126.00 x	140.00 x	12.80 x	—
F7754	20.00 x	28.00 x	10.50 x	—	F10000	63.00 x	75.00 x	11.00 x	—	F7050	126.00 x	140.00 x	18.00 x	—
F13528	22.00 x	30.00 x	7.50 x	—	F10000	63.00 x	75.00 x	11.00 x	—	F9998	135.00 x	149.00 x	12.80 x	—
F4745	22.00 x	30.00 x	9.00 x	—	F8450	63.00 x	75.00 x	15.50 x	—	F14768	135.00 x	149.00 x	18.00 x	—
F10296	22.00 x	30.00 x	10.50 x	—	F918	63.00 x	75.00 x	16.00 x	—	F14768	135.00 x	149.00 x	18.00 x	—
F10296	22.00 x	30.00 x	10.50 x	—	F918	63.00 x	75.00 x	16.00 x	—	F8531	138.00 x	152.00 x	11.00 x	—
F3583	22.22 x	30.16 x	6.35 x	—	F6748	66.00 x	79.00 x	6.50 x	—	F14949	140.00 x	160.00 x	14.00 x	—
F13435	22.50 x	30.60 x	6.70 x	—	F2682	66.67 x	79.37 x	11.11 x	—	F7496	144.00 x	160.00 x	14.50 x	—
F6257	24.00 x	39.00 x	6.00 x	—	F7175	67.00 x	79.00 x	15.50 x	—	F10963	144.00 x	160.00 x	20.05 x	—
F12857	25.00 x	33.00 x	7.00 x	—	F15346	69.00 x	80.00 x	13.00 x	—	F14262	146.00 x	160.00 x	14.50 x	—
F10298	25.00 x	33.00 x	10.50 x	—	F15076	70.00 x	85.00 x	10.00 x	—	F9044	150.00 x	165.00 x	14.00 x	—
F9364	25.00 x	33.00 x	10.50 x	—	F11568	72.00 x	84.00 x	11.00 x	—	F14168	150.00 x	178.00 x	24.50 x	—
F10298	25.00 x	33.00 x	10.50 x	—	F4351	72.00 x	84.00 x	15.50 x	—	F7053	153.00 x	170.00 x	20.50 x	—
F10368	27.00 x	35.00 x	10.50 x	—	F3466	73.00 x	85.00 x	15.00 x	—	F10295	162.00 x	178.00 x	20.50 x	—
F9513	28.00 x	40.00 x	9.00 x	—	F1928	73.02 x	84.14 x	14.29 x	—	F6996	162.00 x	178.20 x	14.50 x	—
F8572	29.60 x	37.00 x	8.00 x	—	F13694	74.00 x	86.30 x	10.50 x	—	F13444	171.00 x	184.00 x	10.50 x	—
F8440	31.00 x	39.00 x	7.00 x	—	F9314	76.00 x	88.00 x	11.00 x	—	F10280	171.00 x	187.00 x	14.50 x	—
F3582	31.75 x	36.51 x	9.52 x	—	F9314	76.00 x	88.00 x	11.00 x	—	F9432	171.00 x	187.00 x	20.50 x	—
F6749	34.00 x	42.00 x	4.00 x	—	F6747	80.00 x	93.00 x	6.50 x	—	F8556	180.00 x	193.00 x	20.50 x	—
F12982	34.00 x	42.00 x	7.50 x	—	F6241	81.00 x	93.00 x	11.00 x	—	F5601	180.00 x	210.00 x	25.00 x	—
F6585	34.00 x	42.00 x	10.40 x	—	F15477	81.00 x	93.00 x	15.50 x	—	F8530	189.00 x	205.00 x	12.80 x	—
F4352	34.00 x	42.00 x	10.50 x	—	F9619	85.00 x	97.00 x	11.00 x	—	F6496	198.00 x	228.00 x	25.00 x	—
F13118	34.00 x	50.50 x	16.00 x	—	F9619	85.00 x	97.00 x	11.00 x	—	F12022	202.00 x	240.00 x	204.00 x	—
F4347	36.00 x	43.00 x	13.00 x	—	F6465	85.00 x	97.00 x	13.00 x	—	F3925	206.00 x	236.00 x	14.00 x	25.00
F10002	36.00 x	46.00 x	9.00 x	—	F15077	85.00 x	97.00 x	15.50 x	—	F5913	225.00 x	235.00 x	25.00 x	—
F9939	36.00 x	46.00 x	9.00 x	—	F6171	90.00 x	102.00 x	11.00 x	—	F9510	225.00 x	255.00 x	25.00 x	—
F9939	36.00 x	46.00 x	13.00 x	—	F5108	90.00 x	102.00 x	12.00 x	—	F12921	247.00 x	260.00 x	8.00 x	—
F10291	36.00 x	46.00 x	13.00 x	—	F7035	90.00 x	102.00 x	15.50 x	—	F12921	247.00 x	260.00 x	10.50 x	—
F15774	36.00 x	46.00 x	13.00 x	—	F8557	90.00 x	102.00 x	15.50 x	—	F14863	260.00 x	290.00 x	25.00 x	—
F9514	36.00 x	50.00 x	12.00 x	—	F15345	92.00 x	100.00 x	13.00 x	—	F6495	270.00 x	300.00 x	25.00 x	—
F4987	36.50 x	47.00 x	12.00 x	—	F9999	99.00 x	113.00 x	12.80 x	—	F13578	292.00 x	305.00 x	10.50 x	—
F9313	40.00 x	50.00 x	9.00 x	—	F9999	99.00 x	113.00 x	12.80 x	—	F13532	292.00 x	322.00 x	10.50 x	—
F4348	40.00 x	50.00 x	13.00 x	—	F12824	99.00 x	113.00 x	18.00 x	—	F13504	292.00 x	322.00 x	25.00 x	—
F3465	42.00 x	52.00 x	13.00 x	—	F15075	100.00 x	115.00 x	10.00 x	—	F14995	315.00 x	345.00 x	25.00 x	20.00
F11548	45.00 x	55.00 x	9.00 x	7.00	F3477	101.60 x	114.30 x	15.87 x	—	F6497	360.00 x	390.00 x	25.00 x	—
F6240	45.00 x	55.00 x	13.00 x	—	F6466	103.00 x	117.00 x	19.00 x	—	F6065	360.00 x	390.00 x	25.00 x	—
F6020	45.00 x	55.00 x	13.00 x	—	F15341	105.00 x	115.00 x	13.00 x	—	F15711	405.00 x	418.00 x	10.50 x	—
F1833	45.00 x	57.00 x	12.00 x	—	F1004	107.00 x	121.40 x	13.50 x	—	F10285	405.00 x	435.00 x	25.00 x	—
F5683	45.00 x	60.00 x	10.30 x	—	F10047	107.00 x	121.40 x	13.50 x	—	F9700	721.40 x	749.34 x	26.97 x	—
F14132	47.50 x	55.30 x	11.11 x	—	F10047	107.00 x	121.40 x	13.50 x	—	F.....	745.00 x	775.00 x	25.00 x	20.00
F8351	49.00 x	59.00 x	9.00 x	—	F1924	107.95 x	122.24 x	17.46 x	—	F.....	745.00 x	775.00 x	25.00 x	20.00
F8351	49.00 x	59.00 x	9.00 x	—	F15342	108.00 x	120.00 x	16.00 x	—	F11993	1150.00 x	1220.00 x	25.00 x	—

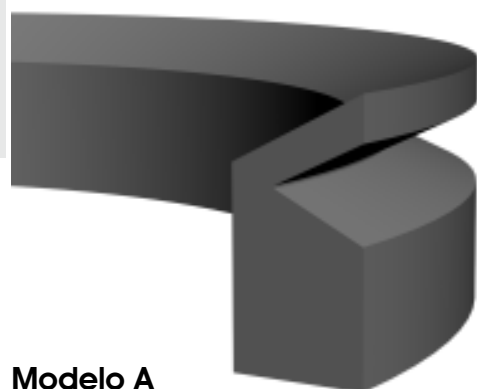
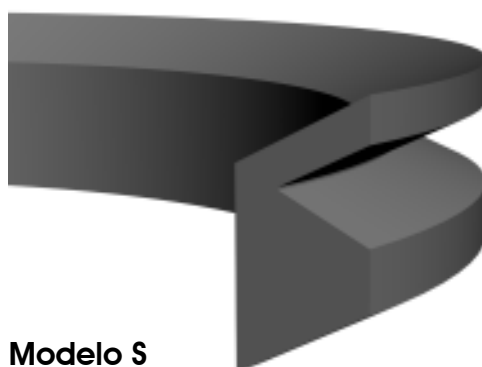
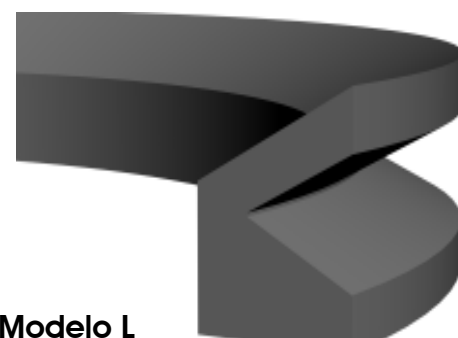
**Modelo A**

**Modelo S**

**Modelo L**



Código	Di x	De x	Esp. x	Ha1 x	Ha2
F14607	12.00 x	26.00 x	— x	22.00 x	—
F15483	37.00 x	37.00 x	— x	57.00 x	—
F15483	37.00 x	37.00 x	57.00 x	— x	—
F15214	— x	38.00 x	— x	20.00 x	—
F15213	— x	38.00 x	— x	23.00 x	—
F15212	— x	38.00 x	— x	29.00 x	—
F15211	— x	38.00 x	— x	39.00 x	—
F15210	— x	38.00 x	— x	43.00 x	—
F15209	— x	38.00 x	— x	61.00 x	—
F14635	26.00 x	38.20 x	7.90 x	19.00 x	51.00
F14814	63.50 x	43.50 x	76.50 x	— x	—
F14612	45.00 x	50.00 x	78.50 x	9.50 x	—
F10334	41.00 x	77.00 x	— x	— x	—
F15890	65.00 x	90.00 x	— x	35.00 x	—
F15539	19.50 x	95.00 x	— x	35.00 x	63.50
F14294	75.00 x	100.00 x	— x	60.00 x	—
F....	— x	— x	— x	— x	—
F15527	— x	— x	— x	— x	—
F14809	— x	— x	— x	— x	—
F14813	— x	— x	— x	— x	—
F13779	— x	— x	— x	— x	—
F13936	— x	— x	— x	— x	—

Código	Di x	De x	Esp. x	Ha1 x	Ha2
F14160	— x	— x	— x	— x	—
F15637	— x	— x	— x	— x	—
F4072	— x	— x	— x	— x	—
—	— x	— x	— x	— x	—
IS 1098	— x	— x	— x	— x	—
IS1105	— x	— x	— x	— x	—
IS1204	— x	— x	— x	— x	—
IS1208	— x	— x	— x	— x	—
IS1250	— x	— x	— x	— x	—
IS1251	— x	— x	— x	— x	—
IS1254	— x	— x	— x	— x	—
IS1504	— x	— x	— x	— x	—
IS1602	— x	— x	— x	— x	—
IS1700	— x	— x	— x	— x	—
IS1759	— x	— x	— x	— x	—
IS1801	— x	— x	— x	— x	—
IS1802	— x	— x	— x	— x	—
IS1905	— x	— x	— x	— x	—
IS2111	— x	— x	— x	— x	—
IS2610	— x	— x	— x	— x	—
IS2711	— x	— x	— x	— x	—
IS3012	— x	— x	— x	— x	—



# Diaphragma

Código	Di x	De x	Esp. x	Ha1 x	Ha2
F15768	3.50 x	7.50 x	38.00 x	3.00 x	17.50
F15901	5.00 x	110.00 x	— x	13.00 x	—
F12307	7.00 x	59.00 x	0.60 x	33.00 x	—
F16609	7.00 x	82.00 x	0.50 x	— x	—
F12764	7.20 x	35.00 x	— x	5.00 x	—
F15771	7.50 x	163.00 x	— x	10.50 x	—
F16903	8.00 x	118.00 x	23.00 x	— x	—
F11645	10.00 x	72.00 x	— x	7.00 x	—
F17255	10.00 x	200.00 x	— x	30.00 x	—
F17209	10.70 x	— x	— x	4.80 x	—
F17084	11.00 x	162.50 x	6.00 x	1.50 x	—
F12735	13.00 x	80.00 x	— x	4.50 x	—
F17254	15.00 x	200.00 x	— x	10.00 x	30.00
F15412	15.87 x	292.10 x	— x	34.50 x	—
F15413	16.00 x	304.00 x	— x	44.00 x	—
F14577	18.80 x	168.00 x	26.10 x	— x	—
F16722	25.40 x	— x	2.40 x	— x	—
F17093	28.00 x	335.00 x	— x	33.00 x	—
F17200	30.60 x	— x	5.20 x	— x	—
F17182	32.00 x	249.00 x	— x	37.00 x	—
F14167	34.00 x	45.00 x	— x	138.00 x	—
F12581	36.00 x	59.50 x	— x	12.70 x	—
F15083	44.00 x	6.00 x	7.00 x	3.00 x	—
F15697	69.00 x	3.40 x	8.00 x	— x	—
F11963	99.30 x	105.60 x	— x	59.00 x	—
F13202	100.47 x	174.00 x	— x	19.00 x	—
F15187	137.00 x	0.30 x	3.00 x	6.00 x	—
F8132	161.92 x	9.52 x	— x	12.70 x	3.18
F14691	180.00 x	350.00 x	75.00 x	12.00 x	15.00
F14979	200.00 x	360.00 x	— x	— x	—
F3658	205.00 x	12.00 x	— x	2.80 x	—
F7751	491.00 x	207.00 x	— x	20.00 x	—
F16657	538.00 x	745.00 x	— x	25.00 x	—
F16622	618.00 x	805.00 x	— x	25.00 x	—
F16633	725.00 x	925.00 x	— x	16.00 x	—

Código	Di x	De x	Esp. x	Ha1 x	Ha2
F16633	725.00 x	925.00 x	— x	16.00 x	—
F13887	— x	81.00 x	— x	6.40 x	26.50
F9714	— x	154.00 x	— x	25.00 x	3.50
F15636	— x	159.50 x	— x	4.50 x	26.70
F6284	— x	185.00 x	— x	2.50 x	19.00
F14218	— x	— x	— x	— x	—
F15259	— x	— x	— x	— x	—
F15269	— x	— x	— x	— x	—
CORT	— x	— x	— x	— x	—
F17187	— x	— x	— x	— x	—
F....	— x	— x	— x	— x	—
F14589	— x	— x	— x	— x	—
F14235	— x	— x	— x	— x	—
F12821	— x	— x	— x	— x	—
F14500	— x	— x	— x	— x	—
PG0297	— x	— x	— x	— x	—
PG0298	— x	— x	— x	— x	—





# TRefilados



INCOVE VEDAÇÕES LTDA.

## Trafilados em:

Viton, silicone e NBR.

Com emenda vulcanizada em silicone atóxico.

Tipo	Di x	De x	Esp. x	Ha1	Tipo	Di x	De x	Esp. x	Ha1	Tipo	Di x	De x	Esp. x	Ha1
CORDAO	— x —	— x —	1.00 x	—	CORDAO	— x —	— x 10.50 x	—	—	CORDAO	— x —	— x 38.10 x	—	—
CORDAO	— x —	— x —	1.50 x	—	CORDAO	— x —	— x 11.00 x	—	—	CORDAO	— x —	— x 50.00 x	—	—
CORDAO	— x —	— x —	2.00 x	—	CORDAO	— x —	— x 11.00 x	—	—	CORDAO	— x —	— x 50.80 x	—	—
CORDAO	— x —	— x —	2.50 x	—	CORDAO	— x —	— x 11.50 x	—	—	TRAFIL	— x —	— x —	—	—
CORDAO	— x —	— x —	2.80 x	—	CORDAO	— x —	— x 12.00 x	—	—	TRAFIL	— x —	— x —	—	—
CORDAO	— x —	— x —	3.00 x	—	CORDAO	— x —	— x 12.00 x	—	—	TRAFIL	— x —	— x —	—	—
CORDAO	— x —	— x —	3.50 x	—	CORDAO	— x —	— x 12.50 x	—	—	TRAFIL	— x —	— x —	—	—
CORDAO	— x —	— x —	3.80 x	—	CORDAO	— x —	— x 13.00 x	—	—	TRAFIL	5.50 x	9.53 x	—	7.00
CORDAO	— x —	— x —	4.00 x	—	CORDAO	— x —	— x 13.50 x	—	—	TRAFIL	13.50 x	19.00 x	—	27.00
CORDAO	— x —	— x —	4.50 x	—	CORDAO	— x —	— x 14.00 x	—	—	TRAFIL	18.00 x	14.00 x	—	—
CORDAO	— x —	— x —	5.00 x	—	CORDAO	— x —	— x 14.50 x	—	—	TIRAS	— x —	— x —	—	—
CORDAO	— x —	— x —	5.00 x	—	CORDAO	— x —	— x 15.00 x	—	—	TIRAS	— x —	— x —	—	—
CORDAO	— x —	— x —	5.00 x	—	CORDAO	— x —	— x 15.50 x	—	—	TIRAS	— x 7.00 x	1.60 x	157.00	—
CORDAO	— x —	— x —	5.50 x	—	CORDAO	— x —	— x 16.00 x	—	—	TIRAS	— x 78.00 x	1.50 x	2.50	—
CORDAO	— x —	— x —	6.00 x	—	CORDAO	— x —	— x 16.50 x	—	—	TIRAS	— x 212.00 x	13.30 x	2.60	—
CORDAO	— x —	— x —	6.00 x	—	CORDAO	— x —	— x 17.00 x	—	—	TIRAS	20.00 x	25.00 x	—	—
CORDAO	— x —	— x —	6.50 x	—	CORDAO	— x —	— x 17.50 x	—	—	TIRAS	61.00 x	— x 2.50 x	9.30	—
CORDAO	— x —	— x —	6.50 x	—	CORDAO	— x —	— x 18.00 x	—	—	TIRAS	61.70 x	2.55 x 9.70 x	45.00	—
CORDAO	— x —	— x —	7.00 x	—	CORDAO	— x —	— x 18.50 x	—	—	TIRAS	95.00 x	— x 24.00 x	14.70	—
CORDAO	— x —	— x —	7.00 x	—	CORDAO	— x —	— x 19.00 x	—	—	TIRAS	145.00 x	42.00 x	—	18.00
CORDAO	— x —	— x —	7.50 x	—	CORDAO	— x —	— x 19.50 x	—	—	TIRAS	150.00 x	— x 2.50 x	5.60	—
CORDAO	— x —	— x —	8.00 x	—	CORDAO	— x —	— x 20.00 x	—	—	TIRAS	166.00 x	2.50 x 6.30 x	—	—
CORDAO	— x —	— x —	8.00 x	—	CORDAO	— x —	— x 21.00 x	—	—	TIRAS	166.50 x	9.60 x 2.50 x	10.00	—
CORDAO	— x —	— x —	8.50 x	—	CORDAO	— x —	— x 22.00 x	—	—	TIRAS	178.00 x	6.00 x 24.00 x	—	—
CORDAO	— x —	— x —	9.00 x	—	CORDAO	— x —	— x 25.00 x	—	—	TIRAS	395.00 x	— x 14.50 x	2.50	—
CORDAO	— x —	— x —	9.50 x	—	CORDAO	— x —	— x 25.40 x	—	—	TIRAS	500.00 x	— x 2.50 x	14.40	—
CORDAO	— x —	— x —	9.50 x	—	CORDAO	— x —	— x 30.00 x	—	—	TIRAS	1870.00 x	38.00 x	—	13.00
CORDAO	— x —	— x —	9.50 x	—	CORDAO	— x —	— x 31.80 x	—	—	TIRAS	1950.00 x	40.00 x 12.50 x	—	—
CORDAO	— x —	— x —	10.00 x	—	CORDAO	— x —	— x 35.00 x	—	—					

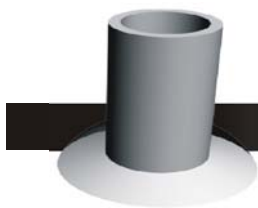

# VEntosa



INCOVE VEDAÇÕES LTDA.

## Ventosa em:

Viton, silicone e NBR.

Código	Di x	De x	Ha1 x	Ha2	Código	Di x	De x	Ha1 x	Ha2	Código	Di x	De x	Ha1 x	Ha2
F....	3.00 x	13.00 x	25.00 x	—	F16879	6.35 x	34.00 x	19.00 x	—	F11856	— x	— x	— x	—
F17117	3.00 x	25.00 x	20.00 x	—	F16629	9.00 x	5.00 x	3.00 x	8.00	F11173	— x	— x	— x	—
F17109	3.00 x	28.00 x	20.00 x	—	F15702	10.00 x	35.00 x	16.00 x	—	F3306	— x	— x	— x	—
F15706	4.00 x	12.00 x	11.00 x	—	F15988	10.00 x	45.00 x	13.00 x	23.00	F3306/1	— x	— x	— x	—
F15707	4.00 x	15.00 x	12.00 x	—	F15701	10.00 x	45.00 x	18.00 x	—	F13803	— x	— x	— x	—
F15705	4.00 x	18.00 x	12.00 x	—	F14159	10.00 x	60.00 x	22.00 x	—	F....	— x	— x	— x	—
F15704	4.00 x	22.00 x	13.00 x	—	F3566	13.00 x	35.40 x	7.20 x	14.50	F15796	— x	— x	— x	—
F13818	5.00 x	12.30 x	16.00 x	—	F14266	13.50 x	26.50 x	— x	30.50	F....	— x	— x	— x	—
F15936	5.00 x	27.00 x	9.00 x	—	F12467	25.40 x	45.50 x	6.00 x	—	F....	— x	— x	— x	—
F15764	5.70 x	29.50 x	13.00 x	—	F12468	28.50 x	51.00 x	6.00 x	—	F17207	— x	— x	— x	—
F16628	6.00 x	25.00 x	8.00 x	25.00	F....	— x	— x	— x	—	F14597	— x	— x	— x	—
F16627	6.00 x	30.00 x	8.00 x	30.00	F....	— x	— x	— x	—	F15453	— x	— x	— x	—
F15703	6.00 x	30.00 x	17.00 x	—	F....	— x	— x	— x	—					
F16625	6.00 x	35.00 x	8.00 x	35.00	F....	— x	— x	— x	—					



# C Arretel



INCOVE VEDAÇÕES LTDA.

Código	Di x	De x	Ha1 x	Ha2
F5810	6.00 x	28.00 x	16.00 x	—
F5811	8.00 x	30.00 x	16.00 x	—
F13495	11.50 x	32.00 x	16.00 x	—
F13495	11.50 x	32.00 x	16.00 x	—
F2245	12.50 x	45.00 x	16.00 x	—
F2245	13.00 x	32.00 x	16.00 x	—
F2246	13.50 x	45.00 x	16.00 x	—
F14514	14.15 x	23.80 x	3.80 x	—
F8790	18.00 x	42.00 x	16.00 x	—
F7217	18.50 x	45.00 x	16.00 x	—
F1397	19.50 x	41.00 x	16.00 x	—
F1397	19.50 x	41.00 x	16.00 x	—
F4531	19.50 x	45.00 x	16.00 x	—
F4531	19.50 x	45.00 x	16.00 x	—
F8791	20.00 x	42.00 x	16.00 x	—
F2240	22.50 x	52.00 x	16.00 x	—
F2240	22.50 x	52.00 x	16.00 x	—
F3842	25.40 x	33.34 x	4.76 x	—
F2239	25.50 x	52.00 x	16.00 x	—
F13706	27.30 x	52.00 x	16.00 x	—
F4315	29.00 x	52.00 x	16.00 x	—
F4315	29.00 x	52.00 x	16.00 x	—
F4252	32.00 x	52.00 x	16.00 x	—
F4252	32.00 x	52.00 x	16.00 x	—
F4315	32.30 x	58.00 x	16.00 x	—
F2749	32.30 x	64.00 x	15.00 x	—

Código	Di x	De x	Ha1 x	Ha2
F2078	33.90 x	58.00 x	16.00 x	—
F2822	38.30 x	64.00 x	16.00 x	—
F2822	38.30 x	64.00 x	16.00 x	—
F1809	38.60 x	67.00 x	16.00 x	—
F2748	42.00 x	67.00 x	16.00 x	—
F7778	43.20 x	68.00 x	16.00 x	—
F2750	44.45 x	72.00 x	16.00 x	—
F3387	45.00 x	67.00 x	16.00 x	—
F1734	46.00 x	73.00 x	16.00 x	—
F2473	48.00 x	73.00 x	16.00 x	—
F4253	49.00 x	73.00 x	16.00 x	—
F4253	49.00 x	73.00 x	16.00 x	—
F7777	49.30 x	73.50 x	16.00 x	—
F8800	50.00 x	60.00 x	7.00 x	12.00
F1384	51.30 x	73.50 x	16.00 x	—
F1384	51.30 x	73.50 x	16.00 x	—
F9291	53.00 x	73.00 x	16.00 x	—
F9232	58.00 x	90.00 x	20.00 x	—
F9232	58.00 x	90.00 x	20.00 x	—
F5716	60.80 x	90.00 x	20.00 x	—
F5716	60.80 x	90.00 x	20.00 x	—
F1567	60.80 x	91.20 x	20.00 x	—
F7776	61.50 x	91.00 x	19.50 x	—
F7776	61.50 x	91.00 x	19.50 x	—
F1568	64.00 x	91.20 x	20.00 x	—
F8836	64.00 x	91.20 x	20.00 x	—

Código	Di x	De x	Ha1 x	Ha2
F1568	64.00 x	91.20 x	20.00 x	—
F1568	64.00 x	91.20 x	20.00 x	—
F2004	70.50 x	96.00 x	22.00 x	—
F5714	73.50 x	103.00 x	20.00 x	—
F7779	74.00 x	104.00 x	21.50 x	—
F6062/3	74.50 x	103.00 x	20.00 x	—
F7779	74.50 x	104.50 x	21.50 x	—
F6062/2	75.50 x	103.00 x	20.00 x	—
F6062/1	76.50 x	103.00 x	20.00 x	—
F450	77.50 x	95.00 x	12.00 x	—
F1359	77.50 x	105.00 x	21.00 x	—
F1359	77.50 x	105.00 x	21.00 x	—
F4125	84.00 x	130.00 x	20.00 x	—
F13464	84.20 x	120.00 x	20.50 x	—
F5715	89.50 x	130.00 x	25.00 x	—
F1820	90.00 x	130.00 x	20.00 x	—
F9481	90.50 x	131.50 x	20.50 x	—
F1821	101.50 x	140.00 x	20.00 x	—
F13496	103.60 x	142.00 x	20.50 x	—
F13496	103.60 x	142.00 x	20.50 x	—
F5698	114.80 x	156.00 x	25.00 x	—
F5711/1	140.20 x	180.00 x	25.00 x	—
F5711/2	141.80 x	180.00 x	25.00 x	—
F5674/3	165.50 x	220.00 x	25.00 x	—
F5674/2	168.30 x	220.00 x	25.00 x	—
F5674/1	177.80 x	220.00 x	25.00 x	—



# AU (anel de união)



INCOVE VEDAÇÕES LTDA.

Código	Di x	De x	Ha1 x	Ha2
F15587	4.30 x	7.00 x	1.70 x	—
F15469	5.30 x	9.00 x	1.00 x	2.00
F15376	6.50 x	10.00 x	1.00 x	1.70
F9816	6.50 x	11.00 x	1.00 x	—
F15998	7.00 x	10.20 x	1.70 x	—
F2638	8.00 x	15.80 x	0.75 x	—
F10220	8.00 x	19.00 x	1.50 x	—
F3940	8.50 x	14.50 x	1.30 x	—
F1001	8.50 x	15.20 x	1.50 x	—
F10245	9.00 x	17.20 x	1.00 x	—
F9123	9.30 x	13.30 x	1.00 x	—
F8458	10.00 x	15.80 x	2.00 x	—
F4150	10.50 x	19.50 x	2.10 x	—
13058	10.70 x	—	1.50 x	2.30
F10359	11.80 x	18.50 x	2.00 x	3.00
F10207	11.80 x	18.50 x	2.00 x	—
F1002	12.70 x	17.80 x	1.50 x	—
F4567	13.00 x	18.00 x	2.80 x	—
F10337	13.00 x	20.60 x	2.00 x	—
F1003	13.80 x	22.30 x	1.80 x	—
F13676	14.00 x	18.70 x	2.00 x	3.00
F3647	15.00 x	20.70 x	1.50 x	—
F8590	16.00 x	22.70 x	2.00 x	—

Código	Di x	De x	Ha1 x	Ha2
F3694	16.00 x	24.00 x	1.50 x	—
F12200	16.50 x	24.00 x	1.20 x	2.20
F2534	17.00 x	22.40 x	2.00 x	—
F15642	17.00 x	24.00 x	1.50 x	—
F1004	18.00 x	22.80 x	1.20 x	—
F10354	18.00 x	24.70 x	2.20 x	—
F9434	18.00 x	27.00 x	2.00 x	—
F13117	18.70 x	26.00 x	1.50 x	—
F3024	19.05 x	26.99 x	2.38 x	—
F4565	19.50 x	24.00 x	3.00 x	—
F10336	20.50 x	28.50 x	2.50 x	—
F8588	20.70 x	28.00 x	2.50 x	—
F4568	20.80 x	26.00 x	2.80 x	—
F10141	21.50 x	26.80 x	1.50 x	—
F2891	21.50 x	28.60 x	1.50 x	—
F11100	23.00 x	32.00 x	1.50 x	2.50
F10142	24.00 x	33.00 x	1.50 x	—
F12635	24.70 x	32.00 x	2.50 x	3.50
F3213	24.70 x	33.00 x	2.00 x	3.00
F3587	25.40 x	35.00 x	2.40 x	—
F2535	26.00 x	35.00 x	1.50 x	—
F4570	26.30 x	32.00 x	2.80 x	—
F9744	26.70 x	35.00 x	2.50 x	—

Código	Di x	De x	Ha1 x	Ha2
F13509	27.00 x	35.00 x	2.50 x	3.20
F16815	27.00 x	35.00 x	2.50 x	3.50
F9744-1	27.20 x	36.00 x	2.50 x	—
F3026	28.58 x	30.16 x	2.50 x	3.50
F3023	28.58 x	36.51 x	2.38 x	—
F12726	32.60 x	41.50 x	2.10 x	3.00
F11342	32.60 x	41.50 x	2.50 x	—
F16789	32.60 x	41.50 x	3.00 x	4.00
F4569	33.00 x	39.00 x	3.00 x	—
F10263	33.40 x	41.50 x	2.80 x	—
F11911	33.50 x	43.00 x	3.50 x	—
F3214	33.70 x	42.00 x	2.20 x	—
F6368	36.00 x	46.00 x	2.00 x	—
F6122	36.80 x	42.80 x	3.20 x	—
F4571	41.80 x	49.00 x	2.80 x	—
F10265	42.00 x	53.00 x	3.50 x	—
F11913	42.90 x	50.70 x	3.00 x	—
F12469	46.00 x	56.00 x	3.00 x	4.00
F4428	48.00 x	53.00 x	3.50 x	—
F11912	50.80 x	63.50 x	—	—
F13803	52.00 x	63.00 x	2.80 x	—
F6531	53.00 x	64.50 x	3.00 x	—
F10679	76.00 x	90.00 x	4.00 x	—





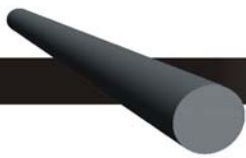

## TÁrugo



INCOVE VEDAÇÕES LTDA.

Em poliuretano, nylon, PTFE e NBR.

Código	Di	x	De	x	Ha1	Código	Di	x	De	x	Ha1	Código	Di	x	De	x	Ha1
21821	—	x	1.40	x	300.00	21840	—	x	60.00	x	100.00	21855	5.00	x	15.00	x	400.00
21861	—	x	5.00	x	8.00	21913	—	x	65.00	x	300.00	21897	5.00	x	15.00	x	400.00
21542	—	x	25.40	x	150.00	21667	—	x	70.00	x	150.00	25081	22.00	x	—	x	300.00
21564	—	x	25.40	x	200.00	24827	—	x	80.00	x	1.00	22093	25.40	x	—	x	100.00
21524	—	x	25.40	x	300.00	21770	—	x	85.00	x	7.00	22102	30.00	x	—	x	100.00
21681	—	x	25.40	x	300.00	21565	—	x	90.00	x	150.00	22115	30.16	x	—	x	300.00
21577	—	x	30.00	x	1.00	21980	—	x	90.00	x	150.00	22009	45.00	x	—	x	100.00
21839	—	x	40.00	x	300.00	21631	—	x	90.00	x	200.00	22064	60.00	x	—	x	300.00
22132	—	x	45.00	x	150.00	21523	—	x	101.60	x	150.00	22010	65.00	x	—	x	150.00
21541	—	x	45.00	x	300.00	21799	—	x	105.00	x	150.00	22050	70.00	x	—	x	300.00
21798	—	x	50.80	x	1.00	21979	—	x	120.00	x	150.00	24198	100.00	x	—	x	25.40
22181	—	x	50.80	x	150.00	21996	—	x	120.00	x	200.00	24199	100.00	x	—	x	25.40
22223	—	x	50.80	x	300.00	21521	—	x	130.00	x	100.00	22051	150.00	x	—	x	300.00
21513	—	x	55.00	x	150.00	21662	—	x	250.00	x	200.00	22028	300.00	x	—	x	150.00
21506	—	x	60.00	x	—	21566	—	x	300.00	x	40.00						



## ESfera



INCOVE VEDAÇÕES LTDA.

De	Código	De	Código	De	Código
3.17	—	25.40	—	50.40	F11636
6.35	—	28.57	—	50.50	F11550
12.70	—	31.80	F14533	50.80	—
14.00	F14681	37.93	—	67.50	F15409
15.87	—	41.27	—	71.50	F15408



## SAnfona



INCOVE VEDAÇÕES LTDA.

Código	Di	x	De	x	Ha1	Código	Di	x	De	x	Ha1	Código	Di	x	De	x	Ha1
F13246	—	x	—	x	—	F7788	10.00	x	25.00	x	45.00	F14884	32.00	x	100.00	x	50.00
F16902	8.40	x	33.00	x	34.00	F8584	12.00	x	24.00	x	50.00	F.....	35.00	x	47.00	x	300.00
F16901	8.50	x	30.70	x	31.00												



## ACoplamento



INCOVE VEDAÇÕES LTDA.

Código	Di	x	De	x	Ha1	Código	Di	x	De	x	Ha1	Código	Di	x	De	x	Ha1
—	26.00	x	65.00	x	18.00	F14400	—	x	—	x	—	F11312	—	x	—	x	—
F15053	—	x	—	x	—	GR 10	—	x	—	x	—	F17165	—	x	—	x	—
F17164	—	x	—	x	—												



# Retentores



INCOVE VEDAÇÕES LTDA.

## Tabela de tolerância à componentes químicos

PROPRIEDADES	NATURAL	NITRÍLICA	*	*					*		
		NITRÍLICA (BUNA N)	NEOPRENE	SILICONE	HYPALON	EPDM	POLIURETANO	POLIACRÍLICA	VITON	PTFE	COURO
CLASSIFICAÇÃO DO MATERIAL	BF/BG/BK										
ASTM D-200 SAE J200	NR/AA	CH/NRB	+BC/BE	SI/GE	CE	CA	AU/BG	DF/DH	HK	PTFE	-
Resistência a Tração (PSI)	+de 3000	-de 1000	+de 3000	-de 1500	+de 1500	-de 1000	+de 4000	-de 1000	1200	-	-
Borracha Pura	+de 3000	+de 2000	+de 3000	+de 1500	0	2000	-	+de 1000	1500a 3000	-	-
Material com negro de fumo											
FAIXA DUREZA D10	30 - 90	40 - 95	40 - 95	40 - 85	40 - 95	30 - 90	60 - 98	45 - 90	50 - 90	50 - 65 shore D	-
PESO ESPECÍFICO	0,93	1	1,23	1,14 a 2,05	1,2	0,86	1,06	1,07	1,8	-	-
ADERÊNCIA A METAIS	E	E	E	E	E	R	MB	R	Rp/B	-	-
ADERÊNCIA A TECIDOS	E	B	E	E	B	B	B	-	B	-	-
RESISTÊNCIA AO RASGO	MB	R	B	M	R	R	+MB	R	Rp/B	-	-
RESISTÊNCIA A ABRASÃO	E	B	E	M	E	Bp/E	E	R	B	EX	E
DEFORMAÇÃO POR COMPRESSÃO	B	B	Rp/R	R	R	B	B	B	E	-	-
Resistência à Ácidos											
Diluídos	Rp/B	B	E	E	E	E	R	M	Rp/E	EX	R
Concentrados	Rp/B	B	B	R	B	B	M	M	E	EX	M
Resistência a Solventes											
Hydrocarbonetos alifáticos	M	E	Rp/B	M	Rp/B	M	+MB	B	E	EX	R
Hydrocarbonetos aromáticos	M	B	R	M	R	M	B	M	E	EX	R
Oxigenados (acetonas, etc.)	B	M	Mp/R	R	Mp/R	E	M	M	M	EX	B
Solventes de laca	M	R	M	M	M	Mp/R	M	M	M/R	EX	R
Resistência à: Inchaço em óleo lubrificante											
Gasolina	M	MB	B	R	B	M	MB	E	E	EX	R
Óleos animais e vegetais	M	E	B	R	B	M	R	Rp/B	E	EX	B
Absorção à água	Mp/B	MB	B	Bp/E	B	Bp/E	E	-	E	EX	R
Oxidação	MB	B	B	E	B	E	B	M	MB	EX	B
Ozônio	B	B	MB	E	E	E	E	R	+E	EX	E
Envelhecimento pelo sol	M	R	MB	E	+E	+E	E	MB	+E	EX	R
Envelhecimento pelo calor											
Baixas temperaturas	M	M	MB	E	+E	+E	B	M	+E	EX	M
Chama	M	B	B	+E	MB	E	B	MB	+E	EX	B
	MB	Rp/B	B	+E	B	E	-	M	Rp/B	-	-
	M	M	B	Rp/B	B	M	R	M	E	-	-

M - MAU R - REGULAR B - BOM MB - MUITO BEM E - EXCELENTE

\* Produtos exclusivos da marca e qualidade DU'PONT

# Retentores



INCOVE VEDAÇÕES LTDA.

**15B**  
Uma vedação de borracha com mola, corpo de metal, blindado.

**15BA**  
Uma vedação de borracha com mola, corpo de metal, aberto em um dos lados.

**15BB**  
Uma vedação de borracha com mola, corpo de metal, revestido de borracha.

**15JM**  
Uma vedação de borracha com mola, corpo de metal, revestido de metal.

**15JML**  
Uma vedação de borracha com mola, corpo de metal, revestido de metal.

**15C**  
Uma vedação de borracha com mola, corpo de metal, blindado.

**12B**  
Uma vedação de borracha, com mola, uma vedação de borracha, sem mola, corpo de metal, blindado.

**12BA**  
Uma vedação de borracha, com mola, uma vedação de borracha, sem mola, corpo de metal, aberto em um dos lados.

**12JM**  
Uma vedação de borracha com mola, uma vedação de borracha, sem mola, corpo de metal, revestido de metal.

**12JML**  
Uma vedação de borracha, com mola, uma vedação de borracha, sem mola, corpo de metal, revestido de metal.

**12BB**  
Uma vedação de borracha com mola, uma vedação de borracha, sem mola, corpo de metal, revestido de metal.

**12BC**  
Uma vedação de borracha, com mola, uma vedação de borracha, sem mola, corpo de metal, blindado.

**12CC**  
Uma vedação de couro, com mola, uma vedação de couro, sem mola, corpo de metal, blindado.

**14B**  
Uma vedação de borracha, sem mola, corpo de metal, blindado.

**14BA**  
Uma vedação de borracha, sem mola, corpo de metal, aberto em um dos lados.

**14BB**  
Uma vedação de borracha, sem mola, corpo de metal, revestido de borracha.

**Rasp**  
Uma vedação de borracha, sem mola, corpo de metal, com vedação mais alta que o corpo.

**14JM**  
Uma vedação de borracha, com mola, corpo de metal, revestido de metal.

**14JML**  
Uma vedação de borracha, com mola, corpo de metal, revestido de metal.

**14C**  
Uma vedação de couro, com mola, uma vedação de couro, sem mola, corpo de metal, blindado.

**13B**  
Uma vedação de borracha, com mola, uma vedação de borracha, sem mola, corpo de metal, blindado.

**13BB**  
Uma vedação de borracha, com mola, uma vedação de borracha, sem mola, corpo de metal, revestido de borracha.

**13BC**  
Uma vedação de borracha, com mola, uma vedação de couro, sem mola, corpo de metal, blindado.

**13CC**  
Uma vedação de couro, com mola, uma vedação de couro, sem mola, corpo de metal, blindado.

**11BF**  
Uma vedação de feltro, com mola, uma vedação de feltro, corpo de metal, blindado.

**11BAF**  
Uma vedação de feltro, com mola, uma vedação de feltro, corpo de metal, aberto em um dos lados.

**11FB**  
Uma vedação de feltro, com mola, uma vedação de feltro, corpo de metal, blindado.

**C12**  
Um raspador de couro sem mola e uma vedação de couro com mola e corpo de metal blindado.

**11CF**  
Uma vedação de feltro, com mola, uma vedação de feltro, corpo de metal, blindado.

**17B**  
Duas vedações opostas de borracha, com molas corpo de metal blindado.

**17BA**  
Duas vedações opostas de borracha, com molas corpo de metal aberto.

**17BB**  
Duas vedações opostas de borracha, com molas corpo de metal revestido.

**17CC**  
Duas vedações opostas de couro, com molas corpo de metal blindado.

**19B**  
Duas vedações opostas de borracha, com molas, corpo de metal blindado.

**19BA**  
Duas vedações no mesmo sentido, de borracha, com molas, corpo de metal aberto em um dos lados.

**112B**  
Um raspador de br sem mola, uma vedação de br com mola e corpo de metal fechado.

# Retentores



INCOVE VEDAÇÕES LTDA.

**19CC**  
Duas vedações no mesmo sentido, de couro, com molas, corpo de metal blindado.

**155B**  
Uma vedação de borracha com mola, corpo de metal blindado duas alturas.

**113F**  
Uma vedação de feltro e metal blindado.

**1800B**  
Uma vedação de borracha com mola, corpo de metal blindado porém para vedação externa.

**1800BA**  
Uma vedação de borracha com mola, corpo de metal aberto em um dos lados, porém para vedação externa.

**1813B**  
Uma vedação de borracha sem mola, corpo de metal blindado para a vedação externa.

**1800C**  
Uma vedação de couro com mola, corpo de metal blindado porém para vedação externa.

**TDUO**  
Duas vedações opostas com ou sem mola para êmbolos hidráulicos e pneumáticos.

**U001**

**U002**

**U003**

**U004**

**U004A**

**U005**

**U006**

**U007**

**U008**

**U009**

**U010**

**U011**

**U012**

**U013**

**U014**

**U015**

**U016**

**U017**

**U018**

**U019**

**U020**

**U021**

**U022**

**U023**

**U024**

**U025**

**U026**

**U027**

**U028**

**U029**

**U030**

**U031**

**U032**

**U033**

**U034**

**U035**

**U036**

**U037**

**U038**

**U039**

# Gaxetas



INCOVE VEDAÇÕES LTDA.

**U040**

**U041**

**U042**

**U043**

**U044**

**U045**

**U046**

**U047**

**U048**

**U049**

**U050**

**U051**

**U052**

**U053**

**U054**

**U055**

**U056**

**U057**

**U058**

**U059**

**U060**

**U061**

**U062**

**U063**

**U064**

**U065**

**U066**

**U067**

**U068**

**U069**

**U070**

**U071**

**U072**

**U073**

**U074**

**U075**

**U076**

**U077**

**U078**

**U079**

**U080**

**U081**

**U082**

**U083**

**U084**

**U085**

**U086**

**U087**

**U088**

**U089**

**U090**

**U091**

**U092**

**U093**

**U094**

**U095**

**U096**

**U097**

**U098**

**U099**

**U100**

**U101**

**U102**

**U103**

**U104**

**W**

**CH**  
Chevron

**J**

**V**

**C**

